

Canon

PowerShot A3300 IS
PowerShot A3200 IS
PowerShot A2200

Camera User Guide

- Make sure you read this guide, including the Safety Precautions before using the camera.
- Reading this guide will help you learn to use the camera properly.
- Store this guide safely so that you can use it in the future.

ENGLISH

Checking the Package Contents

Check if the following items are included in your camera package.
If anything is missing, contact the retailer where you purchased the camera.



Camera

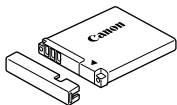

Battery Pack NB-8L
(with Terminal Cover)



Battery Charger
CB-2LA/CB-2LAE



Interface Cable
IFC-400PCU



Wrist Strap
WS-800

A3300 IS
A3200 IS

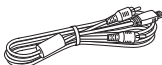

AV Cable
AVC-DC400

A2200



AV Cable
AVC-DC300



Getting Started



DIGITAL CAMERA
Solution Disk



Warranty
Card

Using the PDF Manuals

The following PDF manuals are included in the Readme folder of the CD-ROM:
When the software is installed on your computer, the PDF manuals will be copied to the computer and you can refer to them by clicking the shortcuts on the desktop.

- **Camera User Guide (This Guide)**

Once you have mastered the basics, use the camera's many features to shoot more challenging photos.

- **Software Guide**

Read when you want to use the included software.



- A memory card is not included.
- Adobe Reader is required to view the PDF manuals.

Read This First

Test Shots and Disclaimer

Take some initial test shots and play them back to make sure the images were recorded correctly. Please note that Canon Inc., its subsidiaries and affiliates, and its distributors are not liable for any consequential damages arising from any malfunction of a camera or accessory, including memory cards, that results in the failure of an image to be recorded or to be recorded in a way that is machine readable.

Warning Against Copyright Infringement

The images recorded with this camera are intended for personal use. Do not record images that infringe upon copyright laws without the prior permission of the copyright holder. Please be advised that in certain cases the copying of images from performances, exhibitions, or commercial properties by means of a camera or other device may contravene copyright or other legal rights even if the image was shot for personal use.

Warranty Limitations

This camera's warranty is only effective in the country of sale. If there is a problem with the camera while abroad, please return it to the country of sale before proceeding with a warranty claim to a Canon Customer Support Help Desk. For Canon Customer Support contacts, please see the customer support list supplied with your camera.

LCD Monitor (Screen)

- The LCD monitor is produced with extremely high-precision manufacturing techniques. More than 99.99% of the pixels operate to specification, but occasionally non-performing pixels may appear as bright or dark dots. This is not a malfunction and has no effect on the recorded image.
- The LCD monitor may be covered with a thin plastic film for protection against scratches during shipment. If so, remove the film before using the camera.

Camera Body Temperature

Please take care when operating the camera for an extended period as the camera body may become warm. This is not a malfunction.

What Do You Want to Do?

Shoot



- Shoot, leaving it to the camera to make settings24
- Just take pictures (Easy mode).....29

Take good people shots



Portraits
(p. 68)



Kids and pets
(p. 69)



At the beach
(p. 69)



Against snow
(p. 70)

Shoot various other scenes



Landscape
(p. 69)



Low Light
(p. 69)



Foliage
(p. 69)



Fireworks
(p. 70)

Shoot with special effects



Fish-eye Effect
(p. 73)



Miniature Effect
(p. 74)



Toy Camera Effect
(p. 75)



Monochrome
(p. 76)



Super vivid colors
(p. 73)



Poster Effect
(p. 73)

- Shoot in Discreet mode72
- Adjust image settings when shooting (Live View Control)71
- Focus on faces24, 68, 98
- Shoot in places where I cannot use the flash
(turn off the flash)56
- Take pictures with me in them too (self-timer)60, 62, 80
- Insert the date and time into my shots59

View

- Look at my pictures 27
- Easy playback (Easy Mode)..... 29
- Automatically play back pictures (slideshow)..... 116
- Look at my pictures on a TV 120
- Look at my pictures on a computer..... 34
- Quickly search pictures 114, 115
- Erase pictures 28, 125

**Shoot/View Movies**

- Shoot movies 30
- View movies 32

**Print**

- Easily print pictures 138

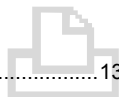
**Save**

- Save images to a computer 34

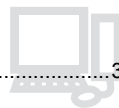
**Other**

- Turn off sounds 50
- Use the camera abroad..... 39, 155
- Understand what is displayed on the screen 171



Table of Contents

Chapters 1 – 3 explain the basic operations and frequently used functions of this camera. Chapters 4 onward explain the advanced functions, letting you learn more as you read each chapter.

Checking the Package Contents	2
Read This First	3
What Do You Want to Do?	4
Table of Contents	6
Conventions Used in This Guide	9
Safety Precautions.....	10

1 Getting Started 13

Charging the Battery	14
Compatible Memory Cards (Sold Separately).....	16
Inserting the Battery and Memory Card.....	16
Setting the Date and Time	19
Setting the Display Language.....	21
Formatting Memory Cards	22
Pressing the Shutter Button.....	23
Taking Pictures (Smart Auto).....	24
Viewing Images	27
Erasing Images.....	28
Shooting or Viewing Images in Easy Mode.....	29
Shooting Movies	30
Viewing Movies.....	32
Transferring Images to a Computer for Viewing.....	34
Accessories	38
Separately Sold Accessories	39

2 Learning More 41

Components Guide.....	42
Screen Display.....	46
Indicator	47
FUNC. Menu – Basic Operations ...	48

MENU – Basic Operations	49
Changing the Sound Settings	50
Adjusting the Screen Brightness	52
Returning the Camera to Default Settings	53
Power Saving Function (Auto Power Down).....	54
Clock Functions.....	54

3 Shooting with Commonly Used Functions 55

Turning the Flash Off	56
Zooming in More Closely on Subjects (Digital Zoom).....	57
Inserting the Date and Time.....	59
Using the Self-Timer	60
Changing the Recording Pixel Setting (Image Size)	63
Changing the Compression Ratio (Image Quality)	63

4 Adding Effects and Shooting in Various Conditions 67

Shooting in Various Conditions	68
Easily Changing the Brightness and Color When Shooting (Live View Control).....	71
Shooting in Discreet Mode.....	72
Adding Effects and Shooting (Creative Filters)	72
Detecting a Face and Shooting (Smart Shutter)	77
Shooting Long Exposures	81

5 Choosing Settings Yourself.....	83
Shooting in Program AE	84
Adjusting the Brightness (Exposure Compensation)	85
Turning the Flash On	85
Adjusting the White Balance	86
Changing the ISO Speed	87
Correcting the Brightness and Shooting (i-Contrast).....	88
Continuous Shooting.....	89
Changing the Tone of an Image (My Colors).....	90
Shooting Close-ups (Macro)	91
Shooting Far Away Subjects (Infinity).....	91
Changing the AF Frame Mode.....	92
Choosing the Subject to Focus On (Tracking AF).....	94
Magnifying the Focal Point.....	95
Shooting with the AF Lock	96
Shooting with Servo AF	97
Choosing the Person to Focus On (Face Select)	98
Changing the Metering Method.....	99
Shooting with the AE Lock.....	100
Shooting with the FE Lock	100
Shooting with Slow Synchro	101
Red-Eye Correction	102
Checking for Shut Eyes	103
Shooting Using a TV as the Display.....	103
6 Using Various Functions for Shooting Movies	105
Changing the Movie Mode.....	106

Shoot Movies That Look Like a Miniature Model (Miniature Effect).....	106
Changing the Image Quality.....	108
AE Lock/Exposure Shift.....	109
Other Shooting Functions.....	110
Editing	111

7 Using Various Playback and Editing Functions

Quickly Searching Images.....	114
Searching for Images Using the Jump Display.....	115
Viewing Slideshows.....	116
Checking the Focus.....	117
Magnifying Images	118
Displaying Various Images (Smart Shuffle).....	119
Changing Image Transitions	120
Viewing Images on a TV	120
Protecting Images	122
Erasing All Images	125
Tagging Images as Favorites	127
Organizing Images by Category (My Category)	128
Rotating Images	130
Resizing Images.....	131
Trimming	132
Correcting the Brightness (i-Contrast)	134
Correcting the Red-Eye Effect.....	135

8 Printing.....

Printing Images	138
Choosing Images for Printing (DPOF).....	145

9 Customizing Camera Settings.....	149	Troubleshooting	165
Changing Camera Settings.....	150	List of Messages That Appear on the Screen.....	169
Changing Shooting Function Settings.....	157	Information Displayed on the Screen.....	171
Changing Playback Function Settings.....	161	Handling Precautions	175
10 Useful Information	163	Functions Available in Each Shooting Mode.....	176
Using Household Power	164	Menus	184
		Specifications	194
		Index	198

Conventions Used in This Guide

- Icons are used in the text to represent the camera buttons and dials.
- Language that displays on the screen appears inside [] (square brackets).
- The directional buttons and FUNC./SET button are represented by the following icons.

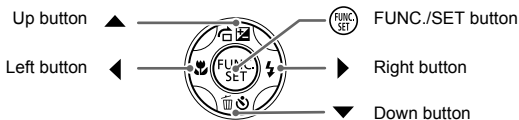

- ⓘ : Things you should be careful about
- ❓ : Troubleshooting tips
- ⚙️ : Hints for getting more out of your camera
- 📝 : Supplemental information
- (p. xx): Reference pages ("xx" stands for a page number)
- This guide assumes all functions are at their default settings.
- The various types of memory cards that can be used in this camera are collectively referred to as memory cards in this guide.
- Functions that differ depending on the camera model are indicated with the following icons:

A3300 IS Functions and precautions for the PowerShot A3300 IS only.

A3200 IS Functions and precautions for the PowerShot A3200 IS only.

A2200 Functions and precautions for the PowerShot A2200 only.

Explanations without these icons apply to all three models.

- PowerShot A3300 IS screenshots and illustrations are used for the explanations in this guide.

Safety Precautions

- Before using the product, please ensure that you read the safety precautions described below. Always ensure that the product is used correctly.
- The safety precautions noted on the following pages are intended to prevent injuries to yourself and other persons, or damage to the equipment.
- Be sure to also check the guides included with any separately sold accessories you use.



Warning

Denotes the possibility of serious injury or death.

- **Do not trigger the flash in close proximity to people's eyes.**

Exposure to the intense light produced by the flash could damage eyesight. In particular, remain at least one meter (39 inches) away from infants when using the flash.

- **Store this equipment out of the reach of children and infants.**

Strap: Putting the strap around a child's neck could result in asphyxiation.

- **Use only recommended power sources.**
- **Do not attempt to disassemble, alter or apply heat to the product.**
- **Avoid dropping or subjecting the product to severe impacts.**
- **To avoid the risk of injury, do not touch the interior of the product if it has been dropped or otherwise damaged.**
- **Stop using the product immediately if it emits smoke, a strange smell, or otherwise behaves abnormally.**
- **Do not use organic solvents such as alcohol, benzene, or thinner to clean the equipment.**
- **Do not let the product come into contact with water (e.g. sea water) or other liquids.**
- **Do not allow liquids or foreign objects to enter the camera.**

This could result in electrical shock or fire.

If liquids or foreign objects come into contact with the camera interior, immediately turn the camera power off and remove the battery.

If the battery charger becomes wet, unplug it from the outlet and consult your camera distributor or a Canon Customer Support Help Desk.

- **Use only the recommended battery.**
- **Do not place the battery near or in direct flame.**
- **Unplug the power cord periodically, and using a dry cloth, wipe away any dust and dirt that has collected on the plug, the exterior of the power outlet, and the surrounding area.**
- **Do not handle the power cord with wet hands.**
- **Do not use the equipment in a manner that exceeds the rated capacity of the electrical outlet or wiring accessories. Do not use if the power cord or plug are damaged, or not fully plugged into the outlet.**
- **Do not allow dirt or metal objects (such as pins or keys) to contact the terminals or plug.**

The battery may explode or leak, resulting in electrical shock or fire. This could cause injury and damage the surroundings. In the event that a battery leaks and the battery acid contacts eyes, mouth, skin or clothing, immediately flush with water.

- **Turn the camera off in places where camera use is prohibited.**

The electromagnetic waves emitted by the camera may interfere with the operation of electronic instruments and other devices. Exercise adequate caution when using the camera in places where use of electronic devices is restricted, such as inside airplanes and medical facilities.

- **Do not play the supplied CD-ROM(s) in any CD player that does not support data CD-ROMs.**

It is possible to suffer hearing loss from listening with headphones to the loud sounds of a CD-ROM played on a music CD player. Additionally, playing the CD-ROM(s) in an audio CD player (music player) could damage the speakers.



Caution

Denotes the possibility of injury.

- **Be careful not to bang the camera or subject it to strong impacts or shocks when hanging it by the strap.**
- **Be careful not to bump or push strongly on the lens.**

This could lead to injury or damage the camera.

- **When using the flash, be careful not to cover it with your fingers or clothing.**

This could result in burns or damage to the flash.

- **Avoid using, placing or storing the product in the following places:**
 - Places subject to strong sunlight
 - Places subject to temperatures above 40 °C (104 °F)
 - Humid or dusty areas

These could cause leakage, overheating or an explosion of the battery, resulting in electrical shock, fire, burns or other injuries.

- **The slideshow transition effects may cause discomfort when viewed for prolonged periods.**

Caution

Denotes the possibility of damage to the equipment.

- **Do not aim the camera at bright light sources (such as the sun on a clear day).**

Doing so may damage the image sensor.

- **When using the camera on a beach or at a windy location, be careful not to allow dust or sand to enter the camera.**

This may cause the product to malfunction.

- **In regular use, small amounts of smoke may be emitted from the flash.**

This is due to the high intensity of the flash burning dust and foreign materials stuck to the front of the unit. Please use a cotton swab to remove dirt, dust or other foreign matter from the flash to prevent heat build-up and damage to the unit.

Safety Precautions

- **Remove and store the battery when you are not using the camera.**

If the battery is left inside the camera, damage caused by leakage may occur.

- **Before you discard the battery, cover the terminals with tape or other insulators.**

Contacting other metal materials may lead to fire or explosions.

- **Unplug the battery charger from the power outlet after charging is complete, or when you are not using it.**
- **Do not place anything, such as cloth on top of the battery charger while it is charging.**

Leaving the unit plugged in for a long period of time may cause it to overheat and distort, resulting in fire.

- **Do not place the battery near pets.**

Pets biting the battery could cause leakage, overheating or explosion, resulting in fire or damage.

- **Do not sit down with the camera in your pocket.**

Doing so may cause malfunctions or damage the screen.

- **When putting the camera in your bag, ensure that hard objects do not come into contact with the screen.**

- **Do not attach any hard objects to the camera.**

Doing so may cause malfunctions or damage the screen.



Getting Started

This chapter explains preparations before shooting, how to shoot in **AUTO** mode, and then how to view and erase the images you take. The latter part of this chapter explains how to shoot and view images in Easy mode, how to shoot and view movies, and how to transfer images to a computer.

Attaching the Strap/Holding the Camera

- Attach the included strap and wrap it around your wrist to avoid dropping the camera during use.
- Keep your arms tight against your body while holding the camera firmly by the sides when shooting. Be sure that your fingers do not block the flash.

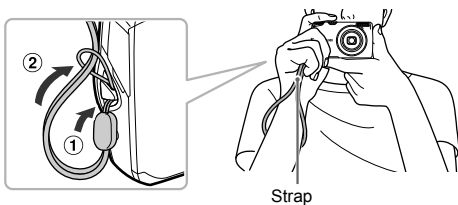

Charging the Battery

Use the included charger to charge the battery. Be sure to charge the battery as it is not charged at the time of purchase.

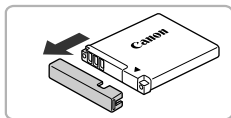

1 Remove the cover.

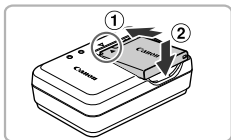

2 Insert the battery.

- Align the ▲ marks on the battery and charger, then insert the battery by sliding it in (1) and down (2).

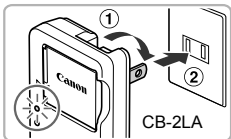

3 Charge the battery.

- For **CB-2LA**: Flip out the plug (1) and plug the charger into a power outlet (2).
- For **CB-2LAE**: Plug the power cord into the charger, then plug the other end into a power outlet.
- ▶ The charge lamp lights orange and charging starts.
- ▶ The charge lamp will light green when charging has finished. Charging takes approx. 1 hour and 30 minutes.

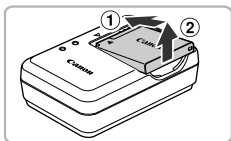
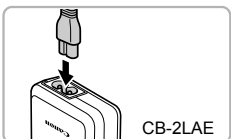

4 Remove the battery.

- Unplug the battery charger from the power outlet, then remove the battery by sliding it in (1) and up (2).



To protect the battery and prolong its life, do not charge it for longer than 24 hours continuously.



Number of Possible Shots

	A3300 IS	A3200 IS	A2200
Number of Shots	Approx. 230	Approx. 250	Approx. 280
Playback Time	Approx. 5 hours	Approx. 6 hours	Approx. 6 hours

- The number of shots that can be taken is based on the Camera & Imaging Products Association (CIPA) measurement standard.
- Under some shooting conditions, the number of shots that can be taken may be less than mentioned above.

Battery Charge Indicator

An icon or message will appear on the screen indicating the battery's charge state.

Display	Summary
	Sufficient charge.
	Slightly depleted, but sufficient.
 (Blinking red)	Nearly depleted. Charge the battery.
"Change the battery pack."	Depleted. Recharge the battery.



Using the battery and charger effectively

- Charge the battery on the day, or the day before, it will be used. Charged batteries continue to discharge naturally even if they are not used.

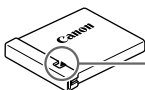

Attach the cover to a charged battery so that the ▲ mark is visible.

- How to store the battery for long periods:
Deplete and remove the battery from the camera. Attach the terminal cover and store the battery. Storing a battery for long periods of time (about a year) without depleting it may shorten its life span or affect its performance.
- The battery charger can also be used when abroad.
The charger can be used in regions that have 100 – 240 V (50/60 Hz) AC power. If the plug does not fit the outlet, use a commercially available plug adapter. Do not use electrical transformers for foreign travel as they will cause damage.
- The battery may develop a bulge.
This is a normal characteristic of the battery and does not indicate a problem. However, if the battery bulges to the point where it will no longer fit into the camera, please contact a Canon Customer Support Help Desk.
- If the battery is quickly depleted even after charging, it has reached the end of its life span. Purchase a new battery.

Compatible Memory Cards (Sold Separately)

The cards below can be used without restrictions on their capacities.

- SD memory cards*
- SDHC memory cards*
- SDXC memory cards* 
- MultiMediaCards
- MMC*plus* memory cards
- HC MMC*plus* memory cards

* This memory card complies with the SD standards. Some cards may not operate properly depending on the brand of card used.



Depending on your computer's OS version, SDXC memory cards may not be recognized even when using a commercially available card reader. Check to make sure that your OS supports SDXC memory cards beforehand.

Inserting the Battery and Memory Card

Insert the included battery and a memory card (sold separately).

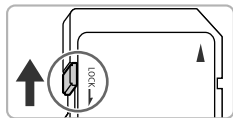

1 Check the card's write-protect tab.

- If the memory card has a write-protect tab, you will not be able to record images if the tab is in the locked position. Slide the tab up until you hear a click.

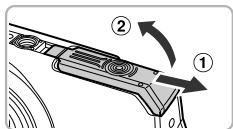

2 Open the cover.

- Slide the cover (①) and open it (②).

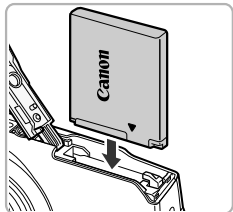

3 Insert the battery.

- Insert the battery as shown until it locks into place with a click.
- Be sure to insert the battery in the correct direction or it will not properly lock into place.

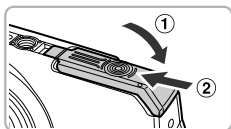
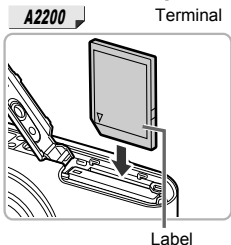
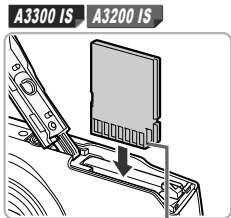

4 Insert the memory card.

- Insert the memory card as shown until it locks into place with a click.
- Be sure the memory card is oriented correctly. Inserting the memory card in the wrong direction could damage the camera.

5 Close the cover.

- Close the cover (①), and press downward as you slide it until it clicks into place (②).

? What if [Memory card locked] appears on the screen?

SD, SDHC and SDXC memory cards have a write-protect tab. If this tab is in the locked position, [Memory card locked] will appear on the screen and you will not be able to take or erase images.

Removing the Battery and Memory Card

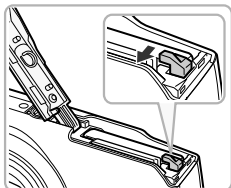

Remove the battery.

- Open the cover and press the battery lock in the direction of the arrow.
- ▶ The battery will pop up.

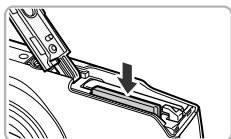

Remove the memory card.

- Push the memory card in until you hear a click, then slowly release it.
- ▶ The memory card will pop up.

Number of Shots per Memory Card

Memory Card	4 GB	16 GB
Number of Shots	Approx. 935 A3300 IS	Approx. 3830 A3300 IS
	Approx. 1058 A3200 IS	Approx. 4334 A3200 IS
	Approx. 1058 A2200	Approx. 4334 A2200

- Values are based on the default settings.
- The number of shots that can be taken will vary depending on camera settings, the subject and the memory card used.



Can you check the number of shots that can be taken?

You can check the number of shots that can be taken when the camera is in a Shooting mode (p. 24).

Number of shots that can be taken



Setting the Date and Time

The Date/Time settings screen will appear the first time the camera is turned on. Since the dates and times recorded into your images are based on these settings, be sure to set them.

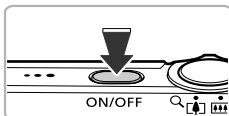

1 Turn on the camera.

- Press the power button.
- ▶ The Date/Time screen will appear.



2 Set the date and time.

- Press the ◀▶ buttons to choose an option.
- Press the ▲▼ buttons to set a value.



3 Complete the setting.



- Press the  button.
- ▶ Once the date and time have been set, the Date/Time screen will close.
- Pressing the power button will turn off the camera.

? Reappearing Date/Time screen

Set the correct date and time. If you have not set the date and time, the Date/Time screen will appear each time you turn on the camera.



Daylight saving time settings

If you choose  in Step 2 and press the ▲▼ buttons to choose , you will set the time to daylight saving (1 hour ahead).

Changing the Date and Time

You can change the current date and time settings.

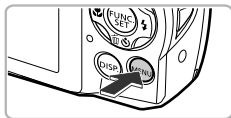

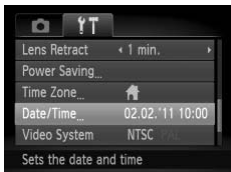

1 Display the menu.

- Press the **MENU** button.



2 Choose [Date/Time] from the tab.

- Move the zoom lever to choose the  tab.
- Press the  buttons to choose [Date/Time], then press the .



3 Change the date and time.

- Follow Steps 2 and 3 on p. 19 to adjust the setting.
- Press the **MENU** button to close the menu.



Date/Time battery

- The camera has a built-in date/time battery (backup battery) that allows the date/time settings to be retained for about three weeks after the battery pack has been removed.
- By inserting a charged battery or connecting an AC adapter kit (sold separately, p. 39) the date/time battery can be charged in about 4 hours even if the camera is not turned on.
- If the date/time battery is depleted, the Date/Time screen will appear when you turn the camera on. Follow the steps on p. 19 to set the date and time.

Setting the Display Language

You can change the language that displays on the screen.



1 Enter Playback mode.

- Press the button.



2 Display the settings screen.

- Press and hold the button, then immediately press the **MENU** button.



3 Set the display language.

- Press the buttons to choose a language, then press the button.
- ▶ Once the display language has been set, the settings screen will close.



What if the clock appears when the button is pressed?

The clock will appear if too much time passes between pressing the button and the **MENU** button in Step 2. If the clock appears, press the button to remove the clock and repeat Step 2.



You can also change the display language by pressing the **MENU** button to choose [Language] from the tab.

Formatting Memory Cards

Before you use a new memory card or one that has been formatted in other devices, you should format the card with this camera.

Formatting (initializing) a memory card erases all data on the memory card. As you cannot retrieve the erased data, exercise adequate caution before formatting the memory card.

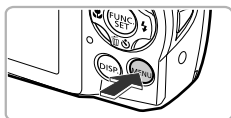

1 Display the menu.

- Press the MENU button.



2 Choose [Format].

- Move the zoom lever to choose the tab.
- Press the buttons to choose [Format], then press the .

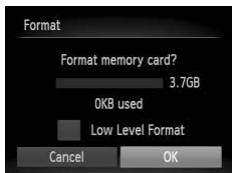

3 Choose [OK].

- Press the buttons to choose [OK], then press the .

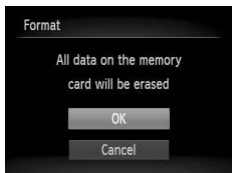

4 Format the memory card.

- Press the buttons to choose [OK], then press the .
- ▶ The memory card will be formatted.

5 Complete formatting.

- ▶ When formatting ends, [Memory card formatting complete] will appear on the screen.
- Press the  button.



Formatting or erasing data on a memory card merely changes the file management information on the card and does not ensure its contents are completely erased. Be careful when transferring or disposing of a memory card. When disposing of a memory card, take precautions such as physically destroying the card to prevent personal information leaks.



- The total capacity of the memory card displayed in the formatting screen may be less than indicated on the memory card.
- Perform a low-level format (p. 151) of the memory card when the camera does not operate properly, the recording/reading speed of a memory card has dropped, when continuous shooting speed slows down, or when movie recording stops suddenly.

Pressing the Shutter Button

To take images that are in focus, be sure to first press the shutter button lightly (halfway) to focus, then press fully to shoot.

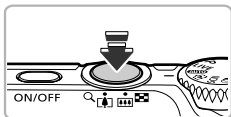

1 Press halfway (Press lightly to focus).

- Press lightly until the camera beeps twice and AF frames appear where the camera focused.

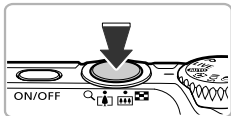

2 Press fully (Press fully to shoot).

- ▶ The camera plays the shutter sound and takes the shot.



If you shoot without pressing the shutter button halfway, the image may not be in focus.

Taking Pictures (Smart Auto)

Since the camera can determine the subject and shooting conditions, you can let it automatically select the best settings for the scene and just shoot. The camera can also detect and focus on faces, setting the color and brightness to optimal levels.

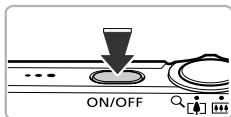

1 Turn on the camera.

- Press the power button.
- ▶ The start-up screen will appear.

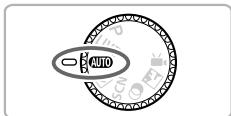

2 Enter **AUTO** mode.

- Set the mode dial to **AUTO**.
- When you point the camera toward the subject, the camera will make a slight noise as it determines the scene.
- ▶ The icon for the determined scene will appear in the upper right of the screen.
- ▶ The camera will focus on detected subjects and display frames on them.

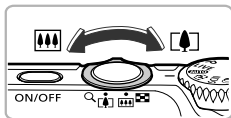

3 Compose the shot.

- Moving the zoom lever toward (telephoto) will zoom in on your subject, making it appear larger. Moving the lever toward (wide angle) will zoom out from your subject, making it appear smaller. (The zoom bar showing the zoom position appears on the screen.)

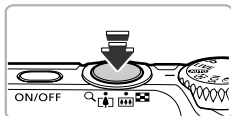

4 Focus.

- Press the shutter button halfway to focus.



AF Frame

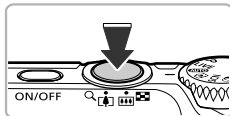

5 Shoot.

- Press the shutter button fully to shoot.
- ▶ The camera will play the shutter sound and shoot. The flash will automatically fire in low light conditions.
- ▶ The image will appear on the screen for approximately two seconds.
- You can take a second picture even while an image is displayed by pressing the shutter button again.



What if...

- **What if the color and brightness of the images do not turn out as expected?**

The scene icon (p. 172) that appears on the screen may not match the actual scene. If this happens, try shooting in **P** mode (p. 83).

- **What if white and gray frames appear when you point the camera toward a subject?**

A white frame appears on the face or subject that the camera detected as the main subject, while gray frames appear on other detected faces. The frames will follow the subjects within a certain range (p. 92).

If the subject moves, however, the gray frames will disappear, leaving only the white frame.

- **What if a frame does not appear on the subject you want to shoot?**

The subject may not be detected, and frames may appear on the background. If this happens, try shooting in **P** mode (p. 83).



- **What if a blue frame appears when you press the shutter button halfway?**

A blue frame appears when a moving subject is detected; the focus and exposure will continuously adjust (Servo AF).



- **What if a flashing  appears?**

Attach the camera to a tripod so that the camera does not move and blur the image.

- **What if the camera does not play any sounds?**

Pressing the **DISP.** button while turning on the camera power will turn off all sounds. To turn the sounds on, press the **MENU** button to choose [Mute] from the  tab, then press the  buttons to choose [Off].

- **What if the image comes out dark even if the flash fired when shooting?**

The subject is too far away for the flash to reach. The effective flash range is approximately 30 cm – 4.0 m (12 in. – 13 ft.) at maximum wide angle () , and approximately 50 cm – 2.0 m (1.6 – 6.6 ft) at maximum telephoto () .

- **What if the camera beeps once when the shutter button is pressed halfway?**

Your subject may be too close. Move the following distances away from your subject and shoot:

When at maximum wide angle () : Approximately 3.0 cm (1.2 in.) or more.

When at maximum telephoto () : Approximately 90 cm (3.0 ft.) or more

  , and approximately 80 cm (2.6 ft.) or more  .

- **What if the lamp lights when the shutter button is pressed halfway?**

To reduce red-eye and to assist in focusing, the lamp may light when shooting in dark areas.

- **What if the  icon blinks when you try to shoot?**

The flash is charging. You can shoot when recharging ends.





What if an icon appears in the upper right of the screen?

The icon for the determined scene will appear in the upper right of the screen. For details on the icons that appear, see “Scene Icons” (p. 172).



Choosing the subject to focus on (Tracking AF)

After pressing the  button and displaying  , point the camera so that  is on the subject you want to focus on. Press and hold the shutter button halfway to display a blue frame where focus and exposure will be maintained (Servo AF). Press the shutter button fully to shoot.

Viewing Images

You can view the images you have taken on the screen.







1 Enter Playback mode.

- Press the  button.
- ▶ The last image you took will appear.



2 Choose an image.

- Pressing the  button will cycle through the images from newest to oldest.
- Pressing the  button will cycle through the images from oldest to newest.
- The images change more quickly if you keep the   buttons pressed, but they will appear coarse.
- The lens will retract after approximately 1 minute elapses.
- Pressing the  button again while the lens is retracted will turn off the power.



Switching to Shooting mode

Pressing the shutter button halfway, or turning the mode dial in Playback mode switches the camera to Shooting mode.

Erasing Images

You can choose and erase images one at a time. Please note that erased images cannot be recovered. Exercise adequate caution before erasing an image.



1 Enter Playback mode.

- Press the  button.
- ▶ The last image you took will appear.







2 Choose an image to erase.

- Press the  buttons to display an image to erase.



3 Erase the image.

- Press the  button.
- ▶ [Erase?] appears on the screen.
- Press the  buttons to choose [Erase], then press the  button.
- ▶ The displayed image will be erased.
- To exit instead of erasing, press the  buttons to choose [Cancel], then press the  button.





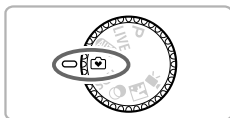

Shooting or Viewing Images in Easy Mode

In Easy mode, operational instructions are displayed on the screen, and the camera is set so that only the buttons and the zoom lever explained on this page are functional. This prevents incorrect operation of the camera, allowing even beginners to take worry-free pictures.





Shooting



- Set the mode dial to .
- Follow Steps 3 – 5 on pp. 24 – 25 to shoot (no sound will play).
- Press the  button to turn off the flash.  will appear on the screen. Pressing the  button again turns on the flash and  appears on the screen. The flash will automatically fire in low light conditions.

Viewing



- Press the  button, then press the  buttons to switch images.
- Press the  button, then press the  button, and all the shots you have taken will display for about 3 seconds each. Press the  button again to stop the slideshow.
- To erase images, follow the steps on p. 28.

Shooting Movies

The camera can automatically select all settings so that you can shoot movies just by pressing the shutter button.

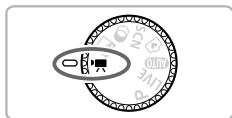



1 Enter mode.

- Set the mode dial to .

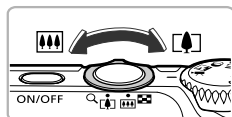
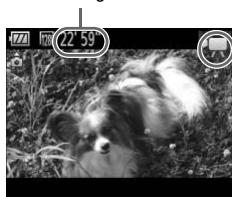
Remaining Time



2 Compose the shot.

- Moving the zoom lever toward  will zoom in on your subject, making it appear larger. Moving the lever toward  will zoom out from your subject, making it appear smaller.

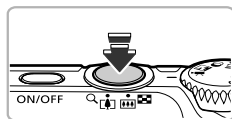

3 Focus.

- Press the shutter button halfway to focus.
- ▶ When the camera focuses, it will beep twice.

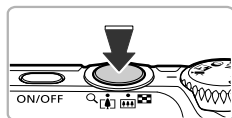

4 Shoot.

- Press the shutter button fully.

Elapsed Time



A3300 IS A3200 IS



Microphone

A2200



Microphone

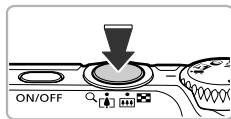

5 Stop shooting.

- Press the shutter button fully again.
- ▶ The camera will beep once and stop shooting the movie.
- ▶ The movie will record to the memory card.
- ▶ Shooting will automatically stop when the memory card fills.



Zooming while shooting

Pressing the zoom lever while shooting will zoom in on or out from the subject. However, movies shot at zoom factors that appear in blue will be coarse. Operation sounds will be recorded.

Shooting Time

Memory Card	4 GB	16 GB
Shooting Time	Approx. 22 min. 5 sec.	Approx. 1 hr. 30 min. 30 sec.

- Shooting times are based on default settings.
- Maximum clip length is approx. 10 minutes.
- Recording may stop even if the maximum clip length has not been reached on some memory cards. SD Speed Class 4 or higher memory cards are recommended.

Viewing Movies

You can view the movies you have shot on the screen.



1 Enter Playback mode.

- Press the button.
- ▶ The last image you took will appear.
- ▶ appears on movies.



2 Choose a movie.

- Press the buttons to choose a movie, then press the button.
- The movie control panel will appear.





3 Play the movie.

- Press the ◀▶ buttons to choose ▶ (Play), then press the button.
- ▶ The movie will play.
- If you press the button, you can pause or resume playback.
- Press the ▲▼ buttons to adjust the volume.
- ▶ After the movie finishes, appears.

? How can I play back movies on a computer?

Install the included software (p. 35).

- When watching a movie on a computer, frames may drop, it may not play smoothly, and the audio may stop suddenly depending on the computer's capabilities.
- If you use the supplied software to copy the movie back onto the memory card, you can play back the movie smoothly with the camera. For enhanced playback you can also connect the camera to a TV.

Transferring Images to a Computer for Viewing

You can use the included software to transfer images you have shot with the camera to a computer for viewing. If you are already using software included with another Canon-brand compact digital camera, install the software from the included CD-ROM, overwriting your current installation.

System Requirements

Windows

OS	Windows 7 Windows Vista Service Pack 1 and 2 Windows XP Service Pack 3
Computer model	The above OS should be pre-installed on computers with built-in USB ports.
CPU	Pentium 1.3 GHz or higher (still images), Core2 Duo 1.66 GHz or higher (movies)
RAM	Windows 7 (64 bit): 2 GB or more Windows 7 (32 bit), Windows Vista (64 bit, 32 bit): 1 GB or more Windows XP: 512 MB or more (still images), 1 GB or more (movies)
Interface	USB
Free Hard Disk Space	ZoomBrowser EX: 200 MB or more CameraWindow: 150 MB or more* Movie Uploader for YouTube: 30 MB or more PhotoStitch: 40 MB or more
Display	1,024 x 768 pixels or higher

* For Windows XP, Microsoft .NET Framework 3.0 or later (max. 500 MB) must be installed. Installation may take some time depending on your computer's capabilities.

Macintosh

OS	Mac OS X (v10.5 – v10.6)
Computer model	The above OS should be pre-installed on computers with built-in USB ports.
CPU	Intel Processor (still images), Core Duo 1.66 GHz or higher (movies)
RAM	Mac OS X v10.6: 1 GB or more Mac OS X v10.5: 512 MB or more (still images), 1 GB or more (movies)
Interface	USB
Free Hard Disk Space	ImageBrowser: 250 MB or more CameraWindow: 150 MB or more Movie Uploader for YouTube: 30 MB or more PhotoStitch: 50 MB or more
Display	1,024 x 768 pixels or higher

Preparations

Windows Vista and Mac OS X (v10.5) are used for these explanations.

1 Install the Software.

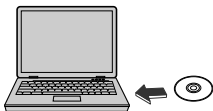

Windows

① Place the CD in the computer's CD-ROM drive.

- Place the supplied CD-ROM (DIGITAL CAMERA Solution Disk) (p. 2) into the computer's CD-ROM drive.

② Begin installation.

- Click [Easy Installation] and follow the on-screen instructions to proceed with the installation.
- If the [User Account Control] window appears, follow the on-screen instructions to proceed.

③ When the installation finishes, click [Restart] or [Finish].

④ Remove the CD-ROM.

- Remove the CD-ROM when your desktop screen appears.



Macintosh

① Place the CD in the computer's CD-ROM drive.

- Place the supplied CD-ROM (DIGITAL CAMERA Solution Disk) (p. 2) into the computer's CD-ROM drive.

② Begin installation.

- Double-click the  on the CD.
- Click [Install], and follow the on-screen instructions to proceed with the installation.



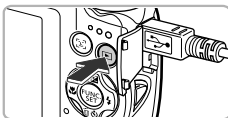
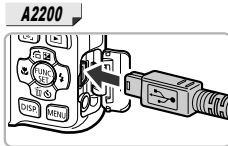
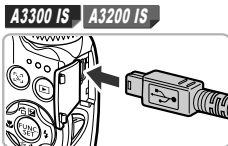

2 Connect the camera to the computer.

- Turn off the camera.
- Open the cover and insert the included interface cable's smaller plug (p. 2) firmly into the camera terminal in the direction shown.
- Insert the interface cable's larger plug into the computer. For connection details, refer to the user guide provided with the computer.

3 Turn on the camera.

- Press the  button to turn on the camera.

4 Open CameraWindow.



Windows

- Click [Downloads Images From Canon Camera using Canon CameraWindow].
- ▶ CameraWindow will appear.
- If CameraWindow does not appear, click the [Start] menu and choose [All Programs], followed by [Canon Utilities], [CameraWindow] and [CameraWindow].





Macintosh

- ▶ CameraWindow will appear when you establish a connection between the camera and computer.
- If CameraWindow does not appear, click the CameraWindow icon on the Dock (the bar which appears at the bottom of the desktop).



For Windows 7, use the following steps to display CameraWindow.

- ① Click  on the task bar.
- ② In the screen that appears, click the  link to modify the program.
- ③ Choose [Downloads Images From Canon Camera using Canon CameraWindow] and click [OK].
- ④ Double click .

Transfer and View Images



- Click [Import Images from Camera], and then click [Import Untransferred Images].
- ▶ All images not previously transferred will transfer to the computer. Transferred images will be sorted by date and saved in separate folders in the Pictures folder.
- Close CameraWindow when image transfer is complete.
- Turn off the camera and unplug the cable.
- For details on how to view images using a computer, refer to the *Software Guide*.



You can transfer images even without using the image transfer function in the included software by simply connecting your camera to a computer. There are, however, the following limitations.

- It may take a few minutes from when you connect the camera to the computer until you can transfer images.
- Images shot in the vertical orientation may be transferred in the horizontal orientation.
- Protection settings for images may be lost when transferred to a computer.
- There may be problems transferring images or image information correctly depending on the version of the operating system in use, the file size, or the software in use.
- Some functions in the included software may not be available, such as editing movies, and transferring images to the camera.

Accessories

Supplied with Camera

A3300 IS **A3200 IS**

AV Cable AVC-DC400*

A2200

AV Cable AVC-DC300*

Interface Cable
IFC-400PCU*



Wrist Strap
WS-800



Battery Pack NB-8L with
Terminal Cover*



Battery Charger
CB-2LA/CB-2LAE*



DIGITAL CAMERA
Solution Disk

*Also available for purchase separately.



Memory Card



USB card reader



Windows/Macintosh

Canon-Brand PictBridge Compliant Printers



TV

Separately Sold Accessories

The following camera accessories are sold separately. Some accessories are not sold in some regions, or may no longer be available.

Power Supplies

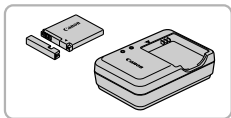

Battery Charger CB-2LA/2LAE

- A charger for charging Battery Pack NB-8L.

Battery Pack NB-8L

- Rechargeable lithium-ion battery.

AC Adapter Kit ACK-DC60

- This kit lets you power the camera using household power. Recommended for powering the camera for an extended period of time or when connecting to a computer or printer. Cannot be used to charge the camera battery.

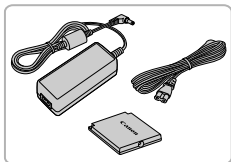

Using Accessories Abroad

The battery charger and the AC adapter kit can be used in regions that have 100 – 240 V (50/60 Hz) AC power.

If the plug does not fit the outlet, use a commercially available plug adapter. Do not use electrical transformers for foreign travel as they will cause damage.

CAUTION

RISK OF EXPLOSION IF BATTERY IS REPLACED BY AN INCORRECT TYPE.
DISPOSE OF USED BATTERIES ACCORDING TO LOCAL REGULATION.

Flash



High-Power Flash HF-DC1

- This externally mounted flash can be used to capture photographic subjects that are too distant for the built-in flash to illuminate.

Printers



SELPHY series



PIXMA series

Canon-Brand PictBridge Compliant Printers

- By connecting your camera to a Canon-brand PictBridge compliant printer, you can print your images without having to use a computer.

For more information, visit your nearest Canon retailer.

Use of genuine Canon accessories is recommended.

This product is designed to achieve excellent performance when used with genuine Canon accessories. Canon shall not be liable for any damage to this product and/or accidents such as fire, etc., caused by the malfunction of non-genuine Canon accessories (e.g., a leakage and/or explosion of a battery pack). Please note that this warranty does not apply to repairs arising out of the malfunction of non-genuine Canon accessories, although you may request such repairs on a chargeable basis.

2

Learning More

This chapter explains the parts of the camera and what appears on the screen, as well as the basic operating instructions.



Components Guide

A3300 IS **A3200 IS**

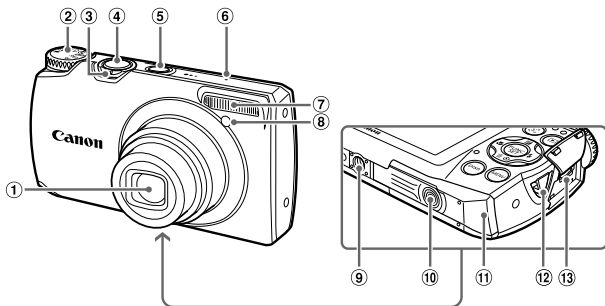

- ① Lens
- ② Mode Dial
- ③ Zoom Lever
Shooting: [T] (Telephoto) / [W] (Wide Angle) (pp. 24, 30, 57)
Playback: Q (Magnify) / [Index] (pp. 114, 118)
- ④ Shutter Button (p. 23)
- ⑤ Power Button (p. 19)
- ⑥ Microphone (p. 31)
- ⑦ Flash (pp. 56, 85)
- ⑧ Lamp (pp. 60, 61, 62, 80, 157)
- ⑨ Tripod Socket
- ⑩ DC Coupler Terminal Cover (p. 164)
- ⑪ Memory Card / Battery Cover (p. 16)
- ⑫ Strap Mount (p. 13)
- ⑬ A/V OUT (Audio/Video Output) / DIGITAL Terminal (pp. 36, 120, 138)

A2200

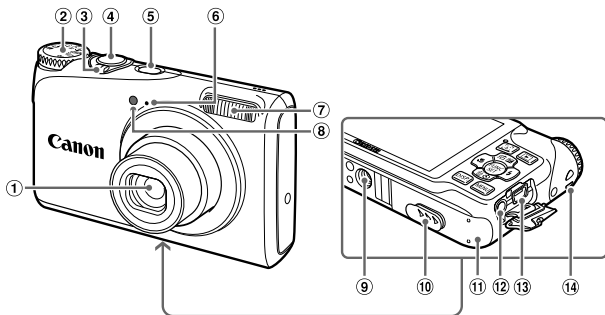

- ① Lens
- ② Mode Dial
- ③ Zoom Lever
Shooting: (Telephoto) / (Wide Angle) (pp. 24, 30, 57)
Playback: Q (Magnify) / (Index) (pp. 114, 118)
- ④ Shutter Button (p. 23)
- ⑤ Power Button (p. 19)
- ⑥ Microphone (p. 31)
- ⑦ Flash (pp. 56, 85)
- ⑧ Lamp (pp. 60, 61, 62, 80, 157)
- ⑨ Tripod Socket
- ⑩ DC Coupler Terminal Cover (p. 164)
- ⑪ Memory Card / Battery Cover (p. 16)
- ⑫ A/V OUT (Audio/Video Output) Terminal (p. 120)
- ⑬ DIGITAL Terminal (pp. 36, 138)
- ⑭ Strap Mount (p. 13)

Mode Dial

Use the mode dial to change the Shooting mode.

P Mode

Choose settings yourself to take various types of pictures (p. 84).

Live View Control Mode

The brightness and color can be easily set to your preferences for shooting (p. 71).

Auto Mode

You can leave it to the camera to select settings for fully automatic shooting (p. 24).

Easy Mode

You can shoot just by pressing the shutter button (p. 29).

Special Scene Mode

You can shoot with the optimum settings for the scene (p. 68).

Movie Mode

For shooting movies (pp. 30, 105).
You can use the largest possible portion of the screen to shoot movies (p. 108).

Discreet Mode

You can shoot with the flash disabled and all camera sounds muted (p. 72).

Creative Filters Mode

You can add various effects to images when shooting (p. 72).



If you turn the mode dial while in Playback mode, the camera will switch to Shooting mode.

A3300 IS A3200 IS

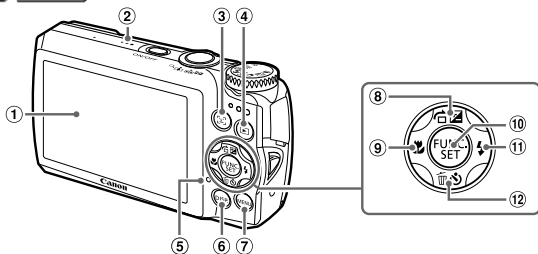

A2200

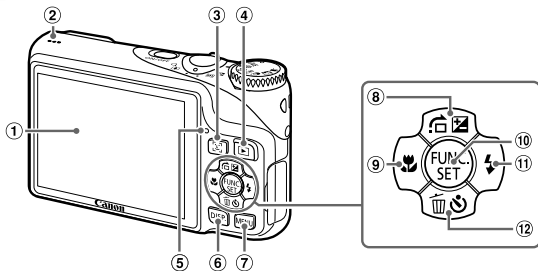

- ① Screen (LCD Monitor)
(pp. 46, 171, 173)
- ② Speaker
- ③ (Face Selector) Button (p. 98)
- ④ (Playback) Button (pp. 27, 113)
- ⑤ Indicator (p. 47)
- ⑥ **DISP.** (Display) Button (p. 46)
- ⑦ **MENU** Button (p. 49)
- ⑧ (Exposure Compensation) (p. 85) /
 (Jump) (p. 115) / Button
- ⑨ (Macro) (p. 91) / Button
- ⑩ **FUNC./SET** Button (p. 48)
- ⑪ (Flash) (pp. 85, 101) / Button
- ⑫ (Self-Timer) (pp. 60, 61, 62) /
 (Single Image Erase) (p. 28) /
 Button

Screen Display

Switching the Display

You can change the screen display using the **DISP.** button. Refer to p. 171 for details on information that appears on the screen.

Shooting



Information Display



No Information Display



Playback



No Information Display



Simple Information Display



Detailed Information Display



Focus Check Display (p. 117)



You can also switch the display by pressing the **DISP.** button while the image displays right after shooting. However, Simple Information Display is not available. You can change the display that appears first by pressing the **MENU** button, then choosing [Review info] from the tab (p. 158).

Screen Display in Dark Shooting Conditions

The display automatically brightens when shooting in dark conditions, allowing you to check the composition (Night Display function). However, the brightness of the image on the screen, and the brightness of the actual image recorded may be different. Screen noise may appear and the movement of the subject may appear somewhat jagged on the screen. This has no effect on the recorded image.

Overexposure Warning during Playback

In Detailed Information Display (p. 46), overexposed areas of the image flash on the screen.

Histogram during Playback

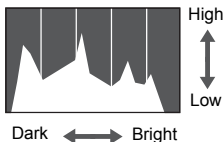

- The graph that appears in Detailed Information Display (p. 173) is called the histogram. The histogram shows the distribution of brightness in an image horizontally, and the amount of brightness vertically. When the graph approaches the right side, the image is bright, but when it approaches the left side, the image is dark, and in this way you can judge the exposure.

Indicator

The indicator on the back of the camera (p. 45) will light or blink depending on the camera's status.

Colors	Status	Operation Status
Green	Lights	When connected to a computer (p. 36), display off (p. 155)
	Blinks	During camera start-up, recording/reading/transmitting image data, when shooting long exposures (p. 81)



When the indicator blinks green, do not turn off the power, open the memory card slot/battery cover, shake or jolt the camera. These actions may corrupt the image data or cause the camera or memory card to malfunction.

FUNC. Menu – Basic Operations

You can set commonly used shooting functions using the FUNC. menu. The menu items and options differ depending on the Shooting mode (pp. 176 – 183).



1 Display the FUNC. menu.

- Press the  button.



2 Choose a menu item.

- Press the ▲▼ buttons to choose a menu item.
- ▶ The available options for the menu item appear in the lower part of the screen.
- Choosing some menu items changes the screen to display further menu options.

3 Choose an option.

- Press the ◀▶ buttons to choose an option.
- You can also choose settings by pressing the **DISP.** button on options that display .



4 Complete the setting.

- Press the  button.
- ▶ The shooting screen will reappear and the setting you chose will display on the screen.

MENU – Basic Operations

Various functions can be set from the menus. The menu items are organized under tabs, such as for shooting (📷) and playback (▶). The options differ depending on the Shooting mode and the Playback mode (pp. 184 – 193).



1 Display the menu.

- Press the MENU button.



2 Choose a tab.

- Move the zoom lever or press the ◀▶ buttons to choose a tab.

3 Choose an item.

- Press the ▲▼ buttons to choose an item.
- Some items require you to press the FUNC. SET or ▶ button to display a submenu in which you change the setting.



4 Choose an option.

- Press the ◀▶ buttons to choose an option.

5 Complete the setting.

- Press the MENU button to restore the normal screen.



Changing the Sound Settings

You can silence or adjust the volume of camera sounds.

Muting Sounds

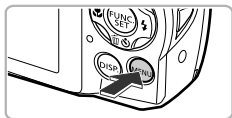

1 Display the menu.

- Press the **MENU** button.



2 Choose [Mute].

- Move the zoom lever to choose the **YT** tab.
- Press the **▲▼** buttons to choose [Mute], then press the **◀▶** buttons to choose [On].
- Press the **MENU** button to restore the normal screen.

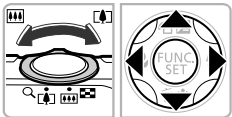

- You cannot change the sound settings in .
- You can also mute camera sounds by holding down the **DISP.** button and turning on the power.
- If you mute camera sounds, the sound will also be muted when playing back movies (p. 32). If you press the **▲** button while playing back a movie, the sound will play back, and you can adjust the volume with the **▲▼** buttons.

Adjusting the Volume

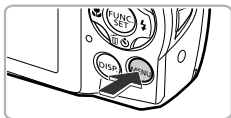

1 Display the menu.

- Press the **MENU** button.



2 Choose [Volume].

- Move the zoom lever to choose the **↑↑** tab.
- Press the **▲▼** buttons to choose [Volume], then press the **FUNC. SET** button.



3 Change the volume.

- Press the **▲▼** buttons to choose an item, then press the **◀▶** buttons to adjust the volume.
- Press the **MENU** button twice to restore the normal screen.

Adjusting the Screen Brightness

You can adjust the brightness of the screen.

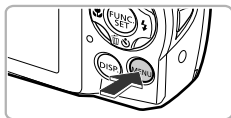

1 Display the menu.

- Press the **MENU** button.



2 Choose [LCD Brightness].

- Move the zoom lever to choose the **↑↑** tab.
- Press the **▲▼** buttons to choose [LCD Brightness].

3 Adjust the brightness.

- Press the **◀▶** buttons to adjust the brightness.
- Press the **MENU** button twice to restore the normal screen.



Returning the Camera to Default Settings

When you have mistakenly changed a setting, you can reset the camera to the default settings.



1 Display the menu.

- Press the MENU button.



2 Choose [Reset All].

- Move the zoom lever to choose the tab.
- Press the buttons to choose [Reset All], then press the button.



3 Reset the settings.

- Press the buttons to choose [OK], then press the button.
- ▶ The camera will reset to the default settings.

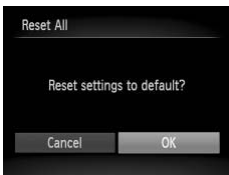

Are there functions that cannot be reset?

- The [Date/Time] (p. 20), [Language] (p. 21), [Video System] (p. 120), [Time Zone] (p. 155), and the image registered in [Start-up Image] (p. 152) in the tab.
- The recorded custom white balance data (p. 86).
- The shooting mode chosen in **SCN** (p. 68) or (p. 72).
- The Movie mode (p. 30).

Power Saving Function (Auto Power Down)

To save battery power, the screen turns off, and the camera shuts down automatically when it is not operated for a certain time.

Power Saving during Shooting

The screen will turn off approximately 1 minute after you stop operating the camera. After about 2 more minutes, the lens will retract and the power will turn off. When the screen has turned off but the lens has not yet retracted, pressing the shutter button halfway (p. 23) turns on the screen and shooting can continue.

Power Saving during Playback

The power will turn off approximately 5 minutes after you stop operating the camera.





- You can turn off the power saving function (p. 154).
- You can adjust the time before the screen turns off (p. 155).

Clock Functions

You can check the current time.



- Press and hold the  button.
- ▶ The current time appears.
- If you hold the camera vertically while using the clock function, it will switch to vertical display. Press the ◀▶ buttons to change the display color.
- Press the  button again to cancel the clock display.



When the camera power is off, press and hold the  button, then press the power button to display the clock.

3

Shooting with Commonly Used Functions

This chapter explains how to use common functions, such as the self-timer, and how to turn off the flash.

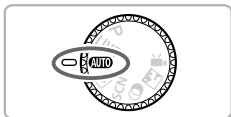

- This chapter assumes that the camera is set to **AUTO** mode. When shooting in another mode, check which functions are available in that mode (pp. 176 – 183).

Turning the Flash Off

You can shoot with the flash turned off.



1 Press the ► button.



2 Choose ⚡.

- Press the ◀▶ buttons to choose ⚡, then press the FUNC. SET button.
- ▶ Once set, ⚡ will appear on the screen.
- To turn the flash back on, follow the steps above to choose ⚡^A.



? What if a flashing ⚡ appears?

When you press the shutter button halfway in low light conditions where camera shake is likely, a flashing ⚡ will appear on the screen. Attach the camera to a tripod to prevent it from moving.

Zooming in More Closely on Subjects (Digital Zoom)

You can use the digital zoom to zoom up to to approximately 20x maximum **A3300 IS** **A3200 IS**, and approximately 16x maximum **A2200** and capture subjects that are too far away for the optical zoom to enlarge.

However, depending on the recording pixel setting (p. 63) and zoom factor, the images may appear coarse (the zoom factor will appear in blue).

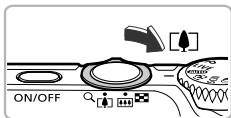

1 Move the zoom lever toward [20x].

- Hold the lever until zooming stops.
- ▶ Zooming stops at the largest possible zoom factor without image deterioration. The zoom factor will appear on the screen when you release the zoom lever.

Zoom Factor



2 Move it toward [20x] again.

- ▶ The digital zoom will zoom in even further on the subject.



Turning off the digital zoom

To turn off the digital zoom, press the **MENU** button to choose [Digital Zoom] from the **☑** tab, then choose [Off].



The focal lengths when using the optical zoom and digital zoom together are as follows (all focal lengths are 35mm film equivalent):

Approximately 28 – 560 mm (28 – 140 mm when using the optical zoom alone) **A3300 IS** **A3200 IS**

Approximately 28 – 448 mm (28 – 112 mm when using the optical zoom alone) **A2200**

Digital Tele-Converter

The focal length of the lens can be set as follows:

Approximately 1.6x or approximately 2.0x **A3300 IS**

Approximately 1.7x or approximately 2.1x **A3200 IS**, **A2200**

This enables a faster shutter speed and less chance of camera shake than the zoom (including digital zoom) used by itself at the same zoom factor.

However, a recording pixel setting (p. 63) of **L** or **M1** will cause images to appear coarse (the zoom factor will appear in blue).

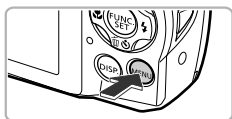

1 Display the menu.

- Press the **MENU** button.



2 Choose [Digital Zoom].

- Move the zoom lever to choose the tab.
- Press the **▲▼** buttons to choose [Digital Zoom].

3 Choose the setting.

- Press the **◀▶** buttons to choose a magnification.
- Press the **MENU** button to complete the setting and restore the shooting screen.
- ▶ The view will be enlarged and the zoom factor will appear on the screen.
- To return to standard digital zoom, choose [Digital Zoom] and the [Standard] option.

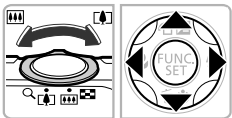

- The focal lengths are as follows (35mm film equivalent):
 Approximately 44.8 – 224 mm when using [1.6x], and approximately 56.0 – 280 when using [2.0x] **A3300 IS**
 Approximately 47.6 – 238 mm when using [1.7x], and approximately 58.8 – 294 mm when using [2.1x] **A3200 IS**
 Approximately 47.6 – 190 mm when using [1.7x], and approximately 58.8 – 235 mm when using [2.1x] **A2200**
- The digital tele-converter cannot be used together with the digital zoom.
- The shutter speeds may be the same when at maximum telephoto () and when zoomed in on the subject using Step 2 on p. 57.

Inserting the Date and Time

You can insert the shooting date and time in the lower right corner of an image. Once inserted, however, they cannot be deleted. Be sure to check beforehand that the date and time are correctly set (p. 19).



1 Display the menu.

- Press the **MENU** button.



2 Choose [Date Stamp].

- Move the zoom lever to choose the tab.
- Press the buttons to choose [Date Stamp].

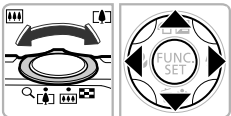

3 Choose the setting.

- Press the buttons to choose [Date] or [Date & Time].
- Press the **MENU** button to complete the setting and restore the shooting screen.
- ▶ Once set, [DATE] will appear on the screen.



4 Shoot.

- ▶ The shooting date or time will be recorded in the image's lower right corner.
- To restore to the original setting, choose [Off] in Step 3.

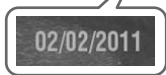



You can insert and print the shooting date in images which do not have an embedded date and time as follows. However, if you do this for images with an embedded date and time, the date and time may be printed twice.

- Use the DPOF print settings (p. 145) to print.
- Use the included software to print.
Refer to the *Software Guide* for details.
- Print using printer functions (p. 140).

Using the Self-Timer

The self-timer can be used to shoot a group photo that includes the photographer. The camera will shoot approximately 10 seconds after the shutter button is pressed.



1 Press the ▼ button.



2 Choose 10.

- Press the ▲▼ buttons to choose 10, then press the FUNC. SET button.
- ▶ Once set, 10 will appear on the screen.



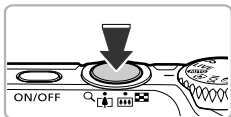

3 Shoot.

- Press the shutter button halfway to focus on the subject, then press it fully.
- ▶ When the self-timer starts, the lamp blinks and the self-timer sound plays.
- ▶ Two seconds before the shutter releases, the lamp and sound speed up (the lamp remains lit when the flash will fire).
- To cancel shooting with the self-timer after the countdown has started, press the ▼ button.
- To restore the original setting, choose  in Step 2.





You can change the delay and number of shots (p. 62).

Using the Self-Timer to Prevent Camera Shake

The camera will shoot approximately 2 seconds after the shutter button is pressed, preventing any camera shake that occurs when pressing the shutter button.



Choose .

- Follow Step 2 on p. 60 to choose .
- ▶ Once set,  will appear on the screen.
- Follow Step 3 above to shoot.

Customizing the Self-Timer

You can set the delay (0 – 30 seconds) and the number of shots (1 – 10 shots).

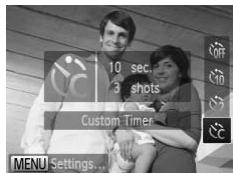







1 Choose .

- Follow Step 2 on p. 60 to choose , then press the **MENU** button immediately.



2 Choose the settings.

- Press the   buttons to choose [Delay] or [Shots].
- Press the   buttons to choose a value, then press the  button.
- ▶ Once set,  will appear on the screen.
- Follow Step 3 on p. 61 to shoot.

? What if the number of shots is set to two or more shots?

- Exposure and white balance settings are set with the first shot.
- If the flash fires or you set a high number of shots, the shooting interval may take longer than usual.
- If the memory card fills, shooting stops automatically.



When you set the delay for more than 2 seconds, the lamp and self-timer sound speed up 2 seconds before the shutter releases (the lamp remains lit when the flash will fire).

Changing the Recording Pixel Setting (Image Size)

You can choose from 5 recording pixel settings.



1 Choose the recording pixel setting.

- After pressing the **FUNC SET** button, press the **▲▼** buttons to choose **L**.

2 Choose an option.

- Press the **◀▶** buttons to choose an option, then press the **FUNC SET** button.
- ▶ The setting will appear on the screen.
- To restore the original setting, choose **L** in Steps 1 – 2.



If you choose **W**, you cannot use the digital zoom (p. 57) or digital teleconverter (p. 58).

Changing the Compression Ratio (Image Quality)

You can choose from the following 2 compression ratios (image quality): **▲** (Fine), **■** (Normal).

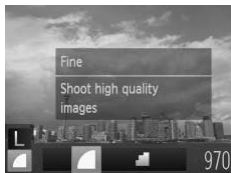

1 Choose the compression ratio setting.

- After pressing the **FUNC SET** button, press the **▲▼** buttons to choose **▲**.











2 Choose an option.

- Press the **◀▶** buttons to choose an option, then press the **FUNC SET** button.
- ▶ The setting will appear on the screen.
- To restore the original setting, choose **■** in Steps 1 – 2.













Approximate Values for Recording Pixels and Compression Ratio

A3300 IS

Recording Pixels	Compression Ratio	Single Image Data Size (Approx. KB)	Number of Shots per Memory Card (Approx. shots)	
			4 GB	16 GB
L (Large) 16M/4608x3456		4093	935	3830
		1956	1915	7844
M1 (Medium 1) 8M/3264x2448		2060	1828	7487
		980	3771	15443
M2 (Medium 2) 2M/1600x1200		558	6352	26010
		278	12069	49420
S (Small) 0.3M/640x480		150	20116	82367
		84	30174	123550
W (Widescreen) 4608x2592		3069	1243	5094
		1467	2567	10514

* The values in the table are measured according to Canon standards and may change depending on the subject, memory card and camera settings.

A3200 IS **A2200**

Recording Pixels	Compression Ratio	Single Image Data Size (Approx. KB)	Number of Shots per Memory Card (Approx. shots)	
			4 GB	16 GB
L (Large) 14M/4320x3240		3597	1058	4334
		1719	2194	8985
M1 (Medium 1) 7M/3072x2304		1897	1978	8101
		902	4022	16473
M2 (Medium 2) 2M/1600x1200		558	6352	26010
		278	12069	49420
S (Small) 0.3M/640x480		150	20116	82367
		84	30174	123550
W (Widescreen) 4320x2432		2700	1403	5746
		1291	2873	11766

* The values in the table are measured according to Canon standards and may change depending on the subject, memory card and camera settings.

Approximate Values for Paper Size

A2 (16.5 x 23.4 in.)	M1	L
A3 – A5 (11.7 x 16.5 – 5.8 x 8.3 in.)		
5 x 7 in. Postcard size 3.5 x 5 in.		

- **S** For sending images as e-mail attachments.
- **W** For displaying on wide-screen HD TVs with an aspect ratio of 16:9.



4

Adding Effects and Shooting in Various Conditions

This chapter explains how to add effects and how to shoot in various conditions.

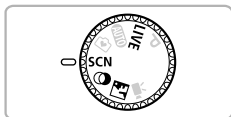

Shooting in Various Conditions

The camera will select the necessary settings for the conditions in which you wish to shoot when you choose the matching mode.

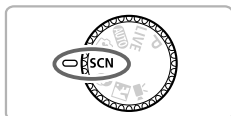

1 Enter SCN mode.

- Set the mode dial to **SCN**.

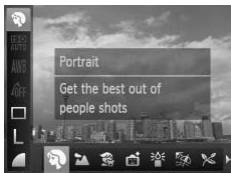

2 Choose a Shooting mode.

- After pressing the **FUNC. SET** button, press the **▲▼** buttons to choose the following:
 - A3300 IS** **A3200 IS**
 - A2200**
- Press the **◀▶** buttons to choose a Shooting mode, then press the **FUNC. SET** button.



3 Shoot.



(A) Take shots with reduced blur (Blur Reduction) **A2200**

- Lets you shoot with reduced camera shake and subject blur.



(P) Take portraits (Portrait)

- Produces a soft effect when photographing people.



Take landscapes (Landscape)

- Lets you shoot majestic landscapes with a real sense of depth.



Take shots of kids and pets (Kids&Pets)

- Lets you capture subjects that move around, such as children and pets, without missing photo opportunities.
- Move approximately 1 m (3.3 ft.) or more away from your subject and shoot.



Take shots in low light conditions (Low Light)

- Lets you take shots in dark places with reduced camera shake and subject blur.



Take shots of people at the beach (Beach)

- Lets you take shots of brightly lit people on sandy beaches where the reflected sunlight is strong.



Take shots of foliage (Foliage)

- Lets you shoot trees and leaves, such as new growth, autumn leaves or blossoms, in vivid colors.



Take shots of people in snow (Snow)

- Lets you take bright, natural-colored shots of people against snowy backgrounds.



Take shots of fireworks (Fireworks)



- Lets you take shots of fireworks in vivid colors.



In  mode, attach the camera to a tripod to prevent the camera from moving and blurring the image. Additionally, you should set [IS Mode] to [Off] when shooting with a tripod (p. 160). **A3300 IS** **A3200 IS**



- The recording pixel setting is fixed in the following modes:

: **M** (2304 x 1728 pixels) **A3300 IS**
M (2144 x 1608 pixels) **A3200 IS** **A2200**
: **M** (2144 x 1608 pixels) **A2200**

- In  mode, images may appear coarse because the ISO speed (p. 87) is increased to match the shooting conditions.

Easily Changing the Brightness and Color When Shooting (Live View Control)

You can easily change the brightness, color and tone to match your preferences when shooting.



1 Set the camera to LIVE mode.

- Set the mode dial to **LIVE**.

2 Press the button.

- ▶ The setting screen will appear.

3 Adjust the setting.

- Press the ▲▼ buttons to choose an option, then press the ◀▶ buttons while watching the screen to adjust the setting.
- Press the  button.

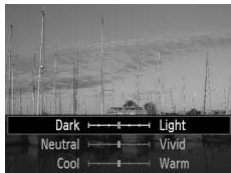



4 Shoot.

Brightness	You can adjust the brightness of the image. The more to the right, the brighter the image gets, the more to the left, the darker the image gets.
Color	You can change the color of the image. The more to the right, the more vivid the image gets, the more to the left, the more neutral the image gets.
Tone	You can adjust the tone of the image. The more to the right, the stronger the warm red tones get, the more to the left, the the stronger the cool blue tones get.

Shooting in Discreet Mode

You can shoot with camera sounds muted, and the flash and lamp deactivated. Use this mode in areas where camera sounds, lights and flash are not permitted.



- 1 **Set the camera to  mode.**
 - Set the mode dial to .
- 2 **Shoot.**





When the camera is set to  mode, sounds will remain muted even when in Playback mode. Operation sounds will be muted, and audio will not play back when viewing movies.



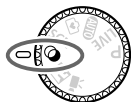

Adding Effects and Shooting (Creative Filters)

You can add various effects to images when shooting.

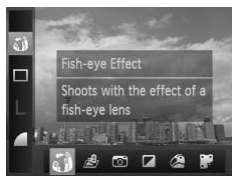





- 1 **Set the camera to  mode.**
 - Set the mode dial to .



- 2 **Choose a Shooting mode.**
 - After pressing the  button, press the  buttons to choose .
 - Press the  buttons to choose a Shooting mode, then press the .
- 3 **Shoot.**



Since you may not achieve the expected results with images shot in , , ,  and , try taking some test shots first.



Shoot images with vivid colors (Super Vivid)

- Lets you take shots with vivid, intense colors.



Take posterized shots (Poster Effect)

- Lets you take shots that look like an old poster or illustration.

Shoot with the Effects of a Fish-Eye Lens (Fish-eye Effect)

Lets you shoot with the distorting effect of a fish-eye lens.

1 Choose .

- Follow Steps 1 – 2 on p. 72 to choose .

2 Choose an effect level.

- Press the **DISP.** button.
- ▶ [Effect Level] will appear on the screen.
- Press the **◀▶** buttons to choose an effect level, then press the **DISP.** button.
- ▶ You can check the effect on the screen.



3 Shoot.

Take Shots That Look Like a Miniature Model (Miniature Effect)

Blurs chosen portions in the top and bottom of an image to produce the effect of a miniature model.

1 Choose .

- Follow Steps 1 – 2 on p. 72 to choose .
- ▶ A white frame (the area that will not be blurred) appears on the screen.



2 Choose the area to keep in focus.

- Press the DISP. button.
- Move the zoom lever to change the frame size, and press the ▲▼ buttons to change the frame position, then press the DISP. button.

3 Shoot.



- If you press the  button in Step 2, the horizontal/vertical orientation of the frame will switch, and you can press the ◀▶ buttons to change the frame position when it is displayed vertically.
- Holding the camera vertically will change the orientation of the frame.

Shoot with the Effects of a Toy Camera (Toy Camera Effect)

This effect darkens and blurs the corners of the image, and changes the overall color so that it looks like an image shot with a toy camera.

1 Choose .

- Follow Steps 1 – 2 on p. 72 to choose .

2 Choose a color tone.

- Press the **DISP.** button.
- ▶ [Color Tone] will appear on the screen.
- Press the **◀▶** buttons to choose a color tone, then press the **DISP.** button.
- ▶ You can check the color tone on the screen.



3 Shoot.

Standard	Images will look like they were shot with a toy camera.
Warm	Gives images a warmer tone than [Standard].
Cool	Gives images a cooler tone than [Standard].

Shooting in Monochrome

You can shoot images in black and white, sepia or blue and white.

1 Choose .

- Follow Steps 1 – 2 on p. 72 to choose .



2 Choose a color tone.

- Press the **DISP.** button.
- ▶ [Color Tone] will appear on the screen.
- Press the ◀▶ buttons to choose a color tone, then press the **DISP.** button.
- ▶ You can check the color tone on the screen.

3 Shoot.

B/W	Lets you shoot black and white images.
Sepia	Lets you shoot sepia toned images.
Blue	Lets you shoot blue and white images.



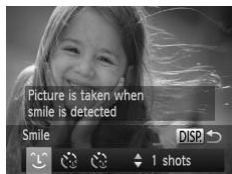

Detecting a Face and Shooting (Smart Shutter)

Detecting a Smile and Shooting

The camera will shoot, even without pressing the shutter button, when it detects a smile.





1 Choose .

- Follow Steps 1 – 2 on p. 68 to choose , then press the **DISP.** button.
- Press the   buttons to choose , then press the **DISP.** button.

▶ The camera will enter shooting stand-by, and [Smile Detection on] will appear on the screen.





2 Point the camera at a person.

- Each time the camera detects a smile it will shoot after the lamp lights.
- Press the  button to pause smile detection. Press the  button again to resume smile detection.

What if a smile is not detected?

Smiles are easier to detect if the subject faces the camera, and opens their mouth enough to show some teeth when smiling.

Changing the number of shots

After choosing  in Step 1, press the   buttons.





- You should switch to another mode when you finish shooting, or the camera will continue taking shots each time the camera detects a smile.
- You can also shoot by pressing the shutter button.

Using the Wink Self-Timer

Point the camera at a person and press the shutter button fully. The camera will shoot approximately two seconds after it detects a wink.



1 Choose .

- Follow Steps 1 – 2 on p. 68 to choose , then press the **DISP.** button.
- Press the **◀▶** buttons to choose , then press the **DISP.** button.

2 Compose the shot and press the shutter button halfway.

- Confirm that a green frame appears around the face of the person who will wink.

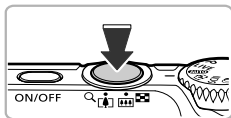

3 Press the shutter button fully.

- ▶ The camera will enter shooting stand-by, and [Wink to take picture] will appear on the screen.
- ▶ The lamp will blink and the self-timer sound will play.

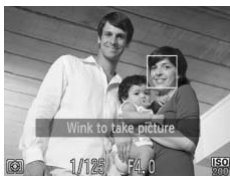

4 Face the camera and wink.

- ▶ The shutter will release approximately 2 seconds after a wink is detected from the person inside the frame.
- To cancel the countdown, press the **▼** button.

What if a wink is not detected?

- Wink a bit slowly.
- A wink may not be detected if eyes are covered by hair or a hat, or when wearing glasses.

Changing the number of shots

After choosing  in Step 1, press the ▲▼ buttons.







- Shutting both eyes will also be detected as a wink.
- If a wink is not detected, the shutter will release approximately 15 seconds later.
- If there are no people in the shot when the shutter button is pressed fully, the camera will shoot after a person enters the shot and winks.

Using the Face Self-Timer

The shutter will release approximately two seconds after the camera detects a new face (p. 92). You can use this when the photographer wants to be in the image, such as a group photo.



1 Choose .

- Follow Steps 1 – 2 on p. 68 to choose , then press the **DISP.** button.
- Press the   buttons to choose , then press the **DISP.** button.

2 Compose the shot and press the shutter button halfway.

- Make sure a green frame appears on the face focused on and white frames appear on other faces.

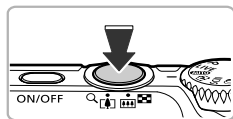

3 Press the shutter button fully.

- ▶ The camera will enter shooting stand-by, and [Look straight at camera to start count down] will appear on the screen.
- ▶ The lamp will blink and the self-timer sound will play.



4 Join the subjects and look at the camera.

- ▶ When the camera detects a new face, the lamp and self-timer sound will speed up (the lamp remains lit when the flash will fire), and two seconds later the shutter will release.
- To cancel shooting with the timer after countdown has started, press the  button.



Changing the number of shots

After choosing  in Step 1, press the   buttons.



Even if your face is not detected after joining the subjects, the shutter will release approximately 15 seconds later.

Shooting Long Exposures

You can set the shutter speed to a range between 1 and 15 seconds to shoot long exposures. However, you should attach the camera to a tripod to prevent the camera from moving and blurring the image.

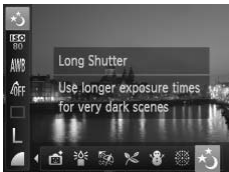



1 Choose .

- Follow Steps 1 – 2 on p. 68 to choose .



2 Choose the shutter speed.

- Press the  button.
- Press the  buttons to choose the shutter speed, then press the  button.

3 Confirm the exposure.

- When you press the shutter button halfway, the exposure for the chosen shutter speed will appear on the screen.



- The brightness of the image may differ from the brightness of the screen in Step 3 when the shutter button was pressed halfway.
- When shutter speeds of 1.3 seconds or slower are used, images are processed to eliminate noise after being taken. A certain amount of processing time may be needed before you can take the next shot.
- You should set the [IS Mode] to [Off] when shooting with a tripod (p. 160).

A3300 IS **A3200 IS**



- The indicator blinks green while the camera prepares to shoot.
- If the flash fires, the image may be overexposed. If this happens, set the flash to  and shoot.



5

Choosing Settings Yourself

In this chapter you will learn how to use the various functions in **P** mode to progressively advance your shooting skills.

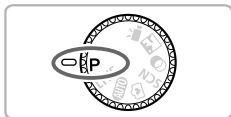

- This chapter assumes that you have set the mode dial to **P** mode.
- **P** stands for Program AE.
- Before attempting to shoot using a function explained in this chapter in modes other than **P** mode, check if the function is available in those modes (pp. 176 – 191).

Shooting in Program AE

You can choose the settings for various functions to suit your preferences. AE stands for Auto Exposure. The focusing range is as follows:

At maximum wide angle (☰): approximately 5.0 cm (2.0 in.) – infinity.

At maximum telephoto (☒): approximately 90 cm (3.0 ft.) – infinity

A3300 IS, **A3200 IS**, and approximately 80 cm (2.6 ft.) – infinity **A2200**.



1 Enter **P** mode.

- Set the mode dial to **P**.

2 Adjust the settings according to your purposes (pp. 85 – 103).

3 Shoot.

? What if the shutter speed and aperture value appear in orange?

If a correct exposure cannot be obtained when pressing the shutter button halfway, the shutter speed and aperture value appear in orange. Try the following settings to obtain the correct exposure.

- Turn on the flash (p. 85)
- Choose a higher ISO speed (p. 87)

Adjusting the Brightness (Exposure Compensation)

You can adjust the standard exposure set by the camera in 1/3-stop increments in the range of -2 to +2.





1 Enter Exposure Compensation mode.

- Press the ▲ button.

2 Adjust the brightness.



- While watching the screen, press the ◀▶ buttons to adjust the brightness, then press the  button.
- ▶ The exposure compensation amount will appear on the screen.

Turning the Flash On

You can make the flash fire every time you shoot. The effective flash range is approximately 30 cm – 4.0 m (12 in. – 13 ft.) at maximum wide angle () , and approximately 50 cm – 2.0 m (1.6 – 6.6 ft.) at maximum telephoto () .



Choose .

- After pressing the ▶ button, press the ◀▶ buttons to choose , then press the  button.
- ▶ Once set,  will appear on the screen.

Adjusting the White Balance

The white balance (WB) function sets the optimal white balance for natural looking colors to match the shooting conditions.









1 Choose the white balance function.

- After pressing the  button, press the  buttons to choose **AWB**.

2 Choose an option.

- Press the  buttons to choose an option, then press the  button.
- ▶ The setting will appear on the screen.

 Auto	Automatically sets the optimal white balance for the shooting conditions.
 Day Light	For shooting outdoors, in fine weather conditions.
 Cloudy	For shooting in cloudy, shady or twilight conditions.
 Tungsten	For shooting under tungsten and bulb-type (3-wavelength) fluorescent lighting.
 Fluorescent	For shooting under warm-white fluorescent, cool-white fluorescent and warm-white-type (3-wavelength) fluorescent lighting.
 Fluorescent H	For shooting under daylight fluorescent and daylight-type (3-wavelength) fluorescent lighting.
 Custom	For manually setting a custom white balance.

Custom White Balance

You can adjust the white balance to match the light source at the shooting location. Make sure that you set the white balance under the light source of the actual scene you will shoot.



- In Step 2 above, choose .
- Make sure the entire screen is filled with a plain, white colored subject, then press the **DISP** button.
- ▶ The tint on the screen will change when white balance data is set.



If you change camera settings after recording white balance data, the tone may not turn out properly.

Changing the ISO Speed

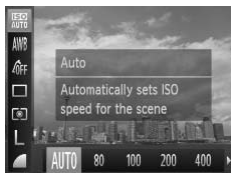









1 Choose the ISO speed.

- After pressing the  button, press the  buttons to choose .

2 Choose an option.

- Press the  buttons to choose an option, then press the  button.
- ▶ The setting will appear on the screen.

	Automatically adjusts the ISO speed to the Shooting mode and shooting conditions.	
  	Low	For shooting outdoors, in fine weather conditions.
 		For shooting in cloudy, or twilight conditions.
	High	For shooting nightscapes, or in dark interiors.



Changing the ISO speed

- Lowering the ISO speed results in sharper images, but there may be an increased chance of image blurring in certain shooting conditions.
- Raising the ISO speed results in a faster shutter speed, reducing image blurring and letting the flash reach greater distances to the subject. The images, however, will appear coarse.





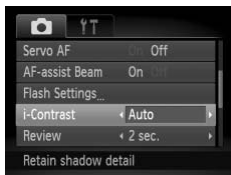

When the camera is set to , you can press the shutter button halfway to display the automatically set ISO speed.

Correcting the Brightness and Shooting (i-Contrast)

The camera can detect areas in the scene, such as faces or backgrounds, that are too bright or dark and automatically adjust them to the optimum brightness when shooting. Also, when the overall image is lacking in contrast, the camera will automatically correct the image for a sharper impression when shooting.



Choose [i-Contrast].

- Press the **MENU** button to choose [i-Contrast] from the  tab, then press the   buttons to choose [Auto].
- ▶ Once set,  will appear on the screen.



- Under some conditions, the image may appear coarse or may not be corrected properly.
- You can correct recorded images (p. 134).

Continuous Shooting



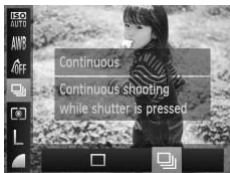

You can shoot continuously at a maximum speed of approximately 0.8 images/second **A3300 IS**, and 0.9 images/second **A3200 IS** **A2200** while the shutter button is pressed fully and held.



1 Choose a Drive mode.

- After pressing the  button, press the  buttons to choose .



2 Choose an option.

- Press the  buttons to choose , then press the .
- Once set,  will appear on the screen.

3 Shoot.

- ▶ As long as you hold the shutter button down, the camera will shoot successive images.



- Cannot be used with the self-timer (pp. 60, 61, 62).
- In  (p. 68) **A2200** and  (p. 69) modes, continuous shooting speed increases.
- For continuous shooting, the focus and exposure are locked when the shutter button is pressed halfway.
- Depending on the shooting conditions and the camera settings, the camera may stop shooting momentarily, or the shooting speed may slow down.
- As the number of images increases, the shooting speed may slow down.
- If the flash fires, the shooting speed may slow down.

Changing the Tone of an Image (My Colors)

You can change the tone of an image, for example to sepia or black and white, when shooting.

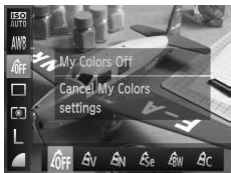

1 Choose My Colors.

- After pressing the **FUNC SET** button, press the **▲▼** buttons to choose **OFF**.

2 Choose an option.

- Press the **◀▶** buttons to choose an option, then press the **FUNC SET** button.
- ▶ The setting will appear on the screen.

OFF My Colors Off	—
V Vivid	Emphasizes the contrast and color saturation for a vivid impression.
N Neutral	Tones down the contrast and color saturation for neutral hues.
Se Sepia	Changes the image to sepia tones.
BW B/W	Changes the image to black and white.
C Custom Color	You can adjust contrast, sharpness, and color saturation etc. to your preference.



The white balance cannot be set in **Se** and **BW** (p. 86).

Custom Color

The contrast, sharpness, and color saturation in an image can be chosen and set at 5 different levels.



- Follow Step 2 above to choose **C**, then press the **DISP.** button.
- Press the **▲▼** buttons to choose an option, then press the **◀▶** buttons to choose a value.
- The more to the right, the stronger/deeper the effect gets, the more to the left, the weaker/lighter the effect gets.
- Press the **DISP.** button to complete the setting.

Shooting Close-ups (Macro)

You can shoot an object at a close distance or even shoot extreme close-ups of it. The focusing range is approximately 3.0 – 50 cm (1.2 in. – 1.6 ft.) from the end of the lens at maximum wide angle (📷).



Choose 🌷.

- After pressing the ◀ button, press the ▶ buttons to choose 🌷, then press the FUNC SET button.
- ▶ Once set, 🌷 will appear on the screen.



The edges of the image may darken if the flash fires.



How can I take better close-ups?

Try attaching the camera to a tripod and shooting in 🔄 to prevent the camera from moving and blurring the image (p. 61).



🌷 will turn gray in the area that displays in the yellow bar underneath the zoom bar, and the camera will not focus.

Shooting Far Away Subjects (Infinity)

When it is difficult to focus because your shot contains subjects that are both near and far, you can change the focusing range to focus more reliably on far away subjects (approx. 3.0 m (9.8 ft.) or more from the camera) only.



Choose 🏔️.

- After pressing the ◀ button, press the ▶ buttons to choose 🏔️, then press the FUNC SET button.
- ▶ Once set, 🏔️ will appear on the screen.

Changing the AF Frame Mode

You can change the AF (Auto Focus) frame mode to match the scene you want to shoot.



Choose [AF Frame].

- Press the **MENU** button to choose [AF Frame] from the  tab, then press the **◀▶** buttons to choose an option.

Face AiAF

- Detects people's faces and sets the focus, exposure (evaluative metering only) and white balance (AWB only).
- When the camera is pointed at subjects, a white frame appears on the face the camera judges to be the main subject, and gray frames (max. 2) will appear on other faces.
- A frame will follow a moving subject within a certain range.
- When the shutter button is pressed halfway, up to 9 green frames will appear on faces that the camera focuses on.



- If a face is not detected, or only gray frames (no white frame) appear, up to 9 green frames will appear on the areas the camera focuses on when the shutter button is pressed halfway.
- If a face is not detected when Servo AF (p. 97) is set to [On], the AF frame will appear in the center of the screen when you press the shutter button halfway.
- Examples of faces that cannot be detected:
 - Subjects that are far away or extremely close
 - Subjects that are dark or light
 - Faces turned to the side or at an angle, or faces with a portion hidden
- The camera may mistakenly identify non-human subjects as a face.
- If the camera cannot focus when you press the shutter button halfway, the AF frame will not appear.

Tracking AF

You can choose the subject you want to focus on and shoot (p. 94).

Center

The AF frame is locked to the center. This is effective for focusing on a specific point.



You can reduce the AF frame size

- Press the **MENU** button to choose [AF Frame Size] from the  tab, then choose [Small].
- The AF frame is set to [Normal] when using the digital zoom (p. 57) or digital tele-converter (p. 58).



If the camera cannot focus when you press the shutter button halfway, the AF frame will turn yellow and  will appear.

Changing the Composition with the Focus Lock

While you keep the shutter button pressed halfway, the focus and exposure are locked. You can now recompose and shoot. This is called Focus Lock.



1 Focus.

- Center the subject you want in focus, and press the shutter button halfway.
- Confirm that the AF frame on the subject is green.



2 Recompose.

- Keep the shutter button pressed halfway and move the camera to recompose the scene.

3 Shoot.

- Press the shutter button fully.

Choosing the Subject to Focus On (Tracking AF)

You can choose the subject you want to focus on and shoot.



1 Choose [Tracking AF].

- Press the **MENU** button to choose [AF Frame] from the tab, then press the buttons to choose [Tracking AF].
- ▶ will appear in the center of the screen.



2 Choose the subject to focus on.

- Point the camera so that is on the subject you want to focus on and press the button.



- ▶ The camera will beep and will appear when a subject is detected. The camera will continue to track the subject within a certain range even if the subject moves.
- ▶ If the camera does not detect the subject, will appear on the screen.
- To cancel tracking, press the button again.

3 Shoot.

- Press the shutter button halfway. will change into a blue which will follow the subject while the camera continues to adjust the focus and exposure (Servo AF) (p. 97).
- Press the shutter button fully to shoot.
- ▶ Even after shooting completes, will appear, and the camera will continue to track the subject.



- The camera will detect a subject even if you press the shutter button half way without pressing the ◀ button. When shooting completes, □ will appear in the center of the screen.
- Servo AF (p. 97) is fixed to [On].
- The camera may not be able to track the subject if the subject is too small, moves too quickly or if the contrast between the subject and the background is too low.
- Not available in 🍷 or ▲.

Magnifying the Focal Point

If you press the shutter button halfway, the AF frame will magnify and you can check the focus.



1 Choose [AF-Point Zoom].

- Press the MENU button to choose [AF-Point Zoom] from the 📷 tab, then press the ◀▶ buttons to choose [On].



2 Check the focus.

- Press the shutter button halfway.
 - ▶ In [Face AiAF] (p. 92), the face detected as the main subject will appear magnified.
 - ▶ In [Center] (p. 93), the contents of the center AF frame will appear magnified.



What if the display does not magnify?

The display will not appear magnified in [Face AiAF] if a face cannot be detected or is too big in relation to the screen. In [Center], it will not appear magnified if the camera cannot focus.



The magnified display will not appear when using the digital zoom (p. 57), digital tele-converter (p. 58), Tracking AF (p. 93), Servo AF (p. 97) or when using a TV as a display (p. 103).

Shooting with the AF Lock

The focus can be locked. After locking the focus, the focal distance will not change even when you release your finger from the shutter button.

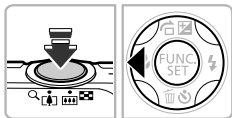

1 Lock the focus.

- Keep the shutter button pressed halfway and press the ◀ button.
- ▶ The focus locks and AFL appears on the screen.
- If you release your finger from the shutter button and press the ◀ button again, AFL will disappear and the focus will unlock.

2 Compose the scene and shoot.

Shooting with Servo AF

While the shutter button is pressed halfway, the focus and exposure will continue to adjust, allowing you to take pictures of moving subjects without missing a shot.

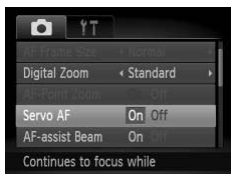

1 Choose [Servo AF].

- Press the **MENU** button to choose [Servo AF] from the tab, then press the buttons to choose [On].

2 Focus.

- The focus and exposure will be maintained where the blue AF frame appears while you press the shutter button halfway.







- The camera may not be able to focus in some conditions.
- In low light conditions, AF frames may not turn blue even after pressing the shutter button halfway. In this case, you can set the focus and exposure with the AF frame setting.
- If a correct exposure cannot be obtained, the shutter speed and aperture value appear in orange. Release your finger from the shutter button, then press it again halfway.
- You cannot shoot with the AF lock in this mode.
- The [AF-Point Zoom] option in the tab is not available in Servo AF mode.
- Not available when using the self-timer (pp. 60, 61, 62).

Choosing the Person to Focus On (Face Select)

You can choose a specific person's face to focus on and then shoot.





1 Enter Face Select mode.

- Point the camera toward the face of the subject and press the  button.
- ▶ After [Face Select : On] appears, a face frame  will appear around the face detected as the main subject.
- Even if the subject moves, the face frame  will follow the subject within a certain range.
- If a face is not detected,  will not appear.





2 Choose the face to focus on.

- If you press the  button, the face frame  will move to another face detected by the camera.
- When the frame has made a full circuit of all detected faces, [Face Select : Off] will appear, and the AF frame mode screen will reappear.



3 Shoot.

- Press the shutter button halfway. When the camera focuses,  will change into .
- Press the shutter button fully to shoot.

Changing the Metering Method

You can change the metering method (brightness measuring function) to match the shooting conditions.



1 Choose the metering method.

- After pressing the **FUNC/SET** button, press the **▲▼** buttons to choose **[]**.

2 Choose an option.

- Press the **◀▶** buttons to choose an option, then press the **FUNC/SET** button.
- ▶ The setting will appear on the screen.

[] Evaluative	For standard shooting conditions, including back lit shots. Automatically adjusts the exposure to match the shooting conditions.
[] Center Weighted Avg.	Averages the light metered from the entire frame, but gives greater weight to the center.
[] Spot	Only meters within the [] (Spot AE Point frame) that appears at the center of the screen.

Shooting with the AE Lock

You can lock the exposure and shoot, or set the focus and exposure separately to shoot. AE stands for “Auto Exposure”.

1 Choose (p. 56).



2 Lock the exposure.

- Point the camera toward the subject and press the ▲ button while pressing the shutter button halfway.
- ▶ When AEL appears, the exposure will be locked.
- If you release your finger from the shutter button and press the ▲ button again, AEL will disappear and AE will unlock.

2 Compose the scene and shoot.

Shooting with the FE Lock

Just as with the AE lock, you can lock the exposure for shooting with the flash. FE stands for “Flash Exposure”.

1 Choose (p. 85).



2 Lock the flash exposure.

- Point the camera toward the subject and press the ▲ button while pressing the shutter button halfway.
- ▶ The flash will fire and when FEL appears, the flash output will be retained.
- If you release your finger from the shutter button and press the ▲ button again, FEL will disappear and FE will unlock.





3 Compose the scene and shoot.

Shooting with Slow Synchro

You can make the main subject, such as people, appear bright by having the camera provide the appropriate illumination with the flash. At the same time, you can use a slow shutter speed to brighten the background that the light from the flash cannot reach.



1 Choose .

- After pressing the  button, press the  buttons to choose , then press the  button.
- ▶ Once set,  will appear on the screen.

2 Shoot.

- Even if the flash fires, ensure that the main subject does not move until the shutter sound ends.





Attach the camera to a tripod to prevent the camera from moving and blurring the image. Additionally, you should set the [IS Mode] to [Off] when shooting with a tripod (p. 160). **A3300 IS** **A3200 IS**

Red-Eye Correction

You can automatically correct red-eye that occurs in images taken with the flash.





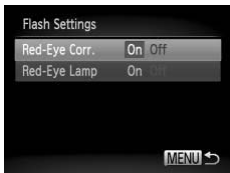

1 Choose [Flash Settings].

- Press the **MENU** button to choose [Flash Settings] from the  tab, then press the  button.



2 Choose the setting.

- Press the   buttons to choose [Red-Eye Corr.], then press the   buttons to choose [On].
- ▶ Once set,  will appear on the screen.



Red-eye correction may be applied to areas other than red eyes. For example, when red make-up has been used around eyes.





- You can also correct recorded images (p. 134).
- You can also display the screen in Step 2 by pressing the  button, then the **MENU** button.

Checking for Shut Eyes

When the camera detects the possibility that people have their eyes shut,  appears on the screen.





1 Choose [Blink Detection].

- Press the **MENU** button to choose [Blink Detection] from the  tab, then press the   buttons to choose [On].

2 Shoot.

- ▶ When a person with shut eyes is detected, a frame and  appear on the screen.



- This function is only available for the last image shot when you have set the camera to 2 or more shots in  or  mode.
- Not available in  mode.

Shooting Using a TV as the Display

You can use a TV to display the camera screen content while shooting.

- To connect the camera to a TV, follow the Steps in “Viewing Images on a TV” (p. 120).
- Shooting procedures are the same as when using the camera screen.







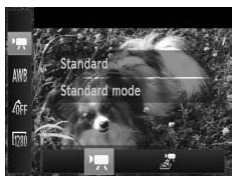

Changing the Movie Mode

You can choose among 2 different Movie modes.



Choose a Movie mode.

- After pressing the  button, press the  buttons to choose .
- Press the  buttons to choose a Movie mode, then press the .

	Standard	For shooting standard movies.
	Miniature Effect	You can shoot movies that look like a miniature model (p. 106).

Shoot Movies That Look Like a Miniature Model (Miniature Effect)



You can shoot movies that look like moving miniature models. You create the miniature model effect by choosing the upper and lower portions of the scene that will be blurred, and the playback speed, which makes people and objects in the scene move quickly during playback. Audio will not be recorded.

1 Choose .

- Follow the steps above to choose .
- ▶ A white frame (the area that will not be blurred) appears on the screen.



2 Choose the area to keep in focus.

- Press the .
- Move the zoom lever to change the frame size, and press the  buttons to change the frame position.



3 Choose a playback speed.

- Press the **MENU** button.
- Press the ◀▶ buttons to choose a playback speed.
- Press the **MENU** button to complete the setting and restore the shooting screen.

4 Shoot.

Playback Speeds and Estimated Playback Times (for 1 Min. Clips)

Speed	Playback Time
5x	Approx. 12 sec.
10x	Approx. 6 sec.
20x	Approx. 3 sec.



- If you press the  button in Step 2, the horizontal/vertical orientation of the frame will switch, and you can press the ◀▶ buttons to change the frame position when it is displayed vertically.
- Holding the camera vertically will change the orientation of the frame.
- Since you may not achieve the expected results depending on the shooting conditions, try taking some test shots first.

Changing the Image Quality

You can choose among 3 different image quality settings.

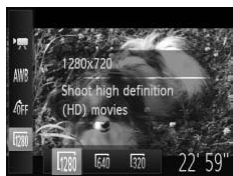

1 Choose the image quality setting.

- After pressing the **FUNC SET** button, press the **▲▼** buttons to choose **1280**.

2 Choose an option.

- Press the **◀▶** buttons to choose an option, then press the **FUNC SET** button.
- ▶ The option you set will appear on the screen.

Image Quality and Shooting Time per Memory Card

Image Quality	Recording Pixels, Frame Rate	Content	Memory Card Capacity	
			4 GB	16 GB
1280	1280 x 720 pixels, 30 frames/sec.	For shooting high-definition movies.	Approx. 22 min. 5 sec.	Approx. 1 hr. 30 min. 30 sec.
640	640 x 480 pixels, 30 frames/sec.	The image quality will be higher when compared with 320 , but the recording time will be shorter.	Approx. 50 min. 17 sec.	Approx. 3 hr. 25 min. 54 sec.
320	320 x 240 pixels, 30 frames/sec.	Since the file size is small, shooting time will increase, but the image quality will decrease.	Approx. 3 hr. 2 min. 52 sec.	Approx. 12 hr. 28 min. 47 sec.

- Based on Canon's testing standards.
- Recording will automatically stop when the clip file size reaches 4 GB, or when the recording time reaches approximately 10 minutes when shooting in **1280**, and approximately 1 hour when shooting in **640** or **320**.
- Recording may stop even if the maximum clip length has not been reached on some memory cards. SD Speed Class 4 or higher memory cards are recommended.

AE Lock/Exposure Shift

You can lock the exposure or change it in 1/3 steps within a range of ± 2 before shooting.



1 Focus.

- Press the shutter button halfway to focus.

2 Lock the exposure.

- After releasing the shutter button, press the \blacktriangle button to lock the exposure. The exposure shift bar appears.
- Press the \blacktriangle button again to release the lock.

3 Change the exposure.

- While watching the screen, press the \blacktriangleleft \blacktriangleright buttons to adjust the exposure.

4 Shoot.

Other Shooting Functions

The following functions can be used in the same way as for still images. Some functions, however, may not be available depending on the Shooting mode. Refer to “Functions Available in Each Shooting Mode” and “Shooting Menu” (pp. 176 – 191).

- **Zooming in More Closely On Subjects**

The optical zoom is not available while shooting. Be sure to set the optical zoom before shooting.

- **Using the Self-Timer (p. 60)**

The number of shots cannot be set.

- **Adjusting the White Balance (p. 86)**

- **Changing the Tone of an Image (My Colors) (p. 90)**

- **Shooting Close-ups (Macro) (p. 91)**

- **Shooting Far Away Subjects (Infinity) (p. 91)**

- **Shooting with the AF Lock (p. 96)**

- **Shooting Using a TV as the Display (p. 103)**

- **Turning Off the AF Assist Beam (p. 157)**

- **Displaying the Overlay (p. 159)**

- **Changing the IS-Mode Settings (p. 160)** **A3300 IS** **A3200 IS**

Editing

You can trim the beginnings and ends of recorded movies.





Movie Editing Panel



















Movie Editing Bar









1 Choose .

- Follow Steps 1 – 3 on p. 32 to choose , then press the  button.
- ▶ The movie editing panel and the movie editing bar will appear.

2 Set the editing range.



- Press the  buttons and choose  or .
- If you press the  buttons to move ,  will appear at points where the movie can be edited. If you choose , you can trim the beginning of the movie from . If you choose , you can trim the end of the movie from .
- Even if you move  to a point other than a , only the portion from the nearest  to the left will be trimmed when  is chosen. Only the portion from the nearest  to the right will be trimmed when  is chosen.

3 Check the edited movie.

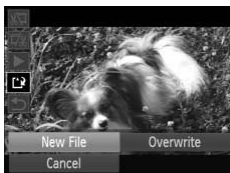
- Press the  buttons to choose  (Play), then press the  button. The edited movie will play.
- To edit the movie again, repeat Step 2.
- To cancel editing, press the  buttons to choose . After pressing the  button, press the  buttons to choose [OK], then press the  button again.



4 Save the edited movie.

- Press the ▲▼ buttons to choose [↵], then press the  button.
- Press the ◀▶ buttons to choose [New File], then press the  button.
- ▶ The movie will be saved as a new file.



- When [Overwrite] is chosen in Step 4, the unedited movie is overwritten with the edited movie, erasing the original.
- When there is not enough space left on the memory card, only [Overwrite] can be chosen.
- If the battery is depleted partway through saving, the edited movie clips may not be saved.
- When editing movies, you should use a fully charged battery, or an AC adapter kit (sold separately) (p. 39).

7

Using Various Playback and Editing Functions

This chapter explains various ways to play back and edit images.

- Press the  button to enter Playback mode before operating the camera.



- It may not be possible to play back or edit images that have been edited on a computer, have had their file names changed, or have been taken on a different camera.
- The edit function (pp. 131 – 135) cannot be used if the memory card does not have enough free space available.



Quickly Searching Images

Searching Images Using Index Display

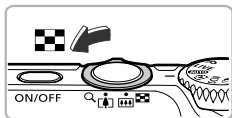
Displaying multiple images at the same time lets you quickly find the image you want.







1 Move the zoom lever toward .



- ▶ Images will display in an index.
- The number of images increase each time you move the lever toward .
- The number of images decrease each time you move the lever toward .



2 Choose an image.







- Press the     buttons to choose an image.
- ▶ An orange frame appears on the chosen image.
- Press the  button to display the chosen image by itself.

Searching Images by Scrolling

Pressing the   buttons for more than 1 second will display images in a line letting you quickly search them. You can also jump by the shooting date (Scroll Display).



Choose an image.

- If you set the camera to single image playback and press the   buttons for more than 1 second, the screen at the left will appear. Press the   buttons to choose an image.
- Press the  button to restore single image playback.
- Press the   buttons during scroll display to search images by the shooting date.



To turn off this effect, press the **MENU** button to choose [Scroll Display] from the  tab, then choose [Off].

Searching for Images Using the Jump Display

When there are many images on the memory card, you can search them by a specified method or image unit.



Position of currently displayed image

1 Choose a jump method.

- In single image playback, press the ▲ button.
- ▶ The jump method and the position of the currently displayed image will appear at the bottom of the screen.
- Press the ▲▼ buttons to choose the desired jump method.

2 Switch images.

- Press the ◀▶ buttons.
- ▶ Images will switch according to the chosen jump method.
- To return to single image playback, press the MENU button.

	Jump to Favorites	Displays the images tagged as favorites (p. 127).
	Jump 10 Images	Jumps over 10 images at a time.
	Jump 100 Images	Jumps over 100 images at a time.
	Jump Shot Date	Jumps to the first image in each shooting date group.
	Jump to My Category	Displays images in each category (p. 128).
	Jump to first	Jumps to still images only.
	Jump to Movie	Jumps to movies only.

- The number of images matching the jump method will display on the right side of the screen except for and .



If there are no images matching the jump method, the ◀▶ buttons will not function.

Viewing Slideshows

You can automatically play back images recorded to a memory card.



1 Choose [Slideshow].

- Press the **MENU** button to choose [Slideshow] from the tab, then press the button.



2 Choose a setting.

- Press the buttons to choose a menu item, then press the buttons to choose an option.

Repeat	Repeats playback of images
Play Time	Display time for each image
Effect	Transition effects when switching between images

3 Choose [Start].

- Press the buttons to choose [Start], then press the .
- ▶ The slideshow will start a few seconds after [Loading image...] displays.
- You can pause/restart a slideshow by pressing the again.
- Press the **MENU** button to stop the slideshow.



- If you press the buttons during playback, the image will switch. If you keep the buttons pressed, you can fast-forward through images.
- The power saving function (p. 54) does not work during slideshows.
- You cannot change [Play Time] if [Bubble] is chosen in [Effect].

Checking the Focus

You can magnify the area of a recorded image that was inside the AF Frame to check the focus.

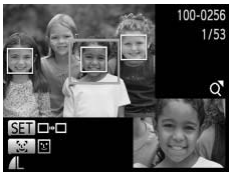

1 Press the DISP. button to switch to the focus check display (p. 46).

- For images with detected faces, you can also switch to the focus check display by pressing the button.
- ▶ A white frame will appear where the AF frame was when the focus was set.
- ▶ A gray frame will appear on a face detected during playback.
- ▶ The area within the orange frame appears magnified.



2 Switch frames.

- Move the zoom lever toward once.
- ▶ The screen shown on the left will appear.
- Press the button to switch between frames on detected faces. Press the button to move to other frames.

3 Change the magnification level or location.

- Use the zoom lever to change the display size, and the buttons to change the display position while checking the focus.
- Press the **MENU** button to reset the display to Step 1.



The focus check display is not available for movies.

Magnifying Images

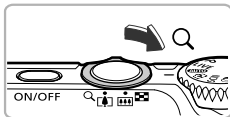

Approximate Location of Displayed Area

Move the zoom lever toward **Q**.

- The display will zoom in on the image and **SET** will appear. If you continue to hold the zoom lever, it will zoom in up to a maximum factor of approximately 10x.
- If you press the **▲▼◀▶** buttons, you can move the location of the displayed area.
- Move the zoom lever toward to zoom out, or continue to hold it to return to single image playback.
- When **SET** appears on the screen, press the **FUNC SET** button to switch to **SET** . Press the **◀▶** buttons to switch between images while zoomed. Press the **FUNC SET** button again to return to the original setting.



- In magnified display, pressing the **MENU** button restores single image playback.
- Movies cannot be magnified.

Displaying Various Images (Smart Shuffle)

The camera will choose four images based on the displayed image. If you choose one of those images, the camera will select four more images letting you enjoy playing back images in an unexpected order. This will work best if you take many shots of various scenes.



1 Choose [Smart Shuffle].

- Press the **MENU** button to choose [Smart Shuffle] from the tab, then press the button.
- ▶ Four images will appear as possibilities.



2 Choose an image.

- Press the buttons to choose the image you want to view next.
- ▶ The chosen image will be displayed in the middle, and the next four possibilities will appear.
- Press the button to display the middle image at full size. Press the button again to restore the original display.
- Press the **MENU** button to restore single image playback.



- Only still images shot with this camera will play back in Smart Shuffle.
- Smart Shuffle is not available in the following situations:
 - If there are less than 50 images taken with this camera on the memory card
 - If you play back images not supported by Smart Shuffle
 - During filtered playback

Changing Image Transitions

You can choose from 3 transition effects when switching between images in single image playback.



Choose [Transition].

- Press the **MENU** button to choose [Transition] from the tab, then press the buttons to choose a transition effect.

Viewing Images on a TV

Using the supplied AV cable (p. 2), you can connect the camera to a TV to view images you have shot.

1 Turn off the camera and TV.

2 Connect the camera to the TV.

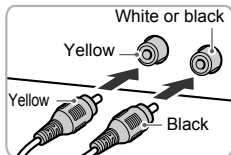
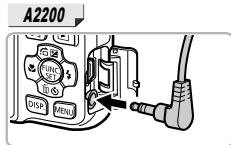
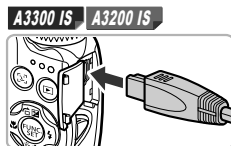

- Open the camera's terminal cover and fully insert the cable plug into the camera's terminal.
- Insert the cable plug fully into the video input terminals as shown in the illustration.

3 Turn on the TV and switch it to the input the cable is connected to.

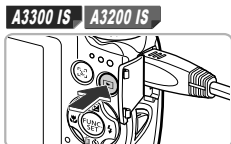

A2200



4 Turn on the camera.

- Press the  button to turn on the camera.
- ▶ The image will appear on the TV (nothing will appear on the screen of the camera).
- After you finish, turn off the camera and TV, and unplug the cable.



What if the images don't display correctly on the TV?

Images will not display correctly if the camera's video output setting (NTSC/PAL) does not match the TV system. Press the **MENU** button and choose [Video System] from the  tab to switch to the correct video system.

Protecting Images

You can protect important images so that they cannot be accidentally erased with the camera (pp. 28, 125).

Choose a selection method



1 Choose [Protect].

- Press the **MENU** button to choose [Protect] from the tab, then press the button.



2 Choose a selection method.

- Press the buttons to choose a selection method, then press the .
- Press the **MENU** button to complete the setting and restore the menu screen.



If you format the memory card (pp. 22, 151), protected images will also be erased.



Protected images cannot be erased with the camera's erase function. To erase an image, cancel protection settings first.

Choosing Images Individually

1 Choose [Select].

- Follow Step 2 above to choose [Select], then press the .

2 Choose images.

- Press the buttons to choose an image, then press the .
- ▶ will appear on the screen.
- Press the again to deselect the image. will disappear.
- To choose additional images, repeat the above procedure.





3 Protect the image.

- If you press the **MENU** button, a confirmation screen will appear.
- Press the **◀▶** buttons to choose [OK], then press the **FUNC. SET** button.



If you switch to Shooting mode or turn off the power before performing the operations in Step 3, images will not be protected.

Select Range

1 Choose [Select Range].

- Follow Step 2 on p. 122 to choose [Select Range], then press the **FUNC. SET** button.



2 Choose a starting image.

- Press the **FUNC. SET** button.



- Press the **◀▶** buttons to choose an image, then press the **FUNC. SET** button.



3 Choose an ending image.

- Press the **▶** button to choose [Last image], then press the **FUNC SET** button.



- Press the **◀▶** buttons to choose an image, then press the **FUNC SET** button.
- You cannot choose images before the first image.



4 Protect images.

- Press the **▼** button to choose [Protect], then press the **FUNC SET** button.

Choose All Images

1 Choose [All Images].

- Follow Step 2 on p. 122 to choose [All Images], then press the **FUNC SET** button.



2 Protect images.

- Press the **▲▼** buttons to choose [Protect], then press the **FUNC SET** button.



You can unlock groups of protected images if you choose [Unlock] in Step 4, while in [Select Range] or Step 2 while in [All Images].

Erasing All Images

You can erase all images at once. Since erased images cannot be recovered, exercise adequate caution before erasing. Protected images (p. 122) cannot be erased.

Choose a selection method



1 Choose [Erase].

- Press the **MENU** button to choose [Erase] from the tab, then press the button.

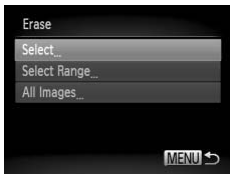

2 Choose a selection method.

- Press the buttons to choose a selection method, then press the button.
- Press the **MENU** button to restore the menu screen.

Choosing Images Individually

1 Choose [Select].

- Follow Step 2 above to choose [Select], then press the button.



2 Choose an image.

- Press the buttons to choose an image, then press the button.
- will appear on the screen.
- Press the button again to deselect the image. will disappear.
- To choose additional images, repeat the above procedure.



3 Erase.

- If you press the **MENU** button, a confirmation screen will appear.
- Press the ◀▶ buttons to choose [OK], then press the  button.

Select Range

1 Choose [Select Range].

- Follow Step 2 on p. 125 to choose [Select Range], then press the  button.

2 Choose images.

- Follow Steps 2 and 3 on p. 123 to choose images.



3 Erase.

- Press the ▼ button to choose [Erase], then press the  button.

Choose All Images



1 Choose [All Images].

- Follow Step 2 on p. 125 to choose [All Images], then press the  button.

2 Erase.

- Press the ◀▶ buttons to choose [OK], then press the  button.

Tagging Images as Favorites

When you tag images as favorites, you can easily categorize just those images. You can also filter out just those images for viewing (p. 115).

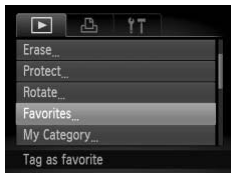

1 Choose [Favorites].

- Press the **MENU** button to choose [Favorites] from the tab, then press the button.



2 Choose an image.

- Press the buttons to choose an image, then press the .
- ▶ will appear on the screen.
- Press the again to untag the image. disappears.
- To choose additional images, repeat the above procedure.

3 Complete the setting.

- If you press the **MENU** button, a confirmation screen will appear.
- Press the buttons to choose [OK], then press the .



If you switch to Shooting mode or turn off the power before completing the setting in Step 3, images will not be tagged as favorites.



If you use Windows 7 or Windows Vista and transfer tagged images to the computer, they will be given a star rating of 3 (★★★☆☆) (except for movies).

Organizing Images by Category (My Category)

You can organize images into categories, then choose the categories to filter and play back (p. 115).



Images are automatically categorized by shooting condition as they are shot.

: Images with detected faces, or images shot in or .

: Images detected as , or in **AUTO** or modes, or images shot in or .

: Images shot in , or .

Choosing a Selection Method

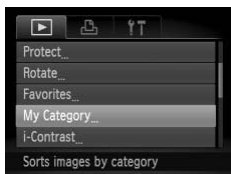

1 Choose [My Category].

- Press the **MENU** button to choose [My Category] from the tab, then press the button.

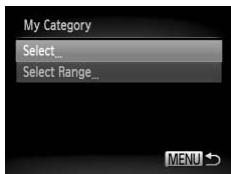

2 Choose a selection method.

- Press the buttons to choose a selection method, then press the button.
- Press the **MENU** button to restore the menu screen.

Choosing Images Individually

1 Choose [Select].

- Follow Step 2 above to choose [Select], then press the button.

2 Choose an image.

- Press the buttons to choose an image.

3 Choose a category.

- Press the buttons to choose a category, then press the button.



Organizing Images by Category (My Category)

- ▶ ✓ will appear on the screen.
- Press the  button again to deselect the image. ✓ will disappear.
- To choose additional images, repeat the above procedure.



4 Complete the setting.

- If you press the **MENU** button, a confirmation screen will appear.
- Press the ◀▶ buttons to choose [OK], then press the .



If you switch to Shooting mode or turn off the power before completing the setting in Step 4, images will not be tagged as My Category.

Select Range

1 Choose [Select Range].

- Follow Step 2 on p. 128 to choose [Select Range], then press the .

2 Choose images.

- Follow Steps 2 and 3 on p. 123 to choose images.

3 Choose a category.

- Press the ▼ button to choose an item, then press the ◀▶ buttons to choose a category.



4 Complete the setting.

- Press the ▼ button to choose [Select], then press the .



If you choose [Deselect] in Step 4, you can deselect all of the images in the [Select Range] category.

Rotating Images

You can change the orientation of an image and save it.

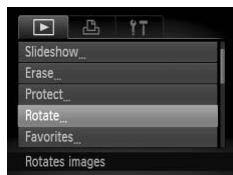

1 Choose [Rotate].

- Press the **MENU** button to choose [Rotate] from the tab, then press the button.



2 Rotate the image.

- Press the buttons to choose an image.
- ▶ The image will rotate 90° with each press of the button.
- Press the **MENU** button to restore the menu screen.



- Movies with an image quality setting of cannot be rotated.
- Images cannot be rotated if [Auto Rotate] is set to [Off] (p. 161).

Resizing Images

You can resize images to a lower pixel setting and save the resized image as a separate file.

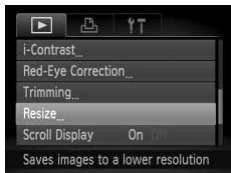

1 Choose [Resize].

- Press the **MENU** button to choose [Resize] from the tab, then press the button.

2 Choose an image.

- Press the buttons to choose an image, then press the button.

3 Choose an image size.

- Press the buttons to choose an option, then press the button.
 - ▶ [Save new image?] will appear on the screen.



4 Save the new image.

- Press the buttons to choose [OK], then press the button.
 - ▶ The image will be saved as a new file.

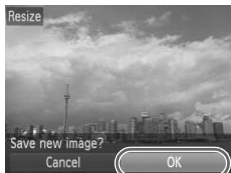

5 Display the new image.

- When you press the **MENU** button, [Display new image?] will appear on the screen.
- Press the buttons to choose [Yes], then press the button.
 - ▶ The saved image will be displayed.



- You cannot resize an image to a larger size.
- Images recorded at a pixel setting of **M** (p. 64), or saved as **XS** in Step 3 cannot be edited.
- Movies cannot be edited.

Trimming

You can cut out a portion of a recorded image and save it as a new image file.



1 Choose [Trimming].

- Press the **MENU** button to choose [Trimming] from the **▶** tab, then press the **FUNC SET** button.

2 Choose an image.

- Press the **◀▶** buttons to choose an image, then press the **FUNC SET** button.

3 Adjust the trimming area.

- ▶ A frame will appear around the portion of the image to be trimmed.
- ▶ The original image will display in the upper left and the trimmed image will display in the lower right.
- If you move the zoom lever to the left or right, you can change the frame size.
- If you press the **▲▼◀▶** buttons, you can move the frame.
- If you press the **DISP.** button, you can change the frame orientation.
- In an image with detected faces, gray frames appear around the faces located in the upper left image. The frames can be used for trimming. You can switch between frames by pressing the **[F]** button.
- After pressing the **FUNC SET** button, press the **◀▶** buttons to choose [OK], then press the **FUNC SET** button again.

Trimming Area

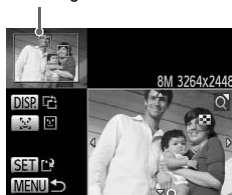

Trimming Area Display

Recorded pixels after trimming



4 Save as a new image and display.

- Follow Steps 4 and 5 on p. 131.



- Images recorded at a pixel setting of **S** or **W** (p. 64), or images resized to **XS** (p. 131) cannot be edited.
- The width and height ratio of an image that can be trimmed is fixed at 4:3.
- The number of recorded pixels in a trimmed image will be smaller than before trimming.
- Movies cannot be edited.

Correcting the Brightness (i-Contrast)

The camera can detect areas in an image, such as faces or backgrounds, that are too dark and automatically adjust them to the optimum brightness. Also, when the overall image is lacking in contrast, the camera will automatically correct the image for a sharper impression. You can choose from 4 levels of correction, and save the image as a new file.

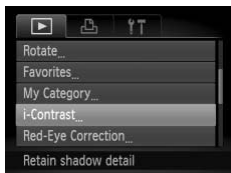

1 Choose [i-Contrast].

- Press the **MENU** button to choose [i-Contrast] from the tab, then press the button.

2 Choose an image.

- Press the buttons to choose an image, then press the button.

3 Choose an option.

- Press the buttons to choose an option, then press the button.

4 Save as a new image and display.

- Follow Steps 4 and 5 on p. 131.



- Under some conditions, the image may appear coarse or not be corrected properly.
- Repeatedly adjusting the same image may cause it to become coarse.



What if the image wasn't corrected by the [Auto] option as well as you would like?

Choose [Low], [Medium] or [High] and adjust the image.



Movies cannot be corrected.

Correcting the Red-Eye Effect

You can automatically correct red eyes in images and save them as new files.

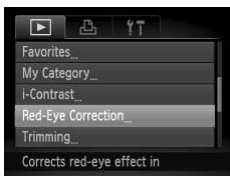

1 Choose [Red-Eye Correction].

- Press the **MENU** button to choose [Red-Eye Correction] from the tab, then press the button.

2 Choose an image.

- Press the buttons to choose an image.

3 Correct the image.

- Press the button.
 - ▶ Red-eye detected by the camera will be corrected and a frame will appear around the corrected portion.
- You can magnify or reduce the size of the image using the procedures in “Magnifying Images” (p. 118).

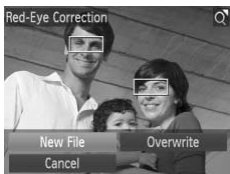

4 Save as a new image and display.

- Press the buttons to choose [New File], then press the button.
 - ▶ The image will be saved as a new file.
- Follow Step 5 on p. 131.



- Some images may not be corrected properly.
- When [Overwrite] in Step 4 is chosen, the uncorrected image is overwritten with the corrected data, erasing the original image.
- Protected images cannot be overwritten.



Movies cannot be corrected.



8

Printing

This chapter explains how to choose images for printing, and print using a Canon-brand PictBridge compliant printer (sold separately).

Canon-Brand PictBridge Compliant Printers

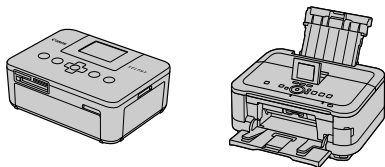

This chapter uses Canon-brand SELPHY CP series printers in the explanations. The displayed screens and available functions will differ depending on the printer. Please also refer to the *Printer User Guide*.

Printing Images

Easy Print

You can easily print the pictures you take by connecting the camera to a PictBridge compliant printer (sold separately) using the supplied interface cable (p. 2).

1 Turn off the camera and printer.

2 Connect the camera to the printer.

A3300 IS A3200 IS

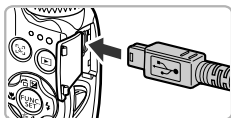

- Open the cover and insert the cable's small plug firmly into the camera terminal in the direction shown.

A2200

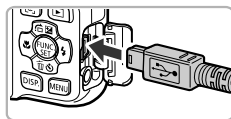

- Insert the cable's large plug into the printer. For connection details, refer to the user guide provided with the printer.

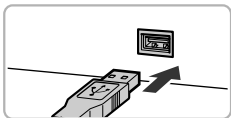

3 Turn on the printer.

4 Turn on the camera.

A3300 IS A3200 IS

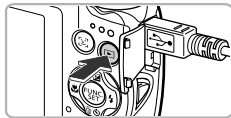

- Press the  button to turn on the camera.

A2200

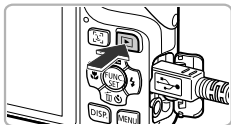

▶ SET will appear on the screen.



5 Choose an image.

- Press the ◀▶ buttons to choose an image, then press the button.



6 Print images.

- Press the ▲▼ buttons to choose [Print], then press the button.
- ▶ Printing will start.
- If you want to print additional images, repeat Steps 5 and 6 after printing has completed.
- After printing has completed, turn off the camera and printer, and unplug the interface cable.



- Refer to p. 40 for Canon-brand Pictbridge compliant printers (sold separately).
- Index printing is not available on certain Canon-brand PictBridge compliant printers (sold separately).

Making Print Settings



1 Connect the camera to the printer.

- Follow Steps 1 – 5 on p. 138 to display the screen on the left.

2 Choose a menu option.

- Press the ▲▼ buttons to choose an option.

3 Choose the option settings.

- Press the ◀▶ buttons to choose the option setting.

	Default	Follows the printer's settings.
	Date	Prints the date.
	File No.	Prints the file number.
	Both	Prints both the date and file no.
	Off	—
	Default	Follows the printer's settings.
	Off	—
	On	Uses shooting information to optimize print settings.
	Red-Eye1	Corrects red-eye.
	Red-Eye2*	Uses [NR], [Face] and [Red-Eye1] to correct the image.
	Vivid*	Greens in trees, and blues in the sky and ocean are enhanced to be more vivid.
	NR*	Reduces image noise.
	Vivid+NR*	Uses both [Vivid] and [NR] to correct the image.
Face *	Corrects brightness for dark faces, such as in backlit shots.	
	No. of Copies	Choose the number of copies.
Trimming	—	Choose the area for printing.
Paper Settings	—	Sets the paper size and layout.

* Only appears when connected to a PIXMA series printer.

Trimming and Printing (Trimming)

You can cut out a portion of an image for printing.

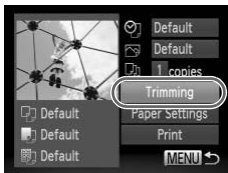

1 Choose [Trimming].

- Follow Steps 1 – 2 on p. 140 to choose [Trimming], then press the **FUNC/SET** button.
- ▶ A frame will appear around the portion of the image to be trimmed.



2 Choose the trimming area.

- Move the zoom lever to can change the frame size.
- Press the **▲▼◀▶** buttons to change the frame position.
- Press the **DISP.** button to rotate the frame.
- Press the **FUNC/SET** button to complete the setting.

3 Print.

- Follow Step 6 on p. 139 to print.



- You may not be able to trim images depending on the aspect ratio, or if they are too small.
- Trimming photos with embedded dates may not show the dates properly.

Choosing the Paper Size and Layout for Printing



1 Choose [Paper Settings].

- Follow Steps 1 – 2 on p. 140 to choose [Paper Settings], then press the  button.

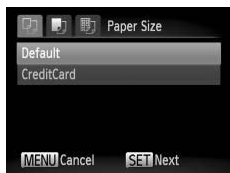

2 Choose a paper size.

- Press the ▲▼ buttons to choose an option, then press the  button.



3 Choose a paper type.

- Press the ▲▼ buttons to choose an option, then press the  button.



4 Choose a layout.

- Press the ▲▼ buttons to choose a layout, then press the  button.
- Press the ◀▶ buttons to set the number of prints when [N-up] is chosen.

5 Print.

Available Layout Options

Default	Follows the printer's settings.
Bordered	Prints with a border.
Borderless	Prints without a border.
N-up	Choose how many copies of an image are printed on a sheet.
ID Photo	Prints ID photos. Only images with the same resolution as the camera's L (Large) recording pixel setting can be chosen.
Fixed Size	Choose the print size. Choose from 3.5 x 5 in., postcard and wide sized prints.

Printing ID Photos

1 Choose [ID Photo].

- Follow Steps 1 – 4 on p. 142 to choose [ID Photo], then press the  button.



2 Choose the length of the long side and short side.

- Press the ▲▼ buttons to choose an item.
- Press the ◀▶ buttons to choose the length, then press the  button.

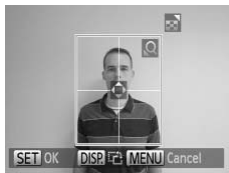

3 Choose the printing area.



- Follow Step 2 on p. 141 to choose the printing area.

4 Print.

Printing Movies



1 Connect the camera to the printer.

- Follow Steps 1 – 5 on p. 138 to choose a movie.
- Press the ◀▶ buttons to choose , then press the  button to display the screen on the left.

2 Choose a printing method.

- Press the ▲▼ buttons to choose , then press the ◀▶ buttons to choose a printing method.

3 Print.

Printing methods for movies

Single	Prints currently displayed scene as a still image.
Sequence	Prints a sequence of images from a specified scene on a single sheet of paper. If [Caption] is set to [On], you can print the folder number, file number, and the elapsed time for the frame at the same time.



- Pressing the  button during printing will cancel printing.
- [ID Photo] and [Sequence] cannot be chosen on Canon-brand PictBridge compliant printers from CP720/CP730 and earlier models.

Choosing Images for Printing (DPOF)

You can choose up to 998 images on a memory card for printing and specify settings such as the number of copies so that they can be printed together (p. 148) or processed at a photo developer service. These selection methods comply with the DPOF (Digital Print Order Format) standards.





Movies cannot be chosen.

Print Settings

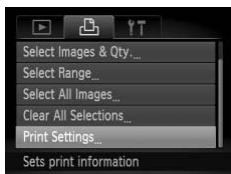
You can set the print type, date and file number. These settings apply to all images chosen for printing.



1 Choose [Print Settings].

- Press the **MENU** button to choose [Print Settings] from the  tab, then press the  button.

2 Adjust the settings.

- Press the **▲▼** buttons to choose a menu item, then press the **◀▶** buttons to choose an option.
- Press the **MENU** button to complete the setting and restore the menu screen.

Print Type	Standard	Prints 1 image per page.
	Index	Prints several reduced size images per page.
	Both	Prints both standard and index formats.
Date	On	Prints the shooting date.
	Off	—
File No.	On	Prints the file number.
	Off	—
Clear DPOF data	On	Removes all print settings after printing.
	Off	—



- Some printers or photo developer services may not be able to reflect all of the settings in the prints.
-  may appear when using a memory card with print settings set by a different camera. These settings will be overwritten with those set by your camera.
- If [Date] is set to [On], some printers may print the date twice.





- With [Index] chosen, the [Date] and [File No.] options cannot be set to [On] at the same time.
- The date will be printed in the style set in the [Date/Time] function in the  tab, which can be chosen after you press the **MENU** button (p. 19).







Choosing the Number of Copies





1 Choose [Select Images & Qty.].

- Press the **MENU** button to choose [Select Images & Qty.] from the  tab, then press the  button.

2 Choose an image.

- Press the   buttons to choose an image, then press the  button.
- ▶ You will be able to set the number of print copies.
- If you choose images in [Index],  appears on the screen. Press the  button again to deselect the image.  will disappear.

3 Set the number of prints.

- Press the   buttons to set the number of prints (maximum 99).
- Repeat Steps 2 and 3 to choose other images and the number of prints for each.
- You cannot set the number of copies for index prints. You can only choose which images to print (as shown in Step 2).
- Press the **MENU** button to complete the setting and restore the menu screen.



Select Range



1 Choose [Select Range].

- Follow Step 1 on p. 146 to choose [Select Range], then press the button.

2 Choose images.

- Follow Steps 2 and 3 on p. 123 to choose images.

3 Make print settings.

- Press the to choose [Order], then press the button.

Set All Images to Print Once



1 Choose [Select All Images].

- Follow Step 1 on p. 146 to choose [Select All Images], then press the button.

2 Make print settings.

- Press the to choose [OK], then press the button.

Clearing All Selections

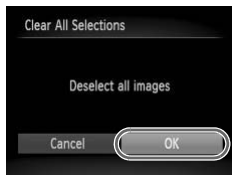

1 Choose [Clear All Selections].

- Follow Step 1 on p. 146 to choose [Clear All Selections], then press the button.

2 All selections will be cleared.

- Press the to choose [OK], then press the button.



Printing chosen images (DPOF)



- When there are images added to the print list (pp. 145 – 147), the screen on the left will appear when you connect the camera to a PictBridge compliant printer. Press the ▲▼ buttons to choose [Print now], then press the  button to easily print images added to the print list.
- If you stop the printer during printing and start again, it will start from the next print.

9

Customizing Camera Settings

You can customize various settings to suit your shooting preferences. The first part of this chapter explains convenient and commonly used functions. The latter part explains how to change shooting and playback settings to suit your purposes.



Changing Camera Settings

You can customize convenient and commonly used functions from the **FUNC** tab (p. 49).

Changing Sounds

You can change each of the camera's operation sounds.



- Choose [Sound Options], then press the **FUNC SET** button.
- Press the **▲▼** buttons to choose a menu item.
- Press the **◀▶** buttons to choose an option.

- | | |
|---|---|
| 1 | Preset sounds
(cannot be modified) |
| 2 | You can use the included software to
change the sounds (p. 2). |



You cannot change the sound settings in **1.4**.

Turning Off Hints & Tips

When you choose an item in the **FUNC.** menu (p. 48) or **MENU** (p. 49), a description of the function (hints and tips) is displayed. You can turn off this function.





- Choose [Hints & Tips], then press the **◀▶** buttons to choose [Off].

Low Level Memory Card Formatting

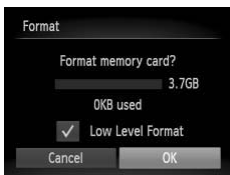
Perform low level formatting when [Memory card error] appears, the camera does not operate properly, you think that the recording/reading speed of a memory card has dropped, or recording suddenly stops while shooting a movie. As you cannot retrieve the erased data, exercise adequate caution before formatting the memory card.



1 Choose [Low Level Format].

- Choose [Format], then press the  button.
- Press the \blacktriangle / \blacktriangledown buttons to choose [Low Level Format], then press the \blacktriangleleft / \blacktriangleright buttons to display \checkmark .
- Press the \blacktriangle / \blacktriangledown / \blacktriangleleft / \blacktriangleright buttons to choose [OK], then press the  button.

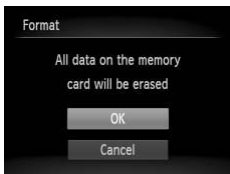

2 Start the low level format.

- Press the \blacktriangle / \blacktriangledown buttons to choose [OK], then press the  button.
- ▶ Low level formatting starts.
- ▶ When low level formatting ends, [Memory card formatting complete] will appear on the screen.

3 Complete the low level format.

- Press the  button.





- Low level formatting may take longer than standard formatting (p. 22), since all recorded data is erased.
- You can stop a low level format of a memory card by choosing [Stop]. When stopping low level formatting, the data will be erased but the memory card can be used without problem.

Changing the Start-up Screen

You can change the start-up screen that appears when you turn on the camera.







- Choose [Start-up Image], then press the  button.
- Press the   buttons to choose an option.

<input type="checkbox"/>	No start-up image
1	Preset images (cannot be modified)
2	Preset images You can set recorded images, and use the included software to change the images.







Registering Recorded Images as the Start-up Screen

When you press the  button and set the camera to Playback mode, you can register an image.



- Choose [Start-up Image], then press the  button.
- Press the   buttons to choose [2], then press the  button.



- Press the   buttons to choose an image, then press the  button.
- Press the   buttons to choose [OK], then press the  button to complete registration.



Any previously registered start-up image will be overwritten when registering a new start-up image.



Register the start-up image or sounds with the included software

The dedicated operation sounds and start-up images on the included software can be registered to the camera. Refer to the *Software Guide* for details.

Changing the File Number Assignment

Images you shoot are automatically assigned file numbers in the order they were taken, from 0001 – 9999, and saved to folders of up to 2,000 images. You can change the file number assignment.



- Choose [File Numbering], then press the ◀▶ buttons to choose an option.

Continuous	Even if you shoot using a new memory card, the file numbers are assigned consecutively until an image with the number 9999 is taken/saved.
Auto Reset	If you replace the memory card with a new one, or a new folder is created, file numbering begins with 0001 again.



- If you use a memory card already containing images, the newly assigned file numbers may continue the existing numbering for both [Continuous] and [Auto Reset]. If you want to start over with file number 0001, format the memory card before use (p. 22).
- Refer to the *Software Guide* for information regarding folder structure or image types.

Creating Folders by Shooting Date

Images are saved into folders created each month, however, you can also create folders by shooting date.



- Choose [Create Folder], then press the ◀▶ buttons to choose [Daily].
- Images will be saved into folders created on each shooting date.

Changing the Lens Retract Time

For safety reasons, the lens retracts about 1 minute after pressing the ▶ button when in a Shooting mode (p. 27). If you want the lens to retract immediately when you press the ▶ button, set the retract time to [0 sec.].



- Choose [Lens Retract], then press the ◀▶ buttons to choose [0 sec.].

Turning Off the Power Saving Function

You can set the power saving function (p. 54) to [Off]. Setting it to [On] is recommended to save battery power.





- Choose [Power Saving], then press the  button.
- Press the ▲▼ buttons to choose [Auto Power Down], then press the ◀▶ buttons to choose [Off].
- If you set the power saving function to [Off], be sure to turn the camera off after use.

Setting the Screen Shut-Off Time

You can adjust the time the screen takes to shut off automatically (p. 54). This also works when [Auto Power Down] is set to [Off].







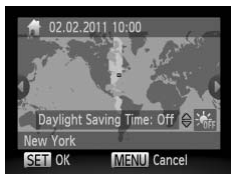
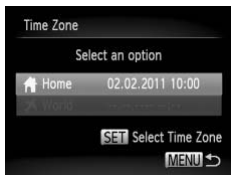

- Choose [Power Saving], then press the  button.
- Press the  buttons to choose [Display Off], then use the  buttons to choose a time.
- In order to save battery power, you should choose less than [1 min.].

Using the World Clock

When traveling abroad, you can record images with local dates and times simply by switching the time zone setting. If you pre-register the destination time zones, you can enjoy the convenience of not having to switch the Date/Time settings.





1 Set the home time zone.

- Choose [Time Zone], then press the  button.
- When setting this for the first time, check the information that displays on the screen at the left, then press the  button.
- Press the  buttons to choose the home time zone.
- To set daylight saving time (adds 1 hour), press the  buttons to choose .
- Press the  button.



2 Set the world time zone.

- Press the ▲▼ buttons to choose [✈ World], then press the  button.
- Press the ◀▶ buttons to choose the world time zone.
- You can also set the daylight saving time as in Step 1.
- Press the  button.

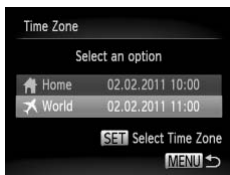

3 Choose the world time zone.

- Press the ▲▼ buttons to choose [✈ World], then press the **MENU** button.
- ▶ ✈ will appear on the shooting screen (p. 171).



If you change the date or time in the ✈ setting (p. 19), your [🏠 Home] time and date will automatically change.

Changing Shooting Function Settings

If you set the mode dial to **P**, you can change the settings in the  tab (p. 49).



Before attempting to shoot using a function explained in this section in modes other than **P**, check if the function is available in those modes (pp. 176 – 191).

Turning Off the AF Assist Beam

The lamp will automatically light to assist focusing in low light conditions when you press the shutter button halfway. You can turn off the lamp.

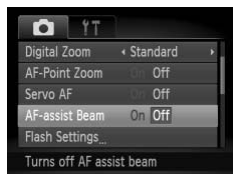



- Choose [AF-assist Beam], then press the  buttons to choose [Off].

Turning Off the Red-Eye Reduction Function

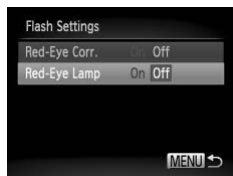
The red-eye reduction lamp lights in order to reduce the red-eye effect that occurs when shooting in dark conditions with the flash. You can turn off this function.



- Choose [Flash Settings], then press the  button.
- Press the  buttons to choose [Red-Eye Lamp], then press the  buttons to choose [Off].

Changing the Image Display Time Right After Shooting

You can change the length of time the images display right after shooting.

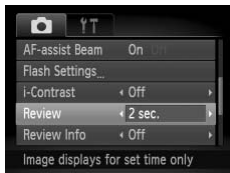

- Choose [Review], then press the ◀▶ buttons to choose an option.

2 – 10 sec.	Displays images for the set time.
Hold	The image displays until you press the shutter button halfway.
Off	Images will not display.

Changing the Way the Image Displays Right After Shooting

You can change the way the image displays right after shooting.

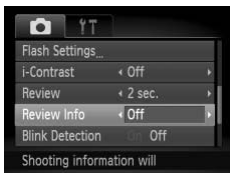

- Choose [Review Info], then press the ◀▶ buttons to choose an option.

Off	Displays the image only.
Detailed	Displays detailed information (p. 173).
Focus Check	The area inside the AF frame is magnified, allowing you to check the focus. The procedure is the same as in "Checking the Focus" (p. 117).

Displaying the Overlay

You can display grid lines for vertical and horizontal guidance, or a 3:2 guide to confirm the printable area for 3.5" x 5" and postcard size prints.



- Choose [Disp. Overlay], then press the **◀▶** buttons to choose an option.

Off	–
Grid Lines	A grid overlays the screen.
3:2 Guide	Gray bars appear on the top and bottom of the screen. This area will not print when printing on paper with a 3:2 aspect ratio.
Both	Both grid lines, and the 3:2 guide appear.



- In **W**, you cannot set [3:2 Guide] or [Both].
- Grid lines will not be recorded on the image.
- The gray areas displayed with [3:2 Guide] are the areas that will not be printed. The actual image recorded will include the portion in the gray areas.

Changing the IS-Mode Settings A3300 IS A3200 IS

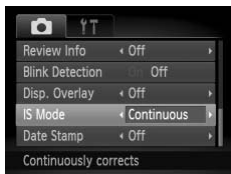

- Choose [IS Mode], then press the ◀▶ buttons to choose an option.

Continuous	Image stabilization is always on. You can confirm the effects directly on the display, which makes it easier to check the composition or focus. When shooting movies, the camera also reduces strong camera shake, for example when walking (Dynamic mode).
Off	–
Shoot Only*	Image stabilization is only active at the moment of shooting.
Panning*	Image stabilization only counters up and down motion. This option is recommended for shooting objects moving horizontally.

* Setting changes to [Continuous] when shooting movies.



- If camera shake is too strong, attach the camera to a tripod. You should also set the IS Mode to [Off] when the camera is attached to a tripod.
- When using [Panning], hold the camera horizontally to shoot. Image stabilization does not work when the camera is held vertically.

Changing Playback Function Settings

You can adjust the settings in the  tab by pressing the  button (p. 49).

Choosing the Image that First Displays in Playback

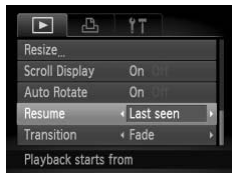

- Choose [Resume], then press the ◀▶ buttons to choose an option.

Last seen	Resumes with the image last viewed.
Last shot	Resumes with the most recently shot image.

Turning off the Auto Rotate Function

When you play back images on the camera, images shot in vertical orientation automatically rotate and display vertically. You can turn off this function.

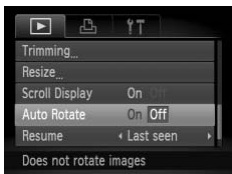

- Select [Auto Rotate], then press the ◀▶ buttons to select [Off].



- Images cannot be rotated (p. 130) if you have set [Auto Rotate] to [Off]. Rotated images will also appear in their original orientation.
- In Smart Shuffle (p. 119), even if [Auto Rotate] is set to [Off], images taken vertically will be displayed vertically, while rotated images will appear in their rotated orientation.

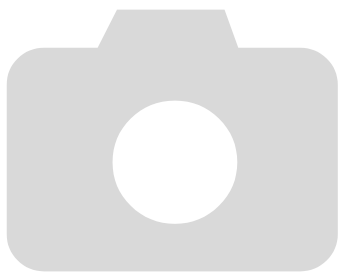

10

Useful Information

This chapter introduces how to use the AC adapter kit (sold separately), troubleshooting tips, and contains lists of functions and items that appear on the screen.

Using Household Power

If you use AC Adapter Kit ACK-DC60 (sold separately), you can use the camera without worrying about how much charge is left in the battery.

1 Turn off the camera.

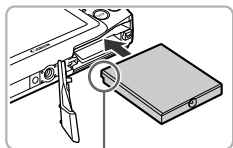

Terminals

2 Insert the coupler.

- Follow Step 2 on p. 16 to open the cover, then insert the coupler as shown until it locks into place with a click.
- Follow Step 5 on p. 17 to close the cover.

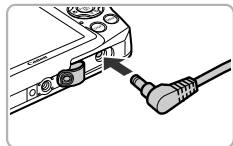

3 Plug the cord into the coupler.

- Open the cover and fully insert the plug into the coupler.

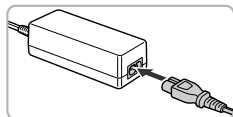

4 Connect the power cord.

- Connect the power cord to the compact power adapter, then plug the other end into a power outlet.
- Turn the camera on to use it.
- After you finish, turn off the camera and unplug the power cord from the power outlet.



Do not unplug the plug or power cord with the camera turned on. This could erase images you have taken or damage the camera.

Troubleshooting

If you think there is a problem with the camera, first check the following. If the items below do not solve your problem, contact a Canon Customer Support Help Desk as listed on the included customer support list.

Power

You pressed the power button, but nothing happened.

- Confirm that the battery is the correct type, and is not depleted (p. 15).
- Confirm that the battery is properly inserted (p. 16).
- Confirm that the memory card/battery cover is securely closed (p. 17).
- If the battery terminals are dirty, battery performance will decrease. Clean the terminals with a cotton swab and re-insert the battery several times.

Battery is consumed quickly.

- Battery performance decreases at low temperatures. Warm the battery, for example, by placing it in your pocket with the terminal cover on.

Lens will not retract.

- Do not open the memory card/battery cover while the power is on. After closing the memory card/battery cover, turn the power on then back off (p. 17).

TV output

Image is distorted or not showing on TV (p. 121).

Shooting

Cannot shoot.

- Set the mode dial to a Shooting mode (p. 44).
- When in Playback mode (p. 21), press the shutter button halfway (p. 23).

Screen does not display properly in dark places (p. 47).

Screen does not display properly while shooting.

Please note, the following will not be recorded in still images, but will be recorded in movies.

- When the camera is subjected to powerful light sources, the display may darken.
- When shooting under fluorescent or LED lighting, the screen may flicker.
- When shooting bright light sources, a bar of light (purplish red) may appear on the screen.

A flashing appears on the screen and the shot cannot be taken even though the shutter button was pressed fully (p. 26).

appears when the shutter button is pressed halfway (p. 56).

- Set the [IS mode] to [Continuous] (p. 160). **A3300 IS** **A3200 IS**
- Set the flash to  (p. 85).
- Increase the ISO speed (p. 87).
- Attach the camera to a tripod. Additionally, you should set the [IS Mode] to [Off] when shooting with a tripod (p. 160). **A3300 IS** **A3200 IS**

Image is blurred.

- Press the shutter button halfway to focus on the subject, then press fully to shoot (p. 23).
- Shoot the subject within the focusing distance (p. 194).
- Set the [AF-assist Beam] to [On] (p. 157).
- Confirm that functions which you do not intend to use (macro, etc.) are not set.
- Shoot using the focus lock or AF lock (pp. 93, 96).

Even when you press the shutter button halfway, the AF frame does not appear, and the camera does not focus.

- If you center on the light and dark contrasting area of the subject and push the shutter button halfway, or repeatedly push the shutter button halfway, the AF frame will appear and the camera will focus.

Subject is too dark.

- Set the flash to  (p. 85).
- Correct the brightness with exposure compensation (p. 85).
- Adjust the image with i-Contrast (pp. 88, 134).
- Use spot metering or AE Lock to shoot (pp. 99, 100).

Subject is too bright (overexposed).



- Set the flash to  (p. 56).
- Correct the brightness with exposure compensation (p. 85).
- Use spot metering or AE Lock to shoot (pp. 99, 100).
- Reduce the light illuminating the subject.

Image is dark even though the flash fired (p. 26).

- Shoot within an appropriate distance for flash photography (p. 85).
- Increase the ISO speed (p. 87).

Image taken using the flash is too bright (overexposed).

- Shoot within an appropriate distance for flash photography (p. 85).
- Set the flash to  (p. 56).

White dots appear on the image when shooting with the flash.

- Light from the flash has reflected off dust particles or other objects in the air.

Image appears rough or grainy.

- Shoot with the ISO speed on a lower setting (p. 87).
- Depending on the Shooting mode, when shooting in a high ISO speed the image may appear rough or grainy (pp. 69, 70).

Eyes appear red (p. 102).

- Set the [Red-Eye Lamp] to [On] (p. 157). When shooting with the flash, the lamp (on the front of the camera) lights (p. 42), and for approximately 1 second while the camera is reducing red-eye, it is not possible to shoot. It is more effective if the subject is looking directly at the lamp. Even better results can be obtained by increasing the lighting in indoor settings or approaching closer to the subject.
- Correct images with red-eye correction (p. 135).

Recording images to the memory card takes a long time, or continuous shooting slows down.

- Perform a low-level format of the memory card in the camera (p. 151).

Cannot make settings for shooting functions or FUNC. menu.

- The items in which settings can be made differ depending on the shooting mode. Refer to “Functions Available in Each Shooting Mode” and “Shooting Menu” (pp. 176 – 191).

Cannot operate buttons.

- When the mode dial is set to , some buttons cannot be used (p. 29).

Shooting movies**Correct shooting time does not display, or stops.**

- Format the memory card in the camera, or use a memory card capable of recording at high speeds. Even when the shooting time does not display properly, the recorded video will be the length that it was actually shot (pp. 22, 32).

! appeared on the screen and shooting ended automatically.

The camera's internal memory was insufficient. Try one of the following:

- Perform a low-level format of the memory card in the camera (p. 151).
- Change the image quality setting (p. 108).
- Use a memory card capable of recording at high speeds (p. 108).

Zoom does not operate (p. 110).**Playback****Cannot play back images or movies.**

- If the file name or folder structure is changed on a computer, you may not be able to play back images or movies. Refer to the *Software Guide* for information regarding folder structure or file names.

Playback stops, or audio cuts out.

- Use a memory card that has had a low-level format performed on it with this camera (p. 151).
- If you copy a movie to a memory card that reads slowly, playback may interrupt momentarily.
- Depending on its capabilities, when playing movies on a computer, frames may drop or the audio may cut out.

Cannot operate buttons.

- When the mode dial is set to , some buttons cannot be used (p. 29).





Memory Card**Memory card not recognized.**

- Leaving the card in the camera, turn the camera off then on again (p. 17).

Computer

Cannot transfer images to a computer.

It may be possible to solve the problem when the camera is connected to a computer via cable by reducing the transfer speed.

- Press the  button to enter Playback mode. Then press and hold the **MENU** button and press the  and  buttons together. In the screen that appears, press the  buttons to choose [B] and press the  button.

List of Messages That Appear on the Screen

If error messages appear on the screen, try one of the following solutions.

No memory card

- The memory card is not installed in the correct direction. Install the memory card in the correct direction (p. 17).

Memory card locked

- The SD memory card, SDHC memory card or SDXC memory card's write protect tab is set to "LOCK". Unlock the write protect tab (pp. 16, 17).

Cannot record!

- You attempted to shoot an image without a memory card. Install the memory card in the correct direction to shoot (p. 17).

Memory card error (p. 151)

- If the same message appears even when a formatted memory card is installed in the correct direction, contact a Canon Customer Support Help Desk (p. 17).

Insufficient space on card

- There is not enough free space on the memory card to shoot (pp. 24, 29, 30, 55, 83) or edit images (pp. 131 – 135). Erase the images (pp. 28, 125) to open space for new images, or insert an empty memory card (p. 17).

Change the battery pack. (p. 16)

No Image.

- There are no images recorded on the memory card that can be displayed.

Protected! (p. 122)

Unidentified Image/Incompatible JPEG/Image too large./Cannot play back AVI/RAW

- Unsupported images, or images with corrupted data cannot be displayed.
- Images manipulated on a computer, that have had their file name changed, or have been taken with a different camera may not display.

Cannot magnify!/Cannot play back this content in Smart Shuffle/Cannot rotate/Cannot modify image/Cannot register this image!/Cannot modify/ Cannot assign to category/Unselectable image.

- Incompatible images cannot be magnified (p. 118), played back in Smart Shuffle (p. 119), tagged as favorites (p. 127), rotated (p. 130), edited (pp. 131 – 135), registered to the start-up screen (p. 152), categorized (p. 128), or added to a print list (p. 145).
- Images manipulated on a computer, that have had their file name changed, or have been taken with a different camera may not be magnified, played back in Smart Shuffle, tagged as favorites, rotated, edited, registered to the start-up screen, categorized, or added to a print list.
- Movies cannot be magnified (p. 118), played back in Smart Shuffle (p. 119), edited (pp. 131 – 135), added to a print list (p. 145), or registered to the start-up screen (p. 152).

Invalid selection range

- When choosing the selection range (pp. 123, 126, 129, 147), you tried to choose a starting image that was after the last image or you tried to choose an ending image that was before the starting image.

Exceeded selection limit

- You chose more than 998 images in print settings. Choose less than 998 images (p. 146).
- Print settings could not be saved correctly. Reduce the number of selected images and try again (p. 146).
- You chose 501 or more images in Protect (p. 122), Erase (p. 125), Favorites (p. 127), My Category (p. 128) or Print Settings (p. 145).

Communication error

- Images could not be transferred to the computer or printed due to the large amount of images (approx. 1000) stored on the memory card. Use a commercially available USB card reader to transfer the images. Insert the memory card into the printer's card slot to print.

Naming error!

- The folder or image could not be created because there is an image with the same file name as the folder or image that the camera is attempting to create, or the highest possible file number has already been reached. In the **⏏** menu, change [File Numbering] to [Auto Reset] (p. 153) or format the memory card (p. 22).

Lens Error

- This error can occur if you hold the lens while it is in motion or when using it in a location with excessive dust or sand in the air.
- If this error message continues to appear, contact a Canon Customer Support Help Desk as there may be a problem with the lens.

A camera error was detected (Error number)

- If an error code appears directly after taking a picture, the shot may not have been recorded. Check the image in Playback mode.
- If this error code reappears, note the Error number (Exx) and contact a Canon Customer Support Help Desk as there may be a problem with the camera.

File Error

- Photos from other cameras or images that have been altered using computer software may not be printable.

Print error

- Check the paper size settings. If this message appears when the settings are correct, turn the printer off and back on, then make the settings again.

Ink absorber full

- Contact a Canon Customer Support Help Desk for an ink absorber replacement.

Information Displayed on the Screen

Shooting (Information Display)

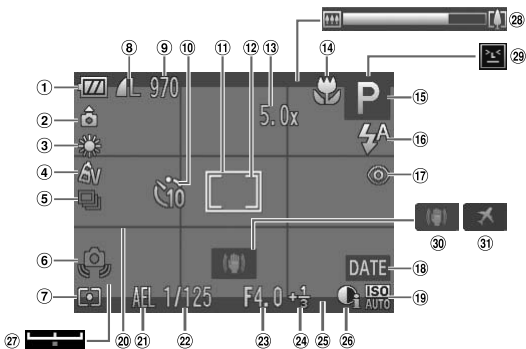

- | | | |
|--|---|--|
| ① Battery Charge Indicator (p. 15) | ⑩ Self-Timer (pp. 60, 61, 62) | ⑲ ISO Speed (p. 87) |
| ② Camera Orientation* (p. 15) | ⑪ AF Frame (p. 92) | ⑳ Grid Lines (p. 159) |
| ③ White Balance (p. 86) | ⑫ Spot AE Point Frame (p. 99) | ㉑ AE Lock (p. 100), FE Lock (p. 100) |
| ④ My Colors (p. 90) | ⑬ Digital Zoom Magnification (p. 57) / Digital Tele-converter (p. 58) | ㉒ Shutter Speed |
| ⑤ Drive Mode (p. 89) | ⑭ Focusing Range (p. 91), AF Lock (p. 96) | ㉓ Aperture Value |
| ⑥ Camera Shake Warning (p. 26) | ⑮ Shooting Mode (p. 176), Scene Icon (p. 172) | ㉔ Exposure Compensation Amount (p. 85) |
| ⑦ Metering Method (p. 99) | ⑯ Flash Mode (pp. 56, 85, 101) | ㉕ 3:2 Guide (p. 159) |
| ⑧ Compression (Image Quality) (p. 63) / Recording Pixels (pp. 63, 108) | ⑰ Red-Eye Correction (p. 135) | ㉖ i-Contrast (p. 88) |
| ⑨ Still Images: Recordable Shots (p. 64) / Movies: Remaining Time (p. 108) | ⑱ Date Stamp (p. 59) | ㉗ Exposure Shift Bar (p. 109) |
| | | ㉘ Zoom Bar (p. 24) |
| | | ㉙ Blink Detection (p. 103) |
| | | ㉚ Image Stabilizer (p. 160) |
| | | A3300 IS A3200 IS |
| | | ㉛ Time Zone (p. 155) |

* : Standard, : Held vertically

When shooting, the camera detects if it is held vertically or horizontally, and adjusts settings accordingly for the best shot. It also detects orientation during playback, so you can hold the camera in either orientation and it will automatically rotate images for correct viewing. This function may not operate correctly when the camera is pointed straight up or down.

Scene Icons

In **AUTO** mode, the camera displays an icon for the scene it has determined and then automatically focuses and selects the optimum settings for subject brightness and color.

Subject Background	People			Non-Human Subjects			Icon Background Color
	When Moving	With Strong Facial Shadows		When Moving	When Close		
Bright				AUTO			Gray
Backlit			—				
Including Blue Skies				AUTO			Light Blue
Backlit			—				
Sunsets	—				—		Orange
Spotlights							
Dark				AUTO			Dark Blue
When Using Tripod	*	—		*	—		





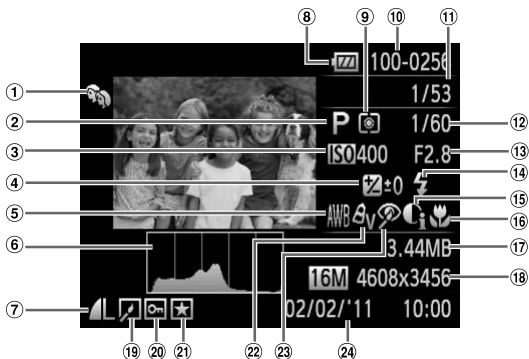





* Appears when the scene is dark and the camera is attached to a tripod.

Playback (Detailed Information Display)



- | | | |
|--|---|--|
| ① My Category (p. 128) | ⑨ Metering Method (p. 99) | ⑱ Still Images: Recording Pixels (p. 63) |
| ② Shooting Mode (p. 176) | ⑩ Folder Number – File Number (p. 153) | ⑳ Movies: Movie Length (p. 108) |
| ③ ISO Speed (p. 87) | ⑪ Displayed image number / Total number of images | ㉑ Image Editing (pp. 131 – 135) |
| ④ Exposure Compensation Amount (p. 85), Exposure Shift Amount (p. 109) | ⑫ Shutter Speed | ㉒ Protect (p. 122) |
| ⑤ White Balance (p. 86) | ⑬ Aperture Value, Image Quality (Movies) (p. 108) | ㉓ Favorites (p. 127) |
| ⑥ Histogram (p. 47) | ⑭ Flash (p. 85) | ㉔ My Colors (p. 90) |
| ⑦ Compression (Image Quality) (p. 63) / Recording Pixels (pp. 63, 108), MOV (Movies) | ⑮ i-Contrast (pp. 88, 134) | ㉕ Red-Eye Correction (pp. 102, 135) |
| ⑧ Battery Charge Indicator (p. 15) | ⑯ Focusing Range (p. 91) | ㉖ Shooting Date and Time (p. 19) |
| | ⑰ File Size (pp. 64, 108) | |

Summary of Movie Control Panel in “Viewing Movies” (p. 32)

	Exit
	Playback
	Slow motion playback (You can use the ◀▶ buttons to adjust the speed. Sound will not play back.)
	Skip backward* (Continues to skip backward if button is held.)
	Previous frame (Rewind if you hold down the  button.)
	Next frame (Fast forward if you hold down the  button.)
	Skip forward* (Continues to skip forward if button is held.)
	Edit (p. 111)
	Appears when connected to a PictBridge compliant printer (p. 138).

* Displays the frame of approx. 4 sec. before or after the current frame.



You can skip forward and skip backward during movie playback by pressing the ◀▶ buttons.

Handling Precautions

- This camera is a high-precision electronic device. Do not drop it or subject it to strong impacts.
- Never place the camera close to magnets, motors or other devices that generate strong electromagnetic fields. Exposure to strong magnetic fields may cause malfunctions or corrupt image data.
- If water droplets or dirt become stuck on the camera or screen, wipe with a dry soft cloth or eyeglass wiper. Do not rub or apply force.
- Never use cleaners containing organic solvents to wipe the camera or screen.
- Use a commercially available blower brush to remove dust from the lens. For stubborn dirt contact a Canon Customer Support Help Desk as listed on the customer support leaflet supplied with your camera.
- When you move the camera rapidly from cold to hot temperatures, condensation may form on the internal or external surfaces of the camera. To avoid condensation, put the camera in an airtight, resealable plastic bag and let it adjust to temperature changes slowly before removing it from the bag.
- If condensation has formed on the camera, stop using it immediately, as continued use may damage the camera. Remove the battery and memory card, and wait until the moisture has completely evaporated before resuming use.

Functions Available in Each Shooting Mode

A3300 IS **A3200 IS**

Function		Shooting modes				SCN		
		P	LIVE	AUTO				
Exposure Compensation (p. 85)		○	*1	—	—	○	○	○
Self-Timer (pp. 60, 61, 62)		○	○	○	○	○	○	○
		○	○	○	—	○	○	○
		○	○	○	—	○	○	○
		○	○	○	—	○	○	○
Custom Timer (p. 62)	Delay *2	○	○	○	—	○	○	○
	Shots *3	○	○	○	—	○	○	○
Flash (pp. 56, 85, 101)		○	○	○	○	○	○	○
		○	○	—	—	○	○	○
		○	○	*4	*4	—	*5	—
		○	○	○	○	○	○	○
AE Lock (p. 100)/FE Lock *6 (p. 100)		○	—	—	—	—	—	—
AE Lock/Exposure Shift (Movies) (p. 109)		—	—	—	—	—	—	—
AF Lock (p. 96)		○	○	—	—	—	—	—
Focusing Range (p. 91)		○	○	○	○	○	○	○
		○	○	—	—	○	○	—
		○	○	—	—	○	○	—
Face Select (p. 98)		○	○	○	—	○	○	○
Screen Display (p. 46)	No Information Display	○	○	○	—	○	○	○
	Information Display	○	○	○	○	○	○	○

*1 Set in [Dark] and [Light].

*2 Cannot be set to 0 seconds when in modes where the number of shots cannot be set.

*3 Fixed to 1 shot when in modes where the number of shots cannot be set.

*4 Cannot be set, but switches to depending on the circumstances.

*5 Cannot be set, but switches to when the flash fires.

*6 FE Lock not available when set to .

Functions Available in Each Shooting Mode

SCN																		
○	○	○	○	○	○	○	○	—	○	○	○	○	○	—	○	—	—	
○	○	○	○	○	○	○	○	○	○	○	○	○	○	○	○	○	○	
—	—	—	○	○	○	○	○	○	○	○	○	○	○	○	—	○	○	
—	—	—	○	○	○	○	○	○	○	○	○	○	○	○	—	○	○	
—	—	—	○	○	○	○	○	○	○	○	○	○	○	○	—	○	○	
—	—	—	○	○	○	○	○	○	○	○	○	○	○	○	—	○	○	
○	○	○	○	○	○	○	—	—	○	○	○	○	○	○	—	—	—	
○	○	○	—	○	○	○	—	○	○	○	○	○	○	○	—	—	—	
—	—	—	—	—	—	—	—	+5	—	—	—	—	—	—	—	—	—	
○	○	○	○	○	○	○	○	○	○	○	○	○	○	○	○	—	—	
—	—	—	—	—	—	—	—	—	—	—	—	—	—	—	—	—	—	
—	—	—	—	—	—	—	—	—	—	—	—	—	—	—	—	○	—	
—	—	—	—	—	—	—	—	○	—	—	—	—	—	—	—	○	—	
○	○	○	○	○	○	○	○	○	○	○	○	○	○	○	○	○	○	
—	—	—	○	○	○	○	—	○	○	○	○	○	○	○	○	○	○	
—	—	—	○	○	○	○	—	○	○	○	○	○	○	○	○	○	○	
○	○	○	○	○	○	○	—	○	—	—	○	○	○	○	○	—	—	
—	—	—	○	○	○	○	○	○	—	—	—	—	○	○	○	○	—	
○	○	○	○	○	○	○	○	○	○	○	○	○	○	○	○	○	○	

○ Selectable, or set automatically. — Not selectable.

Functions Available in Each Shooting Mode

		FUNC. Menu						
		Shooting modes				SCN		
Function		P	LIVE	AUTO				
ISO Speed (p. 87)		○	○	○	○	○	○	○
		○	—	—	—	—	—	—
		○	—	—	—	—	—	—
		○	—	—	—	—	—	—
		○	—	—	—	—	—	—
		○	—	—	—	—	—	—
		○	—	—	—	—	—	—
White Balance (p. 86)		○	○	○	○	○	○	○
		○	—	—	—	—	—	—
		○	—	—	—	—	—	—
		○	—	—	—	—	—	—
		○	—	—	—	—	—	—
		○	—	—	—	—	—	—
		○	—	—	—	—	—	—
My Colors (p. 90)		○	○	○	○	○	○	○
		○	—	—	—	—	—	—
		○	—	—	—	—	—	—
		○	—	—	—	—	—	—
		○	—	—	—	—	—	—
		○	—	—	—	—	—	—
Drive Mode (p. 89)		○	○	○	○	○	○	○
		○	—	—	—	○	○	○
Metering Method (p. 99)		○	○	○	○	○	○	○
		○	—	—	—	—	—	—
		○	—	—	—	—	—	—
Recording Pixels (p. 63)		○	○	○	○	○	○	○
		○	—	○	—	○	○	○
		○	—	○	—	○	○	○
		—	—	—	—	—	—	—
		○	—	○	—	○	○	○
		○	—	○	—	○	○	○
Compression Ratio (Image Quality) (p. 63)		○	○	○	○	○	○	○
		○	—	○	—	○	○	○
Image Quality (Movies) (p. 108)		—	—	—	—	—	—	—
		—	—	—	—	—	—	—
		—	—	—	—	—	—	—

*7 White balance is not selectable. *8 Contrast, sharpness and color saturation can be set in 5 levels.

Functions Available in Each Shooting Mode

FUNC. Menu																	
SCN									[Globe Icon]						[Image Icon]	[Video Icon]	
[Smiley Icon]	[Smiley Icon]	[Smiley Icon]	[Smiley Icon]	[Smiley Icon]	[Smiley Icon]	[Smiley Icon]	[Smiley Icon]	[Smiley Icon]	[Smiley Icon]	[Smiley Icon]	[Smiley Icon]	[Smiley Icon]	[Smiley Icon]	[Smiley Icon]	[Smiley Icon]	[Smiley Icon]	[Smiley Icon]
○	○	○	○	○	○	○	○	○	○	○	○	○	○	○	○	○	○
—	—	—	—	—	—	—	—	○	—	—	—	—	—	—	—	—	—
—	—	—	—	—	—	—	—	○	—	—	—	—	—	—	—	—	—
—	—	—	—	—	—	—	—	○	—	—	—	—	—	—	—	—	—
—	—	—	—	—	—	—	—	○	—	—	—	—	—	—	—	—	—
—	—	—	—	—	—	—	—	○	—	—	—	—	—	—	—	—	—
—	—	—	—	—	—	—	—	○	—	—	—	—	—	—	—	—	—
○	○	○	○	○	○	○	○	○	○	○	○	○	○	○	○	○	○
○	○	○	○	—	—	—	—	○	—	—	—	—	—	—	○	○	—
○	○	○	○	—	—	—	—	○	—	—	—	—	—	—	○	○	—
○	○	○	○	—	—	—	—	○	—	—	—	—	—	—	○	○	—
○	○	○	○	—	—	—	—	○	—	—	—	—	—	—	○	○	—
○	○	○	○	—	—	—	—	○	—	—	—	—	—	—	○	○	—
○	○	○	○	—	—	—	—	○	—	—	—	—	—	—	○	○	—
○	○	○	○	○	○	○	○	○	○	○	○	○	○	○	○	○	○
—	—	—	○	○	○	○	○	—	○	○	○	○	○	○	○	○	—
○	○	○	○	○	○	○	○	○	○	○	○	○	○	○	○	○	○
—	—	—	—	—	—	—	—	—	—	—	—	—	—	—	—	—	—
○	○	○	—	○	○	○	○	○	○	○	○	○	○	○	○	—	—
○	○	○	—	○	○	○	○	○	—	—	—	○	○	○	○	—	—
○	○	○	—	○	○	○	○	○	—	—	—	○	○	○	○	—	—
—	—	—	○	—	—	—	—	—	—	—	—	—	—	—	—	—	—
○	○	○	—	○	○	○	○	○	—	—	—	○	○	○	○	—	—
○	○	○	—	○	○	○	○	○	—	—	—	○	○	○	○	—	—
○	○	○	○	○	○	○	○	○	○	○	○	○	○	○	○	○	○
○	○	○	○	○	○	○	○	○	○	○	○	○	○	○	○	○	○
—	—	—	—	—	—	—	—	—	—	—	—	—	—	—	—	○	○
—	—	—	—	—	—	—	—	—	—	—	—	—	—	—	—	○	○
—	—	—	—	—	—	—	—	—	—	—	—	—	—	—	—	○	—

○ Selectable, or set automatically. — Not selectable.

Functions Available in Each Shooting Mode

A2200

Shooting modes		P	LIVE	AUTO		SCN			
Function									
Exposure Compensation (p. 85)		○	*1	—	—	○	○	○	○
Self-Timer (pp. 60, 61, 62)		○	○	○	○	○	○	○	○
		○	○	○	—	○	○	○	○
		○	○	○	—	○	○	○	○
		○	○	○	—	○	○	○	○
Custom Timer (p. 62)	Delay *2	○	○	○	—	○	○	○	○
	Shots *3	○	○	○	—	○	○	○	○
Flash (pp. 56, 85, 101)		○	○	○	○	○	○	○	○
		○	○	—	—	○	○	○	○
		○	○	*4	*4	—	—	*5	—
		○	○	○	○	○	○	○	○
AE Lock (p. 100)/FE Lock *6 (p. 100)		○	—	—	—	—	—	—	—
AE Lock/Exposure Shift (Movies) (p. 109)		—	—	—	—	—	—	—	—
AF Lock (p. 96)		○	○	—	—	—	—	—	—
Focusing Range (p. 91)		○	○	○	○	○	○	○	○
		○	○	—	—	○	○	○	—
		○	○	—	—	○	○	○	—
Face Select (p. 98)		○	○	○	—	○	○	○	○
Screen Display (p. 46)	No Information Display	○	○	○	—	○	○	○	○
	Information Display	○	○	○	○	○	○	○	○

*1 Set in [Dark] and [Light].

*2 Cannot be set to 0 seconds when in modes where the number of shots cannot be set.

*3 Fixed to 1 shot when in modes where the number of shots cannot be set.

*4 Cannot be set, but switches to depending on the circumstances.

*5 Cannot be set, but switches to when the flash fires.

*6 FE Lock not available when set to .

Functions Available in Each Shooting Mode

SCN																		
○	○	○	○	○	○	○	○	—	○	○	○	○	○	—	○	—	—	
○	○	○	○	○	○	○	○	○	○	○	○	○	○	○	○	○	○	
—	—	—	○	○	○	○	○	○	○	○	○	○	○	○	—	○	○	
—	—	—	○	○	○	○	○	○	○	○	○	○	○	○	—	○	○	
—	—	—	○	○	○	○	○	○	○	○	○	○	○	○	—	○	○	
—	—	—	○	○	○	○	○	○	○	○	○	○	○	○	—	—	—	
○	○	○	○	○	○	○	—	—	○	○	○	○	○	○	—	—	—	
○	○	○	—	○	○	○	—	○	○	○	○	○	○	○	—	—	—	
—	—	—	—	—	—	—	—	*5	—	—	—	—	—	—	—	—	—	
○	○	○	○	○	○	○	○	○	○	○	○	○	○	○	○	—	—	
—	—	—	—	—	—	—	—	—	—	—	—	—	—	—	—	—	—	
—	—	—	—	—	—	—	—	—	—	—	—	—	—	—	—	○	—	
—	—	—	—	—	—	—	—	○	—	—	—	—	—	—	—	○	—	
○	○	○	○	○	○	○	○	○	○	○	○	○	○	○	○	○	○	
—	—	—	○	○	○	○	—	○	○	○	○	○	○	○	○	○	○	
—	—	—	○	○	○	○	—	○	○	○	○	○	○	○	○	○	○	
○	○	○	○	○	○	○	—	○	—	—	○	○	○	○	○	—	—	
—	—	—	○	○	○	○	○	○	—	—	—	—	○	○	○	○	—	
○	○	○	○	○	○	○	○	○	○	○	○	○	○	○	○	○	○	

○ Selectable, or set automatically. — Not selectable.

Functions Available in Each Shooting Mode

		FUNC. Menu							
Function		Shooting modes				SCN			
		P	LIVE	AUTO					
ISO Speed (p. 87)	AUTO	○	○	○	○	○	○	○	
	80	○	—	—	—	—	—	—	
	100	○	—	—	—	—	—	—	
	200	○	—	—	—	—	—	—	
	400	○	—	—	—	—	—	—	
	800	○	—	—	—	—	—	—	
	1600	○	—	—	—	—	—	—	
White Balance (p. 86)	AWB	○	○	○	○	○	○	○	
		○	—	—	—	○	—	—	
		○	—	—	—	○	—	—	
		○	—	—	—	○	—	—	
		○	—	—	—	○	—	—	
		○	—	—	—	○	—	—	
		○	—	—	—	○	—	—	
My Colors (p. 90)	Off	○	○	○	○	○	○	○	
	Av	○	—	—	—	—	—	—	
	AN	○	—	—	—	—	—	—	
	*7	○	—	—	—	—	—	—	
	*7	○	—	—	—	—	—	—	
	*8	○	—	—	—	—	—	—	
Drive Mode (p. 89)		○	○	○	○	○	○	○	
		○	—	—	—	○	○	○	
Metering Method (p. 99)		○	○	○	○	○	○	○	
		○	—	—	—	—	—	—	
		○	—	—	—	—	—	—	
Recording Pixels (p. 63)	L	○	○	○	○	—	○	○	
	M1	○	—	○	—	—	○	○	
	M2	○	—	○	—	—	○	○	
	M	—	—	—	—	○	—	—	
	S	○	—	○	—	—	○	○	
	W	○	—	○	—	—	○	○	
Compression Ratio (Image Quality) (p. 63)		○	○	○	○	○	○	○	
		○	—	○	—	○	○	○	
Image Quality (Movies) (p. 108)	1280	—	—	—	—	—	—	—	
	640	—	—	—	—	—	—	—	
	320	—	—	—	—	—	—	—	

*7 White balance is not selectable. *8 Contrast, sharpness and color saturation can be set in 5 levels.

Functions Available in Each Shooting Mode





FUNC. Menu																	
SCN																	
○	○	○	○	○	○	○	○	○	—	○	○	○	○	○	○	○	○
—	—	—	—	—	—	—	—	○	—	—	—	—	—	—	—	—	—
—	—	—	—	—	—	—	—	○	—	—	—	—	—	—	—	—	—
—	—	—	—	—	—	—	—	○	—	—	—	—	—	—	—	—	—
—	—	—	—	—	—	—	—	○	—	—	—	—	—	—	—	—	—
—	—	—	—	—	—	—	—	○	—	—	—	—	—	—	—	—	—
○	○	○	○	○	○	○	○	○	○	○	○	○	○	○	○	○	○
○	○	○	○	—	—	—	—	○	—	—	—	—	—	—	○	○	—
○	○	○	○	—	—	—	—	○	—	—	—	—	—	—	○	○	—
○	○	○	○	—	—	—	—	○	—	—	—	—	—	—	○	○	—
○	○	○	○	—	—	—	—	○	—	—	—	—	—	—	○	○	—
○	○	○	○	—	—	—	—	○	—	—	—	—	—	—	○	○	—
○	○	○	○	—	—	—	—	○	—	—	—	—	—	—	○	○	—
○	○	○	○	○	○	○	○	○	○	○	○	○	○	○	○	○	○
—	—	—	○	○	○	○	○	○	—	○	○	○	○	○	○	○	—
○	○	○	○	○	○	○	○	○	○	○	○	○	○	○	○	○	○
—	—	—	—	—	—	—	—	—	—	—	—	—	—	—	—	—	—
○	○	○	—	○	○	○	○	○	○	○	○	○	○	○	○	—	—
○	○	○	—	○	○	○	○	○	—	—	—	○	○	○	○	—	—
○	○	○	—	○	○	○	○	○	—	—	—	○	○	○	○	—	—
—	—	—	○	—	—	—	—	—	—	—	—	—	—	—	—	—	—
○	○	○	—	○	○	○	○	○	—	—	—	○	○	○	○	—	—
○	○	○	—	○	○	○	○	○	—	—	—	○	○	○	○	—	—
○	○	○	○	○	○	○	○	○	○	○	○	○	○	○	○	—	—
○	○	○	○	○	○	○	○	○	○	○	○	○	○	○	○	—	—
—	—	—	—	—	—	—	—	—	—	—	—	—	—	—	—	○	○
—	—	—	—	—	—	—	—	—	—	—	—	—	—	—	—	○	○
—	—	—	—	—	—	—	—	—	—	—	—	—	—	—	—	○	—

○ Selectable, or set automatically. — Not selectable.

Menus

Shooting Menu

A3300 IS **A3200 IS**

Function		Shooting Modes				SCN		
		P	LIVE	AUTO				
AF Frame (p. 92)	Face AiAF *1	○	○	○	○	○	○	○
	Tracking AF	○	○	*2	—	○	○	○
	Center	○	○	—	—	○	○	○
AF Frame Size (p. 93) *3	Normal	○	○	—	—	○	○	○
	Small	○	○	—	—	○	○	○
Digital Zoom (p. 57)	Standard	○	○	○	○	○	○	○
	Off	○	○	○	—	○	○	○
	Digital Tele-converter *4	○	○	○	—	○	○	○
AF-Point Zoom (p. 95)	On	○	○	○	—	○	○	—
	Off	○	○	○	○	○	○	○
Servo AF (p. 97)	On	○	○	—	—	○	○	○
	Off *5	○	○	○	○	○	○	—
AF-assist Beam (p. 157)	On	○	○	○	*6	○	○	○
	Off	○	○	○	—	○	○	○
Flash Settings (pp. 102, 157)	Red-Eye Corr.	On	○	—	○	—	○	○
		Off	○	○	○	○	○	○
	Red-Eye Lamp	On	○	○	○	○	○	○
		Off	○	○	○	—	○	○
i-Contrast (p. 88)	Auto	○	—	○	○	—	—	—
	Off	○	○	—	—	○	○	○
Review (p. 158)	Off	○	○	○	—	○	○	○
	2 sec.	○	○	○	○	○	○	○
	– 10 sec.	○	○	○	—	○	○	○
	Hold	○	○	○	—	○	○	○
Review Info (p. 158)	Off	○	○	○	○	○	○	○
	Detailed	○	○	○	—	○	○	○
	Focus Check	○	○	○	—	○	○	○
Blink Detection (p. 103)	On	○	○	○	—	○	○	○
	Off	○	○	○	○	○	○	○

*1 Operation differs depending on the shooting mode when faces are not detected.

*2 Only available by pressing  button (p. 26).

*3 Available when the AF frame is set to [Center].

*4 **A3300 IS** : 1.6x/2.0x, **A3200 IS** : 1.7x/2.1x

*5 [On] when moving people are detected in (AUTO).

*6 [On] when the flash is set to  A.

SCN																	
○	○	○	○	○	○	○	○	—	○	—	—	○	○	○	○	○	—
—	—	—	○	○	○	○	○	—	○	—	—	—	○	○	○	○	—
—	—	—	○	○	○	○	○	○	○	○	—	○	○	○	○	○	—
—	—	—	○	○	○	○	○	○	○	○	—	○	○	○	○	○	—
○	○	○	—	○	○	○	○	○	○	—	—	—	○	○	○	○	—
○	○	○	○	○	○	○	○	○	○	○	—	—	○	○	○	○	—
○	○	○	○	○	○	○	○	—	○	—	—	—	○	○	○	○	—
○	○	○	○	○	○	○	○	○	○	○	○	○	○	○	○	○	○
—	—	—	○	○	○	○	○	—	—	—	—	—	○	○	○	○	—
○	○	○	○	○	○	○	○	○	○	○	○	○	○	○	○	○	○
○	○	○	○	○	○	○	○	—	○	○	○	○	○	○	○	○	○
—	○	○	○	○	○	○	○	○	○	○	○	○	○	○	○	○	○
○	○	○	○	○	○	○	○	—	○	—	—	—	—	—	—	—	—
○	○	○	○	○	○	○	○	—	○	○	○	○	○	○	○	—	—
○	○	○	○	○	○	○	○	—	○	○	○	○	○	○	○	—	—
○	○	○	○	○	○	○	○	—	○	○	○	○	○	○	○	—	—
—	—	—	○	—	—	—	—	—	—	—	—	—	—	—	—	—	—
○	○	○	—	○	○	○	○	○	○	○	○	○	○	○	○	○	—
○	○	○	○	○	○	○	○	○	○	○	○	○	○	○	○	○	—
○	○	○	○	○	○	○	○	○	○	○	○	○	○	○	○	○	—
○	○	○	○	○	○	○	○	○	○	○	○	○	○	○	○	○	—
○	○	○	○	○	○	○	○	○	○	○	○	○	○	○	○	○	—
○	○	○	○	○	○	○	○	○	○	○	○	○	○	○	○	○	—
○	○	○	○	○	○	○	○	—	—	—	—	—	○	○	○	○	—
○	○	○	○	○	○	○	○	○	○	○	○	○	○	○	○	○	○

○ Selectable, or set automatically. — Not selectable.

Shooting Modes		P	LIVE	AUTO		SCN		
Function								
Disp. Overlay (p. 159)	Off	<input type="radio"/>	<input type="radio"/>	<input type="radio"/>	<input type="radio"/>	<input type="radio"/>	<input type="radio"/>	<input type="radio"/>
	Grid Lines	<input type="radio"/>	<input type="radio"/>	<input type="radio"/>	<input type="checkbox"/>	<input type="radio"/>	<input type="radio"/>	<input type="radio"/>
	3:2 Guide	<input type="radio"/>	<input type="radio"/>	<input type="radio"/>	<input type="checkbox"/>	<input type="radio"/>	<input type="radio"/>	<input type="radio"/>
	Both	<input type="radio"/>	<input type="radio"/>	<input type="radio"/>	<input type="checkbox"/>	<input type="radio"/>	<input type="radio"/>	<input type="radio"/>
IS Mode (p. 160)	Off	<input type="radio"/>	<input type="radio"/>	<input type="checkbox"/>	<input type="checkbox"/>	<input type="radio"/>	<input type="radio"/>	<input type="radio"/>
	Continuous	<input type="radio"/>	<input type="radio"/>	<input type="radio"/>	<input type="radio"/>	<input type="radio"/>	<input type="radio"/>	<input type="radio"/>
	Shoot Only	<input type="radio"/>	<input type="radio"/>	<input type="checkbox"/>	<input type="checkbox"/>	<input type="radio"/>	<input type="radio"/>	<input type="radio"/>
	Panning	<input type="radio"/>	<input type="radio"/>	<input type="checkbox"/>	<input type="checkbox"/>	<input type="radio"/>	<input type="radio"/>	<input type="radio"/>
Date Stamp (p. 59)	Off	<input type="radio"/>	<input type="radio"/>	<input type="radio"/>	<input type="radio"/>	<input type="radio"/>	<input type="radio"/>	<input type="radio"/>
	Date	<input type="radio"/>	<input type="radio"/>	<input type="radio"/>	<input type="checkbox"/>	<input type="radio"/>	<input type="radio"/>	<input type="radio"/>
	Date & Time	<input type="radio"/>	<input type="radio"/>	<input type="radio"/>	<input type="checkbox"/>	<input type="radio"/>	<input type="radio"/>	<input type="radio"/>

Function		Shooting Modes				SCN			
		P	LIVE	AUTO					
AF Frame (p. 92)	Face AiAF *1	○	○	○	○	○	○	○	○
	Tracking AF	○	○	*2	—	○	○	○	○
	Center	○	○	—	—	○	○	○	○
AF Frame Size (p. 93) *3	Normal	○	○	—	—	○	○	○	○
	Small	○	○	—	—	○	○	○	○
Digital Zoom (p. 57)	Standard	○	○	○	○	—	○	○	○
	Off	○	○	○	—	○	○	○	○
	1.7x	○	○	○	—	—	○	○	○
	2.1x	○	○	○	—	—	○	○	○
AF-Point Zoom (p. 95)	On	○	○	○	—	○	○	○	—
	Off *4	○	○	○	○	○	○	○	○
Servo AF (p. 97)	On	○	○	—	—	○	○	○	○
	Off	○	○	○	○	○	○	○	—
AF-assist Beam (p. 157)	On	○	○	○	*5	○	○	○	○
	Off	○	○	○	—	○	○	○	○
Flash Settings (pp. 102, 157)	Red-Eye Corr.	On	○	—	○	—	○	○	○
		Off	○	○	○	○	○	○	○
	Red-Eye Lamp	On	○	○	○	○	○	○	○
		Off	○	○	○	—	○	○	○
i-Contrast (p. 88)	Auto	○	—	○	○	—	—	—	—
	Off	○	○	—	—	○	○	○	○
Review (p. 158)	Off	○	○	○	—	○	○	○	○
	2 sec.	○	○	○	○	○	○	○	○
	– 10 sec.	○	○	○	—	○	○	○	○
	Hold	○	○	○	—	○	○	○	○
Review Info (p. 158)	Off	○	○	○	○	○	○	○	○
	Detailed	○	○	○	—	○	○	○	○
	Focus Check	○	○	○	—	○	○	○	○
Blink Detection (p. 103)	On	○	○	○	—	○	○	○	○
	Off	○	○	○	○	○	○	○	○

*1 Operation differs depending on the shooting mode when faces are not detected.

*2 Only available by pressing button (p. 26).

*3 Available when the AF frame is set to [Center].

*4 [On] when moving people are detected in **AUTO**.

*5 [On] when the flash is set to A.



Shooting Modes		P	LIVE	AUTO		SCN			
Function									
Disp. Overlay (p. 159)	Off	<input type="radio"/>	<input type="radio"/>	<input type="radio"/>	<input type="radio"/>	<input type="radio"/>	<input type="radio"/>	<input type="radio"/>	<input type="radio"/>
	Grid Lines	<input type="radio"/>	<input type="radio"/>	<input type="radio"/>	—	<input type="radio"/>	<input type="radio"/>	<input type="radio"/>	<input type="radio"/>
	3:2 Guide	<input type="radio"/>	<input type="radio"/>	<input type="radio"/>	—	<input type="radio"/>	<input type="radio"/>	<input type="radio"/>	<input type="radio"/>
	Both	<input type="radio"/>	<input type="radio"/>	<input type="radio"/>	—	<input type="radio"/>	<input type="radio"/>	<input type="radio"/>	<input type="radio"/>
Date Stamp (p. 59)	Off	<input type="radio"/>	<input type="radio"/>	<input type="radio"/>	<input type="radio"/>	<input type="radio"/>	<input type="radio"/>	<input type="radio"/>	<input type="radio"/>
	Date	<input type="radio"/>	<input type="radio"/>	<input type="radio"/>	—	<input type="radio"/>	<input type="radio"/>	<input type="radio"/>	<input type="radio"/>
	Date & Time	<input type="radio"/>	<input type="radio"/>	<input type="radio"/>	—	<input type="radio"/>	<input type="radio"/>	<input type="radio"/>	<input type="radio"/>

Set up Menu

Item	Content	Ref. Page
Mute	On/Off*	p. 50
Volume	Set all operation sounds (5 levels).	p. 51
Sound Options	Set the sounds for each camera operation.	p. 150
Hints & Tips	On*/Off	p. 150
LCD Brightness	Sets screen brightness (5 levels).	p. 52
Start-up Image	Add an image as a start-up image.	p. 152
Format	Formats memory card, erasing all data	pp. 22, 151
File Numbering	Continuous*/Auto Reset	p. 153
Create Folder	Monthly*/Daily	p. 154
Lens Retract	1 min.*0 sec.	p. 154
Power Saving	Auto Power Down: On*/Off Display Off: 10, 20 or 30 sec./1*, 2 or 3 min.	pp. 54, 154, 155
Time Zone	Home*/World	p. 155
Date/Time	Date and time settings	p. 20
Video System	NTSC/PAL	p. 121
Language	Choose display language.	p. 21
Reset All	Returns camera to default settings.	p. 53

* Default setting

Playback Menu

Item	Content	Ref. Page
Smart Shuffle	Starts Smart Shuffle.	p. 119
Slideshow	Plays back images automatically.	p. 116
Erase	Erases images (Select, Select Range, All Images).	p. 125
Protect	Protects images (Select, Select Range, All Images).	p. 122
Rotate	Rotates images.	p. 130
Favorites	Tags or untags images as favorites.	p. 127
My Category	Categorizes images (Select, Select Range).	p. 128
i-Contrast	Corrects dark portions and contrast in still images.	p. 134
Red-Eye Correction	Corrects red eyes in still images.	p. 135
Trimming	Trims portions of still images.	p. 132
Resize	Resizes and saves still images.	p. 131
Scroll Display	On*/Off	p. 114
Auto Rotate	On*/Off	p. 161
Resume	Last seen*/Last shot	p. 161
Transition	 Fade*/Scroll/Slide/Off	p. 120
	 Fade*/Scroll/Slide/Off	
	 Fade*/Slide/Off	

* Default setting

Print Menu

Item	Content	Ref. Page
Print	Displays printing screen (When connected to a printer).	—
Select Images & Qty.	Chooses individual images for printing.	p. 146
Select Range	Chooses starting and ending images for printing.	p. 147
Select All Images	Chooses all images for printing.	p. 147
Clear All Selections	Cancel all settings for printing.	p. 147
Print Settings	Sets the printing style.	p. 145

Specifications

Image Sensor

Camera Effective Pixels	A3300 IS Approx. 16.0 million pixels
	A3200 IS A2200 ↓ Approx. 14.1 million pixels

Lens

Focal Length	A3300 IS A3200 IS
	5x zoom: 5.0 (W) – 25.0 (T) mm (35mm film equivalent : 28 (W) – 140 (T) mm)

A2200 ↓

4x zoom: 5.0 (W) – 20.0 (T) mm
(35mm film equivalent : 28 (W) – 112 (T) mm)

Focusing Range	A3300 IS A3200 IS
	3.0 cm (1.2 in.) – infinity (W), 90 cm (3.0 ft.) – infinity (T)

A2200 ↓

3.0 cm (1.2 in.) – infinity (W), 80 cm (2.6 ft.) – infinity (T)
• Macro 3.0 – 50 cm (W) (1.2 in. – 1.6 ft. (W))

Image Stabilizer System	Lens-shift type A3300 IS A3200 IS
-------------------------	---

Imaging Processor	DIGIC 4
-------------------	---------

LCD Monitor

Type	TFT color (wide viewing angle type)
------	-------------------------------------

Size	A3300 IS 3.0 type
------	--------------------------

A3200 IS **A2200** ↓ 2.7 type

Effective Pixels	Approx. 230,000 dots
------------------	----------------------

Aspect Ratio	4:3
--------------	-----

Features	Brightness adjustment (5 levels)
----------	----------------------------------

Focus

Control System	Autofocus: Single (Continuous in Auto mode), Continuous, Servo AF (Servo AE)
----------------	---

AF Frame	Face AiAF, Tracking AF, Center
----------	--------------------------------

Metering System	Evaluative, Center-weighted average, Spot
-----------------	---

Exposure Compensation (Still Images)/

Exposure Shift (Movies)	±2 stops in 1/3-stop increments
-------------------------	---------------------------------

ISO Speed (Standard Output Sensitivity,

Recommended Exposure Index)	Auto, ISO 80/100/200/400/800/1600
-----------------------------	-----------------------------------

White Balance	Auto, Day Light, Cloudy, Tungsten, Fluorescent, Fluorescent H, Custom
---------------	--

Shutter Speed	1 – 1/1600 sec.
---------------	-----------------

15 – 1/1600 sec. (Total shutter speed range)

Aperture

Type	Circular (Used together with ND filter)
f/number	A3300 IS A3200 IS f/2.8 / f/8.0 (W), f/5.9 / f/18 (T) A2200 f/2.8 / f/8.0 (W), f/5.9 / f/17 (T)

Flash

Modes	Auto, On, Slow Synchro, Off
Range	30 cm – 4.0 m (W), 50 cm – 2.0 m (T) (12 in. – 13 ft. (W), 1.6 – 6.6 ft. (T))

Shooting Modes..... P, Live View Control, Auto, Easy, SCN*¹, Creative Filters*², Discreet, Movie*³

*¹ Blur Reduction **A2200**, Portrait, Landscape, Kids&Pets, Smart Shutter*⁴, Low Light, Beach, Foliage, Snow, Fireworks, Long Shutter

*² Fish-eye Effect, Miniature Effect, Toy Camera Effect, Monochrome, Super Vivid, Poster Effect

*³ Standard, Miniature Effect

*⁴ Smile, Wink Self-timer, Face Self-timer

Digital Zoom Still images/Movies: Approx. 4.0x
(up to approx. 20x **A3300 IS** **A3200 IS**, 16x **A2200** in combination with the optical zoom)
Safety Zoom, Digital tele-converter

Continuous Shooting

Mode	Normal
Speed (Normal)	A3300 IS Approx. 0.8 shots/sec. (In P mode) Approx. 2.5 shots/sec. (In Low Light mode)
	A3200 IS Approx. 0.9 shots/sec. (In P mode) Approx. 2.8 shots/sec. (In Low Light mode)
	A2200 Approx. 0.9 shots/sec. (In P mode) Approx. 2.7 shots/sec. (In Low Light mode)

Number of Shots (Approximate)

(CIPA compliant)	A3300 IS Approx. 230 images
	A3200 IS Approx. 250 images
	A2200 Approx. 280 images

Recording Media SD memory card, SDHC memory card, SDXC memory card, MultiMediaCard, MMC*plus* card, HC MMC*plus* card

File Format Design rule for Camera File system, DPOF (Version 1.1) compliant

Specifications

Data Type

Still Images	Exif 2.3 (JPEG)
Movies.....	MOV (Image data: H.264; Audio data: Linear PCM (monaural))

Number of Recording Pixels

Still Images	A3300 IS Large: 4608 x 3456, Medium 1: 3264 x 2448, Medium 2: 1600 x 1200, Small: 640 x 480, Widescreen: 4608 x 2592 • Fixed to 2304 x 1728 when in Low Light mode
	A3200 IS A2200 Large: 4320 x 3240, Medium 1: 3072 x 2304, Medium 2: 1600 x 1200, Small: 640 x 480, Widescreen: 4320 x 2432 • Fixed to 2144 x 1608 when in Low Light mode
Movies.....	Standard: 1280 x 720 (30 fps*1), 640 x 480 (30fps*1), 320 x 240 (30 fps*1) Miniature Effect: 1280 x 720*2, 640 x 480*2 *1 Actual frame rate is 29.97 fps *2 Shooting: 6 fps, 3 fps, 1.5 fps Playback: 30 fps*1

Interface	Hi-Speed USB Analog audio output (monaural) Analog video output (NTSC/PAL)
-----------------	--

Direct Print Standard	PictBridge
-----------------------------	------------

Power Source.....	Battery Pack NB-8L AC Adapter Kit ACK-DC60
-------------------	---

Dimensions (CIPA compliant)	A3300 IS 95.1 x 56.7 x 23.9 mm (3.74 x 2.23 x 0.94 in.) A3200 IS 95.1 x 56.7 x 24.3 mm (3.74 x 2.23 x 0.96 in.) A2200 93.2 x 57.2 x 23.6 mm (3.67 x 2.25 x 0.93 in.)
-----------------------------------	---

Weight (CIPA compliant)	A3300 IS A3200 IS Approx. 149 g (5.25 oz.) (Including the battery and memory card) Approx. 130 g (4.60 oz.) (camera body only) A2200 Approx. 135 g (4.76 oz.) (Including the battery and memory card) Approx. 115 g (4.06 oz.) (camera body only)
-------------------------------	---

Battery Pack NB-8L

Type.....	Rechargeable lithium-ion battery
Voltage	3.6 V DC
Capacity.....	740 mAh
Charging Cycles	Approx. 300 times
Operating Temperature	0 – 40 °C (32 – 104 °F)
Dimensions.....	35.4 x 40.4 x 5.9 mm (1.39 x 1.59 x 0.23 in.)
Weight	Approx. 17 g (0.6 oz.)

Battery Charger CB-2LA/2LAE

Rated Input.....	100 – 240 V AC (50/60 Hz 12 VA), 0.1 A (100 V) – 0.07 A (240 V)
Rated Output.....	4.2 V DC, 0.65 A
Charge Time.....	Approx. 1 hour 30 min.
Operating Temperature	5 – 40 °C (41 – 104 °F)
Dimensions.....	56.0 x 81.0 x 25.0 mm (2.20 x 3.19 x 0.98 in.)
Weight	Approx. 65 g (2.29 oz.) (CB-2LA) Approx. 63 g (2.22 oz.) (CB-2LAE, excluding power cord)

- All data is based on tests by Canon.
- Camera specifications or appearance are subject to change without notice.

Numerics

3:2 Guide 159

A

AC Adapter Kit 164
Accessories 39
AE Lock 100, 109
AF Frames 25, 92
AF → Focus
AF Lock 96, 171
AF-Point Zoom 95
AUTO Mode (Shooting Mode) 24, 44
AV Cable 2, 120

B

Battery
Charge Indicator 15
Power Saving 54, 154, 155
Recharge 14
Beach (Shooting Mode) 69
Black and White Images 90
Blink Detection 103
Blur Reduction (Shooting Mode)
A2200 68

C

Camera
Default Settings 53
Holding the Camera 13
Camera Shake 26, 56, 160
Center (AF Frame Mode) 93
Clock Functions 54
Components Guide 42
Compression Ratio (Image Quality) 63
Continuous Shooting 89
Creative Filters (Shooting Mode) 72
Custom White Balance 86

D

Date and Time → Date/Time
Date/Time
Adding to Image 59
Changing 20
Setting 19

World Clock 155
Default Settings 53
DIGITAL CAMERA Solution Disk 2
Digital Tele-Converter 58
Digital Zoom 57
Discreet (Shooting Mode) 72
Display Language 21
DPOF 145
Drive Mode 89

E

Easy (Shooting/Playback Mode) 29
Editing
i-Contrast 134
Red-Eye Correction 135
Resizing (Making Images Smaller) ... 131
Trimming 132
Erasing All Images 125
Erasing Images 28, 125
Error Messages 169
Exposure
AE Lock 100, 109
Correction 85
FE Lock 100
Shift 109

F

Face AiAF (AF Frame Mode) 92
Face Select 98
Face Self-Timer (Shooting Mode) 80
Factory Settings → Default Settings
FE Lock 100, 171
File Numbering 153
Fireworks (Shooting Mode) 70
Fish-eye Effect (Shooting Mode) 73
Flash
Off 56
On 85
Slow Synchro 101
Focus
AF Frames 25, 92
AF Lock 96
AF-Point Zoom 95
Face Select 98

- Servo AF 97
 - Focus Check 117
 - Focus Lock 93
 - Focusing Range
 - Infinity 91
 - Macro 91
 - Foliage (Shooting Mode) 69
 - Format → Memory Cards, Formatting
 - Formatting (Memory Card) 22, 151
 - FUNC. Menu
 - Basic Operations 48
 - List 176
- G**
- Grid Lines 159, 171
- H**
- Household Power 164
- I**
- i-Contrast 88, 134
 - Image Quality → Compression Ratio
 - Images
 - Display Time 158
 - Editing → Editing
 - Erasing Images 28, 125
 - Playback → Viewing
 - Protect 122
 - Included Items → Accessories
 - Indicator 45, 47
 - Infinity (Focus Mode) 91
 - Interface Cable 2, 36, 138
 - ISO Speed 87, 171
- J**
- Jump Display 115
- K**
- Kids&Pets (Shooting Mode) 69
- L**
- Lamp 42, 43, 157
 - Landscape (Shooting Mode) 69
 - LCD Monitor → Screen
 - Live View Control (Shooting Mode) 71
 - Long Shutter (Shooting Mode) 81
 - Low Light (Shooting Mode) 69
- M**
- Macro (Focus Mode) 91
 - Magnified Display 118
 - Memory Cards
 - Available Shots 18, 64
 - Formatting 22, 151
 - Shooting Time 32
 - Menu
 - Basic Operations 49
 - List 184
 - Metering Method 99
 - Miniature Effect (Shooting Mode) 74, 106
 - Monochrome (Shooting Mode) 76
 - Movies
 - Editing 111
 - Image Quality (Recording Pixels/
Frame Rate) 108
 - Modes 106
 - Shooting Time 32
 - Viewing (Playback) 32
 - MultiMediaCard/MMC*plus* → Memory Cards
 - My Category 128
 - My Colors (Shooting) 90
- P**
- P (Shooting mode) 84
 - PictBridge 40, 138
 - Playback → Viewing
 - Playback With Transition Effects 120
 - Portrait (Shooting Mode) 68
 - Poster Effect (Shooting Mode) 73
 - Power → Batteries, Battery, AC Adapter Kit
 - Power Saving 54, 154, 155
 - Printing 138
 - Program AE (Shooting Mode) 84
 - Protect 122
- R**
- Recording Pixels (Image Size) 63
 - Red-Eye Correction 102, 135
 - Resizing (Making Images Smaller) 131
 - Rotate 130

S

Screen	
Display Language.....	21
Information Display.....	171, 173
Menu → FUNC. Menu, Menu	
Switching the Display	46
SD/SDHC/SDXC Memory Card → Memory Cards	
Self-Timer	
10 Second Self-Timer.....	60
Changing Delay and Number of Shots	62
Face Self-Timer (Shooting Mode)	80
Two Second Self-Timer	61
Wink Self-Timer (Shooting Mode)	78
Sepia Tones	90
Servo AF	97
Shooting	
Display Overlay	159
Number of Shots.....	15, 18, 64
Shooting Date and Time → Date/Time	
Shooting Info	171
Shooting Time	32
Shooting Using a TV	103
Slideshow	116
Smart Shuffle.....	119
Smart Shutter (Shooting Mode).....	77
Smile (Shooting Mode).....	77
Snow (Shooting Mode).....	70
Software	
DIGITAL CAMERA Solution Disk	2
Installation	35
Software Guide.....	2
Transferring Images to a Computer for Viewing.....	34
Sound Settings.....	50
Strap.....	13
Super Vivid (Shooting Mode)	73

T

Tag Images as Favorites.....	127
Terminal	36, 120, 138, 164
Toy Camera Effect (Shooting Mode).....	75
Tracking AF.....	26, 94
Travel Abroad.....	15, 39, 155

Trimming	132
Troubleshooting.....	165

V

Video → Movies	
Viewing	
Images on a TV	120
Index Display	114
Jump Display	115
Magnified Display	118
Scroll Display	114
Single Image Playback.....	27
Slideshow	116
Smart Shuffle.....	119
Viewing Images on a TV	120

W

White Balance	86
Wide (Recording Pixels).....	63, 64
Wink Self-Timer (Shooting Mode)	78
World Clock	155
Wrist Strap → Strap	

Z

Zoom	24, 30, 57
------------	------------

MEMO



MEMO

MEMO

Disclaimer

- Reprinting, transmitting, or storing in a retrieval system any part of this guide without the permission of Canon is prohibited.
- Canon reserves the right to change the contents of this guide at any time without prior notice.
- Illustrations and screenshots in this guide may differ slightly from the actual equipment.
- The above items notwithstanding, Canon accepts no liability for damages due to mistaken operation of the products.