

# ***Nikon***

DIGITAL CAMERA

# COOLPIX L26 L25

## Reference Manual



En

### **Trademark Information**

- Microsoft, Windows and Windows Vista are either registered trademarks or trademarks of Microsoft Corporation in the United States and/or other countries.
- Macintosh, Mac OS, and QuickTime are trademarks of Apple Inc., registered in the U.S. and other countries.
- Adobe and Acrobat are registered trademarks of Adobe Systems Inc.
- SDXC, SDHC and SD Logos are trademarks of SD-3C, LLC.
- PictBridge is a trademark.
- All other trade names mentioned in this manual or the other documentation provided with your Nikon product are trademarks or registered trademarks of their respective holders.

**Introduction**

**Parts of the Camera**

**The Basics of Shooting and Playback**

**Shooting Features**

**Playback Features**

**Recording and Playing Back Movies**

**General Camera Setup**

**Reference Section**

**Technical Notes and Index**

# Read This First

Thank you for purchasing the Nikon COOLPIX L26 or COOLPIX L25 digital camera. Before using the camera, please read the information in “For Your Safety” (📖 viii) and familiarize yourself with the information provided in this manual. After reading, please keep this manual handy and refer to it to enhance your enjoyment of your new camera.

## Confirming the Package Contents

In the event that any items are missing, please contact the store where you purchased the camera.



COOLPIX L26  
Digital Camera

OR



COOLPIX L25  
Digital Camera



Camera Strap

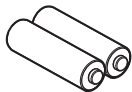

LR6/L40 (AA-size)  
alkaline batteries (x2)\*



USB Cable UC-E16



ViewNX 2 Installer CD



Reference Manual CD

- Warranty

- \* The included batteries are for trial use only.
- A memory card is not included with the camera.

## Attaching the Camera Strap

COOLPIX L26

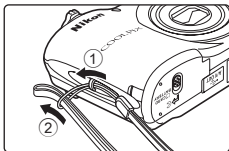

COOLPIX L25

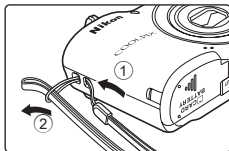

## About This Manual





If you want to start using the camera right away, see “The Basics of Shooting and Playback” (📖 9).

To learn about the parts of the camera and information that is displayed in the monitor, see “Parts of the Camera” (📖 1).

## Other Information

- Symbols and Conventions

To make it easier to find the information you need, the following symbols and conventions are used in this manual:

Icon	Description
	This icon indicates cautions and information that should be read before using the camera.
	This icon indicates notes and information that should be read before using the camera.
	These icons indicate other pages containing relevant information;  : "Reference Section",  : "Technical Notes and Index."

- In this manual, the product names "COOLPIX L26" and "COOLPIX L25" may sometimes be abbreviated as "L26" and "L25."
- SD, SDHC, and SDXC memory cards are referred to as "memory cards" in this manual.
- The setting at the time of purchase is referred to as the "default setting."
- The names of menu items displayed in the camera monitor, and the names of buttons or messages displayed on a computer monitor appear in bold.
- In this manual, images are sometimes omitted from monitor display samples so that monitor indicators can be more clearly shown.
- Illustrations and text displays shown in this manual are for COOLPIX L26. Illustrations and text displays for COOLPIX L25 may also be shown in this manual if necessary.
- Illustrations and monitor content shown in this manual may differ from the actual product.

## Information and Precautions

### Life-Long Learning

As part of Nikon's "Life-Long Learning" commitment to ongoing product support and education, continually updated information is available online at the following sites:

- For users in the U.S.A.: <http://www.nikonusa.com/>
- For users in Europe and Africa: <http://www.europe-nikon.com/support/>
- For users in Asia, Oceania, and the Middle East: <http://www.nikon-asia.com/>

Visit these sites to keep up-to-date with the latest product information, tips, answers to frequently asked questions (FAQs), and general advice on digital imaging and photography. Additional information may be available from the Nikon representative in your area. Visit the site below for contact information:

<http://imaging.nikon.com/>

### Use Only Nikon Brand Electronic Accessories

Nikon COOLPIX cameras are designed to the highest standards and include complex electronic circuitry. Only Nikon brand electronic accessories (including battery chargers, batteries, and AC adapters) certified by Nikon specifically for use with this Nikon digital camera are engineered and proven to operate within the operational and safety requirements of this electronic circuitry.

THE USE OF NON-NIKON ELECTRONIC ACCESSORIES COULD DAMAGE THE CAMERA AND MAY VOID YOUR NIKON WARRANTY.

For more information about Nikon brand accessories, contact a local authorized Nikon dealer.

### Before Taking Important Pictures

Before taking pictures on important occasions (such as at weddings or before taking the camera on a trip), take a test shot to ensure that the camera is functioning normally. Nikon will not be held liable for damages or lost profits that may result from product malfunction.

## About the Manuals

- No part of the manuals included with this product may be reproduced, transmitted, transcribed, stored in a retrieval system, or translated into any language in any form, by any means, without Nikon's prior written permission.
- Nikon reserves the right to change the specifications of the hardware and software described in these manuals at any time and without prior notice.
- Nikon will not be held liable for any damages resulting from the use of this product.
- While every effort was made to ensure that the information in these manuals is accurate and complete, we would appreciate it were you to bring any errors or omissions to the attention of a Nikon representative in your area (address provided separately).

## Notice Concerning Prohibition of Copying or Reproduction

Note that simply being in possession of material that was digitally copied or reproduced by means of a scanner, digital camera or other device may be punishable by law.

### • **Items prohibited by law from being copied or reproduced**

Do not copy or reproduce paper money, coins, securities, government bonds or local government bonds, even if such copies or reproductions are stamped "Sample." The copying or reproduction of paper money, coins, or securities which are circulated in a foreign country is prohibited. Unless the prior permission of the government was obtained, the copying or reproduction of unused postage stamps or post cards issued by the government is prohibited.

The copying or reproduction of stamps issued by the government and of certified documents stipulated by law is prohibited.

### • **Cautions on certain copies and reproductions**

The government has issued cautions on copies or reproductions of securities issued by private companies (shares, bills, checks, gift certificates, etc.), commuter passes, or coupon tickets, except when a minimum of necessary copies are to be provided for business use by a company. Also, do not copy or reproduce passports issued by the government, licenses issued by public agencies and private groups, ID cards and tickets, such as passes and meal coupons.



- **Comply with copyright notices**

The copying or reproduction of copyrighted creative works such as books, music, paintings, woodcut prints, maps, drawings, movies, and photographs is governed by national and international copyright laws. Do not use this product for the purpose of making illegal copies or to infringe copyright laws.

## **Disposing of Data Storage Devices**

Please note that deleting images or formatting data storage devices such as memory cards or built-in camera memory does not completely erase the original image data. Deleted files can sometimes be recovered from discarded storage devices using commercially available software, potentially resulting in the malicious use of personal image data. Ensuring the privacy of such data is the user's responsibility.

Before discarding a data storage device or transferring ownership to another person, erase all data using commercial deletion software, or format the device and then completely refill it with images containing no private information (for example, pictures of empty sky). Be sure to also replace any pictures selected for the **Select an image** option in the **Welcome screen** setting (📖 86). Care should be taken to avoid injury or damage to property when physically destroying data storage devices.

# For Your Safety

To prevent damage to your Nikon product or injury to yourself or to others, read the following safety precautions in their entirety before using this equipment. Keep these safety instructions where all those who use the product will read them.



This icon marks warnings, information that should be read before using this Nikon product, to prevent possible injury.

## WARNINGS

### **Turn off in the event of malfunction**

Should you notice smoke or an unusual smell coming from the camera or AC adapter, unplug the AC adapter and remove the batteries immediately, taking care to avoid burns. Continued operation could result in injury. After removing or disconnecting the power source, take the equipment to a Nikon-authorized service representative for inspection.

### **Do not disassemble**

Touching the internal parts of the camera or AC adapter could result in injury. Repairs should be performed only by qualified technicians. Should

the camera or AC adapter break open as the result of a fall or other accident, take the product to a Nikon-authorized service representative for inspection, after unplugging the product and/or removing the batteries.

### **Do not use the camera or AC adapter in the presence of flammable gas**

Do not use electronic equipment in the presence of flammable gas, as this could result in explosion or fire.

### **Handle the camera strap with care**

Never place the strap around the neck of an infant or child.

** Keep out of reach of children**

Particular care should be taken to prevent infants from putting the battery or other small parts into their mouths.

** Do not remain in contact with the camera, battery charger, or AC adapter for extended periods while the devices are on or in use**

Parts of the devices become hot. Leaving the devices in direct contact with the skin for extended periods may result in low-temperature burns.

** Observe caution when handling batteries**

Batteries may leak or explode if improperly handled. Observe the following precautions when handling batteries for use in this product:

- Before replacing the batteries, turn the product off. If you are using an AC adapter, be sure it is unplugged.
- Use only the batteries approved for use in this product ( 10). Do not combine old and new batteries or batteries of different makes or types.
- If Nikon rechargeable Ni-MH batteries EN-MH2 (EN-MH2-B2 or EN-MH2-B4) are purchased separately, charge and use each of them as a set. Do not combine batteries from different pairs.
- The EN-MH2 rechargeable batteries are for use with Nikon digital cameras only, and are compatible with COOLPIX L26/L25.
- Insert batteries in the correct orientation.
- Do not short or disassemble batteries or attempt to remove or break battery insulation or casing.
- Do not expose batteries to flame or to excessive heat.
- Do not immerse in or expose to water.
- Do not transport or store with metal objects such as necklaces or hairpins.

- Batteries are prone to leakage when fully discharged. To avoid damage to the product, be sure to remove the batteries when no charge remains.
- Discontinue use immediately should you notice any change in the batteries, such as discoloration or deformation.
- If liquid from damaged batteries comes in contact with clothing or skin, rinse immediately with plenty of water.

** Observe the following precautions when handling the Battery Chargers (available separately)**

- Keep dry. Failure to observe this precaution could result in fire or electric shock.
- Dust on or near the metal parts of the plug should be removed with a dry cloth. Continued use could result in fire.
- Do not handle the power cable or go near the battery charger during lightning storms. Failure to observe this precaution could result in electric shock.
- Do not damage, modify, forcibly tug or bend the power cable, place it under heavy objects, or expose it to heat or flame. Should the insulation be damaged and the wires become exposed, take it to a Nikon-authorized service representative for inspection. Failure to observe these precautions could result in fire or electric shock.
- Do not handle the plug or battery charger with wet hands. Failure to observe this precaution could result in electric shock.
- Do not use with travel converters or adapters designed to convert from one voltage to another or with DC-to-AC inverters. Failure to observe this precaution could damage the product or result in overheating or fire.

 **Use appropriate cables**

When connecting cables to the input and output jacks, use only the cables provided or sold by Nikon for the purpose, to maintain compliance with product regulations.

 **Handle moving parts with care**

Be careful that your fingers or other objects are not pinched by the lens cover or other moving parts.

 **CD-ROMs**

The CD-ROMs included with this device should not be played back on audio CD equipment. Playing CD-ROMs on an audio CD player could cause hearing loss or damage the equipment.

 **Observe caution when using the flash**

Using the flash close to your subject's eyes could cause temporary visual impairment. Particular care should be observed if photographing infants, when the flash should be no less than 1 m (3 ft 4 in.) from the subject.

 **Do not operate the flash with the flash window touching a person or object**

Failure to observe this precaution could result in burns or fire.

 **Avoid contact with liquid crystal**

Should the monitor break, care should be taken to avoid injury caused by broken glass and to prevent liquid crystal from the monitor touching the skin or entering the eyes or mouth.

 **Turn the power off when using inside an airplane or the hospital**

Turn the power off while inside the airplane during take off or landing. Follow the instructions of the hospital when using while in a hospital. The electromagnetic waves given out by this camera may disrupt the electronic systems of the airplane or the instruments of the hospital.

# Notices

## **Notice for Customers in the U.S.A.**

### **Federal Communications Commission (FCC) Radio Frequency Interference Statement**

This equipment has been tested and found to comply with the limits for a Class B digital device, pursuant to Part 15 of the FCC rules. These limits are designed to provide reasonable protection against harmful interference in a residential installation. This equipment generates, uses, and can radiate radio frequency energy and, if not installed and used in accordance with the instructions, may cause harmful interference to radio communications. However, there is no guarantee that interference will not occur in a particular installation. If this equipment does cause harmful interference to radio or television reception, which can be determined by turning the equipment off and on, the user is encouraged to try to correct the interference by one or more of the following measures:

- Reorient or relocate the receiving antenna.
- Increase the separation between the equipment and receiver.
- Connect the equipment into an outlet on a circuit different from that to which the receiver is connected.
- Consult the dealer or an experienced radio/television technician for help.



**Nikon**

COOLPIX L26  
COOLPIX L25

## **CAUTIONS**

### **Modifications**

The FCC requires the user to be notified that any changes or modifications made to this device that are not expressly approved by Nikon Corporation may void the user's authority to operate the equipment.

## **Interface Cables**

Use the interface cables sold or provided by Nikon for your equipment. Using other interface cables may exceed the limits of Class B Part 15 of the FCC rules.

## **Notice for customers in the State of California**

### **WARNING**

Handling the cord on this product will expose you to lead, a chemical known to the State of California to cause birth defects or other reproductive harm.

### ***Wash hands after handling.***

Nikon Inc.,  
1300 Walt Whitman Road Melville,  
New York 11747-3064 USA  
Tel: 631-547-4200

## **Notice for customers in Canada**

### **CAUTION**

This Class B digital apparatus complies with Canadian ICES-003.

### **ATTENTION**

Cet appareil numérique de la classe B est conforme à la norme NMB-003 du Canada.

## **Symbol for Separate Collection in European Countries**

This symbol indicates that this product is to be collected separately.

The following apply only to users in European countries:

- This product is designated for separate collection at an appropriate collection point. Do not dispose of as household waste.
- For more information, contact the retailer or the local authorities in charge of waste management.



This symbol on the battery indicates that the battery is to be collected separately.

The following apply only to users in European countries:



























- All batteries, whether marked with this symbol or not, are designated for separate collection at an appropriate collection point. Do not dispose of as household waste.
- For more information, contact the retailer or the local authorities in charge of waste management.





# Table of Contents

Introduction .....	ii	Step 3 Focus and Shoot .....	26
Read This First .....	ii	The Shutter-release Button .....	27
Confirming the Package Contents .....	iii	Step 4 Play Back Images .....	29
Attaching the Camera Strap .....	iii	Step 5 Delete Images .....	31
About This Manual .....	iii		
Information and Precautions .....	v	<b>Shooting Features .....</b>	<b>33</b>
For Your Safety .....	viii	📷 (Easy Auto) Mode .....	34
WARNINGS .....	viii	Changing 📷 (Easy Auto) Mode Settings ...	34
Notices .....	xii	Scene Mode (Shooting Suited to Scenes) ...	35
		Changing Scene Mode Settings .....	36
		Characteristics of Each Scene .....	36
<b>Parts of the Camera .....</b>	<b>1</b>	Smart Portrait Mode (Capturing Smiling	
The Camera Body .....	2	Faces) .....	43
The Monitor .....	6	Changing Smart Portrait Mode Settings ..	44
Shooting Mode .....	6	Options Available in the Smart Portrait	
Playback Mode .....	8	Menu .....	45
		Using Skin Softening .....	46
<b>The Basics of Shooting and Playback ....</b>	<b>9</b>	📷 (Auto) Mode .....	47
Preparation 1 Insert the Batteries .....	10	Changing 📷 (Auto) Mode Settings .....	47
Applicable Batteries .....	10	Options Available in the Auto Shooting	
Preparation 2 Insert a Memory Card .....	13	Menu .....	48
Internal Memory and Memory Cards .....	14	<b>Features That Can Be Set Using the Multi</b>	
Approved Memory Cards .....	15	<b>Selector .....</b>	<b>49</b>
Preparation 3 Set the Display Language,		Available Features .....	49
Date, and Time .....	16	Using the Flash (Flash Modes) .....	50
Step 1 Turn the Camera On and Select		Using the Self-timer .....	53
Shooting Mode .....	20	Using Macro Mode .....	55
Turning the Camera On and Off .....	21	Adjusting Brightness (Exposure	
Step 2 Frame a Picture .....	23	Compensation) .....	57
Using the Zoom .....	24	Default Settings .....	58

Changing the Image Size (Image Mode)....	60
Image Mode Settings (Image Size and Quality) .....	60
Features That Cannot Be Used	
Simultaneously .....	62
Focusing .....	63
Using Face Detection .....	63
Focus Lock .....	64
<hr/>	
Playback Features.....	65
Playback Zoom .....	66
Thumbnail Display, Calendar Display .....	67
Features Available in Playback Mode (Playback Menu) .....	68
Connecting the Camera to a TV, Computer, or Printer .....	69
Using ViewNX 2 .....	71
Installing ViewNX 2 .....	71
Transferring Images to the Computer .....	74
Viewing Images .....	76
<hr/>	
Recording and Playing Back Movies....	77
Recording Movies .....	78
Changing Movie Recording Settings (the Movie Menu) .....	81
Playing Back Movies .....	82
<hr/>	
General Camera Setup.....	85
The Setup Menu .....	86
<hr/>	
Reference Section .....	 1
Using Panorama Assist.....	 2
Editing Still Images.....	 5
Editing Features.....	 5
 D-Lighting: Enhancing Brightness and Contrast .....	 7
 Skin Softening: Softening Skin Tones...	 8
 Small Picture: Reducing the Size of an Image.....	 9
 Crop: Creating a Cropped Copy ....	 10
Connecting the Camera to a TV (Viewing Images on a TV).....	 12
Connecting the Camera to a Printer (Direct Print).....	 14
Connecting the Camera to a Printer...	 15
Printing Individual Images .....	 17
Printing Multiple Images .....	 19
The Smart Portrait Menu .....	 22
Skin Softening.....	 22
Smile Timer.....	 23
Blink Proof .....	 23
The Shooting Menu (for  (Auto) Mode).....	 24
White Balance (Adjusting Hue).....	 24
Continuous Shooting .....	 27
Color Options.....	 28

<b>The Playback Menu</b> .....	029	<b>File and Folder Names</b> .....	063
Print Order (Creating a DPOF Print Order).....	029	<b>Optional Accessories</b> .....	064
Slide Show .....	032	<b>Error Messages</b> .....	065
Protect.....	033		
Rotate Image .....	035		
Copy (Copy Between Internal Memory and Memory Card) .....	036		
<b>The Movie Menu</b> .....	038		
Movie Options.....	038		
Autofocus Mode (L26 Only).....	039		
<b>The Setup Menu</b> .....	040		
Welcome Screen.....	040		
Time Zone and Date .....	041		
Monitor Settings .....	045		
Print Date (Imprinting Date and Time)...	047		
Electronic VR .....	048		
Motion Detection.....	050		
AF Assist (L26 Only).....	051		
Sound Settings .....	052		
Auto Off.....	053		
Format Memory/Format Card.....	054		
Language .....	055		
Video Mode .....	055		
Blink Warning.....	056		
Eye-Fi Upload.....	058		
Reset All.....	059		
Battery Type.....	062		
Firmware Version.....	062		

Technical Notes and Index.....	🔍:1
Caring for the Product .....	🔍:2
The Camera.....	🔍:2
Batteries.....	🔍:4
Memory Cards.....	🔍:6
Cleaning and Storage.....	🔍:7
Cleaning.....	🔍:7
Storage .....	🔍:7
Troubleshooting .....	🔍:8
Specifications .....	🔍:15
Supported Standards.....	🔍:20
Index.....	🔍:21



# Parts of the Camera

---

This chapter describes the parts of the camera and explains information that is displayed in the monitor.

<b>The Camera Body</b> .....	<b>2</b>
<b>The Monitor</b> .....	<b>6</b>
Shooting Mode .....	6
Playback Mode .....	8

➔ If you want to start using the camera right away, see “The Basics of Shooting and Playback” (📖 9).

## The Camera Body

## COOLPIX L26

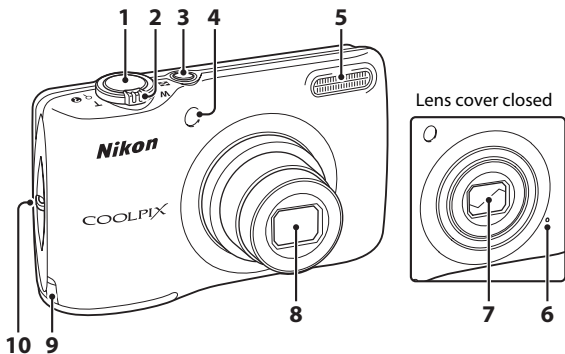

<b>1</b>	Shutter-release button.....	26
<b>2</b>	Zoom control.....	24
	<b>W</b> : wide.....	24
	<b>T</b> : tele.....	24
	: thumbnail playback.....	67
	: playback zoom.....	66
: help.....	35	
<b>3</b>	Power switch/power-on lamp.....	20
<b>4</b>	Self-timer lamp.....	53
	AF-assist illuminator.....	86

<b>5</b>	Flash.....	50
<b>6</b>	Microphone.....	78
<b>7</b>	Lens cover	
<b>8</b>	Lens	
<b>9</b>	Power connector cover (for connecting optional AC adapter).....	64
<b>10</b>	Eyelet for camera strap.....	iii

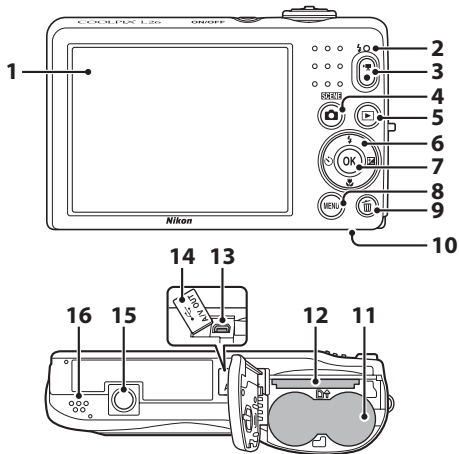

<b>1</b>	Monitor .....	6
<b>2</b>	Flash lamp.....	50
<b>3</b>	● (▶ movie-record) button.....	78
<b>4</b>	📷 (shooting mode) button...34, 35, 43, 47	
<b>5</b>	▶ (playback) button.....	29
<b>6</b>	Multi selector	
<b>7</b>	OK (apply selection) button	
<b>8</b>	MENU button.....	45, 48, 68, 81, 86
<b>9</b>	🗑 (delete) button.....	31

<b>10</b>	Battery-chamber/ memory card slot cover.....	10, 13
<b>11</b>	Battery chamber.....	10
<b>12</b>	Memory card slot.....	13
<b>13</b>	USB/audio/video output connector.....	69
<b>14</b>	Connector cover.....	69
<b>15</b>	Tripod socket.....	18
<b>16</b>	Speaker.....	82

# COOLPIX L25

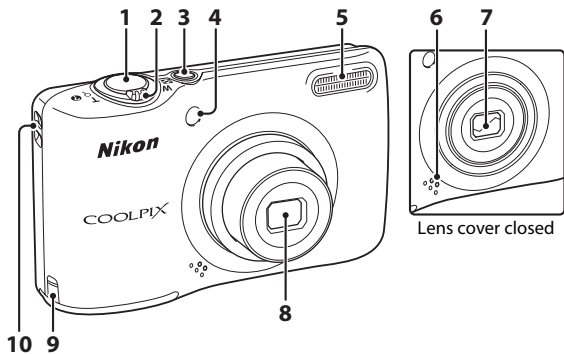

<b>1</b>	Shutter-release button.....	26
<b>2</b>	Zoom control.....	24
	<b>W</b> : wide.....	24
	<b>T</b> : tele.....	24
	: thumbnail playback.....	67
	: playback zoom.....	66
: help.....	35	
<b>3</b>	Power switch/power-on lamp.....	20
<b>4</b>	Self-timer lamp.....	53
<b>5</b>	Flash.....	50
<b>6</b>	Microphone.....	78
<b>7</b>	Lens cover	
<b>8</b>	Lens	
<b>9</b>	Power connector cover (for connecting optional AC adapter).....	64
<b>10</b>	Eyelet for camera strap.....	iii



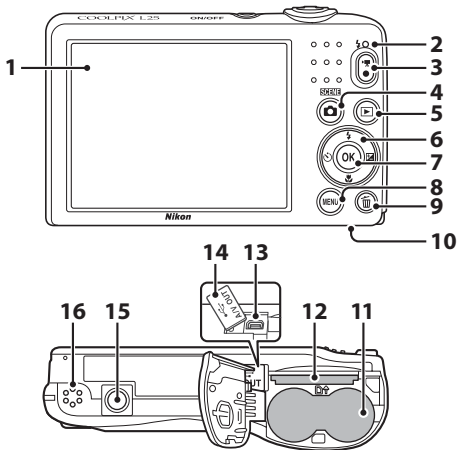

<b>1</b>	Monitor .....	6
<b>2</b>	Flash lamp.....	50
<b>3</b>	● (movie-record) button.....	78
<b>4</b>	📷 (shooting mode) button...34, 35, 43, 47	
<b>5</b>	▶ (playback) button.....	29
<b>6</b>	Multi selector	
<b>7</b>	OK (apply selection) button	
<b>8</b>	MENU button.....	45, 48, 68, 81, 86
<b>9</b>	🗑️ (delete) button.....	31



<b>10</b>	Battery-chamber/ memory card slot cover.....	10, 13
<b>11</b>	Battery chamber.....	10
<b>12</b>	Memory card slot.....	13
<b>13</b>	USB/audio/video output connector.....	69
<b>14</b>	Connector cover.....	69
<b>15</b>	Tripod socket.....	18
<b>16</b>	Speaker.....	82

# The Monitor

- The information that is displayed in the monitor during shooting and playback changes depending on the camera's settings and state of use. By default, information is displayed when the camera is turned on and when you operate the camera, and turns off after a few seconds (**Monitor settings** (📖 86) > **Photo info** > **Auto info**).

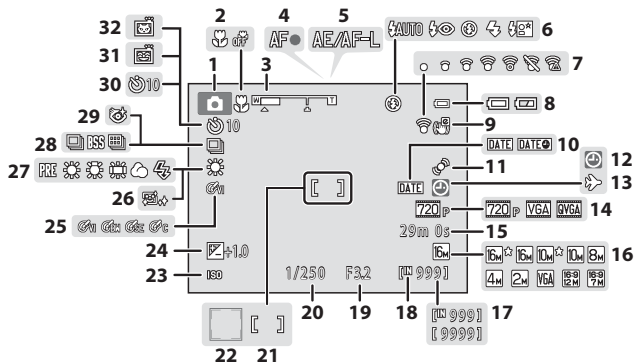
## Shooting Mode



<b>1</b>	Shooting mode.....	34, 35, 43, 47	<b>18</b>	Internal memory indicator .....	21
<b>2</b>	Macro mode .....	55	<b>19</b>	Aperture value .....	27
<b>3</b>	Zoom indicator .....	24, 55	<b>20</b>	Shutter speed.....	27
<b>4</b>	Focus indicator.....	26	<b>21</b>	Focus area.....	23, 26
<b>5</b>	AE/AF-L indicator.....	 4	<b>22</b>	Focus area (face detection, pet detection) .....	23, 26
<b>6</b>	Flash mode.....	50	<b>23</b>	ISO sensitivity.....	 12
<b>7</b>	Eye-Fi indicator .....	87	<b>24</b>	Exposure compensation value .....	57
<b>8</b>	Battery level indicator .....	21	<b>25</b>	Color options.....	48
<b>9</b>	Electronic VR icon.....	86	<b>26</b>	Skin softening.....	45
<b>10</b>	Print date .....	86	<b>27</b>	White balance mode .....	48
<b>11</b>	Motion detection icon .....	86	<b>28</b>	Continuous shooting mode .....	48
<b>12</b>	“Date not set” indicator.....	19, 86,  65	<b>29</b>	Blink proof icon .....	45
<b>13</b>	Travel destination icon.....	86	<b>30</b>	Self-timer indicator .....	53
<b>14</b>	Movie options.....	81	<b>31</b>	Smile timer .....	45
<b>15</b>	Movie length.....	80	<b>32</b>	Pet portrait auto release .....	42
<b>16</b>	Image mode*.....	60			
<b>17</b>	Number of exposures remaining (still images).....	21			

\* , , and  are displayed on L26, , , and  are displayed on L25.

# Playback Mode

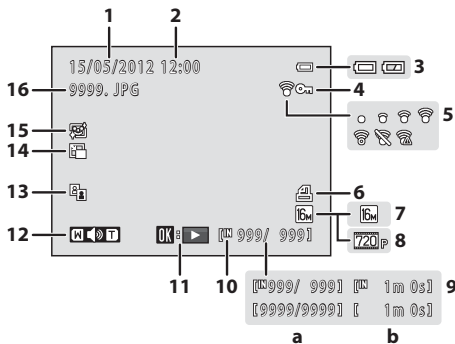

<b>1</b>	Date of recording .....	16	<b>10</b>	Internal memory indicator .....	29
<b>2</b>	Time of recording .....	16	<b>11</b>	Movie playback indicator .....	82
<b>3</b>	Battery level indicator .....	21	<b>12</b>	Volume indicator .....	83
<b>4</b>	Protect icon .....	68	<b>13</b>	D-Lighting icon .....	68
<b>5</b>	Eye-Fi indicator .....	87	<b>14</b>	Small picture icon .....	68
<b>6</b>	Print order icon .....	68	<b>15</b>	Skin softening icon .....	68
<b>7</b>	Image mode* .....	60	<b>16</b>	File number and type .....	63
<b>8</b>	Movie options .....	81			
<b>9</b>	(a) Current image number/ total number of images .....	29			
	(b) Movie length .....	82			

\* , , and are displayed on L26, , , and are displayed on L25.



# The Basics of Shooting and Playback

---

## Preparation

Preparation 1 Insert the Batteries .....	10
Preparation 2 Insert a Memory Card .....	13
Preparation 3 Set the Display Language, Date, and Time.....	16



## Shooting

Step 1 Turn the Camera On and Select Shooting Mode.....	20
Step 2 Frame a Picture .....	23
Step 3 Focus and Shoot .....	26



## Playback

Step 4 Play Back Images .....	29
Step 5 Delete Images.....	31

## Preparation 1 Insert the Batteries

### 1 Open the battery-chamber/ memory card slot cover.

- Before opening the battery-chamber/  
memory card slot cover, hold the  
camera upside down to prevent the  
batteries from falling out.

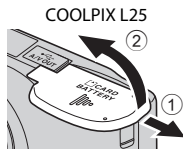
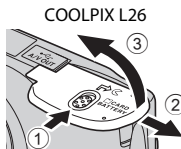

### 2 Insert the batteries.

- Confirm that the positive (+) and negative (-) terminals are  
oriented correctly as described on the label at the entrance  
of the battery chamber, and insert the batteries.

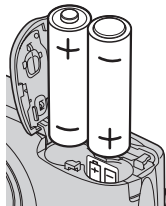

### 3 Close the battery-chamber/ memory card slot cover.

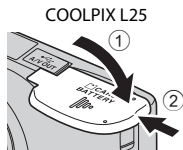
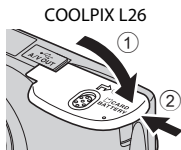

## Applicable Batteries

- Two LR6/L40 (AA-size) alkaline batteries (batteries included)
- Two FR6/L91 (AA-size) lithium batteries
- Two EN-MH2 Ni-MH (nickel metal hydride) rechargeable batteries

## ✓ Removing the Batteries

- Turn the camera off and be sure that the power-on lamp and the monitor have turned off before opening the battery-chamber/memory card slot cover.
- The camera, batteries, or memory card may be hot immediately after using the camera. Observe caution when removing the batteries or memory card.

## ✓ Notes About the Batteries

- Be sure to read and follow the warnings for the battery on page ix and in "Batteries" (🔧:4) before use.
- Do not combine old and new batteries or batteries of different makes or types.
- Batteries with the following defects cannot be used:

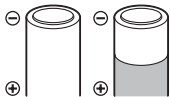

Batteries with peeling



Batteries with insulation that does not cover the area around the negative terminal

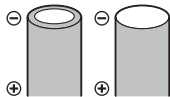

Batteries with a flat negative terminal

## ✓ Battery Type

By setting **Battery type** in the setup menu (📖 86) to match the type of batteries inserted in the camera, the batteries can perform more efficiently.

The default setting is the type of battery included with purchase. When any other type of battery is used, turn the camera on and change the setting.

## 📎 Alkaline Batteries

Performance of alkaline batteries may vary greatly depending on the manufacturer. Choose a reliable brand.

## **Notes About an AC Power Source**

- You can use the AC Adapter EH-65A (available separately;  64) to supply power to the camera from an electrical outlet.
- Do not, under any circumstances, use another make or model of AC adapter other than the EH-65A. Failure to observe this precaution could result in overheating or in damage to the camera.



## Preparation 2 Insert a Memory Card

- 1** Turn off the camera and open the battery-chamber/memory card slot cover.

- When the camera turns off, the power-on lamp and the monitor turn off.
- Before opening the battery-chamber/memory card slot cover, hold the camera upside down to prevent the batteries from falling out.

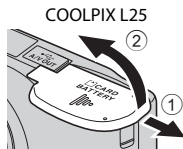
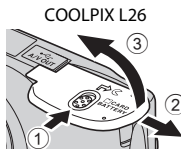

- 2** Insert a memory card.

- Slide the memory card in until it clicks into place.

**✓** **Inserting a Memory Card**

**Inserting a memory card upside down or backwards could damage the camera and the memory card.** Be sure to check that the memory card is in the correct orientation.

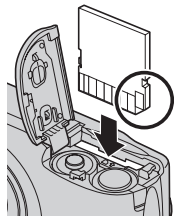

- 3** Close the battery-chamber/memory card slot cover.

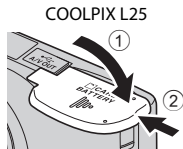
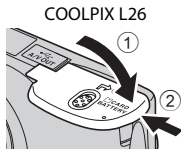

## ✓ Formatting a Memory Card

- The first time you insert a memory card that has been used in another device into this camera, be sure to format it with this camera.
- **All data stored on a memory card is permanently deleted when the card is formatted.** Copy any data on the card that you wish to keep to a computer before formatting.
- To format a memory card, insert the card into the camera, press the **MENU** button, and select **Format card** (🔑 54) in the setup menu (📖 86).

## ✓ Notes About Memory Cards

See “Memory Cards” (🔑 6) and the documentation included with your memory card for more information.

## Removing the Memory Card

- Turn the camera off and be sure that the power-on lamp and the monitor have turned off before opening the battery-chamber/memory card slot cover. Gently push the memory card into the camera (①) to partially eject the card, and then remove the card (②). Do not pull it at an angle.
- The camera, battery, and memory card may be hot immediately after using the camera. Observe caution when removing the battery or memory card.

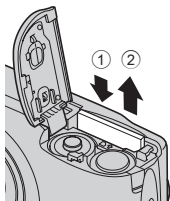

## Internal Memory and Memory Cards

Camera data, including images and movies, can be saved in either the camera's internal memory (approximately 20 MB) or on a memory card. To use the camera's internal memory for shooting or playback, first remove the memory card.

## Approved Memory Cards

The following Secure Digital (SD) memory cards have been tested and approved for use in this camera.

- Memory cards with an SD Speed Class rating of 6 or faster are recommended for recording movies. When using a memory card with a lower Speed Class rating, movie recording may stop unexpectedly.

	SD memory card	SDHC memory card <sup>2</sup>	SDXC memory card <sup>3</sup>
SanDisk	2 GB <sup>1</sup>	4 GB, 8 GB, 16 GB, 32 GB	64 GB
TOSHIBA	2 GB <sup>1</sup>	4 GB, 8 GB, 16 GB, 32 GB	64 GB
Panasonic	2 GB <sup>1</sup>	4 GB, 8 GB, 12 GB, 16 GB, 32 GB	48 GB, 64 GB
Lexar	–	4 GB, 8 GB, 16 GB, 32 GB	64 GB, 128 GB

<sup>1</sup> If the memory card will be used with a card reader or similar device, make sure that the device supports 2 GB cards.

<sup>2</sup> SDHC compliant.

If the memory card will be used with a card reader or similar device, make sure that the device supports SDHC.

<sup>3</sup> SDXC compliant.

If the memory card will be used with a card reader or similar device, make sure that the device supports SDXC.

- Contact the manufacturer for details on the above cards. We cannot guarantee camera performance when using memory cards made by other manufacturers.



## Preparation 3 Set the Display Language, Date, and Time

When the camera is turned on for the first time, the language-selection screen and the date and time setting screen for the camera clock are displayed.

### 1 Press the power switch to turn on the camera.

- When the camera is turned on, the power-on lamp (green) will light and then the monitor will turn on (the power-on lamp turns off when the monitor turns on).

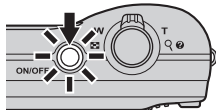

### 2 Press the multi selector ▲ or ▼ to select the desired language and press the **OK** button.

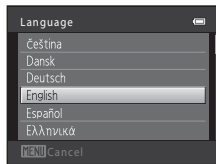

### 3 Press ▲ or ▼ to select **Yes** and press the **OK** button.

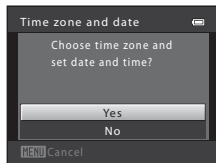

**4** Press ◀ or ▶ to select your home time zone and press the **OK** button.

- Press ▲ to enable daylight saving time. When the daylight saving time function is enabled, ☀ is displayed at the top of the monitor. Press ▼ to disable daylight saving time.

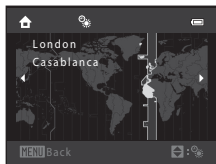

**5** Press ▲ or ▼ to select the date format and press the **OK** button.

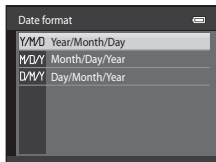

**6** Press ▲, ▼, ◀, or ▶ to set the date and time, and press the **OK** button.

- Select an item: Press ▶ or ◀ (changes between **D**, **M**, **Y**, **hour**, and **minute**).
- Edit the date and time: Press ▲ or ▼.
- Confirm the setting: Select the **minute** setting and press the **OK** button.

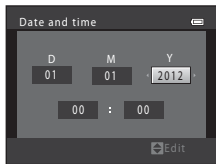

**7** Press ▲ or ▼ to select **Yes** and press the **OK** button.

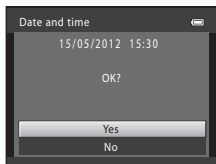

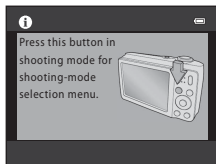

## 8 Press the button.

- The lens extends and the shooting-mode selection screen is displayed.



## 9 When **Easy auto mode** is displayed, press the button.

- The camera enters the shooting mode and you can take pictures in Easy auto mode (📖 20).
- Press the multi selector  or  before pressing the  button, to switch to another shooting mode.

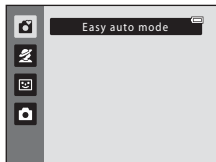

## Changing the Language Setting and the Date and Time Setting

- You can change these settings using the **Language** (🔍55) and **Time zone and date** (🔍41) settings in the **Y** setup menu (📖 86).
- You can enable and disable daylight saving time by selecting the **Y** setup menu > **Time zone and date** (🔍41) > **Time zone**. When enabled, the clock moves forward one hour; when disabled, the clock moves back one hour. When the travel destination (👉) is selected, the time difference between the travel destination and the home time zone (🏠) is automatically calculated and the date and time in the selected region are saved at the time of shooting.
- If you exit without setting the date and time, ⏰ will flash when the shooting screen is displayed. Use the **Time zone and date** setting in the setup menu to set the date and time (📖 86, 🔍41).

## The Clock Battery

- The camera's clock is powered by a backup battery that is separate from the camera's main battery.
- The backup battery charges when the main battery is inserted into the camera or when the camera is connected to an optional AC adapter, and can provide several days of backup power after about ten hours of charging.
- If the camera's backup battery becomes exhausted, the date and time setting screen is displayed when the camera is turned on. Set the date and time again. → Step 3 of "Preparation 3 Set the Display Language, Date, and Time" (📖 16)

## Imprinting the Shooting Date in Printed Images

- Set the date and time before shooting.
- You can permanently imprint the shooting date in images as they are captured by setting **Print date** (🔍47) in the setup menu (📖 86).
- If you want the shooting date to be printed without using the **Print date** setting, print using the ViewNX 2 software (📖 71).

# Step 1 Turn the Camera On and Select Shooting Mode

## 1 Press the power switch to turn on the camera.

- The lens extends and the monitor turns on.

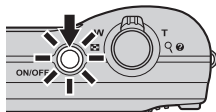

## 2 Press the button.

- The shooting-mode selection menu, which allows you to select the desired shooting mode, is displayed.

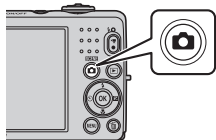

## 3 Press the multi selector or to select a shooting mode and press the .

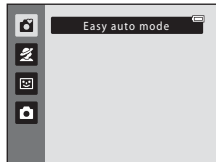

-  (easy auto) mode is used in this example.





## 4 Check the battery level indicator and the number of exposures remaining.

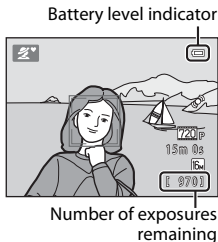

### Battery Level Indicator

Display	Description
	Battery level high.
	Battery level low. Prepare to replace the batteries.
<b>Battery exhausted.</b>	Cannot take pictures. Replace the batteries.



### Number of Exposures Remaining

The number of pictures that can be taken is displayed.

-  is displayed when no memory card is inserted in the camera, and images will be saved in the internal memory (approx. 20 MB).
- The number of exposures remaining depends on the amount of available memory in the internal memory or memory card, and also varies depending on the image quality and image size (determined by the image mode setting;  61).

## Turning the Camera On and Off

- When the camera is turned on, the power-on lamp (green) will light and then the monitor will turn on (the power-on lamp turns off when the monitor turns on).
- To turn off the camera, press the power switch. When the camera turns off, the power-on lamp and the monitor turn off.
- You can press and hold the  (playback) button to turn on the camera and switch to playback mode. The lens will not extend.

## Power Saving Function (Auto Off)

If no operations are performed for a while, the monitor will turn off, the camera will enter standby mode, and the power-on lamp will flash. If no operations are performed for approximately another three minutes, the camera will turn off automatically.

While the camera is in standby mode, the monitor turns back on if you perform any of the following operations:

→ Press the power switch, shutter-release button,  (shooting mode) button,  (playback) button, or  (movie-record) button

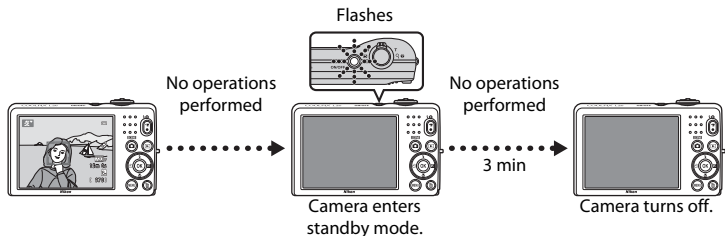

- The time that elapses before the camera enters standby mode can be changed using the **Auto off** setting in the setup menu (📖 86).
- By default, the camera enters standby mode in about 30 seconds when you are using shooting mode or playback mode.

## Step 2 Frame a Picture

### 1 Hold the camera steady.

- Keep fingers, hair, the camera strap, and other objects away from the lens, flash, AF assist-illuminator (L26 only), and microphone.
- When taking pictures in portrait (“tall”) orientation, turn the camera so that the flash is above the lens.

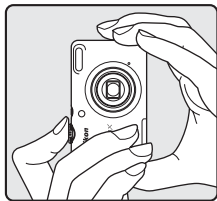
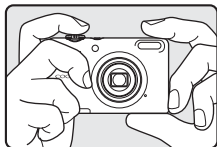

### 2 Frame the picture.

- When the camera determines the scene mode, the shooting mode icon will change (📖 34).
- When the camera detects a human face, that face is framed by a yellow double border (focus area).
- When shooting non-human subjects or when no faces are detected, the camera focuses on the subject in the center of the frame. Position the main subject near the center of the frame.

Shooting mode icon

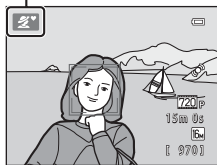

## ✓ Easy Auto Mode

- Depending upon shooting conditions, the camera may not select the desired scene mode. In this case, select another shooting mode (📖 34, 35, 43, 47).
- When digital zoom is in effect, the shooting mode is 📷.

## 📎 When Using a Tripod

We recommend using a tripod to stabilize the camera in the following situations.

- When shooting in dimly lit conditions with the flash mode (📖 51) set to 📷 (off)
- When zooming in on the subject

## Using the Zoom

Use the zoom control to activate optical zoom.

- To zoom in closer to the subject, rotate the zoom control to **T** (telephoto).
- To zoom out and view a larger area, rotate the zoom control to **W** (wide-angle).

When you turn the camera on, the zoom moves to the maximum wide-angle position.

- A zoom indicator is displayed at the top of the monitor when the zoom control is rotated.

Zoom out **W**      **T** Zoom in

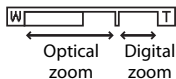
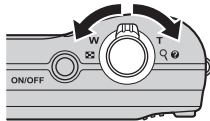

## Digital Zoom

When the camera is zoomed in to the maximum optical zoom position, rotating and holding the zoom control at **T** triggers digital zoom.

Digital zoom can magnify the subject up to about 4x beyond the maximum magnification of the optical zoom.

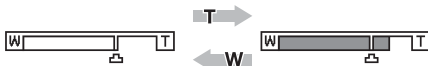

Maximum optical zoom

Digital zoom enabled

- When you are using digital zoom, the camera focuses on the subject in the center of the frame and the focus area is not displayed.

## Digital Zoom and Interpolation

Unlike optical zoom, digital zoom uses a digital imaging process known as interpolation to magnify images, resulting in slight deterioration of picture quality according to the image mode (📖 60) and digital zoom magnification.

Interpolation is applied at zoom positions beyond  when taking still images.

When zoom is increased beyond the  position, interpolation is initiated and the zoom indicator turns yellow to indicate that interpolation is being applied.

The position of  moves to the right as image size decreases, allowing you to confirm the zoom position at which shooting without interpolation is possible at the current image mode setting.



## Step 3 Focus and Shoot

### 1 Press the shutter-release button halfway (📖 27).

- When a face is detected:  
The camera focuses on the face framed by the double border. When the subject is in focus, the double border glows green.
- When a face is not detected:  
The camera focuses on the subject in the center of the frame. When the camera has focused, the focus area glows green.
- When you are using digital zoom, the camera focuses on the subject in the center of the frame and the focus area is not displayed. When the camera has focused, the focus indicator (📖 6) glows green.
- While the shutter-release button is pressed halfway, the focus area or focus indicator may flash red. This indicates that the camera is unable to focus. Modify the composition and press the shutter-release button halfway again.

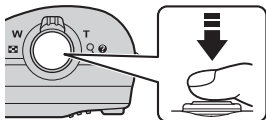



### 2 Press the shutter-release button the rest of the way down (📖 27).

- The shutter is released and the image will be saved to the memory card or internal memory.



## The Shutter-release Button

<p>Press halfway</p>		<p>To set focus and exposure (shutter speed and aperture value), press the shutter-release button halfway, stopping when you feel resistance. Focus and exposure remain locked while the shutter-release button is pressed halfway.</p>
<p>Press all the way</p>		<p>While pressing the shutter-release button halfway, press the shutter-release button the rest of the way down to release the shutter and take a picture. Do not use force when pressing the shutter-release button, as this may result in camera shake and blurred images. Press the button gently.</p>

### Notes About Saving Data

After taking a picture or recording a movie, the number of exposures remaining or the remaining recording time flashes while images or movies are being saved. **Do not open the battery-chamber/memory card slot cover** while images or movies are being saved. Image and movie data could be lost and the camera or memory card could be damaged.

## Autofocus

The camera may not focus as expected in the following situations. In some rare cases, the subject may not be in focus despite the fact that the focus area or the focus indicator glows green:



- Subject is very dark
- Objects of sharply differing brightness are included in the scene (e.g. the sun behind the subject makes that subject appear very dark)
- No contrast between the subject and surroundings (e.g. a portrait subject, wearing a white shirt, is standing in front of a white wall)
- Several objects are at different distances from the camera (e.g. the subject is inside a cage)
- Subjects with repeating patterns (window blinds, buildings with multiple rows of similarly shaped windows, etc.)
- Subject is moving rapidly

In the situations noted above, try pressing the shutter-release button halfway to refocus several times, or select auto mode and use focus lock ( 64) to take the picture by first focusing on an object that is the same distance from the camera as the desired subject.

## Notes About Face Detection

See “Using Face Detection” ( 63) for more information.

## AF-assist Illuminator (L26 Only) and Flash

If the subject is dimly lit, the AF-assist illuminator (L26 only;  86) may light when the shutter-release button is pressed halfway, and the flash ( 50) may fire when the shutter-release button is pressed all the way down.

## To Make Sure You Do Not Miss a Shot

If you are concerned that you might miss a shot, press the shutter-release button all the way without first pressing it halfway.







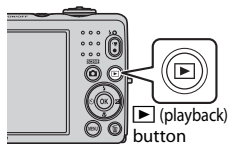

## Step 4 Play Back Images

### 1 Press the (playback) button.

- The camera switches to playback mode and the last image saved is displayed full-frame.



### 2 Use the multi selector to select an image to display.

- Display the previous image:  or 
- Display the next image:  or 
- Remove the memory card from the camera to play back images saved in the camera's internal memory.  is displayed near the current image number/total number of images display.
- To return to shooting mode, press the  button or the  (movie-record) button.

Display the previous image



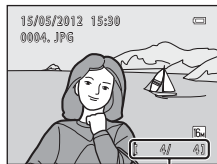

Display the next image





Current image number/  
total number of images

## Viewing Images

- Images may be displayed briefly at low resolution while being read from the memory card or internal memory.
- When you play back images in which the face of a person ( 63) or pet ( 42) was detected at the time of shooting, depending on the orientation of the detected face, the images are automatically rotated for playback display.



## More Information

- Playback Zoom →  66
- Thumbnail Display, Calendar Display →  67
- Features Available in Playback Mode (Playback Menu) →  68

## Step 5 Delete Images

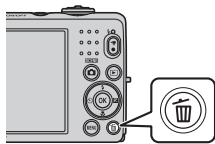

- 1 Press the  button to delete the image currently displayed in the monitor.



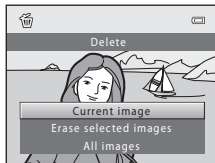

- 2 Press the multi selector  or  to select the desired deletion method and press the  button.

- **Current image:** Only the current image is deleted.
- **Erase selected images:** Multiple images can be selected and deleted ( 32).
- **All images:** All images are deleted.
- To exit without deleting, press the **MENU** button.



- 3 Press  or  to select **Yes** and press the  button.

- Deleted images cannot be recovered.
- To cancel, press  or  to select **No** and press the  button.

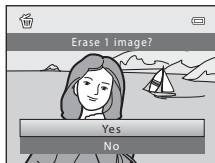

## Operating the Erase Selected Images Screen

- 1 Press the multi selector ◀ or ▶ to select an image to be deleted, and then press ▲ to display ✓.

  - To undo the selection, press ▼ to remove ✓.
  - Rotate the zoom control (Ⓛ 2, 4) to **T** (Ⓚ) to switch back to full-frame playback or **W** (Ⓜ) to display thumbnails.

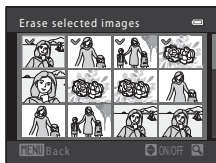

- 2 Add ✓ to all images that you want to delete and then press the Ⓚ button to confirm the selection.

  - A confirmation dialog is displayed. Follow the instructions displayed in the monitor.

### ✓ Notes About Deletion

- Deleted images cannot be recovered. Copy important images to a computer before deleting them from the camera.
- Protected images (Ⓛ 68) cannot be deleted.

### ✍ Deleting the Last Image Captured While in Shooting Mode



When using shooting mode, press the 🗑 button to delete the last image that was saved.



# Shooting Features



This chapter describes the camera's shooting modes and the features that are available when using each shooting mode.

You can select shooting modes and adjust settings according to the shooting conditions and the kind of images you want to capture.

 <b>(Easy Auto) Mode</b> .....	<b>34</b>
<b>Scene Mode (Shooting Suited to Scenes) .....</b>	<b>35</b>
<b>Smart Portrait Mode (Capturing Smiling Faces) ...</b>	<b>43</b>
 <b>(Auto) Mode .....</b>	<b>47</b>
<b>Features That Can Be Set Using the Multi Selector ....</b>	<b>49</b>
Using the Flash (Flash Modes) .....	50
Using the Self-timer .....	53
Using Macro Mode.....	55
Adjusting Brightness (Exposure Compensation).....	57
<b>Changing the Image Size (Image Mode).....</b>	<b>60</b>
<b>Features That Cannot Be Used Simultaneously.....</b>	<b>62</b>
<b>Focusing .....</b>	<b>63</b>

### (Easy Auto) Mode

The camera automatically selects the optimum scene mode when you frame a picture.







Enter shooting mode →  (shooting mode) button →  (easy auto) mode →  button

#### Automatic Scene Selection

The camera automatically selects one of the following scenes when you point the camera at a subject:









-  Portrait (📖 36)
-  Landscape (📖 36)
-  Night portrait (📖 37)
-  Night landscape (📖 39)
-  Close-up (📖 39)
-  Backlighting (📖 40)
-  Other scenes

#### Changing (Easy Auto) Mode Settings





































- Depending on the scene selected by the camera, you can press the multi selector  () ,  () , and  () to set the corresponding features. → “Features That Can Be Set Using the Multi Selector” (📖 49), “Default Settings” (📖 58)
- Features that can be set by pressing the **MENU** button → Image mode, which is the combination of image size and image quality (📖 60)

## Scene Mode (Shooting Suited to Scenes)



When one of the following scenes is selected, camera settings are automatically optimized for the selected scene.

Enter shooting mode →  (shooting mode) button →  (second icon from the top\*)  
→   , , ,  → select a scene →  button

\* The icon of the last scene selected is displayed.

 Portrait (default setting;  36)	 Landscape (  36)	 Sports (  37)	 Night portrait (  37)
 Party/indoor (  37)	 Beach (  38)	 Snow (  38)	 Sunset (  38)
 Dusk/dawn (  38)	 Night landscape (  39)	 Close-up (  39)	 Food (  39)
 Museum (  40)	 Fireworks show (  40)	 Black and white copy (  40)	 Backlighting (  40)
 Panorama assist (  41)	 Pet portrait (  42)		

### To View a Description (Help Display) of Each Scene

Select the desired scene from the scene selection screen and rotate the zoom control ( 2, 4) to **T**  to view a description of that scene. To return to the original screen, rotate the zoom control to **T**  again.



## Changing Scene Mode Settings

- Depending on the scene, the multi selector ▲ (🔧), ▼ (👤), ◀ (🕒), and ▶ (📷) can be used to set the corresponding features. → “Features That Can Be Set Using the Multi Selector” (📖 49), “Default Settings” (📖 58)
- Features that can be set by pressing the **MENU** button → Image mode, which is the combination of image size and image quality (📖 60)

## Characteristics of Each Scene

### 👤 Portrait

Use this mode for portraits.

- When the camera detects a human face, it focuses on that face (📖 63).
- You can use the skin softening option to smooth the skin tones in human faces (📖 46).
- If no faces are detected, the camera focuses on the subject in the center of the frame.
- Digital zoom cannot be used.



### 🏡 Landscape

Use this mode for vivid landscapes and cityscapes.

- The focus area or focus indicator (📖 7) always glows green when the shutter-release button is pressed halfway.





📷: Use of a tripod is recommended when using scene modes indicated with 📷.



## Sports

Use this mode when shooting sporting events. The camera captures a series of still images that allow you to clearly see detailed movements in a moving subject.



- The camera focuses on the area in the center of the frame.
- Press and hold the shutter-release button all the way to capture images continuously. The camera captures up to four images continuously at a rate of about 1.2 fps when **Image mode** is set to  (for L26) or  (for L25).
- The camera focuses even when the shutter-release button is not pressed halfway. You may hear the sound of the camera focusing.
- Focus, exposure, and hue are fixed at the values determined with the first image in each series.
- The frame rate with continuous shooting may vary depending upon the current image mode setting, the memory card used, or shooting condition.



## Night portrait



Use this mode for evening and night portraits that include background scenery. The flash fires to light the portrait subject while preserving background lighting to achieve a natural balance between the main subject and background ambience.

- When the camera detects a human face, it focuses on that face ( 63).
- You can use the skin softening option to smooth the skin tones in human faces ( 46).
- If no faces are detected, the camera focuses on the subject in the center of the frame.
- Digital zoom cannot be used.



## Party/indoor

Suitable for taking pictures at parties. Captures the effects of candlelight and other indoor background lighting.

- The camera focuses on the area in the center of the frame.
- As images are easily affected by camera shake, hold the camera steadily. In a dark place, the use of a tripod is recommended.



 Beach

Captures the brightness of such subjects as beaches or sunlit expanses of water.

- The camera focuses on the area in the center of the frame.

 Snow

Captures the brightness of sunlit snow.

- The camera focuses on the area in the center of the frame.



 Sunset

Preserves the deep hues seen in sunsets and sunrises.

- The camera focuses on the area in the center of the frame.

 Dusk/dawn

Preserves the colors seen in the weak natural light before sunrise or after sunset.

- The focus area or focus indicator (  7 ) always glows green when the shutter-release button is pressed halfway.



## Night landscape





Slow shutter speeds are used to capture stunning night landscapes.

- The focus area or focus indicator ( 7) always glows green when the shutter-release button is pressed halfway.



## Close-up





Use this mode to photograph flowers, insects, and other small objects at close range.

- Macro mode ( 55) is enabled and the camera automatically zooms to the closest position at which it can focus.
- The camera focuses on the area in the center of the frame. Use focus lock to frame the picture on an object not in the center of the frame ( 64).
- The camera focuses even when the shutter-release button is not pressed halfway. You may hear the sound of the camera focusing.



## Food

Use this mode when taking pictures of food.

- Macro mode ( 55) is enabled and the camera automatically zooms to the closest position at which it can focus.
- You can adjust hue by pressing the multi selector  and . The hue setting is saved in the camera's memory even after the camera is turned off.
- The camera focuses on the area in the center of the frame. Use focus lock to frame the picture on an object not in the center of the frame ( 64).
- The camera focuses even when the shutter-release button is not pressed halfway. You may hear the sound of the camera focusing.

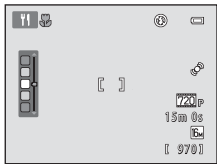

## Museum

Use indoors where flash photography is prohibited (for example, in museums and art galleries) or in other settings in which you do not want to use the flash.

- The camera focuses on the area in the center of the frame.
- The camera captures a series of up to ten images while the shutter-release button is held all the way down, and the sharpest image in the series is automatically selected and saved (best shot selector).



## Fireworks show



Slow shutter speeds are used to capture the light from fireworks.

- Camera focuses at infinity.
- When the shutter-release button is pressed halfway, the focus indicator ( 7) always glows green.



## Black and white copy

Provides clear images of text or drawings on a whiteboard or in print.

- The camera focuses on the area in the center of the frame.
- Use together with macro mode ( 55) when shooting subjects that are close to the camera.

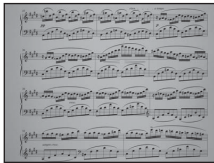

## Backlighting

Use when light is coming from behind the subject, throwing features or details into shadow. The flash fires automatically to “fill in” (illuminate) shadows.









- The camera focuses on the area in the center of the frame.



 Use of a tripod is recommended when using scene modes indicated with .





Use this setting to capture a series of images that will be connected using a computer to form a panorama image (.

- Press the multi selector , ,  or  to select the direction that you will move the camera in when capturing images, and press the .
- After shooting the first image, confirm on the screen how the captured image will be connected to the next image, and shoot the next image. Shoot as many images as needed to complete the panorama. To finish shooting, press the .
- Transfer the images to your computer and use the Panorama Maker 6 ( 73, ) software to combine the images into a single panorama image.

## Pet portrait

Use this mode when taking pictures of dogs or cats. When the camera detects the face of a dog or cat, the camera focuses on that face. Once the camera has focused, by default it automatically releases the shutter (pet portrait auto release).





- From the screen displayed after the  **Pet portrait** scene mode is selected, select **Single** or **Continuous**.
  - Single:** Images are captured one at a time.
  - Continuous:** When a face is focused on, the camera captures three images continuously at a rate of about 1.2 fps when **Image mode** is set to  **4608×3456** (for L26) or  **3648×2736** (for L25).

- When the camera detects a face, a double border (focus area) is displayed around the face, and the double border glows green when the camera has focused.

The faces of up to five pets can be detected at the same time.

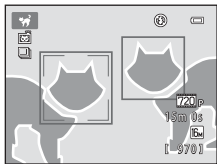
When the camera detects more than one face, the face displayed largest in the monitor is framed by a double border and the others by single borders.



- If no pet faces are detected, you can release the shutter by pressing the shutter-release button.
  - If no pet faces are detected, the camera focuses on the subject at the center of the frame.
  - When **Continuous** is selected, the camera captures up to four images continuously while the shutter-release button is held all the way down at a rate of about 1.2 fps when **Image mode** is set to  **4608×3456** (for L26) or  **3648×2736** (for L25).

- Press the multi selector  (☺) to change auto release settings. When set to **Off**, the shutter is released only when the shutter-release button is pressed.



- Pet portrait auto release** turns off automatically when:
  - Five bursts have been taken
  - Internal memory or the memory card is full

To continue using **Pet portrait auto release** to take more pictures, press the multi selector  (☺) and change the setting again.

- Digital zoom cannot be used.
- Depending on the distance of the pet from the camera, the speed of the pet's movement, the direction the pet is facing, the ambient brightness of the pet's face, etc., pet faces may not be detected or other subjects may be displayed with a border.

# Smart Portrait Mode (Capturing Smiling Faces)

When the camera detects a smiling face, you can take a picture automatically without pressing the shutter-release button (smile timer). You can use the skin softening option to smooth the skin tones in human faces.

Enter shooting mode →  (shooting mode) button →  Smart portrait mode →  button

## 1 Frame the picture.

- When the camera detects a human face, a yellow double border (focus area) is displayed around that face. When the camera has focused on that face, the double border will turn green for a moment and focus is locked.
- Up to three faces can be detected. When the camera detects more than one face, a double border is displayed around the face closest to the center of the frame, and single borders are displayed around the other faces.

## 2 Wait for the subject to smile. Do not press the shutter-release button.

- If the camera detects that the face framed by the double border is smiling, the **Smile timer** (📖 45, ⚙️ 23) feature is activated and the shutter is automatically released.
- After the camera releases the shutter, it will continue to detect faces and smiles, and will release the shutter again if it detects a smiling face.

## 3 Shooting ends.

- Any one of the following operations can be used to cancel smile detection and stop shooting.
  - Turn the camera off.
  - Set **Smile timer** (📖 45, ⚙️ 23) to **Off**.
  - Press the  button and select a different shooting mode.

## ✔ Notes About Smart Portrait Mode

- Digital zoom cannot be used.
- Under some shooting conditions, the camera may be unable to detect faces or detect smiles.
- “Notes About Face Detection” →  63

## ✎ Auto Off in Smile Timer Mode

When **Smile timer** is set to **On**, the auto off function ( 86) is activated and the camera turns off when either of the situations indicated below persists and no other operations are performed.

- The camera does not detect any faces.
- The camera detected a face, but cannot detect a smile.





## ✎ When the Self-timer Lamp Flashes

When using smile timer, the self-timer lamp flashes when the camera detects a face and flashes quickly immediately after the shutter is released.

## ✎ Releasing the Shutter Manually

The shutter can also be released by pressing the shutter-release button. If no faces are detected, the camera focuses on the subject at the center of the frame.

## Changing Smart Portrait Mode Settings

- Features that can be set using the multi selector ( 49) → Flash mode ( 50), self-timer ( 53), and exposure compensation ( 57)
- Features that can be set by pressing the **MENU** button → Options Available in the Smart Portrait Menu ( 45)

## ✎ Features That Cannot Be Used Simultaneously

Some settings cannot be used with other functions ( 62).





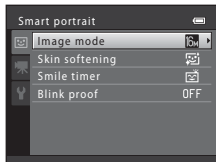

## Options Available in the Smart Portrait Menu

When using  smart portrait mode, the following settings can be changed.

Select smart portrait mode (📖 43) → MENU button →  tab



Option	Description	
Image mode	Allows you to select the combination of image size and image quality used when saving images (📖 60). If you change the image mode setting, the new setting is applied to all shooting modes.	60
Skin softening	Enable skin softening. Make the skin tones in human faces smoother. The default setting is <b>On</b> .	 22
Smile timer	When <b>On</b> (default setting) is selected, the camera detects human faces and then automatically releases the shutter whenever a smile is detected. Self-timer cannot be used with this feature.	 23
Blink proof	When <b>On</b> is selected, the camera automatically releases the shutter twice each time a picture is taken. Of the two shots, the image in which the subject's eyes are more open compared to the other shot is saved. The flash cannot be used when <b>On</b> is selected. The default setting is <b>Off</b> .	 23

### Features That Cannot Be Used Simultaneously

Some settings cannot be used with other functions (📖 62).

## Using Skin Softening

When the shutter is released in one of the following shooting modes, the camera detects one or more human faces (up to three), and processes the image to soften facial skin tones.

- **Portrait** (📖 36) and **Night portrait** (📖 37) in 📷 (easy auto) mode
- **Portrait** (📖 36) or **Night portrait** (📖 37) scene mode
- Smart portrait mode (📖 43)



Skin softening can also be applied to saved images (📖 68, 📷 8).

### ✔ Notes About Skin Softening

- It may take more time than usual to save images after shooting.
- Under some shooting conditions, the desired skin softening results may not be achieved, or skin softening may be applied to areas of the image where there are no faces.

## (Auto) Mode

Used for general shooting. Settings can be adjusted in the shooting menu (📖 48) to suit the shooting conditions and the type of shot you want to capture.

Enter shooting mode →  (shooting mode) button →  (auto) mode →  button

- The camera focuses on the area in the center of the frame.

## Changing (Auto) Mode Settings



- Features that can be set using the multi selector (📖 49) → Flash mode (📖 50), self-timer (📖 53), macro mode (📖 55), and exposure compensation (📖 57)
- Features that can be set by pressing the **MENU** button → Options Available in the Auto Shooting Menu (📖 48)

## Features That Cannot Be Used Simultaneously





Some settings cannot be used with other functions (📖 62).

## Options Available in the Auto Shooting Menu

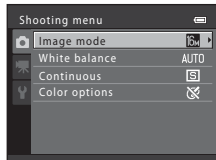
When using  (auto) mode, the following settings can be changed.

Select  (auto) mode (📖 47) → MENU button →  tab



Option	Description	
Image mode	Allows you to select the combination of image size and image quality used when saving images (📖 60). This setting is also applied to other shooting modes.	60
White balance	Allows you to adjust white balance to suit the light source in order to make the colors in images match what you see with your eye. The available settings are <b>Auto</b> (default setting), <b>Preset manual</b> , <b>Daylight</b> , <b>Incandescent</b> , <b>Fluorescent</b> , <b>Cloudy</b> , and <b>Flash</b> .	 24
Continuous	Allows you to capture a series of images. The available settings are <b>Single</b> (default setting), <b>Continuous</b> , <b>BSS</b> , and <b>Multi-shot 16</b> .	 27
Color options	Allows you to change the color tones of images at the time of shooting. The available settings are <b>Standard color</b> (default setting), <b>Vivid color</b> , <b>Black-and-white</b> , <b>Sepia</b> , and <b>Cyanotype</b> .	 28

### Features That Cannot Be Used Simultaneously

Some settings cannot be used with other functions (📖 62).

## Features That Can Be Set Using the Multi Selector

When shooting, the multi selector ▲, ▼, ◀, and ▶ can be used to set the following features.

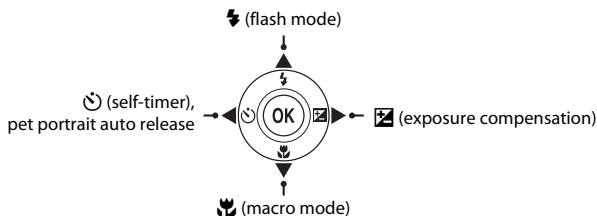

## Available Features

The features that are available vary with the shooting mode, as shown below.

- See "Default Settings" (📖 58) for information about each mode's default settings.

	📷 (easy auto)	Scene	Smart portrait	📷 (auto)
⚡ Flash mode (📖 50)	✓ <sup>1</sup>	2	✓ <sup>3</sup>	✓
🕒 Self-timer (📖 53)	✓		✓ <sup>3</sup>	✓
Pet portrait auto release (📖 42)	–		–	–
🌸 Macro (📖 55)	–		–	✓
📐 Exposure compensation (📖 57)	✓		✓	✓

<sup>1</sup> Varies by the scene selected by the camera. → "Default Settings" (📖 58)

<sup>2</sup> Varies by the scene. → "Default Settings" (📖 58)

<sup>3</sup> Varies by the smart portrait menu setting. → "Default Settings" (📖 58)

# Using the Flash (Flash Modes)

You can set the flash mode.

- 1 Press the multi selector ▲ (⚡ flash mode).



- 2 Press the multi selector ▲ or ▼ to select the desired mode and press the OK button.

- Available Flash Modes → 51
- If a setting is not applied by pressing the OK button within a few seconds, the selection will be canceled.
- When **⚡AUTO** (auto) is applied, **⚡AUTO** is only displayed for a few seconds, regardless of **Monitor settings** ( 86, 45).

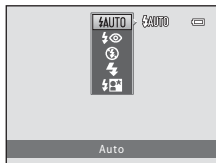

## The Flash Lamp

The flash lamp indicates the status of the flash when you press the shutter-release button halfway.

- On: The flash fires when a picture is taken.
- Flashing: The flash is charging. The camera cannot take pictures.
- Off: The flash will not fire when a picture is taken.

If the battery is low, the monitor will turn off while the flash is charging.

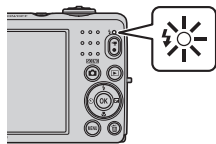

## Effective Range of the Flash

For L26, the flash has a range of approx. 0.5 to 3.6 m (1 ft 8 in. to 11 ft) at the maximum wide-angle zoom position and a range of approx. 0.8 to 1.7 m (2 ft 8 in. to 5 ft 6 in.) at the maximum telephoto zoom position. For L25, the flash has a range of approx. 0.3 to 4.2 m (1 ft to 13 ft) at the maximum wide-angle zoom position and a range of approx. 0.6 to 1.6 m (2 ft to 5 ft 2 in.) at the maximum telephoto zoom position.

## Available Flash Modes



### Auto

The flash fires automatically when lighting is dim.



### Auto with red-eye reduction

Reduce red-eye in portraits caused by the flash (📖 52).



### Off

The flash will not fire.

- We recommend using a tripod to stabilize the camera when shooting in dark surroundings.



### Fill flash

The flash fires whenever a picture is taken. Use to “fill-in” (illuminate) shadows and backlit subjects.



### Slow sync

Auto flash mode is combined with slow shutter speed.

Suited to evening and night portraits that include background scenery.

The flash illuminates main subject; slow shutter speeds are used to capture background at night or under dim lighting.

## The Flash Mode Setting

- The setting varies with the shooting mode.
  - “Available Features” (📖 49)
  - “Default Settings” (📖 58)
- Some settings cannot be used with other functions (📖 62).
- The flash mode setting applied in  (auto) mode is saved in the camera’s memory even after the camera is turned off.

## Red-eye Reduction

This camera uses **Advanced Red-Eye Reduction** (In-Camera Red-Eye Fix).

Pre-flashes are fired repeatedly at low intensity before the main flash, reducing the red-eye effect.

Additionally, if the camera detects red eye while saving an image, the affected area will be processed to reduce red-eye before the image is saved.

Note the following when shooting:

- Because pre-flashes are fired, there is a slight lag between when the shutter-release button is pressed and when the shutter is released.
- More time than usual is required to save images.
- Red-eye reduction may not produce the desired results in all situations.
- In rare cases, areas of the image that are not affected by red-eye may be processed by red-eye reduction. In these cases, select another flash mode and take the picture again.



## Using the Self-timer

The camera's self-timer can release the shutter about ten seconds after you press the shutter-release button. The self-timer is useful when you want to be in the picture you are taking, or when you want to avoid the effects of camera shake that occur when you press the shutter-release button. When using the self-timer, use of a tripod is recommended.

- 1 Press the multi selector ◀ (⌚ self-timer).



- 2 Press the multi selector ▲ or ▼ to select **ON** and press the **OK** button.

- ⌚10 is displayed.
- If a setting is not applied by pressing the **OK** button within a few seconds, the selection will be canceled.
- When the shooting mode is the **Pet portrait** scene mode,  (Pet portrait auto release) is displayed (📖 42). Self-timer cannot be used.



- 3 Frame the picture and press the shutter-release button halfway.

- Focus and exposure will be set.



## 4 Press the shutter-release button the rest of the way down.

- The self-timer starts, and the number of seconds remaining before the shutter is released is displayed in the monitor. The self-timer lamp flashes while the timer is counting down. About one second before the shutter is released, the lamp stops flashing and glows steadily.
- When the shutter is released, the self-timer will be set to **OFF**.
- To stop the timer before a picture is taken, press the shutter-release button again.



## Using Macro Mode

When using macro mode, the L26 can focus on objects as close as about 10 cm (4 in.) from the front of the lens. The L25 can focus on objects as close as about 3 cm (1.2 in.) from the front of the lens.

This feature is useful when taking close-up pictures of flowers and other small subjects.

- 1 Press the multi selector ▼ (🌸 macro mode).



- 2 Press the multi selector ▲ or ▼ to select ON and press the OK button.

- The macro mode icon (🌸) is displayed.
- If a setting is not applied by pressing the OK button within a few seconds, the selection will be canceled.

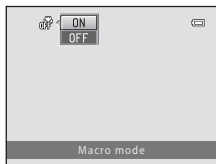

- 3 Use the zoom control to set the zoom position to a position where 🌸 and the zoom indicator glow green.

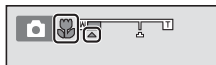

- How close you can be to the subject when shooting depends on the zoom position. When the zoom position is set to a position where 🌸 and the zoom indicator glow green, the L26 can focus on subjects as close as about 30 cm (1 ft) from the lens, and the L25 can focus on subjects as close as about 10 cm (4 in.) from the lens. When the zoom position is set to a wide-angle position relative to 🌸, the L26 can focus on subjects as close as about 10 cm (4 in.) from the lens. When the zoom position is set to a position where 🌸 is displayed, the L25 can focus on subjects as close as about 3 cm (1.2 in.) from the lens.

## **Notes About Using the Flash**

The flash may be unable to light the entire subject at distances of less than 50 cm (1 ft 8 in.) for the L26 and less than 30 cm (1 ft) for the L25.

## **Autofocus**

When shooting still images in macro mode, the camera focuses continuously until the shutter-release button is pressed halfway to lock the focus. You may hear the sound of the camera focusing.

## **The Macro Mode Setting**



- Macro mode cannot be used when using certain shooting modes. → “Default Settings” (📖 58)
- The macro mode setting applied in  (auto) mode is saved in the camera’s memory even after the camera is turned off.

# Adjusting Brightness (Exposure Compensation)

You can adjust overall image brightness.

- 1 Press the multi selector  (exposure compensation).



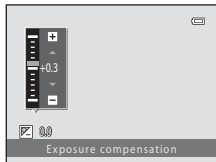

- 2 Press the multi selector  or  to select a compensation value.

- To make the image brighter, apply positive (+) exposure compensation.
- To make the image darker, apply negative (-) exposure compensation.



- 3 Press the  button to apply the compensation value.

- If you do not press the  button within a few seconds, the setting will be applied and the menu will disappear.
- When an exposure compensation value other than **0.0** is applied, the value is displayed with the  indicator in the monitor.



- 4 Press the shutter-release button to take a picture.









































































- To turn off exposure compensation, return to step 1 and change the value to **0.0**.

## Exposure Compensation Value

The exposure compensation value applied in  (auto) mode is saved in the camera's memory even after the camera is turned off.

## Default Settings

Default settings for each shooting mode are described below.

	Flash (  50)	Self-timer (  53)	Macro (  55)	Exposure compensation (  57)
 (easy auto;  34)	 AUTO <sup>1</sup>	Off	Off <sup>2</sup>	0.0
 (smart portrait;  43)	 AUTO <sup>3</sup>	Off <sup>4</sup>	Off <sup>5</sup>	0.0
 (auto;  47)	 AUTO	Off	Off	0.0
<b>Scene</b>				
 (  36)	 	Off	Off <sup>5</sup>	0.0
 (  36)	 <sup>5</sup>	Off	Off <sup>5</sup>	0.0
 (  37)	 <sup>5</sup>	Off <sup>5</sup>	Off <sup>5</sup>	0.0
 (  37)	  <sup>6</sup>	Off	Off <sup>5</sup>	0.0
 (  37)	  <sup>7</sup>	Off	Off <sup>5</sup>	0.0
 (  38)	 AUTO	Off	Off <sup>5</sup>	0.0
 (  38)	 AUTO	Off	Off <sup>5</sup>	0.0
 (  38)	 <sup>5</sup>	Off	Off <sup>5</sup>	0.0
 (  38)	 <sup>5</sup>	Off	Off <sup>5</sup>	0.0
 (  39)	 <sup>5</sup>	Off	Off <sup>5</sup>	0.0
 (  39)	 <sup>5</sup>	Off	On <sup>5</sup>	0.0
 (  39)	 <sup>5</sup>	Off	On <sup>5</sup>	0.0
 (  40)	 <sup>5</sup>	Off	Off	0.0
 (  40)	 <sup>5</sup>	Off <sup>5</sup>	Off <sup>5</sup>	0.0 <sup>5</sup>
 (  40)	 <sup>5</sup>	Off	Off	0.0
 (  40)	  <sup>5</sup>	Off	Off <sup>5</sup>	0.0
 (  41)	 <sup>5</sup>	Off	Off	0.0
 (  42)	 <sup>5</sup>	 <sup>3</sup>	Off	0.0

- 1 You can select **⚡AUTO** (auto) or **⊖** (off). When **⚡AUTO** (auto) is selected, the camera automatically selects the flash mode appropriate for the scene it has selected.
- 2 The setting cannot be changed. Automatically changes to macro mode when the camera selects **Close-up** scene mode.
- 3 Cannot be used when **Blink proof** is set to **On**.
- 4 Can be set when **Smile timer** is set to **Off**.
- 5 The setting cannot be changed.
- 6 The setting cannot be changed. The flash mode setting is fixed at fill flash with slow sync and red-eye reduction.
- 7 Slow sync with red-eye reduction flash mode may be used.
- 8 Self-timer cannot be used. Pet portrait auto release ( 42) can be set to On or Off.

## Features That Cannot Be Used Simultaneously

Some settings cannot be used with other functions ( 62).













# Changing the Image Size (Image Mode)

Enter shooting mode → MENU button → Shooting menu → Image mode



You can use the **Image mode** setting in the shooting menu to select the combination of image size and compression ratio that is used when saving images.

Select the image mode best suited to the manner in which images will be used and the capacity of the internal memory or memory card.

## Image Mode Settings (Image Size and Quality)

Image mode <sup>1</sup>	Description
 4608×3456★ (L26 only)	Images will be higher quality than  . The compression ratio is approximately 1:4.
 3648×2736★ (L25 only)	Images will be higher quality than  . The compression ratio is approximately 1:4.
 4608×3456 <sup>2</sup> (L26 only)	Best choice in most situations. The compression ratio is approximately 1:8.
 3648×2736 <sup>2</sup> (L25 only)	
 3264×2448	
 2272×1704	
 1600×1200	
 640×480	Suited to full-screen display on a TV with an aspect ratio of 4:3, or distribution by e-mail. The compression ratio is approximately 1:8.
 4608×2592 (L26 only)	Images with an aspect ratio of 16:9 are saved. The compression ratio is approximately 1:8.
 3584×2016 (L25 only)	

<sup>1</sup> The total number of pixels captured, and the number of pixels captured horizontally and vertically. Example:  **4608×3456** = approx. 16 megapixels, 4608 × 3456 pixels

<sup>2</sup>  **4608×3456** is the default setting for L26.  **3648×2736** is the default setting for L25.





## Notes About Image Mode

- The setting is also applied to other shooting modes.
- Some settings cannot be used with other functions (📖 62).



## Number of Images That Can Be Saved

The following table lists the approximate number of images that can be saved in the internal memory and on a 4 GB memory card. Note that due to JPEG compression, the number of images that can be saved varies greatly depending on the composition of the image. In addition, this number varies depending on the make of the memory card, even when the memory cards have the same specified capacity.

Image mode	Internal memory (approx. 20 MB)	Memory card <sup>1</sup> (4 GB)	Print size <sup>2</sup> (cm/in.)
4608×3456★ (L26 only)	2	490	39 × 29/15 × 11.5
3648×2736★ (L25 only)	3	780	31 × 23/12 × 9
4608×3456 (L26 only)	4	970	39 × 29/15 × 11.5
3648×2736 (L25 only)	8	1540	31 × 23/12 × 9
3264×2448	10	1910	28 × 21/11 × 8
2272×1704	20	3820	19 × 14/7.5 × 5.6
1600×1200	39	7240	13 × 10/5.3 × 4
640×480	152	27700	5 × 4/2 × 1.5
4608×2592 (L26 only)	6	1290	39 × 22/15 × 8.5
3584×2016 (L25 only)	11	2110	30 × 17/12 × 6.5

<sup>1</sup> If the number of exposures remaining is 10,000 or more, the number of exposures remaining display shows "9999".

<sup>2</sup> Print size at an output resolution of 300 dpi. Print sizes are calculated by dividing the number of pixels by printer resolution (dpi) and multiplying by 2.54 cm (1 in.). However, at the same image size, images printed at higher resolutions will print smaller than the size indicated, and those printed at lower resolutions will print larger than the size indicated.

## Features That Cannot Be Used Simultaneously

Some shooting settings cannot be used with other functions.

Restricted function	Option	Descriptions
Flash mode	Continuous (📖 48)	When <b>Continuous</b> , <b>BSS</b> , or <b>Multi-shot 16</b> is selected, the flash cannot be used.
	Blink proof (📖 45)	When <b>Blink proof</b> is set to <b>On</b> , the flash cannot be used.
Self-timer	Smile timer (📖 45)	When <b>Smile timer</b> is used for shooting, the self-timer cannot be used.
Digital zoom	Continuous (📖 48)	When <b>Multi-shot 16</b> is selected, digital zoom cannot be used.
Image mode	Continuous (📖 48)	When <b>Multi-shot 16</b> is selected, the <b>Image mode</b> setting is fixed at <b>S</b> (image size: 2560 × 1920 pixels).
White balance	Color options (📖 48)	When using <b>Black-and-white</b> , <b>Sepia</b> , or <b>Cyanotype</b> , the <b>White balance</b> setting is fixed at <b>Auto</b> .
Continuous	Self-timer (📖 53)	When using the self-timer, <b>Continuous</b> is fixed at <b>Single</b> .
Electronic VR	Continuous (📖 48)	When <b>Continuous</b> , <b>BSS</b> , or <b>Multi-shot 16</b> is selected, <b>Electronic VR</b> is disabled.
Motion detection	Continuous (📖 48)	When <b>Multi-shot 16</b> is selected, <b>Motion detection</b> is disabled.
Shutter sound	Continuous (📖 48)	When <b>Continuous</b> , <b>BSS</b> , or <b>Multi-shot 16</b> is selected, the shutter sound is not heard.

# Focusing

## Using Face Detection

In the following shooting modes, the camera uses face detection to automatically focus on human faces. If the camera detects more than one face, a double border is displayed around the face that the camera will focus on, and single borders are displayed around the other faces.

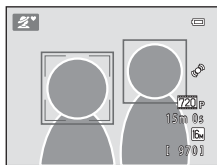

Shooting mode	Number of faces that can be detected	Focus area (double border)
<b>Portrait</b> (📖 36) and <b>Night portrait</b> (📖 37) in 📷 (easy auto) mode	Up to 12	The face closest to the camera
<b>Portrait</b> (📖 36) and <b>Night portrait</b> (📖 37) in scene mode		
Smart portrait mode (📖 43)	Up to 3	The face closest to the center of the frame

- If no faces are detected when the shutter-release button is pressed halfway, the camera will focus on the subject in the center of the frame.

### ✔ Notes About Face Detection

- The camera's ability to detect faces depends on a variety of factors, including whether or not the subject is facing the camera. Additionally, the camera may be unable to detect faces in the following situations:
  - When faces are partially hidden by sunglasses or otherwise obstructed
  - When faces take up too much or too little of the frame
- When the frame includes more than one face, the faces detected by the camera and the face on which the camera focuses depend upon a variety of factors, including the direction in which the faces are looking.
- In some rare cases, such as those described in "Autofocus" (📖 28), the subject may not be in focus even though the double border turns green. Should this occur, use another mode, such as 📷 (auto) mode, and try focus lock shooting (📖 64) by focusing on another subject that is the same distance from the camera.

## Focus Lock

When the camera focuses on an object in the center of the frame, you can use focus lock to focus on an off-center subject.

Use the following procedure when taking pictures using  (auto) mode.

**1** Aim the camera so that the subject is in the center of the frame.

**2** Press the shutter-release button halfway.

- Confirm that the focus area glows green.
- Focus and exposure are locked.



**3** Continue holding down the shutter-release button halfway and recompose the picture.

- Be sure to maintain the same distance between the camera and the subject while the shutter-release button is pressed halfway.

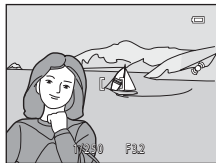

**4** Press the shutter-release button the rest of the way down to take the picture.



# Playback Features

This chapter describes the features that are available when playing back images.

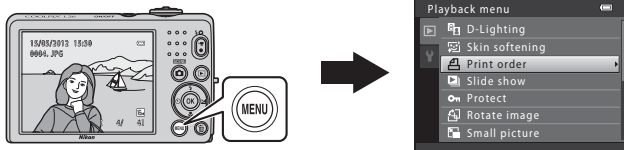

<b>Playback Zoom .....</b>	<b>66</b>
<b>Thumbnail Display, Calendar Display.....</b>	<b>67</b>
<b>Features Available in Playback Mode (Playback Menu) ...</b>	<b>68</b>
<b>Connecting the Camera to a TV, Computer, or Printer ...</b>	<b>69</b>
<b>Using ViewNX 2.....</b>	<b>71</b>
Installing ViewNX 2.....	71
Transferring Images to the Computer .....	74
Viewing Images.....	76

## Playback Zoom

Rotating the zoom control to **T** (Q) in full-frame playback mode (📖 29) zooms in on the center of the image displayed in the monitor.

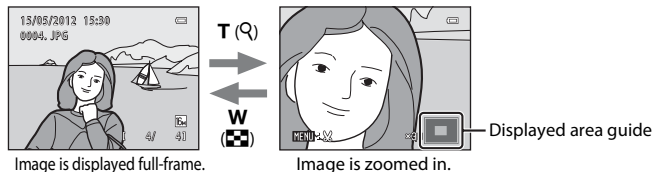

- You can change the zoom ratio by rotating the zoom control to **W** (📐) and **T** (Q). Images can be zoomed up to approximately 10x.
- To view a different area of the image, press the multi selector ▲, ▼, ◀, or ▶.
- If you're viewing an image that was captured using face detection (📖 63) or pet detection (📖 42), the camera zooms in on the face detected at the time of shooting. If the camera detected multiple faces when the image was captured, press ▲, ▼, ◀, or ▶ to display a different face. To zoom in on an area of the image where there are no faces, adjust the magnification rate and then press ▲, ▼, ◀, or ▶.
- You can crop the image and save the displayed area of the image as a separate file by pressing the **MENU** button (🔑 10).
- Press the **OK** button to return to full-frame playback mode.

# Thumbnail Display, Calendar Display

Rotating the zoom control to **W** (📐) in full-frame playback mode (📖 29) displays images in “contact sheets” of thumbnail images.



















- You can view several images on one screen, making it easy to find the image you want.
- You can change the number of thumbnails displayed by rotating the zoom control to **W** (📐) and **T** (🔍).
- Press the multi selector **▲**, **▼**, **◀**, or **▶** to select an image, and then press the **OK** button to display that image full-frame.
- When 16 thumbnails are displayed, rotate the zoom control to **W** (📐) to switch to calendar display.
- While using calendar display mode, press **▲**, **▼**, **◀**, or **▶** to select a date and then press the **OK** button to display the first image captured on that day.



## 📅 Calendar Display

Images captured when the camera's date is not set are treated as images captured on January 1, 2012.

## Features Available in Playback Mode (Playback Menu)

When viewing images in full-frame playback mode or thumbnail playback mode, you can configure the following functions by pressing the **MENU** button (📖 3, 5) to display the menu.

Option	Description	📖
 D-Lighting*	Allows you to create copies with enhanced brightness and contrast, brightening dark portions of an image.	 7
 Skin softening*	The camera detects faces in images and creates a copy with softer facial skin tones.	 8
 Print order	When using a printer to print images saved on the memory card, you can use the <b>Print order</b> function to select which images are printed, and how many copies of each image are printed.	 29
 Slide show	Allows you to view images saved in the internal memory or on a memory card in an automatic slide show.	 32
 Protect	Protects selected images from accidental deletion.	 33
 Rotate image	Specifies the orientation in which saved images are displayed with playback.	 35
 Small picture*	Creates a small copy of the current image. This feature is useful for creating copies for display on Web pages or e-mail attachments.	 9
 Copy	Allows you to copy images between the internal memory and a memory card.	 36

\* Images are edited and saved as separate files. Certain restrictions apply (📖5, 📖6). For example, images captured at an **Image mode** (📖 60) setting of  **4608x2592** for L26 and  **3584x2016** for L25 cannot be edited, and the same editing feature cannot be applied multiple times.



## Connecting the Camera to a TV, Computer, or Printer

You can enhance your enjoyment of images and movies by connecting the camera to a TV, computer, or printer.

- Before connecting the camera to an external device, make sure the remaining battery level is sufficient and turn the camera off. For information about the connection methods and subsequent operations, refer to the documentation included with the device in addition to this document.

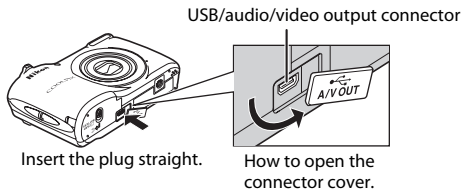

## Viewing images on a TV

 12

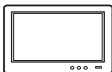

You can view the camera's images and movies on a TV.  
Connection method: Connect the video and audio plugs of the optional Audio Video Cable EG-CP14 to the TV's input jacks.

## Viewing and organizing images on a computer

 71



If you transfer images to a computer, you can perform simple retouching and manage image data in addition to playing back images and movies.

Connection method: Connect the camera to the computer's USB input jack with the included USB Cable UC-E16.

- Before connecting to a computer, install ViewNX 2 on the computer using the included ViewNX 2 Installer CD-ROM. For information about using the ViewNX 2 Installer CD-ROM and transferring images to a computer, see page 71.

## Printing images without using a computer

 15



If you connect the camera to a PictBridge-compatible printer, you can print images without using a computer.

Connection method: Connect the camera directly to the printer's USB input jack with the included USB Cable UC-E16.

## Using ViewNX 2

ViewNX 2 is an all-in-one software package which enables you to transfer, view, edit and share images.

Install ViewNX 2 using the ViewNX 2 Installer CD-ROM.



### Installing ViewNX 2

- An Internet connection is required.

### Compatible Operating Systems

#### Windows

- Windows 7 Home Basic/Home Premium/Professional/Enterprise/Ultimate (Service Pack 1)
- Windows Vista Home Basic/Home Premium/Business/Enterprise/Ultimate (Service Pack 2)
- Windows XP Home Edition/Professional (Service Pack 3)

## Mac OS

- Mac OS X (version 10.5.8, 10.6.8, 10.7.2)

Refer to the Nikon website for the latest information on operating system compatibility.

### 1 Start the computer and insert the ViewNX 2 Installer CD-ROM into the CD-ROM drive.

- Mac OS: When the **ViewNX 2** window is displayed, double-click the **Welcome** icon.

### 2 Select a language in the language selection dialog to open the installation window.

- If the desired language is not available, click **Region Selection** to choose a different region and then choose the desired language (the **Region Selection** button is not available in the European release).
- Click **Next** to display the installation window.

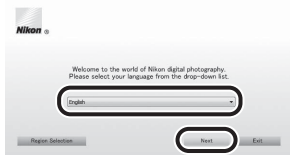

### 3 Start the installer.

- We recommend clicking **Installation Guide** in the installation window to check the installation help information and system requirements before installing ViewNX 2.
- Click **Typical Installation (Recommended)** in the installation window.

---

## 4 Download the software.

- When the **Software Download** screen is displayed, click **I agree - Begin download**.
- Follow the on-screen instructions to install the software.

---

## 5 Exit the installer when the installation completion screen is displayed.

- Windows: Click **Yes**.
- Mac OS: Click **OK**.

The following software is installed:

- ViewNX 2 (consisting of the three modules below)
  - Nikon Transfer 2: For transferring images to the computer
  - ViewNX 2: For viewing, editing, and printing transferred images
  - Nikon Movie Editor: For basic editing of transferred movies
- Panorama Maker 6 (for creating a single panorama photo using a series of images shot in panorama assist scene mode)
- QuickTime (Windows only)

---

## 6 Remove the ViewNX 2 Installer CD-ROM from the CD-ROM drive.

# Transferring Images to the Computer

## 1 Choose how images will be copied to the computer.

Choose one of the following methods:

- **Direct USB connection:** Turn the camera off and ensure that the memory card is inserted in the camera. Connect the camera to the computer using the included USB Cable. Turn the camera on.  
To transfer images that are saved in the camera's internal memory, remove the memory card from the camera before connecting it to the computer.

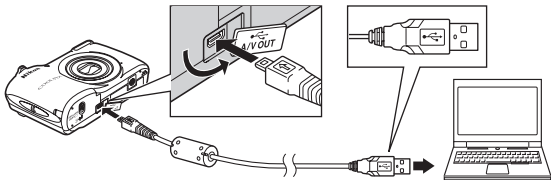

- **SD card slot:** If your computer is equipped with an SD card slot, the card can be inserted directly in the slot.
- **SD card reader:** Connect a card reader (available separately from third-party suppliers) to the computer and insert the memory card.

If a message is displayed prompting you to choose a program, select Nikon Transfer 2.

### • When using Windows 7

If the dialog shown at right is displayed, follow the steps below to select Nikon Transfer 2.

- 1 Under **Import pictures and videos**, click **Change program**. A program selection dialog will be displayed; select **Import File using Nikon Transfer 2** and click **OK**.
- 2 Double-click **Import File**.



If the memory card contains a large number of images, it may take a while for Nikon Transfer 2 to start. Wait until Nikon Transfer 2 starts.

## ✓ Connecting the USB Cable

The connection may not be recognized if the camera is connected to the computer via a USB hub.

## 2 Transfer images to the computer.

- Confirm that the name of the connected camera or removable disk is displayed as the “Source” on the “Options” title bar of Nikon Transfer 2 (①).
- Click **Start Transfer** (②).

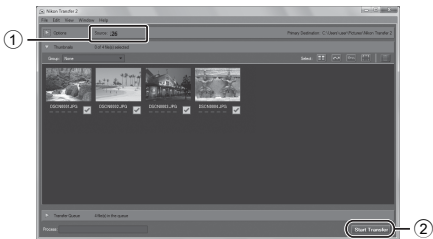

- At default settings, all the images on the memory card will be copied to the computer.

## 3 Terminate the connection.

- If the camera is connected to the computer, turn the camera off and disconnect the USB cable. If you are using a card reader or card slot, choose the appropriate option in the computer operating system to eject the removable disk corresponding to the memory card and then remove the card from the card reader or card slot.

# Viewing Images

## Start ViewNX 2.

- Images are displayed in ViewNX 2 when transfer is complete.
- Consult online help for more information on using ViewNX 2.



### Starting ViewNX 2 Manually

- **Windows:** Double-click the **ViewNX 2** shortcut icon on the desktop.
- **Mac OS:** Click the **ViewNX 2** icon in the Dock.



# Recording and Playing Back Movies

You can record movies by simply pressing the  movie-record button.

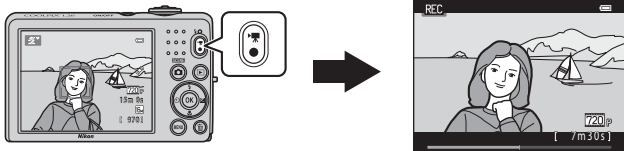

**Recording Movies ..... 78**

    Changing Movie Recording Settings (the Movie Menu) ..... 81

**Playing Back Movies ..... 82**

# Recording Movies

You can record movies by simply pressing the **●** (📹 movie-record) button.

- When no memory card is inserted (i.e., when using the camera's internal memory), **Movie options** (📖 81, 📷 38) is set to **VGA** **VGA (640×480)**. **720p** **HD 720p (1280×720)** cannot be selected.

## 1 Display the shooting screen.

- The icon for the selected movie option is displayed. The default setting is **720p** **HD 720p (1280×720)** (📖 81).
- When recording movies, the angle of view (i.e., the area visible in the frame) is narrower compared to that of still images.

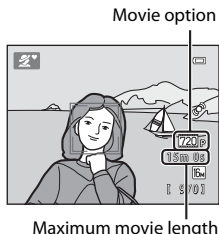

## 2 Press the **●** (📹 movie-record) button to start movie recording.

- The camera focuses on the subject in the center of the frame. Focus areas are not displayed during recording.
- When **720p** **HD 720p (1280×720)** is selected for **Movie options**, monitor display changes to an aspect ratio of 16:9 with movie recording.
- If **Photo info** in the **Monitor settings** (📖 86) in the setup menu is set to **Movie frame+auto info**, the area that will be visible in the movie can be confirmed before movie recording starts.
- [ ]** is displayed while saving to the internal memory.

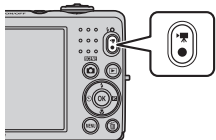

## 3 Press the **●** (📹 movie-record) button again to end recording.

## ✓ Notes About Saving Data

After taking a picture or recording a movie, the number of exposures remaining or the remaining recording time flashes while images or movies are being saved. **Do not open the battery-chamber/memory card slot cover** while images or movies are being saved. Image and movie data could be lost and the camera or memory card could be damaged.

## ✓ Notes About Movie Recording

- Memory cards with an SD Speed Class rating of 6 or faster are recommended when recording movies (📖 15). Movie recording may stop unexpectedly when memory cards with a lower Speed Class rating are used.
- The optical zoom magnification ratio cannot be changed once recording starts.
- Use the zoom control to operate digital zoom while recording movies. The zoom range is between the optical zoom magnification ratio before recording a movie and up to 4x.
- There may be some degradation in image quality when digital zoom is used. When recording ends, digital zoom turns off.
- The sounds of zoom control operation, autofocus lens drive movement (L26 only), and aperture operation when brightness changes may be recorded.
- Smear (👁️3) visible in the monitor when movie recording will be recorded with movies. Avoiding bright objects such as the sun, reflections of the sun, and electric lights is recommended.
- Depending on the distance to the subject or the amount of zoom applied, subjects with repeating patterns (fabrics, lattice windows, etc.) may have colored stripes (interference patterns, moiré, etc.) in them during movie recording and playback. This occurs when the pattern in the subject and the layout of the image sensor interfere with each other; it is not a malfunction.

## ✓ Camera Temperature

The camera may become warm when shooting movies for an extended period of time or when the camera is used in a hot area.

## ✓ Notes About Autofocus

Autofocus may not perform as expected (📖 28). Should this occur, try the following:

1. Set **Autofocus mode** in the movie menu to **AF-S Single AF** (default setting) before starting movie recording (L26 only; 📖 81, 📷39).
2. Frame another subject—positioned at the same distance from the camera as the intended subject—in the center of the frame, press the ● (📷 movie-record) button to start recording, and then modify the composition.



## Movie Options and Maximum Movie Length

Movie options (📖 81)	Internal memory (approx. 20 MB)	Memory card (4 GB) <sup>2</sup>
<del>720p</del> HD 720p (1280×720)	— <sup>1</sup>	15 min
<del>VGA</del> VGA (640×480)	12 s	45 min
<del>QVGA</del> QVGA (320×240)	45 s	3 h 10 min



All figures are approximate. The maximum movie length may vary depending on the make of the memory card, even among memory cards of the same capacity.

- <sup>1</sup> When using the internal memory, ~~720p~~ **HD 720p (1280×720)** cannot be selected.
- <sup>2</sup> The maximum file size for a single movie is 4 GB and the maximum movie length for a single movie is 29 minutes, even when there is sufficient free space on the memory card for longer recording. When recording a movie, the remaining recording time that is displayed is the amount of recording time available for one movie.

## Functions Available with Movie Recording



- The exposure compensation, white balance, and color options settings for the current shooting mode are also applied with movie recording. The tone that results from using scene mode (📖 35) is also applied to movies. When macro mode is enabled, movies of subjects closer to the camera can be recorded. Confirm settings before starting movie recording.
- The self-timer (📖 53) can be used. Set the self-timer and press the  (movie-record) button to start recording a movie after ten seconds.
- The flash will not fire.
- Press the **MENU** button to select the  (movie) tab and adjust movie menu settings before starting movie recording (📖 81).

## Changing Movie Recording Settings (the Movie Menu)

Enter shooting mode → MENU button →  tab →  button

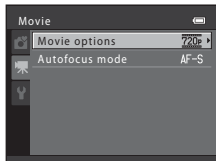
The following settings can be changed.



Option	Description	
Movie options	The following movie types are available: <del>720p</del> <b>HD 720p (1280×720)</b> , <b>VGA VGA (640×480)</b> , and <del>QVGA</del> <b>QVGA (320×240)</b> . When no memory card is inserted (i.e., when using the camera's internal memory), the default setting is <b>VGA VGA (640×480)</b> .	 38
Autofocus mode (L26 only)	When <b>AF-S Single AF</b> (default setting) is selected, focus is locked when movie recording begins. When <b>AF-F Full-time AF</b> is selected, the camera focuses continuously while recording. When <b>AF-F Full-time AF</b> is selected, the sound of the camera focusing may be heard in recorded movies. If you want to prevent the sound of the camera focusing from being recorded, select <b>AF-S Single AF</b> .	 39

## Playing Back Movies

Press the  button to enter playback mode.

Movies are indicated by the movie options icon ( 81).

Press the  button to play back movies.





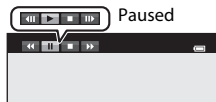















Movie options



### Functions Available During Playback

Playback controls are displayed at the top of the monitor.

Press the multi selector  or  to select a control. The operations described below are available.

Function	Icon	Description
Rewind		Hold down the  button to rewind the movie.
Advance		Hold down the  button to advance the movie.
Pause		Press the  button to pause playback. The following operations can be performed while playback is paused using the controls displayed at the top in the monitor.
		 Press the  button to rewind the movie. Hold down the  button for continuous rewinding.
		 Press the  button to advance the movie. Hold down the  button for continuous advancing.
		 Press the  button to resume playback.
End		Press the  button to return to full-frame playback mode.

## Adjusting volume

Rotate the zoom control to **T** or **W** (📖 2, 4) during playback.



Volume indicator

## Deleting movies

To delete a movie, select the desired movie in full-frame playback mode (📖 29) or thumbnail playback mode (📖 67) and press the  button (📖 31).

## Notes About Playing Back Movies

The camera is not able to play back movies recorded with another make or model of digital camera.





A series of ten horizontal dashed lines spanning the width of the page, intended for handwriting practice.

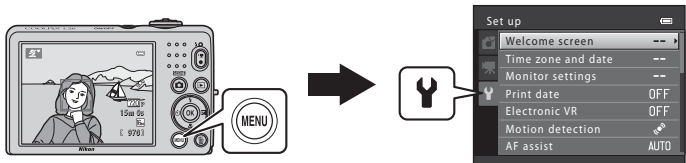

# General Camera Setup

This chapter describes the various settings that can be adjusted in the  setup menu.











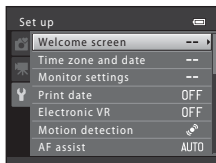

For further details about each setting, refer to “The Setup Menu” in the Reference Section (40).









## The Setup Menu

Press the **MENU** button → **Y** (setup) tab → **OK** button

The following settings can be changed in the setup menu by selecting the **Y** tab.



Option	Description	
Welcome screen	Allows you to select whether or not a welcome screen is displayed when the camera is turned on.	 40
Time zone and date	Allows you to set the camera clock and select the home and destination time zones.	 41
Monitor settings	Allows you to adjust photo information display and monitor brightness settings.	 45
Print date	Allows you to imprint the shooting date and time on images.	 47
Electronic VR	Allows you to select the electronic vibration reduction setting used when shooting still images.	 48
Motion detection	Allows you to set whether or not the camera automatically increases the shutter speed to reduce blurring caused by camera shake when motion is detected when shooting still images.	 50
AF assist (L26 only)	Allows you to enable and disable the AF-assist illuminator.	 51
Sound settings	Allows you to adjust sound settings.	 52
Auto off	Allows you to set the amount of time that passes before the monitor turns off to save power.	 53

Option	Description	
<b>Format memory/ Format card</b>	Allows you to format the internal memory or the memory card.	 54
<b>Language</b>	Allows you to change the camera's display language.	 55
<b>Video mode</b>	Allows you to adjust TV-connection settings.	 55
<b>Blink warning</b>	Allows you to set whether or not closed eyes are detected when taking pictures of people using face detection.	 56
<b>Eye-Fi upload</b>	Allows you to set whether or not the camera's Eye-Fi card (available from third-party manufacturers) sends images to your computer.	 58
<b>Reset all</b>	Allows you to reset the camera's settings to their default values.	 59
<b>Battery type</b>	Change this setting to match the type of batteries that are inserted in the camera.	 62
<b>Firmware version</b>	Allows you to confirm the camera's firmware version.	 62



A series of ten horizontal dashed lines spanning the width of the page, intended for handwriting practice.



# Reference Section

The Reference Section provides detailed information and hints about using the camera.

## Shooting

---

Using Panorama Assist ..... 2

## Playback

---

Editing Still Images ..... 5

Connecting the Camera to a TV (Viewing Images on a TV) ..... 12

Connecting the Camera to a Printer (Direct Print) ..... 14

## Menu

---

The Smart Portrait Menu ..... 22

The Shooting Menu (for (Auto) Mode) ..... 24

The Playback Menu ..... 29

The Movie Menu ..... 38

The Setup Menu ..... 40

## Additional Information

---









File and Folder Names ..... 63

Optional Accessories ..... 64

Error Messages ..... 65













## Using Panorama Assist

The camera focuses on the subject in the center of the frame. Use a tripod for the best results.

Enter shooting mode →  (shooting mode) button →  (second icon from the top\*)  
 →       (panorama assist) →  button

\* The icon of the last scene selected is displayed.

### 1 Use the multi selector to select the direction and press the button.

- Panorama direction icons are displayed to show the direction in which images will be joined. Select the direction in which images will be joined in the completed panorama; right () , left () , up () , or down () .
- The yellow panorama direction icon () is displayed for the current direction and the direction is fixed when the  button is pressed. The icon changes to the white fixed direction  icon.
- If necessary, apply flash mode ( 50), self-timer ( 53), macro mode ( 55), and exposure compensation ( 57) settings with this step.
- Press the  button again to select a different direction.



### 2 Frame the first portion of the panorama scene and take the first picture.

- About one third of the image will be displayed as translucent.



### 3 Take the next picture.

- Frame the next image so that one third of the frame overlaps the first image, and press the shutter-release button.
- Repeat this process until the necessary number of images has been taken to complete the scene.

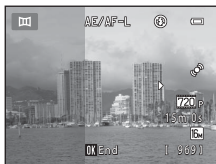

### 4 Press the **OK** button when shooting is complete.

- The camera returns to step 1.

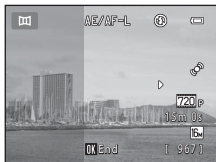

### **✓** Notes About Panorama Assist

- Flash mode, self-timer, macro mode, and exposure compensation settings cannot be adjusted after the first picture is taken. Images cannot be deleted, nor can zoom or **Image mode** settings (📖 60) be adjusted after the first picture has been taken.
- Shooting for the panorama series is terminated if the auto off function (🔋 53) initiates standby mode during shooting. Setting the time allowed to elapse before the auto off function is enabled to a longer setting is recommended.



## AE/AF-L Indicator

In **Panorama assist** scene mode, exposure, white balance, and focus for all images in a panorama are fixed at the values for the first image in each series.

When the first picture is taken, **AE/AF-L** is displayed to indicate that exposure, white balance, and focus are locked.



## Combining Images to Make a Panorama (Panorama Maker 6)

- Transfer images to a computer ( 74) and use Panorama Maker 6 to join them in a single panorama.
- Install Panorama Maker 6 from the included ViewNX 2 Installer CD-ROM ( 71).
- After installing Panorama Maker 6, start the software as explained below.  
Windows: Select the **Start** menu > **All Programs** > **ArcSoft Panorama Maker 6** > **Panorama Maker 6**  
Mac OS X: Open the **Applications** folder > double-click **Panorama Maker 6**
- For more information about using Panorama Maker 6, refer to the on-screen instructions and help information contained in Panorama Maker 6.

## More Information

File and Folder Names →  63



# Editing Still Images

## Editing Features

Use the camera to edit images and save them as separate files (063). The editing functions described below are available.

Editing function	Description
D-Lighting (067)	Create a copy of the current image with enhanced brightness and contrast, brightening dark portions of the image.
Skin softening (068)	Make the skin tones in human faces smoother.
Small picture (069)	Create a small copy of images suitable for use as e-mail attachments.
Crop (0610)	Crop a portion of the image. Use to zoom in on a subject or arrange a composition.

### Notes About Image Editing

- Images captured at an **Image mode** (60) setting of **4608x2592** for L26 and **3584x2016** for L25 cannot be edited.
- This camera cannot edit images captured with another make or model of digital camera.
- If no face is detected in an image, a copy cannot be created using the skin softening function (068).
- Edited copies created with this camera may not be displayed properly on another make or model of digital camera. It may also be impossible to transfer them to a computer using another make or model of digital camera.
- Editing functions are not available when there is not enough free space in the internal memory or on the memory card.



## Restrictions on Image Editing

When an edited copy is further modified with another editing function, check the following restrictions.

Editing function used	Editing functions that can be added
D-Lighting	The skin softening, small picture, or crop function can be added.
Skin softening	The D-Lighting, small picture, or crop function can be added.
Small picture Crop	Another editing function cannot be added.

- Copies created with editing functions cannot be further edited with the same function used to create them.
- When combining the small picture or crop function and another editing function, use the small picture and crop functions after other editing functions have been applied.
- You can apply skin softening to images that were captured using skin softening (22).

## Original and Edited Images

- Copies created with editing functions are not deleted if the original images are deleted. The original images are not deleted if copies created with editing functions are deleted.
- Edited copies are saved with the same shooting date and time as the original.
- Print order (29) and protect settings (33) do not remain effective in edited copies.

## D-Lighting: Enhancing Brightness and Contrast

Press the  button (playback mode) → MENU button →  D-Lighting →  button

Create a copy of the current image with enhanced brightness and contrast, brightening dark portions of an image.

Press the multi selector ▲ or ▼ to select **OK** and press the  button.

- The original version is displayed on the left and an example of the edited version is displayed on the right.
- A new, edited copy is saved as a separate image.
- Copies created with this feature are indicated by the  icon displayed during playback.

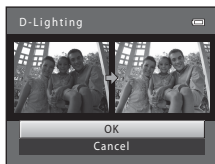



### More Information

File and Folder Names →  63

## Skin Softening: Softening Skin Tones

Press the  button (playback mode) → MENU button →  Skin softening →  button



The camera detects faces in images and creates a copy with softer facial skin tones.

**1** Press the multi selector  or  to select the degree of softening and press the  button.

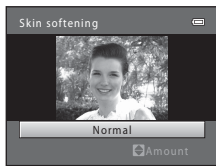
- The confirmation dialog is displayed with the face to which the effect was applied enlarged at the center of the monitor.
- To exit without saving the copy, press .



**2** Check the preview of the copy and press the  button.

- Skin tones in up to 12 faces, in the order of that closest to the center of the frame, are softened.
- If more than one face was processed, press the multi selector  or  to display a different face.
- Press the MENU button to adjust the degree of softening. The monitor display returns to that shown in step 1.
- Edited copies are saved as separate images, and  is displayed when you play them back.

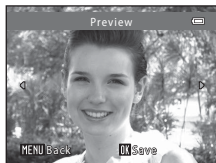

### Notes About Skin Softening

Depending upon the direction in which faces are looking, or the brightness of faces, the camera may be unable to accurately recognize faces, or the skin softening function may not perform as expected.



### More Information

File and Folder Names → 63

## **Small Picture: Reducing the Size of an Image**

Press the  button (playback mode) → MENU button →  Small picture →  button

Create a small copy of the current image.

- 1 Press the multi selector  or  to select the desired copy size and press the  button.

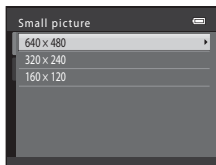

- 2 Select **Yes** and press the  button.

- A new, edited copy is saved as a separate image with a compression ratio of 1:16.
- The copy is displayed with a black frame.

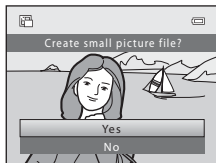



### **More Information**

File and Folder Names →  63

## **Crop: Creating a Cropped Copy**





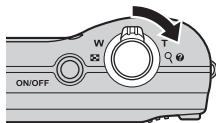

Create a copy containing only the portion visible in the monitor when **MENU**  is displayed with playback zoom ( 66) enabled.

- 1 Rotate the zoom control to **T** () in full-frame playback mode ( 29) to zoom in on the image.**

- To crop an image displayed in “tall” (portrait) orientation, zoom in on the image until the black bars displayed on the both sides of the monitor disappear. The cropped image will be displayed in landscape orientation. To crop the image in its current “tall” (portrait) orientation, first use the **Rotate image** option ( 35) to rotate the image so that it is displayed in landscape orientation. Next, enlarge the image for cropping, crop the image, and then rotate the cropped image back to “tall” (portrait) orientation.



- 2 Refine crop composition.**

- Rotate the zoom control to **T** () or **W** () to adjust the zoom ratio.
- Press the multi selector , , , or  to scroll the image so that only the portion to be copied is visible in the monitor.



- 3 Press the **MENU** button.**

- 4 Use the multi selector to select **Yes** and press the **OK** button.**

- A new, cropped copy is saved as a separate image.



## Image Size

As the area to be saved is reduced, the image size (pixels) of the cropped copy is also reduced. When the image size of the cropped copy is  $320 \times 240$  or  $160 \times 120$ , a black frame is displayed around the image, and the small picture icon  is displayed in the left of the monitor in playback mode.

## More Information

File and Folder Names → 63

# Connecting the Camera to a TV (Viewing Images on a TV)

Connect the camera to a TV using an optional audio/video cable (ⓐⓑ64) to play back images or movies on the TV.

**1** Turn off the camera.

**2** Connect the camera to the TV.

- Connect the yellow plug of the audio/video cable to the video-in jack and the white plug to the audio-in jack on the TV.

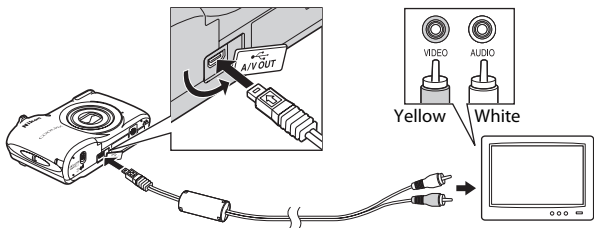

**3** Set the TV's input to external video input.

- See the documentation provided with your TV for details.

**4** Hold down the  button to turn on the camera.

- The camera enters playback mode and images are displayed on the TV.
- While connected to the TV, the camera monitor will remain off.





### **Notes About Connecting the Cable**

When connecting the cable, be sure that the camera connector is properly oriented. Do not use force when connecting the cable to the camera. When disconnecting the cable, do not pull the connector at an angle.

### **If the Images Are Not Displayed on the TV**

Be sure that the camera's video mode setting in the **Video mode** (55) under the setup menu conforms to the standard used by your TV.

## Connecting the Camera to a Printer (Direct Print)

Users of PictBridge-compatible (📷20) printers can connect the camera directly to the printer and print images without using a computer.

Follow the procedures below to print images.

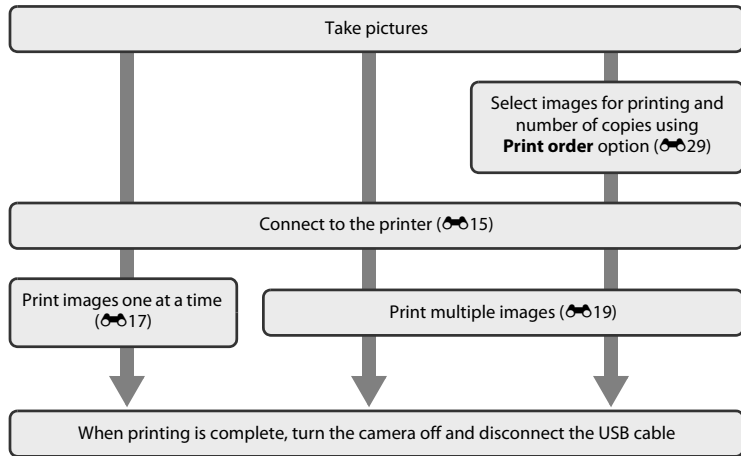

## Notes About Power Source

- When connecting the camera to a printer, use a fully charged battery to prevent the camera from turning off unexpectedly.
- If the AC Adapter EH-65A (available separately) is used, the camera can be powered from an electrical outlet. Do not use any other make or model of AC adapter as it may cause the camera to heat up or malfunction.

## Printing Images

In addition to printing images transferred to a computer from your personal printer and printing over a direct camera-to-printer connection, the following options are also available for printing images saved on the memory card:

- Inserting a memory card into a DPOF-compatible printer's card slot
- Taking a memory card to a digital photo lab

For printing using these methods, specify the images and the number of prints each to the memory card using the **Print order** option in the playback menu (29).

## Connecting the Camera to a Printer

---

- 1 Turn off the camera.
  - 2 Turn on the printer.
    - Check printer settings.
-

### 3 Connect the camera to the printer using the included USB cable.

- Be sure that connectors are properly oriented. Do not attempt to insert connectors at an angle, and do not use force when connecting or disconnecting the USB cable.

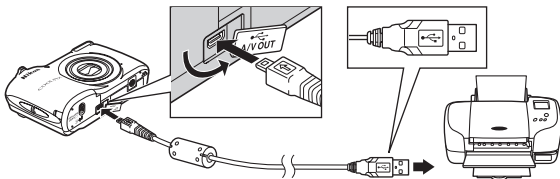

### 4 Turn on the camera.

- When properly connected, the **PictBridge** startup screen will be displayed in the camera monitor, followed by the **Print selection** screen.



## Printing Individual Images

After properly connecting the camera to the printer (🔌15), follow the procedures described below to print an image.

### 1 Use the multi selector to select the desired image and press the **OK** button.

- To make it easier to select images, rotate the zoom control to **W** (📷) to switch to 12-image thumbnail display mode. Rotate the zoom control to **T** (📺) to switch to full-frame playback mode.

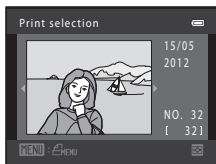

### 2 Select **Copies** and press the **OK** button.

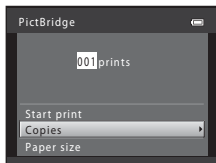

### 3 Select the desired number of copies (up to nine) and press the **OK** button.

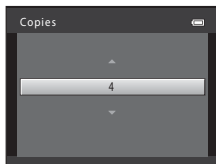

- 4 Select **Paper size** and press the **OK** button.

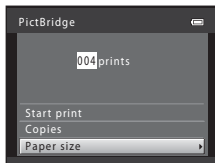

- 5 Select the desired paper size and press the **OK** button.

- To specify paper size using settings on the printer, select **Default** in the paper size option.

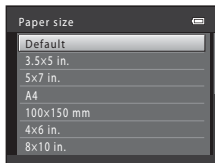

- 6 Select **Start print** and press the **OK** button.

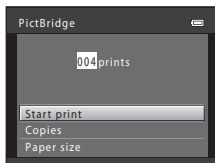

- 7 Printing begins.

- Monitor display returns to the print selection screen shown in step 1 when printing is complete.

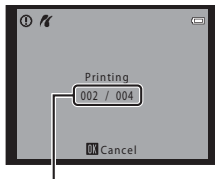

Current number of copies/  
total number of copies

## Printing Multiple Images

After properly connecting the camera to the printer (🔌15), follow the procedures described below to print multiple images.

**1** When the **Print selection** screen is displayed, press the **MENU** button.

**2** Use the multi selector to select **Paper size** and press the **OK** button.

- To exit the print menu, press the **MENU** button.

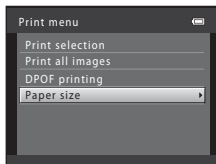

**3** Select the desired paper size and press the **OK** button.

- To specify paper size using settings on the printer, select **Default** in the paper size option.

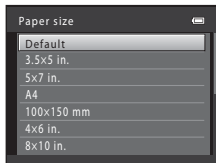

**4** Select **Print selection**, **Print all images**, or **DPOF printing** and press the **OK** button.

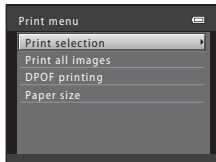

## Print selection

Select images (up to 99) and the number of copies (up to nine) of each.

- Press the multi selector ◀ or ▶ to select images, and press ▲ or ▼ to set the number of copies for each.
- Images selected for printing are indicated by the check mark (☑) and the numeral indicating the number of copies to be printed. If no copies have been specified for images, the selection is canceled.
- Rotate the zoom control to **T** (🔍) to switch to full-frame playback or **W** (🔲) to switch back to 12-thumbnail display.
- Press the **OK** button when setting is complete.
- When the screen shown on the right is displayed, select **Start print** and press the **OK** button to start printing. Select **Cancel** and press the **OK** button to return to the print menu.

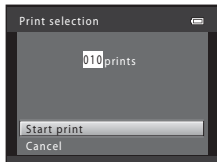

## Print all images

One copy each of all images saved in the internal memory, or on the memory card, is printed.

- When the screen shown on the right is displayed, select **Start print** and press the **OK** button to start printing. Select **Cancel** and press the **OK** button to return to the print menu.

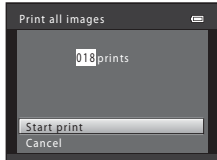



## DPOF printing

Print images for which a print order was created using the **Print order** option (🔑29).

- When the screen shown on the right is displayed, select **Start print** and press the **OK** button to start printing. Select **Cancel** and press the **OK** button to return to the print menu.
- To view the current print order, select **View images** and press the **OK** button. To print images, press the **OK** button again.

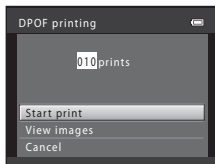

## 5 Printing begins.

- Monitor display returns to the print menu shown in step 2 when printing is complete.

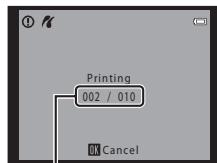

Current number of copies/  
total number of copies

## Paper Size

The camera supports the following paper sizes: **Default** (the default paper size for the printer connected to the camera), **3.5x5 in.**, **5x7 in.**, **100x150 mm**, **4x6 in.**, **8x10 in.**, **Letter**, **A3**, and **A4**. Only sizes supported by the printer will be displayed.

# The Smart Portrait Menu

- See “Changing the Image Size (Image Mode)” (📖 60) for information about **Image mode**.

## Skin Softening

Select smart portrait mode → MENU button → 🗨️ tab → Skin softening

Enable skin softening.

Option	Description
🗨️ On (default setting)	When the shutter is released, the camera detects one or more human faces (up to three), and processes the image to soften facial skin tones before saving the image.
OFF Off	Turns skin softening off.

The icon for the current setting is displayed in the monitor when the camera is in shooting mode (📖 6). No icon is displayed when **Off** is selected. The degree of skin softening effect cannot be confirmed on the subject on the shooting screen. Check the degree of skin softening performed in playback mode.

## Smile Timer

Select smart portrait mode → MENU button →  tab → Smile timer

The camera detects human faces and then automatically releases the shutter whenever a smile is detected.



Option	Description
 On (default setting)	Enables smile timer.
OFF Off	Turns the smile timer off.

The icon for the current setting is displayed in the monitor when the camera is in shooting mode ( 6). No icon is displayed when **Off** is selected.

## Blink Proof

Select smart portrait mode → MENU button →  tab → Blink proof

The camera automatically releases the shutter twice each time a picture is taken. Of the two shots, one in which the subject's eyes are open is saved.

Option	Description	
 On	Enables blink proof. Flash cannot be used when <b>On</b> is selected. If the camera saved an image in which the subjects eyes may have been closed, the dialog shown on the right is displayed for a few seconds.	
OFF Off (default setting)	Turns the blink proof off.	

The icon for the current setting is displayed in the monitor when the camera is in shooting mode ( 6). No icon is displayed when **Off** is selected.

## The Shooting Menu (for (Auto) Mode)









- See “Changing the Image Size (Image Mode)” ( 60) for information about **Image mode**.

### White Balance (Adjusting Hue)

Select  (auto) mode → MENU button →  tab → White balance

The color of light reflected from an object varies with the color of the light source. The human brain is able to adapt to changes in the color of the light source, with the result that white objects appear white whether seen in the shade, direct sunlight, or under incandescent lighting. Digital cameras can mimic this adjustment by processing images according to the color of the light source. This is known as “white balance.” For natural colors, select a white balance setting that matches the light source before shooting.

Although **Auto** (the default setting) can be used under most types of lighting, white balance can be adjusted to suit the sky conditions or light source and achieve more natural color tones in the image.

Option	Description
 <b>AUTO</b> Auto (default setting)	White balance is automatically adjusted to suit lighting conditions.
 <b>PRE</b> Preset manual	Useful when shooting under unusual lighting (  25).
 <b>Daylight</b>	White balance adjusted for direct sunlight.
 <b>Incandescent</b>	Use under incandescent lighting.
 <b>Fluorescent</b>	Use under fluorescent lighting.
 <b>Cloudy</b>	Use when taking pictures under overcast skies.
 <b>Flash</b>	Use with the flash.

The icon for the current setting is displayed in the monitor when the camera is in shooting mode ( 6). No icon is displayed when **Auto** is selected.

## Using Preset Manual

Preset manual is used with mixed lighting or to compensate for light sources with a strong color cast when the desired effect has not been achieved with white balance settings like **Auto** and **Incandescent** (for example, to make images shot under a lamp with a red shade look as though they had been shot under white light).

Use the procedure below to measure the white balance value under the lighting used during shooting.

**1** Prepare a white or gray-colored subject and place it under the lighting that will be used when shooting.

**2** Display the shooting menu (📖 48), use the multi selector to select **PRE Preset manual** in the **White balance** menu, and press the **OK** button.

- The camera zooms in to the position for measuring white balance.

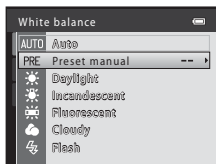

**3** Select **Measure**.

- To apply the most recently measured white balance value, select **Cancel** and press the **OK** button. The white balance setting will not be measured again and the most recently measured value will be set.

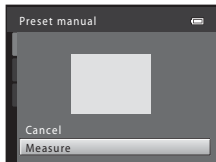

- 4 Frame the reference object in the measuring window.

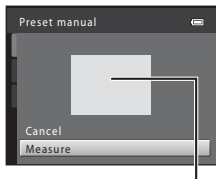

Measuring window

- 5 Press the **OK** button to measure a value for preset manual.
- The shutter is released and the new white-balance value is set. No image is saved.



**✓ Notes About White Balance**

- Some settings cannot be used with other functions (📖 62).
- Set the flash to **☹** (off) when white balance is set to any setting other than **Auto** and **Flash** (📖 50).







**✓ Notes About Preset Manual**

A value for flash lighting cannot be measured with **Preset manual**. When shooting using the flash, set **White balance** to **Auto** or **Flash**.

# Continuous Shooting

Select  (auto) mode → MENU button →  tab → Continuous

Change settings to continuous or BSS (best shot selector).

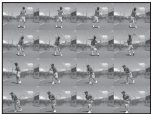
Option	Description
 Single (default setting)	One picture is taken each time the shutter-release button is pressed.
 Continuous	While the shutter-release button is held all the way down, the camera captures up to four images at a rate of about 1.2 frames per second (fps) when <b>Image mode</b> is set to  <b>4608×3456</b> (for L26) or  <b>3648×2736</b> (for L25).
<b>BSS</b> BSS (best shot selector)	The “best shot selector” is recommended when shooting with the flash off or the camera zoomed in, or in other situations in which inadvertent motion can result in blurred images. When BSS is on, the camera takes up to ten pictures while the shutter-release button is held down. The sharpest image in the series is automatically selected and saved. <ul style="list-style-type: none"><li>• <b>BSS</b> is best suited to shooting subjects that are not moving. When shooting moving subjects or when the composition of the picture changes while shooting, the desired results may not be achieved.</li></ul>
 Multi-shot 16	Each time the shutter-release button is pressed, the camera takes 16 shots at a rate of about 30 fps and arranges them in a single image. <ul style="list-style-type: none"><li>• <b>Image mode</b> is fixed at  (image size: 2560 × 1920 pixels).</li><li>• Digital zoom cannot be used.</li></ul> 

The icon for the current setting is displayed in the monitor when the camera is in shooting mode ( 6). No icon is displayed when **Single** is selected.

## ✓ Notes About Continuous Shooting

- When **Continuous**, **BSS**, or **Multi-shot 16** is selected, flash cannot be used. Focus, exposure, and white balance are fixed at the values determined with the first image in each series.
- The frame rate with continuous shooting may vary depending upon the current image mode setting, the memory card used, or shooting condition.
- Some settings cannot be used with other functions (📖 62).

## ✓ Notes About Multi-shot 16

Smear (👁️-3) visible in the monitor when shooting with **Multi-shot 16** enabled will be saved with images. Avoiding bright objects such as the sun, reflections of the sun, and electric lights when shooting with **Multi-shot 16** enabled is recommended.

---

## Color Options

Select 📷 (auto) mode → MENU button → 📷 tab → Color options

Make colors more vivid or save images in monochrome.

Option	Description
👁️ Standard color (default setting)	Use for images exhibiting natural color.
👁️ Vivid color	Use to achieve a vivid, "photoprint" effect.
👁️ Black-and-white	Save images in black-and-white.
👁️ Sepia	Save images in sepia tones.
👁️ Cyanotype	Save images in cyan-blue monochrome.

The icon for the current setting is displayed in the monitor when the camera is in shooting mode (📖 6). When **Standard color** is selected, no icon is displayed. Color tones shown in the monitor during shooting change according to the selected color option.

## ✓ Notes About Color Options

Some settings cannot be used with other functions (📖 62).



# The Playback Menu

- See “Editing Still Images” (📷5) for information about image editing features.

## 🖨️ Print Order (Creating a DPOF Print Order)

Press the ▶️ button (playback mode) → MENU button → Playback menu → 🖨️ Print order

When printing images saved on the memory card using any of the following methods, the **Print order** option in the playback menu is used to create digital “print orders.”

- Inserting the memory card into a DPOF-compatible (📷20) printer’s card slot.
- Taking the memory card to a digital photo lab.
- Connecting the camera to a PictBridge-compatible (📷20) printer (📷14). A print order can also be created for images saved in the internal memory if the memory card is removed from the camera.

- 1 Select **Select images** and press the Ⓞ button.

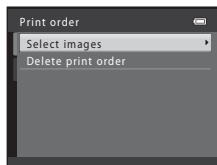

## 2 Select images (up to 99) and the number of copies (up to nine) of each.

- Press the multi selector ◀ or ▶ to select images, and press ▲ or ▼ to set the number of copies for each.
- Images selected for printing are indicated by the check mark icon and the numeral indicating the number of copies to be printed. If no copies have been specified for images, the selection is canceled.
- Rotate the zoom control to **T** (🔍) to switch to full-frame playback. Rotate the zoom control to **W** (🖼️) to switch back to 12-thumbnail display.
- Press the **OK** button when setting is complete.



## 3 Select whether or not to print shooting date and shooting information.

- Select **Date** and press the **OK** button to print the shooting date on all images in the print order.
- Select **Info** and press the **OK** button to print shooting information (shutter speed and aperture value) on all images in the print order.
- Select **Done** and press the **OK** button to complete the print order.

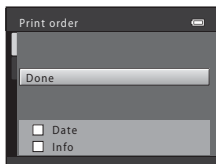

Images selected for printing are indicated by the 🖨️ icon during playback.

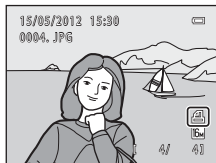

## ✓ Notes About Printing Shooting Date and Shooting Information

When the **Date** and **Info** settings are enabled in the print order option, shooting date and shooting information are printed on images when a DPOF-compatible printer (🔗20) that supports printing of shooting date and shooting information is used.

- Shooting information cannot be printed when the camera is connected to a DPOF-compatible printer via the included USB cable (🔗21).
- Note that **Date** and **Info** settings are reset each time the **Print order** option is displayed.
- The date printed is that saved when the image was captured. Changing the camera's date using the **Date and time** or **Time zone** in the **Time zone and date** option in the setup menu after an image has been captured has no effect on the date printed on the image.



## ✎ Canceling Existing Print Order

Select **Delete print order** in step 1 (🔗29) of “🖨 Print Order (Creating a DPOF Print Order)” and press the **OK** button to remove print marking from all images and cancel the print order.

## ✎ Print Date

When shooting date and time are imprinted on images using the **Print date** option (🔗47) in the setup menu, images are saved with shooting date and time imprinted on the image when they are captured. Images with the date imprinted on them can be printed from printers that do not support printing of the date on images.

Only the date and time imprinted on images with the print date option will be printed, even if the **Print order** date option is enabled.

## Slide Show

Press the  button (playback mode) → MENU button → Playback menu →  Slide show



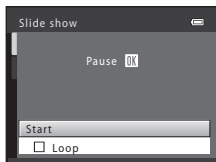

Play back images, saved in the internal memory or on a memory card, one by one in an automated “slide show.”

### 1 Use the multi selector to select **Start** and press the **OK** button.

- To repeat the slide show automatically, select **Loop** and press the **OK** button before selecting **Start**. The check mark (✓) will be added to the loop option when enabled.





### 2 The slide show begins.

- While the slide show is in progress, press the multi selector  or  to display the next image or  or  to display the previous image. Hold down the corresponding button to fast forward or rewind.
- To end or pause the slide show, press the **OK** button.



### 3 End the slide show or restart it.

- The display at right appears when the last slide is displayed or the show is paused. Highlight  and press **OK** to return to Step 1, or select  to restart the show.



### Notes About Slide Show

- Only the first frame of movies included in a slide show is displayed.
- The maximum playback time is up to about 30 minutes even if **Loop** is enabled (53).

## Protect



Press the  button (playback mode) → MENU button → Playback menu →  Protect

Protects selected images from accidental deletion.

Select images to protect or cancel protection for previously protected images from the image selection screen.

→ “The Image Selection Screen” (34)

Note that formatting the camera’s internal memory or the memory card will permanently delete protected files (54).

Protected images are indicated by the  icon during playback ( 8).

## The Image Selection Screen

When using one of the following features, a screen like that shown on the right is displayed when selecting images.

- Print order > **Select images** (🔍33)
- Protect (🔍33)
- Rotate image (🔍35)
- Copy > **Selected images** (🔍36)
- Welcome screen > **Select an image** (🔍40)
- Delete image > **Erase selected images** (📖 31)



Follow the procedures described below to select the images.

### 1 Press the multi selector ◀ or ▶ to select an image.

- Rotate the zoom control (📖 2, 4) to **T** (🔍) to switch to full-frame playback or **W** (📺) to switch back to 12-thumbnail display.
- Only one image can be selected for **Rotate image** and **Welcome screen**. Proceed to step 3.



### 2 Press ▲ or ▼ to select or deselect (or to specify the number of copies).



- When an image is selected, a check mark (✔) is displayed with the image. Repeat steps 1 and 2 to select additional images.





### 3 Press the (OK) button to apply image selection.

- When **Selected images** is selected, a confirmation dialog is displayed. Follow the instructions displayed in the monitor.

## Rotate Image

Press the  button (playback mode) → MENU button → Playback menu →  Rotate image

Specify the orientation in which saved images are displayed during playback. Still images can be rotated 90 degrees clockwise or 90 degrees counterclockwise.

Select an image from the image selection screen (34). When the Rotate image screen is displayed, press the multi selector  or  to rotate the image 90 degrees.

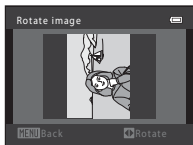

Rotate 90 degrees  
counterclockwise

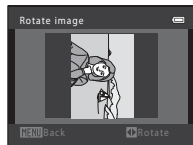

Rotate 90 degrees  
clockwise

Press the  button to finalize display orientation, and save orientation information with the image.

### Notes About Image Rotation

The camera cannot rotate images captured with another make or model of digital camera.

## Copy (Copy Between Internal Memory and Memory Card)

Press the  button (playback mode) → MENU button → Playback menu →  Copy

Copy images between the internal memory and a memory card.

**1** Use the multi selector to select a destination option to which images are copied and press the .

- **Camera to card:** Copy images from internal memory to memory card.
- **Card to camera:** Copy images from memory card to internal memory.

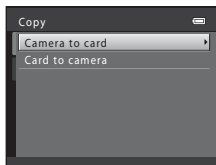

**2** Select a copy option and press the .

- **Selected images:** Copy images selected from the image selection screen (34).
- **All images:** Copy all images.

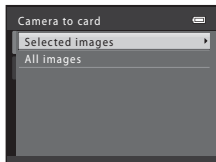



## Notes About Copying Images

- JPEG- and AVI-format files can be copied.
- Operation is not guaranteed with images captured with another make of camera or that have been modified on a computer.
- When copying images for which **Print order** (0629) options are enabled, the print order settings are not copied. However, when copying images for which **Protect** (0633) is enabled, the protect setting is copied.

## If “Memory contains no images.” Is Displayed

If a memory card that contains no images is inserted into the camera, **Memory contains no images.** will be displayed when the camera is switched to playback mode. Press the **MENU** button to display the copy options screen, and copy the images saved in the camera’s internal memory to the memory card.

## More Information

File and Folder Names → 063



# The Movie Menu

## Movie Options

Enter shooting mode → MENU button →  tab → Movie options

Select the desired movie option to record.

Larger image sizes and faster movie bitrates mean greater image quality and larger movie file sizes.

Option	Description
 HD 720p (1280×720) (default setting)*	Movies with an aspect ratio of 16:9 are recorded. <ul style="list-style-type: none"><li>• Movie bitrate: Approx. 30 Mbps</li></ul>
 VGA (640×480)	Movies with an aspect ratio of 4:3 are recorded. <ul style="list-style-type: none"><li>• Movie bitrate: Approx. 10.7 Mbps</li></ul>
 QVGA (320×240)	Movie with an aspect ratio of 4:3 are recorded. <ul style="list-style-type: none"><li>• Movie bitrate: Approx. 2.7 Mbps</li></ul>

\* When no memory card is inserted (i.e., when using the camera's internal memory), the setting is

 **VGA (640×480).**

- The movie bitrate is the volume of movie data recorded per second.
- The frame rate is approximately 30 frames per second for all options.
- Movie Options and Maximum Movie Length →  80



### More Information

File and Folder Names →  63

## Autofocus Mode (L26 Only)

Enter shooting mode → MENU button →  tab → Autofocus mode

Select how the camera focuses in movie mode.







Option	Description
<b>AF-S</b> Single AF (default setting)	Focus is locked when the ● (  ) button is pressed to start recording. Select this option when the distance between the camera and the subject will remain fairly consistent.
<b>AF-F</b> Full-time AF	Camera focuses continuously. Select this option when the distance between the camera and subject will change significantly during recording. The sound of the camera focusing may be heard in the recorded movie. Use of <b>Single AF</b> is recommended to prevent the sound of the camera focusing from interfering with recording.

# The Setup Menu

## Welcome Screen

MENU button →  tab → Welcome screen

Configure the welcome screen that is displayed when you turn on the camera.

Option	Description
None (default setting)	The camera enters shooting or playback mode without displaying the welcome screen.
COOLPIX	The camera displays a welcome screen and enters shooting or playback mode.
Select an image	Displays an image selected for the welcome screen. When the image selection screen is displayed, select an image (  34) and press the  button. <ul style="list-style-type: none"><li>As the selected image is saved by the camera, it will be displayed when the camera is turned on even if the original image is deleted.</li><li>Images captured at an <b>Image mode</b> ( 60) setting of  <b>4608×2592</b> for L26 and  <b>3584×2016</b> for L25, and copies created at a size smaller than 320 × 240 using the small picture (9) or crop (10) function, cannot be selected.</li></ul>

## Time Zone and Date

MENU button → 🗨️ tab → Time zone and date

Set the camera clock.

Option	Description
Date and time	<p>Allows you to set the camera's clock to the current date and time. Use the multi selector to set each item displayed on the screen.</p> <ul style="list-style-type: none"><li>• Select an item: Press ▶ or ◀ (changes between <b>D</b>, <b>M</b>, <b>Y</b>, <b>hour</b>, <b>minute</b>).</li><li>• Edit the highlighted item: Press ▲ or ▼.</li><li>• Apply the setting: Select the <b>minute</b> setting and press the Ⓞ button.</li></ul>
Date format	<p>The available date formats are <b>Year/Month/Day</b>, <b>Month/Day/Year</b>, and <b>Day/Month/Year</b>.</p>
Time zone	<p>🏠 <b>Home time zone</b> can be specified and daylight saving time can be enabled or disabled. When the travel destination (📍) is selected, the time difference (🕒44) between the travel destination and the home time zone (🏠) is automatically calculated and the date and time in the selected region are saved. This can be useful when travelling.</p>

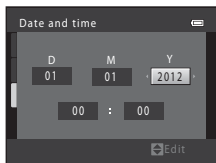

## Selecting the Travel Destination Time Zone

- 1 Use the multi selector to select **Time zone** and press the **OK** button.

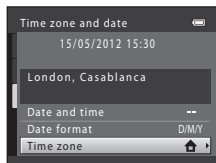

- 2 Select **Travel destination** and press the **OK** button.

- The date and time displayed in the monitor changes according to the region currently selected.

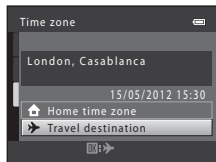

- 3 Press **▶**.

- The travel destination screen is displayed.

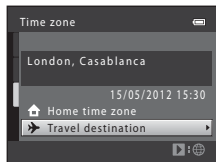

## 4 Press ◀ or ▶ to select the travel destination time zone.

- If daylight saving time is in effect, press ▲ to enable daylight saving time function. ☀ is displayed at the top of the monitor and the camera clock is advanced one hour. Press ▼ to disable the daylight saving time function.
- Press the OK button to apply the travel destination time zone.
- While the travel destination time zone is selected, the ⏪ icon will be displayed in the monitor when the camera is in shooting mode.

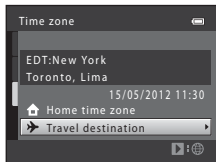
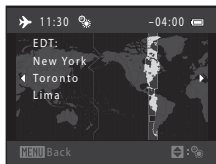

### Home Time Zone

- To switch to the home time zone, select **Home time zone** in step 2 and press the OK button.
- To change the home time zone, select **Home time zone** in step 2, and complete steps 3 and 4.

### Daylight Saving Time

When daylight saving time starts or ends, turn the daylight saving time function on or off from the time zone selection screen displayed in step 4.

### Imprinting Date on Images

Enable date imprint from the **Print date** option (47) in the setup menu after the date and time have been set. When the **Print date** option is enabled, images will be saved with shooting date imprinted on them.

## Time Zones

The camera supports the time zones listed below.

For time zones not listed below, set the camera clock to local time from the **Date and time** option.

UTC +/-	Location	UTC +/-	Location
-11	Midway, Samoa	+1	Madrid, Paris, Berlin
-10	Hawaii, Tahiti	+2	Athens, Helsinki, Ankara
-9	Alaska, Anchorage	+3	Moscow, Nairobi, Riyadh, Kuwait, Manama
-8	PST (PDT): Los Angeles, Seattle, Vancouver	+4	Abu Dhabi, Dubai
-7	MST (MDT): Denver, Phoenix	+5	Islamabad, Karachi
-6	CST (CDT): Chicago, Houston, Mexico City	+5.5	New Delhi
-5	EST (EDT): New York, Toronto, Lima	+6	Colombo, Dhaka
-4.5	Caracas	+7	Bangkok, Jakarta
-4	Manaus	+8	Beijing, Hong Kong, Singapore
-3	Buenos Aires, Sao Paulo	+9	Tokyo, Seoul
-2	Fernando de Noronha	+10	Sydney, Guam
-1	Azores	+11	New Caledonia
±0	London, Casablanca	+12	Auckland, Fiji



# Monitor Settings



MENU button →  tab → Monitor settings

Set the options below.

Option	Description
Photo info	Select information displayed in the monitor during shooting and playback.
Brightness	Select from five settings for monitor brightness. The default setting is <b>3</b> .

## Photo Info

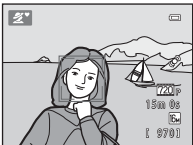
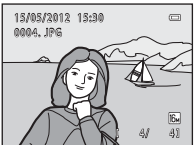
Select whether or not the photo information is displayed in the monitor.

	Shooting mode	Playback mode
Show info	 The monitor shows a woman's face in the foreground and a landscape with mountains and a sailboat in the background. Overlaid information includes a battery icon, a signal strength icon, a camera icon, '22.0p', '15m 0s', a photo icon, and 'L 9701'.	 The monitor shows the same scene as the shooting mode. Overlaid information includes the date and time '15/05/2012 15:30', the file name '0004.JPG', a photo icon, and '4/ 41'.
Auto info (default setting)	The same information as in <b>Show info</b> is displayed. If no operations are performed after a few seconds, the display will be the same as <b>Hide info</b> . The information is displayed again when an operation is performed.	
Hide info	 The monitor shows the same scene as the shooting mode, but without any overlaid information.	 The monitor shows the same scene as the playback mode, but without any overlaid information.

## Shooting mode

## Playback mode

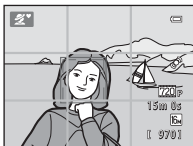
Framing  
grid+auto info

In addition to information shown with **Auto info** above, a framing grid is displayed to help frame pictures. It is not displayed when recording movies.

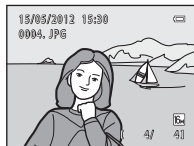

The same information as in **Auto info** is displayed.

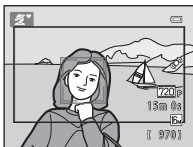
Movie  
frame+auto info

In addition to information shown with **Auto info** above, a frame is displayed before recording begins that represents the area that will be captured when recording movies. It is not displayed when recording movies.



The same information as in **Auto info** is displayed.

# Print Date (Imprinting Date and Time)

MENU button → Y tab → Print date

The shooting date and time can be imprinted on the images when shooting, allowing the information to be printed even from printers that do not support date printing (📷31).



Option	Description
 Date	Date is imprinted on images.
 Date and time	Date and time are imprinted on images.
<b>OFF</b> Off (default setting)	Date and time are not imprinted on images.

The icon for the current setting is displayed in the monitor when the camera is in shooting mode (📖6). No icon is displayed when **Off** is selected.

## ✔ Notes About Print Date

- Imprinted dates form a permanent part of image data and cannot be deleted. The date and time cannot be imprinted on images after they have been captured.
- The date cannot be imprinted in the following situations:
  - When using the **Panorama assist** scene mode or when **Pet portrait** is set to **Continuous**
  - When shooting movies
- Dates imprinted at an **Image mode** setting (📖60) of **VGA 640×480** may be difficult to read. Select an **Image mode** setting of **2M 1600×1200** or larger when using print date.
- The date is saved using the format selected in the setup menu's **Time zone and date** option (📖16, 📷41).



## 📎 Print Date and Print Order



When printing with a DPOF-compatible printer that can print the shooting date and shooting information, you can use the **Print order** option (📷29) to print this information in images, even if the **Print date** function was set to **Off** at the time of shooting.

## Electronic VR

MENU button →  tab → Electronic VR

Select the electronic VR (vibration reduction) setting used when shooting still images.

Option	Description
 <b>Auto</b>	In the following conditions, electronic VR is applied and the effects of camera shake are reduced when shooting still images: <ul style="list-style-type: none"><li>• When the flash mode is set to  (off) or  (slow sync)</li><li>• When the shutter speed is slow</li><li>• When the <b>Continuous</b> setting is set to <b>Single</b></li><li>• When the subject is dark</li></ul>
<b>OFF</b> Off (default setting)	Electronic VR is disabled.

When **Auto** is selected,  appears on the monitor ( 6), and electronic VR is applied depending on shooting conditions.











## Notes About Electronic Vibration Reduction

- Electronic VR is disabled while the flash is used, except when using slow sync mode. Note that Electronic VR is disabled even when flash mode is slow sync with red-eye reduction (📖 59).
- If the exposure period exceeds a certain period of time, electronic VR will not function.
- Electronic VR cannot be used if **Blink proof** (📖 23) in smart portrait mode is set to **On**.
- Electronic VR cannot be used when using the following scene modes.
  - Sports (📖 37)
  - Night portrait (📖 37)
  - Dusk/dawn (📖 38)
  - Night landscape (📖 39)
  - Museum (📖 40)
  - Fireworks show (📖 40)
  - Backlighting (📖 40)
  - When **Pet portrait** (📖 42) is set to **Continuous**
- The effectiveness of electronic VR decreases as camera shake increases.
- The images captured may become somewhat grainy.

# Motion Detection

MENU button →  tab → Motion detection

Enable motion detection to reduce the effects of subject movement and camera shake when shooting still images.

Option	Description
 Auto (default setting)	When the camera detects subject movement or camera shake, the ISO sensitivity and shutter speed are automatically increased to reduce blurring. However, motion detection does not function in the following situations: <ul style="list-style-type: none"><li>• When the flash fires</li><li>• In  (auto) mode, when <b>Continuous</b> is set to <b>Multi-shot 16</b> ()</li><li>• In the following scene modes: <b>Sports</b> () 37, <b>Night portrait</b> () 37, <b>Dusk/dawn</b> () 38, <b>Night landscape</b> () 39, <b>Museum</b> () 40, <b>Fireworks show</b> () 40, <b>Backlighting</b> () 40, and <b>Pet portrait</b> () 42</li></ul>
OFF Off	Motion detection is disabled.

The icon for the current setting is displayed in the monitor when the camera is in shooting mode () 6. When the camera detects camera shake or subject movement, it increases shutter speed and the motion detection icon turns green. No icon is displayed when **Off** is selected.



## Notes About Motion Detection

- Motion detection may be unable to completely eliminate the effects of subject movement and camera shake in some situations.
- Motion detection may not function if the subject exhibits significant movement or is too dark.
- The images captured using motion detection may be somewhat “grainy” in appearance.

## AF Assist (L26 Only)

MENU button →  tab → AF assist



Enable or disable AF-assist illuminator, which assists autofocus operation when the subject is dimly lit.

Option	Description
Auto (default setting)	AF-assist illuminator will be used to assist the focus operation when the subject is dimly lit. The illuminator has a range of about 1.9 m (6 ft 2 in.) at the maximum wide-angle position and about 1.1 m (3 ft 7 in.) at the maximum telephoto position. Note that for some scene modes (such as <b>Museum</b> (  40) and <b>Pet portrait</b> (  42)), the AF-assist illuminator may not light even when <b>Auto</b> is selected.
Off	AF-assist illuminator does not light. The camera may be unable to focus under dim lighting.

## Sound Settings

MENU button →  tab → Sound settings

Adjust the following sound settings.

Option	Description
Button sound	Select <b>On</b> (default setting) or <b>Off</b> . When <b>On</b> is selected, a beep will sound once when operations are completed successfully, twice when the camera acquires focus on the subject, and three times when an error is detected. Start-up sound will also play when the camera is turned on.
Shutter sound	Select <b>On</b> (default setting) or <b>Off</b> . Even when set to <b>On</b> , the shutter sound is not heard in the following situations: <ul style="list-style-type: none"><li>• When using <b>Continuous</b>, <b>BSS</b>, or <b>Multi-shot 16</b> ( 27)</li><li>• When using <b>Sports</b> ( 37) or <b>Museum</b> ( 40)</li><li>• When shooting movies</li></ul>

### Notes About Sound Settings

Button sounds and the shutter sound are not heard when using the **Pet portrait** scene mode.



## Auto Off

MENU button →  tab → Auto off



If no operations are performed for a specified amount of time, the monitor turns off and the camera enters standby mode to save power ( 22).

This setting determines the amount of time that passes before the camera enters standby mode.

Option	Description
Auto off	You can select <b>30 s</b> (default setting), <b>1 min</b> , <b>5 min</b> , or <b>30 min</b> .
Sleep mode	If <b>On</b> (default setting) is selected, the camera will enter standby mode when there is no change in the brightness of the subject, even before the time selected in the auto off menu has elapsed. The camera will enter sleep mode after 30 seconds when <b>Auto off</b> is set to <b>1 min</b> or less, or after 1 minute when <b>Auto off</b> is set to <b>5 min</b> or more.



### When the Monitor Has Turned Off to Save Power

- When the camera is in standby mode, the power-on lamp flashes.
- If no operations are performed for approximately another three minutes, the camera will turn off automatically.
- When the power-on lamp is flashing, pressing any of the following buttons will turn the monitor back on:
  - Power switch, shutter-release button,  button,  button, or  (movie-record) button



### Notes About Auto Off

- The time that passes before the camera enters standby mode is fixed in the following situations:
  - When a menu is displayed: 3 minutes
  - During slide show playback: Up to 30 minutes
- The camera will not enter standby mode while the Eye-Fi card is uploading images.

## Format Memory/Format Card

MENU button →  tab → Format memory/Format card

Use this option to format the internal memory or a memory card.

**Formatting the internal memory or memory cards permanently deletes all data.**

**Data that has been deleted cannot be recovered.** Be sure to transfer important data to a computer before formatting.

### Formatting the Internal Memory

To format the internal memory, remove the memory card from the camera. The **Format memory** option is displayed in the setup menu.

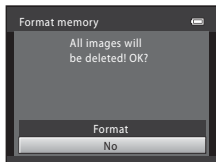

### Formatting Memory Cards

When a memory card is inserted in the camera, the **Format card** option is displayed in the setup menu.

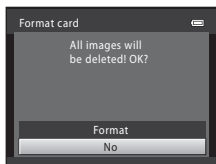

#### **Notes About Formatting Internal Memory and Memory Cards**

- Do not turn the camera off or open the battery-chamber/memory card slot cover during formatting.
- The first time you insert a memory card that has been used in another device into this camera, be sure to format it with this camera.

## Language

MENU button →  tab → Language

Select one of 29 languages for display of camera menus and messages.

<b>Čeština</b>	Czech
<b>Dansk</b>	Danish
<b>Deutsch</b>	German
<b>English</b>	(default setting)
<b>Español</b>	Spanish
<b>Ελληνικά</b>	Greek
<b>Français</b>	French
<b>Indonesia</b>	Indonesian
<b>Italiano</b>	Italian
<b>Magyar</b>	Hungarian
<b>Nederlands</b>	Dutch
<b>Norsk</b>	Norwegian
<b>Polski</b>	Polish
<b>Português (BR)</b>	Brazilian Portuguese
<b>Português (PT)</b>	European Portuguese

<b>Русский</b>	Russian
<b>Română</b>	Romanian
<b>Suomi</b>	Finnish
<b>Svenska</b>	Swedish
<b>Tiếng Việt</b>	Vietnamese
<b>Türkçe</b>	Turkish
<b>Українська</b>	Ukrainian
<b>عربي</b>	Arabic
<b>简体中文</b>	Simplified Chinese
<b>繁體中文</b>	Traditional Chinese
<b>日本語</b>	Japanese
<b>한글</b>	Korean
<b>ภาษาไทย</b>	Thai
<b>हिन्दी</b>	Hindi

## Video Mode

MENU button →  tab → Video mode

Adjust settings for connection to a TV.

Select from **NTSC** and **PAL**.

## Blink Warning

MENU button →  tab → Blink warning

Select whether or not the camera detects human subjects that have blinked using face detection ( 63) when shooting in the following modes:

-  (easy auto) mode
- **Portrait** ( 36) or **Night portrait** ( 37) scene mode

Option	Description
On	When the camera detects that one or more human subjects may have blinked in an image captured using face detection, the <b>Did someone blink?</b> screen is displayed in the monitor. The face of the human subject that may have blinked when the shutter was released is framed by a yellow border. Should this occur, check the image and determine whether or not another image should be captured (  57).
Off (default setting)	Blink warning is disabled.

## The Blink Warning Screen

When the **Did someone blink?** screen shown on the right is displayed in the monitor, the operations described below are available.

If no operations are performed within a few seconds, the camera automatically returns to shooting mode.





Function	Description
Enlarge the detected face that blinked	Rotate the zoom control to <b>T</b> (Q).
Switch to full-frame playback	Rotate the zoom control to <b>W</b> (R).
Select the face to be displayed	While zoomed in, press the multi selector ◀ or ▶ to switch to another face.
Delete the image	Press the  button.
Switch to shooting mode	Press the  button or the shutter-release button.

# Eye-Fi Upload

MENU button →  tab → Eye-Fi upload

Set whether or not the camera's Eye-Fi card (available from third-party manufacturers) sends images to your computer.





Option	Description
 Enable	Images created with this camera will be uploaded to the pre-determined computer.
 Disable (default setting)	Images will not be uploaded.

## Notes About Eye-Fi Cards

- Note that images will not be uploaded if signal strength is insufficient even if **Enable** is selected.
- When using the camera in an area where wireless signal output is not permitted, set this feature to **Disable**.
- Refer to the instruction manual of your Eye-Fi card for more information. In the event of malfunction, contact the card manufacturer.
- The camera can be used to turn Eye-Fi cards on and off, but may not support other Eye-Fi functions.
- The camera is not compatible with the Endless Memory function. When it is set on a computer, disable the function. If the Endless Memory function is enabled, the number of pictures taken may not be displayed correctly.
- The Eye-Fi upload feature is intended for use only in the country of purchase. Before using it in other countries, refer to laws and regulations of that country.
- When this setting is set to **Enable**, the battery will be drained faster than normal.

## Eye-Fi Upload Indicator

The upload status of the Eye-Fi card in the camera can be confirmed on the monitor ( 6, 8).

- : **Eye-Fi upload** is set to **Disable**.
-  (lights): Eye-Fi upload enabled; waiting for image upload.
-  (flashes): Eye-Fi upload enabled; uploading images.
- : Eye-Fi upload enabled but no images available for upload.
- : An error occurred. The camera cannot control the Eye-Fi card.

## Supported Eye-Fi Cards

As of November, 2011, the following Eye-Fi cards can be used. Be sure that Eye-Fi card firmware has been updated to the latest version.

- Eye-Fi Connect X2 SDHC 4GB
- Eye-Fi Mobile X2 SDHC 8GB
- Eye-Fi Pro X2 SDHC 8GB





---

## Reset All





MENU button →  tab → Reset all

When **Reset** is selected, the camera's settings will be restored to their default values.

### Basic Shooting Functions

Option	Default value
Flash mode (  50)	Auto
Self-timer (  53)	Off
Macro mode (  55)	Off
Exposure compensation (  57)	0.0

### Scene Mode

Option	Default value
Scene mode setting in the shooting-mode selection menu (  35)	Portrait
Hue adjustment in Food mode (  39)	Center
Continuous shooting in pet portrait mode (  42)	Continuous
Pet portrait auto release in pet portrait mode (  42)	On

## Smart Portrait Menu

Option	Default value
Skin softening (📷22)	On
Smile timer (📷23)	On
Blink proof (📷23)	Off

## Shooting Menu

Option	Default value
Image mode (📖 60)	L26: 📷 4608×3456 L25: 📷 3648×2736
White balance (📷24)	Auto
Continuous (📷27)	Single
Color options (📷28)	Standard color















## Movie Menu

Option	Default value
Movie options (📷38)	When a memory card is inserted: HD 720p (1280×720)
Autofocus mode (L26 only; 📷39)	Single AF

## Setup Menu















Option	Default value
Welcome screen (📷40)	None
Photo info (📷45)	Auto info
Brightness (📷45)	3
Print date (📷47)	Off
Electronic VR (📷48)	Off
Motion detection (📷50)	Auto



AF assist (L26 only;   51)	Auto
Button sound (   52)	On
Shutter sound (   52)	On
Auto off (   53)	30 s
Sleep mode (   53)	On
Blink warning (   56)	Off
Eye-Fi upload (   58)	Disable

## Others

Option	Default value
Paper size (   18,   19)	Default

- Selecting **Reset all** also clears the current file number (  63) from memory. Numbering will continue from the lowest number available. To reset file numbering to “0001”, delete all images saved in the internal memory or on the memory card ( 31) before selecting **Reset all**.
- The following menu settings will remain unaffected when menus are reset with **Reset all**.  
**Shooting menu:** Preset manual data (  25) acquired for **White balance**  
**Setup menu:** Settings for image registered for **Welcome screen** (  40), **Time zone and date** (  41), **Language** (  55), **Video mode** (  55), and **Battery type** (  62)

## Battery Type

MENU button →  tab → Battery type

To ensure that the camera shows the correct battery level ( 21), select the type that matches the batteries currently in use.

Option	Description
Alkaline (default setting)	LR6/L40 (AA-size) alkaline batteries
COOLPIX (Ni-MH)	Nikon EN-MH2 Ni-MH (nickel metal hydride) rechargeable batteries
Lithium	FR6/L91 (AA-size) lithium batteries

## Firmware Version

MENU button →  tab → Firmware version

View the current camera firmware version.

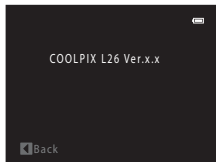

# File and Folder Names

Images and movies are assigned file names as follows.

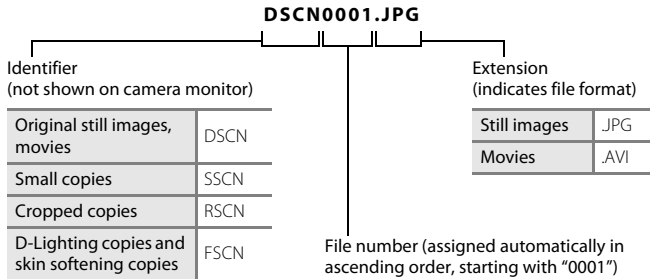

- Files are saved in folders named with a folder number followed by an identifier: "P\_" plus a three-digit sequential number for images captured in **Panorama assist** scene mode (e.g. "101P\_001"; 2) and "NIKON" for all other images (e.g. "100NIKON"). When the number of files within a folder reaches 9999, a new folder will be created. File numbers will be assigned automatically starting with "0001".
- Files copied using **Copy > Selected images** are copied to the current folder, where they are assigned new file numbers in ascending order starting from the largest file number in memory. **Copy > All images** copies all folders from the source medium; file names do not change but new folder numbers are assigned in ascending order, starting from the largest folder number on the destination medium (36).
- A single folder can hold up to 200 images; if the current folder already contains 200 images, a new folder, named by adding one to the current folder name, will be created the next time an image is captured. If the current folder is numbered 999 and contains 200 images, or an image is numbered 9999, no further images can be captured until the internal memory or memory card is formatted (54), or a new memory card is inserted.



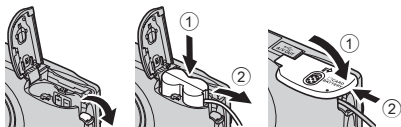
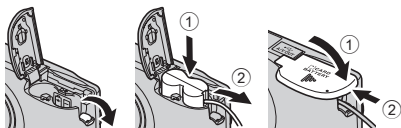

## Optional Accessories









Rechargeable battery	Rechargeable Ni-MH batteries EN-MH2-B2 (set of two EN-MH2 batteries) <sup>1</sup> Rechargeable Ni-MH batteries EN-MH2-B4 (set of four EN-MH2 batteries) <sup>1</sup>
Battery charger	Battery Charger MH-72 (includes two rechargeable Ni-MH batteries EN-MH2) <sup>1</sup> Battery Charger MH-73 (includes four rechargeable Ni-MH batteries EN-MH2) <sup>1</sup>
AC adapter	AC Adapter EH-65A (connect as shown)  COOLPIX L26   COOLPIX L25 
	AC Adapter EH-62B cannot be used.
USB cable	USB Cable UC-E16 <sup>2</sup>
Audio/video cable	Audio Video Cable EG-CP14







<sup>1</sup> To charge EN-MH2 batteries, use only Battery Charger MH-72 or MH-73. Do not use these battery chargers to charge any other type of battery.









<sup>2</sup> Included with the camera at the time of purchase (📖 ii).

## Error Messages

Display	Cause/Solution	
 (flashes)	Clock not set. Set date and time.	 41
Battery exhausted.	Replace the batteries.	10
 (flashes in red)	Camera cannot focus. <ul style="list-style-type: none"> <li>• Refocus.</li> <li>• Use focus lock.</li> </ul>	26, 28 64
Please wait for the camera to finish recording.	Wait until the image is saved and the message disappears from the display.	–
Memory card is write protected.	Write-protect switch is in “lock” position. Slide write-protect switch to “write” position.	–
Not available if Eye-Fi card is locked.	Eye-Fi card write-protect switch is in “lock” position. Slide write-protect switch to “write” position.	–
	Error accessing Eye-Fi card. <ul style="list-style-type: none"> <li>• Use approved card.</li> <li>• Check that terminals are clean.</li> <li>• Confirm that the card is correctly inserted.</li> </ul>	15 13 13
This card cannot be used.	Error accessing memory card. <ul style="list-style-type: none"> <li>• Use approved card.</li> <li>• Check that terminals are clean.</li> <li>• Confirm that the card is correctly inserted.</li> </ul>	15 13 13
This card cannot be read.		

Display	Cause/Solution	
Card is not formatted. Format card? Yes No	Memory card has not been formatted for use in this camera. Formatting deletes all data saved on the memory card. Be sure to select <b>No</b> and make copies of any images which need to be kept before formatting the memory card. Select <b>Yes</b> and press the  button to format the memory card.	 6
Out of memory.	Memory card is full. <ul style="list-style-type: none"> <li>• Select smaller image size.</li> <li>• Delete images.</li> <li>• Insert new memory card.</li> <li>• Remove memory card and use internal memory.</li> </ul>	60 31, 83 13 14
Image cannot be saved.	Error occurred while saving image. Format internal memory or memory card.	 54
	Camera has run out of file numbers. Insert a new memory card or format internal memory or memory card.	 63
	Image cannot be used for welcome screen. The following images cannot be registered as welcome screen. <ul style="list-style-type: none"> <li>• Images captured at an <b>Image mode</b> setting of </li> <li>• <b>4608x2592</b> for L26 and  <b>3584x2016</b> for L25</li> <li>• Images reduced to a size smaller than 320 x 240 by cropping or small picture editing</li> </ul>	 40
	Insufficient space to save a copy. Delete images from destination.	31
A blink was detected in the picture just taken.	One or more portrait subjects may have blinked when the picture was taken. Check the image in playback mode.	29,  23

Display	Cause/Solution	
Image cannot be modified.	Cannot edit selected image. <ul style="list-style-type: none"> <li>• Select images that support editing function.</li> <li>• Movies cannot be edited.</li> </ul>	 6 –
Cannot record movie.	Time out error while saving movie on the memory card. Select memory card with faster write speed.	13
Memory contains no images.	No images in the internal memory or memory card. <ul style="list-style-type: none"> <li>• Remove the memory card from the camera to play back images saved in the camera's internal memory.</li> <li>• To copy images from internal memory to memory card, press the <b>MENU</b> button. The copy screen will be displayed and images in the internal memory can be copied to memory card.</li> </ul>	13  36
File contains no image data.	File not created with this camera. File cannot be viewed on this camera. View file using a computer or the device used to create or edit this file.	–
All images are hidden.	No images available for a slide show.	 32
This image cannot be deleted.	Image is protected. Disable protection.	 33
Travel destination is in the current time zone.	Destination in same time zone as home.	 44
Lens error	Lens error. Turn camera off and then on again. If error persists, contact retailer or Nikon-authorized service representative.	20
Communications error	Error occurred during communication with printer. Turn camera off and reconnect USB cable.	 15

Display	Cause/Solution	
System error	Error has occurred in camera's internal circuitry. Turn camera off, remove and reinsert battery, and turn camera on. If error persists, contact retailer or Nikon-authorized service representative.	10, 21
Printer error: check printer status.	Printer error. Check printer. After solving the problem, select <b>Resume</b> and press the  button to resume printing.*	–
Printer error: check paper	Specified size of paper is not loaded in printer. Load the specified size of paper, select <b>Resume</b> , and press the  button to resume printing.*	–
Printer error: paper jam	Paper has jammed in printer. Remove the jammed paper, select <b>Resume</b> , and press the  button to resume printing.*	–
Printer error: out of paper	No paper is loaded in printer. Load the specified size of paper, select <b>Resume</b> , and press the  button to resume printing.*	–
Printer error: check ink	Ink error. Check ink, select <b>Resume</b> , and press the  button to resume printing.*	–
Printer error: out of ink	Running out of ink or ink cartridge is empty. Replace ink cartridge, select <b>Resume</b> , and press the  button to resume printing.*	–
Printer error: file corrupt	An error caused by the image file has occurred. Select <b>Cancel</b> and press the  button to cancel printing.	–

\* See the documentation provided with your printer for further guidance and information.





# Technical Notes and Index

<b>Caring for the Product</b> .....	2
The Camera.....	2
Batteries.....	4
Memory Cards.....	6
<b>Cleaning and Storage</b> .....	7
Cleaning.....	7
Storage.....	7
<b>Troubleshooting</b> .....	8
<b>Specifications</b> .....	15
Supported Standards.....	20
<b>Index</b> .....	21

# Caring for the Product

## The Camera

To ensure safe and continued enjoyment of your Nikon camera, observe the following precautions and the precautions noted in "For Your Safety" (📖 viii - xiv) when using or storing your camera.

### ✔ Do Not Subject the Product to Strong Shocks

The product may malfunction if dropped or struck. Additionally, do not touch or apply force to the lens or lens cover.

### ✔ Keep Dry

If water enters the camera, internal components may rust or otherwise become damaged, and repairing the camera may be expensive or even impossible.

### ✔ Avoid Sudden Changes in Temperature

Sudden changes in temperature, such as when entering or leaving a heated building on a cold day, can cause condensation to form inside the device. To prevent condensation, place the device in a carrying case or a plastic bag before exposing it to sudden changes in temperature.

### ✔ Keep away from Strong Magnetic Fields

Do not use or store this device in the vicinity of equipment that generates strong electromagnetic radiation or magnetic fields. Strong static charge or the magnetic fields produced by equipment such as radio transmitters could interfere with the monitor, damage data saved on the memory card, or affect the product's internal circuitry.

### ✔ Do Not Point the Lens at Strong Light Sources for Extended Periods

Avoid pointing the lens at the sun or other strong light sources for extended periods when using or storing the camera. Intense light may damage the image sensor or other components, producing a white blur effect in photographs.

## Turn the Camera off Before Removing the Batteries, AC adapter, or Memory card

Removing the batteries, AC adapter, or memory card while the camera is on could damage the camera or memory card. If removed while the camera is saving or deleting data, data may be lost and the camera's memory or the memory card may be damaged.

## Notes on the Monitor

- Monitors and electronic viewfinders are constructed with extremely high precision; at least 99.99% of pixels are effective, with no more than 0.01% being missing or defective. Hence while these displays may contain pixels that are always lit (white, red, blue, or green) or always off (black), this is not a malfunction and has no effect on images recorded with the device.
- Scraping or pressing on the surface of the monitor may result in damage or malfunction. Should the monitor break, care should be taken to avoid injury caused by broken glass and to prevent the liquid crystal from the display touching the skin or entering the eyes or mouth.
- Images in the monitor may be difficult to see under bright lighting.
- The monitor is lit by an LED backlight. Should the monitor begin to dim or flicker, contact your Nikon-authorized service representative.

## Notes About Smear

White or colored streaks may be visible when bright subjects are framed in the monitor. This phenomenon, known as “smear,” occurs when extremely bright light strikes the image sensor; it is characteristic of image sensors and does not indicate a malfunction. Smear may also take the form of partial discoloration in the monitor during shooting. It does not appear in images saved with the camera except in the cases of movies and of images saved with **Multi-shot 16** selected for **Continuous**. When shooting in these modes, we recommend that you avoid bright subjects such as the sun, reflected sunlight, and electric lights.

## Batteries

Be sure to read and follow the warnings noted in “For Your Safety” (📖 viii-xiv) before use.

### ✔ Notes About Using Batteries

- Used batteries may overheat. Handle with caution.
- Do not use batteries beyond their recommended expiration date.
- Do not turn the camera on and off repeatedly if discharged batteries are inserted in the camera.

### ✔ Spare Batteries

We recommend carrying spare batteries depending on where you are shooting. It may be difficult to purchase batteries in certain areas.

### ✔ Charging Batteries

If using optional rechargeable batteries, charge the batteries before taking pictures. Batteries are not charged at the time of purchase.

Be sure to read and follow the warnings noted in the operating instructions included with the battery charger.

### ✔ Charging Rechargeable Batteries

- Do not mix batteries with different amounts of charge remaining, or batteries of a different make or model.
- When using EN-MH2 batteries with the COOLPIX L26 and COOLPIX L25, charge the batteries two at a time using Battery Charger MH-72. When using Battery Charger MH-73, charge the batteries two or four at a time. Use only Battery Charger MH-72 or MH-73 to charge EN-MH2 batteries.
- When using Battery Charger MH-72 or MH-73, only charge EN-MH2 batteries.

### ✔ Notes About EN-MH1 Rechargeable Batteries and Battery Charger MH-70/71

- You can also use EN-MH1 Ni-MH rechargeable batteries with this camera.
- Use only Battery Charger MH-70 or MH-71 to charge EN-MH1 batteries.
- When using Battery Charger MH-70 or MH-71, only charge EN-MH1 batteries.
- Set the **Battery type** setting (📖 87, ⚙️ 62) to **COOLPIX (Ni-MH)**.

## Notes About Rechargeable Ni-MH Batteries

- If you repeatedly charge rechargeable Ni-MH batteries while they still have some charge remaining, the message **Battery exhausted.** may be displayed prematurely when using the batteries. This is due to the “memory effect,” in which the amount of charge the batteries can hold decreases temporarily. Use the batteries until there is no charge remaining and they will return to their normal behavior.
- Rechargeable Ni-MH batteries discharge even when not being used. We recommend charging the batteries just before using them.

## Cold Environment Usage

Battery performance decreases in cold environments. When using the camera in cold environments, try not to let the camera and batteries become too cold. The camera may not function if you use discharged batteries in cold environments. Keep spare batteries warm and alternate between two sets of batteries. Batteries that cannot be used because they have become too cold can often be used again when they have been warmed up.

## Battery Terminals

Dirt on the battery terminals can prevent the camera from functioning. Remove dirt from the terminals using a dry cloth.



## Remaining Battery Charge

If you insert discharged batteries into the camera, the camera may indicate that the batteries have adequate charge remaining. This is a characteristic of batteries.

## Recycling

Used batteries are a valuable resource. Please recycle used batteries in accordance with local regulations. Cover the battery terminals with tape when recycling.

## Memory Cards

- Use only Secure Digital memory cards. Approved memory cards →  15
- Observe the precautions noted in the documentation included with your memory card.
- Do not affix labels or stickers to the memory card.
- Do not format the memory card using a computer.
- Before using a memory card with this camera, format the card using this camera if the card has been used with another device. Before using a new memory card, we recommend using this camera to format the card.
- Note that **formatting a memory card permanently deletes all images and other data on the memory card**. If there is data saved on the memory card that you wish to keep, copy that data to a computer before formatting.
- If the message **Card is not formatted. Format card?** is displayed when you insert a memory card, the memory card must be formatted. If there is data on the memory card that you do not want to delete, select **No**. Copy that data to a computer before formatting. To format the memory card, select **Yes** and press the  button.
- Observe the following precautions while formatting the memory card, saving and deleting images, and copying images to a computer, otherwise data on the memory card itself may be damaged.
  - Do not open the battery-chamber/memory card slot cover or remove the memory card or batteries.
  - Do not turn off the camera
  - Do not disconnect the AC adapter

# Cleaning and Storage

## Cleaning

Do not use alcohol, thinner, or other volatile chemicals.

Lens	When cleaning the lens, avoid touching it directly with your fingers. Remove dust or lint with a blower. To remove fingerprints, oil, or other grime that cannot be removed with a blower, wipe the lens with a soft, dry cloth or an eyeglass cleaning cloth, using a gentle spiral motion that starts in the center and moves toward the edges. Do not wipe forcefully or wipe with a rough cloth, otherwise the camera may be damaged or malfunction. If you still cannot remove the grime, wet a soft cloth with a commercial liquid lens cleaner and gently wipe off the grime.
Monitor	Remove dust or lint with a blower. To remove fingerprints, oil, or other grime, wipe the area with a soft, dry cloth or an eyeglass cleaning cloth. Do not wipe forcefully or wipe with a rough cloth, otherwise the camera may be damaged or malfunction.
Body	<ul style="list-style-type: none"><li>Remove dust or lint with a blower. Wipe with a soft, dry cloth.</li><li>After using the camera at the beach or other sandy or dusty environment, wipe off any sand, dust, or salt with a dry cloth lightly dampened with fresh water and dry thoroughly.</li></ul> <p><b>Note that foreign matter inside the camera could cause damage not covered by the warranty.</b></p>

## Storage









Remove the batteries if the camera will not be used for an extended period. To prevent mold or malfunction and to ensure long, trouble-free use of the camera, we recommend you insert the batteries and operate the camera approximately once a month. Do not store the camera with naphtha or camphor moth balls, or in any of the following locations:

- Next to equipment that produces strong electromagnetic fields, such as televisions or radios
- Places that are exposed to temperatures below  $-10^{\circ}\text{C}$  ( $14^{\circ}\text{F}$ ) or above  $50^{\circ}\text{C}$  ( $122^{\circ}\text{F}$ )
- Places that are poorly ventilated or subject to humidity of over 60%





# Troubleshooting

If the camera fails to function as expected, check the list of common problems below before consulting your retailer or Nikon-authorized service representative.

## Power, Display, Settings Issues

Problem	Cause/Solution	
Camera turns off without warning.	<ul style="list-style-type: none"><li>• Battery is exhausted.</li><li>• Camera has turned off automatically to save power.</li><li>• The camera or battery have become too cold and cannot operate properly.</li></ul>	21 86,  53  4
Monitor is blank.	<ul style="list-style-type: none"><li>• Camera is off.</li><li>• Battery is exhausted.</li><li>• Standby mode for saving power: press the power switch, the shutter-release button,  button,  button, or  (movie-record) button.</li><li>• When flash lamp flashes, wait until flash has charged.</li><li>• Camera and computer are connected via USB cable.</li><li>• Camera and TV are connected via audio/video cable.</li></ul>	21 21 2, 22  50  69, 74  69,  12
Monitor is hard to read.	<ul style="list-style-type: none"><li>• Adjust monitor brightness.</li><li>• Monitor is dirty. Clean monitor.</li></ul>	86,  45  7



















Problem	Cause/Solution	
Date and time of recording are not correct.	<ul style="list-style-type: none"> <li>If camera clock has not been set, "Date not set" indicator flashes during shooting and movie recording. Images and movies saved before clock is set are dated "00/00/0000 00:00" or "01/01/2012 00:00" respectively. Set the correct time and date from the <b>Time zone and date</b> option in the setup menu.</li> <li>Check camera clock regularly against more accurate timepieces and reset as required.</li> </ul>	16, 86,  41
No indicators displayed in monitor.	<b>Hide info</b> is selected for <b>Photo info</b> . Select <b>Show info</b> .	86,  45
<b>Print date</b> not available.	<b>Time zone and date</b> has not been set.	16, 86,  41
Date not imprinted on images even when <b>Print date</b> is enabled.	<ul style="list-style-type: none"> <li>The current shooting mode is one that does not support <b>Print date</b>.</li> <li>The date cannot be imprinted on movies.</li> </ul>	86,  47
Screen for setting time zone and date is displayed when camera is turned on.	Clock battery is exhausted; all settings were restored to their default values.	16, 19
Camera settings reset.		
Camera becomes hot.	The camera may become hot when shooting movies or uploading images from an Eye-Fi card for an extended period of time, or when the camera is used in a hot area; this is not a malfunction.	-











## Characteristics of Digital Cameras



In extremely rare instances, unusual characters may appear in the monitor and the camera may stop functioning. In most cases, this phenomenon is caused by a strong external static charge. Turn the camera off, remove and replace the battery, then turn the camera on again. In the event of continued malfunction, contact your retailer or Nikon-authorized service representative. Note that disconnecting the power source as described above may result in the loss of any data not saved to internal memory or the memory card at the time the problem occurred. Data already saved will not be affected.

## Shooting Issues







Problem	Cause/Solution	
Cannot switch to shooting mode.	Disconnect audio/video cable or USB cable.	69, 74,  12,  15
No image captured when the shutter-release button is pressed.	<ul style="list-style-type: none"><li>• When camera is in playback mode, press the  button or the  button.</li><li>• When menus are displayed, press the <b>MENU</b> button.</li><li>• Battery is exhausted.</li><li>• When flash lamp flashes, flash is charging.</li></ul>	29 3, 5 21 50
Camera cannot focus.	<ul style="list-style-type: none"><li>• Subject is too close. Try shooting using easy auto mode, <b>Close-up</b> scene modes, or macro mode.</li><li>• The intended subject is one with which autofocus does not perform well.</li><li>• Set <b>AF assist</b> in the setup menu to <b>Auto</b> (L26 only).</li><li>• Turn camera off and then on again.</li></ul>	34, 39, 55 28 86,  51 21





Problem	Cause/Solution	
Images are blurred.	<ul style="list-style-type: none"> <li>• Use flash.</li> <li>• Enable electronic VR or motion detection.</li> <li>• Use <b>BSS</b> (best shot selector).</li> <li>• Use tripod and self-timer.</li> </ul>	50 86,  48,  50 40, 48,  27 53
Streaks of light or partial discoloration are visible in the monitor.	Smear occurs when extremely bright light strikes the image sensor. When shooting with <b>Continuous</b> set to <b>Multi-shot 16</b> and when recording movies, avoiding bright objects, such as the sun, reflections of the sun, and electric lights is recommended.	48,  27,  3
Bright specks appear in images captured with flash.	Flash is reflecting off particles in air. Set the flash mode setting to  (off).	51
Flash does not fire.	<ul style="list-style-type: none"> <li>• The flash mode is set to  (off).</li> <li>• Scene mode with which the flash does not fire is selected.</li> <li>• <b>On</b> is selected for <b>Blink proof</b> in smart portrait menu.</li> <li>• Another function that restricts flash is enabled.</li> </ul>	50 58 45,  23 62
Optical zoom cannot be used.	Optical zoom cannot be used while recording movies.	78
Digital zoom cannot be used.	<ul style="list-style-type: none"> <li>• Digital zoom cannot be used in the following situations.               <ul style="list-style-type: none"> <li>- When <b>Portrait</b>, <b>Night portrait</b>, or <b>Pet portrait</b> is selected in scene mode</li> <li>- When smart portrait mode is selected</li> <li>- When <b>Continuous</b> in the shooting menu is set to <b>Multi-shot 16</b></li> </ul> </li> </ul>	36, 37, 42 43 48,  27
<b>Image mode</b> not available.	Another function that restricts the <b>Image mode</b> option is enabled.	62

Problem	Cause/Solution	
No sound when shutter is released.	<ul style="list-style-type: none"> <li>• <b>Off</b> is selected for <b>Sound settings &gt; Shutter sound</b> in setup menu. No sound is heard with some shooting modes and settings, even when <b>On</b> is selected.</li> <li>• Do not block the speaker.</li> </ul>	86,  52  3, 5
AF-assist illuminator does not light (L26 only).	<b>Off</b> is selected for the <b>AF assist</b> option in the setup menu. AF-assist illuminator may not light depending on the current scene mode, even when <b>Auto</b> is selected.	86,  51
Images appear smeared.	Lens is dirty. Clean lens.	 7
Colors are unnatural.	White balance or hue is not adjusted properly.	39, 48,  24
Randomly spaced bright pixels (“noise”) appear in image.	The subject is dark, so shutter speed is too slow or ISO sensitivity is too high. Noise can be reduced by using flash.	50
Images are too dark (underexposed).	<ul style="list-style-type: none"> <li>• The flash mode is set to  (off).</li> <li>• Flash window is blocked.</li> <li>• Subject is beyond flash range.</li> <li>• Adjust exposure compensation.</li> <li>• Subject is backlit. Select <b>Backlighting</b> scene mode or set the flash mode setting to  (fill flash).</li> </ul>	50 23 50 57 40, 50
Images are too bright (overexposed).	Adjust exposure compensation.	57
Unexpected results when flash set to  (auto with red-eye reduction).	When taking pictures with  (auto with red-eye reduction) or fill flash with slow sync and red-eye reduction in <b>Night portrait</b> (either in easy auto mode or the Night portrait scene mode), red-eye reduction may be applied to areas not affected by red-eye in rare cases. Use auto mode or any scene mode other than <b>Night portrait</b> , and change the flash mode to any setting other than  (auto with red-eye reduction) and try taking a picture again.	37, 50

Problem	Cause/Solution	
Skin tones are not softened.	<ul style="list-style-type: none"> <li>In some shooting conditions, facial skin tones may not be smoothed.</li> <li>Use <b>Skin softening</b> in the playback menu for images containing four or more faces.</li> </ul>	44 68,  8
Saving images takes time.	<p>It may take more time to save images in the following situations.</p> <ul style="list-style-type: none"> <li>When the noise reduction function is in operation, such as when shooting in a dark environment</li> <li>When the flash mode is set to  (auto with red-eye reduction)</li> <li>When the skin softening function is applied while shooting</li> </ul>	– 52 36, 37, 45



## Playback Issues

Problem	Cause/Solution	
File cannot be played back.	<ul style="list-style-type: none"> <li>File or folder was overwritten or renamed by computer or other make of camera.</li> <li>The camera is not able to play back movies recorded with another make or model of digital camera.</li> </ul>	– 83
Cannot zoom in on image.	<ul style="list-style-type: none"> <li>Playback zoom cannot be used with movies, small pictures, or images that have been cropped to a size of 320 × 240 or smaller.</li> <li>This camera may not be able to zoom in on images captured with another make or model of digital camera.</li> </ul>	–
Cannot use D-Lighting, skin softening, small picture, or crop.	<ul style="list-style-type: none"> <li>These options cannot be used with movies.</li> <li>Images captured at an <b>Image mode</b> setting of  <b>4608×2592</b> for L26 and  <b>3584×2016</b> for L25 cannot be edited, and the same editing feature cannot be applied multiple times.</li> <li>Camera is unable to edit images captured with other cameras.</li> </ul>	– 68,  5,  6  68,  5,  6
Cannot rotate image.	The camera cannot rotate images captured with another make or model of digital camera.	–

Problem	Cause/Solution	
Images are not displayed on TV.	<ul style="list-style-type: none"> <li>• <b>Video mode</b> is not correctly set in the setup menu.</li> <li>• Memory card contains no images. Replace the memory card. Remove the memory card to play back images from the internal memory.</li> </ul>	87,  55 13
Nikon Transfer 2 does not start when camera is connected.	<ul style="list-style-type: none"> <li>• Camera is off.</li> <li>• Battery is exhausted.</li> <li>• USB cable is not correctly connected.</li> <li>• Camera is not recognized by the computer.</li> <li>• Confirm system requirements.</li> <li>• Computer is not set to start Nikon Transfer 2 automatically. For more information about Nikon Transfer 2, refer to help information contained in ViewNX 2.</li> </ul>	21 21 69, 74 – 71 74
Images to be printed are not displayed.	<ul style="list-style-type: none"> <li>• Memory card contains no images. Replace the memory card.</li> <li>• Remove the memory card to print images from the internal memory.</li> </ul>	13
Cannot select paper size with camera.	Paper size cannot be selected from the camera in the following situations, even when printing from a PictBridge-compatible printer. Use the printer to select paper size. <ul style="list-style-type: none"> <li>• The printer does not support the paper sizes specified by the camera.</li> <li>• The printer automatically selects the paper size.</li> </ul>	69,  18,  19 –

# Specifications

## Nikon COOLPIX L26 or COOLPIX L25 Digital Camera



Type	Compact digital camera
Effective pixels	COOLPIX L26: 16.1 million COOLPIX L25: 10.1 million
Image sensor	COOLPIX L26: $\frac{1}{2}$ 2.3-in. type CCD; approx. 16.44 million total pixels COOLPIX L25: $\frac{1}{3}$ -in. type CCD; approx. 10.44 million total pixels
Lens	5 $\times$ optical zoom, NIKKOR lens
Focal length	COOLPIX L26: 4.6-23.0mm (angle of view equivalent to that of 26-130 mm lens in 35mm [135] format) COOLPIX L25: 4.0-20.0mm (angle of view equivalent to that of 28-140 mm lens in 35mm [135] format)
f/-number	COOLPIX L26: f/3.2-6.5 COOLPIX L25: f/2.7-6.8
Construction	COOLPIX L26: 6 elements in 5 groups COOLPIX L25: 6 elements in 5 groups (1 ED lens element)
Digital zoom	COOLPIX L26: Up to 4 $\times$ (angle of view equivalent to that of approx. 520 mm lens in 35mm [135] format) COOLPIX L25: Up to 4 $\times$ (angle of view equivalent to that of approx. 560 mm lens in 35mm [135] format)
Vibration reduction	Electronic VR (still pictures)
Autofocus (AF)	Contrast-detect AF
Focus range (from lens)	COOLPIX L26: <ul style="list-style-type: none"><li>• [W]: Approx. 50 cm (1 ft 8 in.) to <math>\infty</math>, [T]: Approx. 80 cm (2 ft 8 in.) to <math>\infty</math></li><li>• Macro mode: Approx. 10 cm (4 in.) (wide-angle position relative to ) to <math>\infty</math></li></ul> COOLPIX L25: <ul style="list-style-type: none"><li>• [W]: Approx. 30 cm (1 ft) to <math>\infty</math>, [T]: Approx. 60 cm (2 ft) to <math>\infty</math></li><li>• Macro mode: Approx. 3 cm (1.2 in.) (zoom position at ) to <math>\infty</math></li></ul>
Focus-area selection	Center, face detection

<b>Monitor</b>	7.5-cm (3-in.), approx. 230k-dot, TFT LCD with 5-level brightness adjustment
<b>Frame coverage (shooting mode)</b>	Approx. 98% horizontal and 98% vertical
<b>Frame coverage (playback mode)</b>	Approx. 100% horizontal and 100% vertical
<b>Storage</b>	
<b>Media</b>	Internal memory (approx. 20 MB), SD/SDHC/SDXC memory card
<b>File system</b>	DCF, Exif 2.3, and DPOF compliant
<b>File formats</b>	Still pictures: JPEG Movies: AVI (Motion-JPEG compliant)
<b>Image size (pixels)</b>	COOLPIX L26: <ul style="list-style-type: none"> <li>• 16M (High) [4608 × 3456★]</li> <li>• 16M [4608 × 3456]</li> <li>• 8M [3264 × 2448]</li> <li>• 4M [2272 × 1704]</li> <li>• 2M [1600 × 1200]</li> <li>• VGA [640 × 480]</li> <li>• 16:9 [4608 × 2592]</li> </ul> COOLPIX L25: <ul style="list-style-type: none"> <li>• 10M (High) [3648 × 2736★]</li> <li>• 10M [3648 × 2736]</li> <li>• 8M [3264 × 2448]</li> <li>• 4M [2272 × 1704]</li> <li>• 2M [1600 × 1200]</li> <li>• VGA [640 × 480]</li> <li>• 16:9 [3584 × 2016]</li> </ul>
<b>ISO sensitivity (Standard output sensitivity)</b>	Auto (auto gain from ISO 80 to 1600)



<b>Exposure</b>	
<b>Metering</b>	256-segment matrix, center-weighted (digital zoom less than 2x), spot (digital zoom 2x or more)
<b>Exposure control</b>	Programmed auto exposure with motion detection and exposure compensation (–2.0 to +2.0 EV in steps of $\frac{1}{3}$ EV)
<b>Shutter</b>	Mechanical and charge-coupled electronic shutter
<b>Speed</b>	<ul style="list-style-type: none"> <li>• <math>\frac{1}{2000}</math>–1 s</li> <li>• 4 s (<b>Fireworks show</b> scene mode)</li> </ul>
<b>Aperture</b>	COOLPIX L26: Electronically-controlled ND filter (–2.7 AV) selection COOLPIX L25: Electronically-controlled ND filter (–2 AV) selection
<b>Range</b>	COOLPIX L26: 2 steps (f/3.2 and f/8 [W]) COOLPIX L25: 2 steps (f/2.7 and f/5.4 [W])
<b>Self-timer</b>	Approx. 10 s
<b>Built-in flash</b>	
<b>Range (approx.) (ISO sensitivity: Auto)</b>	COOLPIX L26: [W]: 0.5 to 3.6 m (1 ft 8 in. to 11 ft) [T]: 0.8 to 1.7 m (2 ft 8 in. to 5 ft 6 in.) COOLPIX L25: [W]: 0.3 to 4.2 m (1 ft to 13 ft) [T]: 0.6 to 1.6 m (2 ft to 5 ft 2 in.)
<b>Flash control</b>	TTL auto flash with monitor preflashes
<b>Interface</b>	Hi-Speed USB
<b>Data transfer protocol</b>	MTP, PTP
<b>Video output</b>	Can be selected from <b>NTSC</b> and <b>PAL</b>
<b>I/O terminal</b>	Audio/video (A/V) output; digital I/O (USB)
<b>Supported languages</b>	Arabic, Chinese (Simplified and Traditional), Czech, Danish, Dutch, English, Finnish, French, German, Greek, Hindi, Hungarian, Indonesian, Italian, Japanese, Korean, Norwegian, Polish, Portuguese (European and Brazilian), Romanian, Russian, Spanish, Swedish, Thai, Turkish, Ukrainian, Vietnamese

<b>Power sources</b>	<ul style="list-style-type: none"> <li>• Two LR6/L40 (AA-size) alkaline batteries</li> <li>• Two FR6/L91 (AA-size) lithium batteries</li> <li>• Two EN-MH2 rechargeable Ni-MH batteries (available separately)</li> <li>• AC Adapter EH-65A (available separately)</li> </ul>
<b>Battery life</b>	<p>COOLPIX L26:</p> <p>Still pictures*:</p> <ul style="list-style-type: none"> <li>• Approx. 200 shots when using alkaline batteries</li> <li>• Approx. 680 shots when using lithium batteries</li> <li>• Approx. 350 shots when using EN-MH2 batteries</li> </ul> <p>Movies:</p> <ul style="list-style-type: none"> <li>• Approx. 50 min when using alkaline batteries (HD 720p)</li> <li>• Approx. 3 h 20 min when using lithium batteries (HD 720p)</li> <li>• Approx. 1 h 55 min when using EN-MH2 batteries (HD 720p)</li> </ul> <p>COOLPIX L25:</p> <p>Still pictures*:</p> <ul style="list-style-type: none"> <li>• Approx. 220 shots when using alkaline batteries</li> <li>• Approx. 680 shots when using lithium batteries</li> <li>• Approx. 370 shots when using EN-MH2 batteries</li> </ul> <p>Movies:</p> <ul style="list-style-type: none"> <li>• Approx. 55 min when using alkaline batteries (HD 720p)</li> <li>• Approx. 3 h 45 min when using lithium batteries (HD 720p)</li> <li>• Approx. 2 h 10 min when using EN-MH2 batteries (HD 720p)</li> </ul>
<b>Tripod socket</b>	1/4 (ISO 1222)
<b>Dimensions (W × H × D)</b>	COOLPIX L26: Approx. 96.0 × 59.7 × 28.8 mm (3.8 × 2.4 × 1.2 in.) (excluding projections) COOLPIX L25: Approx. 96.2 × 60.4 × 29.2 mm (3.8 × 2.4 × 1.2 in.) (excluding projections)
<b>Weight</b>	COOLPIX L26: Approx. 164 g (5.8 oz) (including battery and SD memory card) COOLPIX L25: Approx. 171 g (6.1 oz) (including battery and SD memory card)
<b>Operating environment</b>	
Temperature	0°C to 40°C (32°F to 104°F)
Humidity	Less than 85% (no condensation)

- Unless otherwise stated, all figures are for a camera with a fully-charged LR6/L40 (AA-size) alkaline batteries operated at an ambient temperature of 25°C (77°F).
- \* Based on Camera and Imaging Products Association (CIPA) standards for measuring the life of camera batteries. Measured at 23 (±2)°C (73 (±4)°F); zoom adjusted with each shot, flash fired with every other shot, image mode set to  **4608×3456** for the L26,  **3648×2736** for the L25. Battery life may vary depending on shooting interval and length of time menus and images are displayed. Data for lithium batteries apply when using two commercially available FR6/L91 (AA-size) Energizer(R) Ultimate Lithium batteries. The included batteries are for trial use only.

## Specifications

- Nikon will not be held liable for any errors this manual may contain.
- The appearance of this product and its specifications are subject to change without notice.

## Supported Standards

- **DCF:** Design Rule for Camera File System is a standard widely used in the digital camera industry to ensure compatibility among different makes of camera.
- **DPOF:** Digital Print Order Format is an industry-wide standard that allows images to be printed from print orders saved on memory cards.
- **Exif version 2.3:** Exchangeable image file format (Exif) version 2.3 for digital still cameras is a standard that allows information saved with photographs to be used for optimal color reproduction when images are output from Exif-compliant printers.
- **PictBridge:** A standard developed cooperatively by the digital camera and printer industries, allowing photographs to be output directly to a printer without connecting the camera to a computer.

# Index

## Symbols

<b>AE/AF-L</b> .....	4
<b>T</b> (Tele).....	24
<b>W</b> (Wide).....	24
Playback zoom.....	66
Image thumbnail display .....	67
Easy auto mode.....	34
Scene mode.....	35
Smart portrait mode.....	43
Auto mode.....	47
Playback mode.....	29
Setup menu .....	86
Apply selection button.....	3, 5
Shooting mode button.....	3, 5
Movie-record button.....	3, 5
Playback button .....	3, 5, 29
Delete button.....	3, 5, 31
<b>MENU</b> button .....	3, 5, 45, 48, 68, 81, 86
Flash mode .....	50
Self-timer.....	53
Macro mode .....	55
Exposure compensation .....	57
Help.....	35

## A

AC adapter .....	12,  64
AF-assist illuminator .....	2, 86,  51
Alkaline batteries.....	10
Aperture value .....	27
Audio/video cable.....	70,  12,  64
Audio/video-in jack .....	70,  12
Auto flash.....	51
Auto mode.....	47
Auto off.....	22, 86,  53
Autofocus.....	28, 56
Autofocus mode.....	81,  39
AVI.....	63

## B

Backlighting  .....	40
Battery.....	10, 19
Battery chamber .....	3, 5
Battery charger .....	64
Battery level .....	21
Battery type.....	87,  62
Battery-chamber/memory card slot cover .....	3, 5, 13
Beach  .....	38
Best shot selector.....	40,  27
Black and white copy  .....	40
Black-and-white .....	48,  28

Blink proof.....	45,	23
Blink warning.....	87,	56
Brightness.....		45
BSS.....	40,	27
Button sound.....		52

## C

Calendar display.....		67
Charger.....		64
Close-up		39
Color options.....	48,	28
Compression ratio.....		60
Computer.....	70, 74	
Connector cover.....		3, 5
Continuous.....	48,	27
Copying images.....	68,	36
Crop.....	66,	10
Cyanotype.....	48,	28

## D

Date.....	16, 86,	41
Date and time.....	16, 86,	41
Date format.....	17,	41
Daylight saving time.....	17,	43
Delete.....		31
Digital zoom.....		24
Direct print.....	70,	14
D-Lighting.....	68,	7
DPOF.....		20
DPOF print.....		21
DSCN.....		63
Dusk/dawn		38

## E

Easy auto mode.....		34
Electronic VR.....	86,	48
EN-MH1.....		4
EN-MH2.....		64
Exposure compensation.....		57
Extension.....		63
Eye-Fi upload.....	87,	58
Eyelet for camera strap.....		2, 4

## F

Face detection.....		63
File name.....		63
Fill flash.....		51
Fireworks show		40
Firmware version.....	87,	62
Flash.....		2, 4, 50
Flash lamp.....		3, 5, 50
Flash mode.....		50, 51
Flash off.....		51
Focus.....		26, 63
Focus indicator.....		7
Focus lock.....		64
Folder name.....		63
Food		39
Format internal memory.....	87,	54
Format memory cards.....	14, 87,	54
Formatting.....	14, 87,	54
FSCN.....		63
Full-frame playback.....		29
Full-time AF.....	81,	39

<b>H</b>	
Help.....	35
<b>I</b>	
Identifier.....	63
Image mode.....	60
Internal memory.....	14
<b>J</b>	
JPG.....	63
<b>L</b>	
Landscape .....	36
Language.....	87,  55
Lens.....	2, 4,  15
Lens cover.....	2, 4
Lithium batteries.....	10
<b>M</b>	
Macro mode.....	55
Memory capacity.....	21
Memory card.....	13
Memory card slot.....	3, 5, 13
Microphone.....	2, 4
Monitor.....	3, 5, 6,  7
Monitor settings.....	86,  45
Motion detection.....	86,  50
Movie length.....	80
Movie menu.....	81
Movie options.....	81,  38
Movie playback.....	82
Movie recording.....	78
Movie-record button.....	3, 5
Multi selector.....	3, 5
Multi-shot 16.....	27
Museum .....	40
<b>N</b>	
Nickel-metal hydride rechargeable batteries.....	10
Night landscape .....	39
Night portrait .....	37
Nikon Transfer 2.....	71, 73, 75
Number of exposures remaining....	21, 61
<b>O</b>	
Optical zoom.....	24
Optional accessories.....	64
<b>P</b>	
Panorama assist .....	41,  2
Panorama Maker 6.....	41, 73,  4
Paper size.....	18,  19
Party/indoor .....	37
Pet portrait auto release.....	42
Pet portrait .....	42
Photo info.....	45
PictBridge.....	70,  14,  20
Playback.....	29, 82
Playback button.....	3, 5
Playback menu.....	68,  29
Playback mode.....	29
Playback zoom.....	66
Portrait .....	36
Power.....	20, 21
Power switch.....	20, 21
Power switch/power-on lamp.....	2, 4

Power-on lamp ..... 20, 21  
Preset manual ..... 25  
Pressing halfway ..... 27  
Print ..... 68, 70, 17, 19, 29  
Print date ..... 19, 86, 47  
Print order ..... 68, 29  
Print order date option... 19, 30, 31  
Printer ..... 70, 14  
Protect ..... 68, 33

## **R**

Rechargeable battery ..... 64  
Recording movies ..... 78  
Red-eye reduction ..... 51, 52  
Reset all ..... 87, 59  
Rotate image ..... 68, 35  
RSCN ..... 63

## **S**

Scene mode ..... 35, 36  
Self-timer ..... 53  
Self-timer lamp ..... 2, 4, 54  
Sepia ..... 48, 28  
Setup menu ..... 86  
Shooting ..... 20, 23, 26  
Shooting menu ..... 48, 24  
Shooting mode button ..... 3, 5  
Shutter sound ..... 52  
Shutter speed ..... 27  
Shutter-release button ..... 2, 4, 26  
Single ..... 48, 27  
Single AF ..... 81, 39

Skin softening ..... 45, 68, 8, 22  
Sleep mode ..... 53  
Slide show ..... 68, 32  
Slow sync ..... 51  
Small picture ..... 68, 9  
Smart portrait menu ..... 45, 22  
Smart portrait mode ..... 43  
Smile timer ..... 45, 23  
Snow ..... 38  
Sound settings ..... 86, 52  
Speaker ..... 3, 5  
Sports ..... 37  
SSCN ..... 63  
Standard color ..... 48, 28  
Strap ..... iii  
Sunset ..... 38

## **T**

Thumbnail display ..... 67  
Time difference ..... 44  
Time zone ..... 17, 41, 44  
Tripod socket ..... 3, 5, 18  
TV ..... 70, 12

## **U**

USB cable ..... 69, 74, 16, 64  
USB/audio/video output connector  
..... 3, 5, 69, 74, 12, 14

## **V**

Video mode ..... 87, 55  
ViewNX 2 ..... 71, 73  
Vivid color ..... 48, 28



Volume ..... 83

## **W**

Welcome screen ..... 86,  40

White balance ..... 48,  24

## **Z**

Zoom ..... 24

Zoom control ..... 2, 4, 24

Zoom in ..... 24

Zoom out ..... 24



A series of ten horizontal dashed lines spanning the width of the page, intended for handwriting practice.



# ***Nikon***

No reproduction in any form of this manual, in whole or in part (except for brief quotation in critical articles or reviews), may be made without written authorization from NIKON CORPORATION.

**NIKON CORPORATION**

© 2012 Nikon Corporation



CT1L01(11)  
6MM26611-01