

Nikon

DIGITAL CAMERA

COOLPIX P7700

Reference Manual

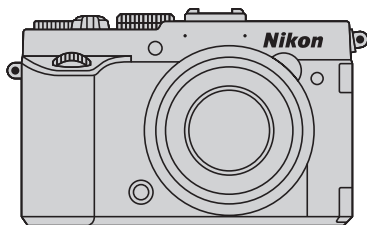

En

COOLPIX P7700 Recommended Features



P, S, A, M Mode 48

Choose these modes for greater control over shutter speed and aperture value. Settings in the quick menu (67) or shooting menu (71) are available to suit the shooting conditions and the type of shot you want to capture.

U1, U2, U3 User Settings Mode 52

Up to 3 setting combinations that are frequently used for shooting can be saved in U1, U2 and U3.

Movie Mode and CSM (Movie Custom Setting) Mode..... 101

In movie mode, you can record slow motion and fast motion movies, in addition to basic movies.

In movie custom setting mode, you can use aperture-priority auto or manual mode, or change the settings for image recording.

Compatibility with a Variety of Accessories (Available Separately)

• Speedlights (External Flash Unit)..... 87

You can use the Speedlight that supports the Nikon Creative Lighting System (CLS). Also, an off-camera flash can be controlled wirelessly by setting the flash mode to **COMMAND** (commander mode).

• Remote Control 55

The shutter can be released remotely using the Remote Control ML-L3 or Remote Cord MC-DC2.

• GPS Unit 114

You can record position information (latitude and longitude) on the pictures to be shot.

Introduction

Parts of the Camera and Main Functions

The Basics of Shooting and Playback

Shooting Features

Playback Features

Recording and Playing Back Movies

General Camera Setup

Reference Section

Technical Notes and Index

Introduction

Read This First

Thank you for purchasing the Nikon COOLPIX P7700 digital camera.

Before using the camera, please read the information in “For Your Safety” (vi to viii) and familiarize yourself with the information provided in this manual. After reading, please keep this manual handy and refer to it to enhance your enjoyment of your new camera.

Confirming the Package Contents

In the event that any items are missing, please contact the store where you purchased the camera.



COOLPIX P7700
Digital Camera
(with Accessory Shoe Cover
BS-1)



Camera Strap



Lens Cap LC-CP26
(attached to the camera
body)

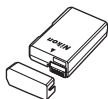

Rechargeable Li-ion
Battery EN-EL14
(with terminal cover)

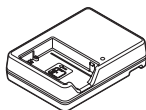

Battery Charger
MH-24*

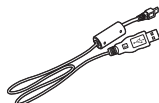

USB Cable UC-E17

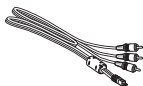

Audio Video Cable EG-CP16



ViewNX 2 (CD-ROM)



Reference Manual
(CD-ROM)

- Warranty

* A plug adapter is included if the camera was purchased in a country or region that requires a plug adapter. The shape of the plug adapter varies with the country or region of purchase.

NOTE: A memory card is not included with the camera.

About This Manual





If you want to start using the camera right away, see “The Basics of Shooting and Playback” (📖16).

See “Parts of the Camera and Main Functions” (📖1) for more information on the names and principle functions of the camera parts.

Other Information

- Symbols and Conventions

To make it easier to find the information you need, the following symbols and conventions are used in this manual:

Icon	Description
	This icon indicates cautions and information that should be read before using the camera.
	This icon marks notes, information that should be read before using the camera.
	These icons indicate other pages containing relevant information;  : “Reference Section”,  : “Technical Notes and Index.”

- SD, SDHC and SDXC memory cards are referred to as “memory cards” in this manual.
- The setting at the time of purchase is referred to as the “default setting.”
- The names of menu items displayed in the monitor screen, and the names of buttons or messages displayed on a computer monitor appear in bold.
- In this manual, images are sometimes omitted from monitor screen samples so that monitor indicators can be more clearly shown.
- The illustrations of monitor content and camera may differ from the actual product.

Information and Precautions

Life-Long Learning

As part of Nikon's "Life-Long Learning" commitment to ongoing product support and education, continually updated information is available online at the following sites:

- For users in the U.S.A.: <http://www.nikonusa.com/>
- For users in Europe and Africa: <http://www.europe-nikon.com/support/>
- For users in Asia, Oceania, and the Middle East: <http://www.nikon-asia.com/>

Visit these sites to keep up-to-date with the latest product information, tips, answers to frequently asked questions (FAQs), and general advice on digital imaging and photography. Additional information may be available from the Nikon representative in your area. Visit the site below for contact information:

<http://imaging.nikon.com/>

Use Only Nikon Brand Electronic Accessories

Nikon COOLPIX cameras are designed to the highest standards and include complex electronic circuitry. Only Nikon brand electronic accessories (including battery chargers, batteries and AC adapters) certified by Nikon specifically for use with this Nikon digital camera are engineered and proven to operate within the operational and safety requirements of this electronic circuitry.

THE USE OF NON-NIKON ELECTRONIC ACCESSORIES COULD DAMAGE THE CAMERA AND MAY VOID YOUR NIKON WARRANTY.

The use of third-party rechargeable Li-ion batteries not bearing the Nikon holographic seal could interfere with normal operation of the camera or result in the batteries overheating, igniting, rupturing, or leaking.

For more information about Nikon brand accessories, contact a local authorized Nikon dealer.

Holographic seal: Identifies this device as an authentic Nikon product.



Before Taking Important Pictures

Before taking pictures on important occasions (such as at weddings or before taking the camera on a trip), take a test shot to ensure that the camera is functioning normally. Nikon will not be held liable for damages or lost profits that may result from product malfunction.

About the Manuals

- No part of the manuals included with this product may be reproduced, transmitted, transcribed, stored in a retrieval system, or translated into any language in any form, by any means, without Nikon's prior written permission.
- Nikon will not be held liable for any damages resulting from the use of this product.
- Nikon reserves the right to change the specifications of the hardware and software described in the documentation at any time and without prior notice.
- While every effort was made to ensure that the information in the documentation is accurate and complete, we would appreciate it were you to bring any errors or omissions to the attention of the Nikon representative in your area (address provided separately).

Notice Concerning Prohibition of Copying or Reproduction

Note that simply being in possession of material that was digitally copied or reproduced by means of a scanner, digital camera or other device may be punishable by law.

• Items prohibited by law from being copied or reproduced

Do not copy or reproduce paper money, coins, securities, government bonds or local government bonds, even if such copies or reproductions are stamped "Sample." The copying or reproduction of paper money, coins, or securities which are circulated in a foreign country is prohibited. Unless the prior permission of the government was obtained, the copying or reproduction of unused postage stamps or post cards issued by the government is prohibited.

The copying or reproduction of stamps issued by the government and of certified documents stipulated by law is prohibited.

• Cautions on certain copies and reproductions

The government has issued cautions on copies or reproductions of securities issued by private companies (shares, bills, checks, gift certificates, etc.), commuter passes, or coupon tickets, except when a minimum of necessary copies are to be provided for business use by a company. Also, do not copy or reproduce passports issued by the government, licenses issued by public agencies and private groups, ID cards and tickets, such as passes and meal coupons.

• Comply with copyright notices

The copying or reproduction of copyrighted creative works such as books, music, paintings, woodcut prints, maps, drawings, movies, and photographs is governed by national and international copyright laws. Do not use this product for the purpose of making illegal copies or to infringe copyright laws.

Disposing of Data Storage Devices

Please note that deleting images or formatting data storage devices such as memory cards or built-in camera memory does not completely erase the original image data. Deleted files can sometimes be recovered from discarded storage devices using commercially available software, potentially resulting in the malicious use of personal image data. Ensuring the privacy of such data is the user's responsibility.

Before discarding a data storage device or transferring ownership to another person, erase all data using commercial deletion software, or format the device and then completely refill it with images containing no private information (for example, pictures of empty sky) (remove the GPS Unit (available separately)). Be sure to also replace any pictures selected for the **Select an image** option in the **Welcome screen** setting (📷110). Care should be taken to avoid injury or damage to property when physically destroying data storage devices.

For Your Safety

To prevent damage to your Nikon product or injury to yourself or to others, read the following safety precautions in their entirety before using this equipment. Keep these safety instructions where all those who use the product will read them.



This icon marks warnings, information that should be read before using this Nikon product, to prevent possible injury.

WARNINGS

Turn off in the event of malfunction

Should you notice smoke or an unusual smell coming from the camera or Battery Charger, unplug the Battery Charger and remove the battery immediately, taking care to avoid burns. Continued operation could result in injury. After removing or disconnecting the power source, take the equipment to a Nikon-authorized service representative for inspection.

Do not disassemble

Touching the internal parts of the camera or Battery Charger could result in injury. Repairs should be performed only by qualified technicians. Should the camera or Battery Charger break open as the result of a fall or other accident, take the product to a Nikon-authorized service representative for inspection, after unplugging the product and/or removing the battery.

Do not use the camera or Battery Charger in the presence of flammable gas

Using the camera in the presence of flammable gases such as propane and gasoline, as well as flammable sprays or dust could result in explosion or fire.

Handle the camera strap with care

Never place the strap around the neck of an infant or child.

Keep out of reach of children

Do not keep the products within reach of children. Doing so may cause injury. Particular care should be taken to prevent infants from putting the battery or other small parts into their mouths.

Do not remain in contact with the camera, battery charger, or AC adapter for extended periods while the devices are on or in use.

Parts of the devices become hot. Leaving the devices in direct contact with the skin for extended periods may result in low-temperature burns.

Observe caution when handling the battery

The battery may leak, overheat, or explode if improperly handled. Observe the following precautions when handling the battery for use in this product:

- Before replacing the battery, turn the product off. If you are using the Battery Charger/AC adapter, be sure it is unplugged.
- Use only a Rechargeable Li-ion Battery EN-EL14 (included). Charge the battery by inserting it in a Battery Charger MH-24 (included). For Remote Control ML-L3 (available separately), use only 3 V CR2025 lithium battery.
- When inserting the battery, do not attempt to insert it upside down or backwards.
- Do not disassemble the battery or attempt to remove or break the battery insulation or casing.
- Do not expose the battery to flame or to excessive heat.
- Do not immerse in or expose to water.
- Replace the terminal cover when transporting the battery. Do not transport or store with metal objects such as necklaces or hairpins.
- The battery is prone to leakage when fully discharged. To avoid damage to the product, be sure to remove the battery when no charge remains.
- Discontinue use immediately should you notice any change in the battery, such as discoloration or deformation.

- If liquid from the damaged battery comes in contact with clothing or skin, rinse immediately with plenty of water.
- If leaked battery fluid gets into your eyes, rinse them out immediately with clean running water and get medical treatment.
- Do not attempt to charge batteries that are not rechargeable.

Observe the following precautions when handling the Battery Charger

- Keep dry. Failure to observe this precaution could result in fire or electric shock.
- Dust on or near the metal parts of the plug should be removed with a dry cloth. Continued use could result in fire.
- Do not handle the plug or go near the Battery Charger during lightning storms. Failure to observe this precaution could result in electric shock.
- Do not damage, modify, forcibly tug or bend the USB cable, place it under heavy objects, or expose it to heat or flames. Should the insulation be damaged and the wires become exposed, take it to a Nikon-authorized service representative for inspection. Failure to observe these precautions could result in fire or electric shock.

- Do not handle the plug or Battery Charger with wet hands. Failure to observe this precaution could result in electric shock.
- Do not use with travel converters or adapters designed to convert from one voltage to another or with DC-to-AC inverters. Failure to observe this precaution could damage the product or cause overheating or fire.

Use appropriate cables

When connecting cables to the input and output jacks, use only the cables provided or sold by Nikon for the purpose, to maintain compliance with product regulations.

Handle moving parts with care

Be careful that your fingers or other objects are not pinched by the lens cover or other moving parts.

CD-ROMs

The CD-ROMs included with this device should not be played back on audio CD equipment. Playing CD-ROMs on an audio CD player could cause hearing loss or damage the equipment.

Observe caution when using the flash

Using the flash close to your subject's eyes could cause temporary visual impairment. Particular care should be observed if photographing infants, when the flash should be no less than 1 m (3 ft 4 in.) from the subject.

Do not operate the flash with the flash window touching a person or object

Failure to observe this precaution could result in burns or fire.

Avoid contact with liquid crystal

Should the monitor break, care should be taken to avoid injury caused by broken glass and to prevent liquid crystal from the monitor touching the skin or entering the eyes or mouth.

Turn the power off when using inside an airplane or the hospital

Turn the power off while inside the airplane during take off or landing. Also, before boarding an airplane, set the GPS tracking information recording function to OFF. Follow the instructions of the hospital when using while in a hospital. The electromagnetic waves emitted by this camera may disrupt the electronic systems of the airplane or the instruments of the hospital.

3D Images

Do not continuously view 3D images recorded with this device for extended periods, whether on a television, monitor, or other display. In the case of children whose visual systems are still maturing, consult a pediatrician or ophthalmologist prior to use and follow their instructions. Prolonged viewing of 3D images may cause eye strain, nausea, or discomfort. Cease use should any of these symptoms occur and consult a physician if necessary.

Notices

Notices for Customers in the U.S.A.

IMPORTANT SAFETY INSTRUCTIONS -

SAVE THESE INSTRUCTIONS.

DANGER - TO REDUCE THE RISK OF FIRE OR ELECTRIC SHOCK, CAREFULLY FOLLOW THESE INSTRUCTIONS

For connection to a supply not in the U.S.A., use an attachment plug adapter of the proper configuration for the power outlet if needed.

The power supply unit is intended to be correctly orientated in a vertical or floor mount position.

Federal Communications Commission (FCC) Radio Frequency Interference Statement

This equipment has been tested and found to comply with the limits for a Class B digital device, pursuant to Part 15 of the FCC rules. These limits are designed to provide reasonable protection against harmful interference in a residential installation. This equipment generates, uses, and can radiate radio frequency energy and, if not installed and used in accordance with the instructions, may cause harmful interference to radio communications. However, there is no guarantee that interference will not occur in a particular installation. If this

equipment does cause harmful interference to radio or television reception, which can be determined by turning the equipment off and on, the user is encouraged to try to correct the interference by one or more of the following measures:

- Reorient or relocate the receiving antenna.
- Increase the separation between the equipment and receiver.
- Connect the equipment into an outlet on a circuit different from that to which the receiver is connected.
- Consult the dealer or an experienced radio/television technician for help.



Nikon

COOLPIX P7700

CAUTIONS

Modifications

The FCC requires the user to be notified that any changes or modifications made to this device that are not expressly approved by Nikon Corporation may void the user's authority to operate the equipment.

Interface Cables

Use the interface cables sold or provided by Nikon for your equipment. Using other interface cables may exceed the limits of Class B Part 15 of the FCC rules.

Notice for Customers in the State of California

WARNING

Handling the cord on this product will expose you to lead, a chemical known to the State of California to cause birth defects or other reproductive harm.

Wash hands after handling.

Nikon Inc.,
1300 Walt Whitman Road,
Melville, New York 11747-3064
USA
Tel: 631-547-4200

Notice for Customers in Canada

CAUTION

This Class B digital apparatus complies with Canadian ICES-003.

ATTENTION

Cet appareil numérique de la classe B est conforme à la norme NMB-003 du Canada.

Notices for Customers in Europe

CAUTIONS

RISK OF EXPLOSION IF BATTERY IS REPLACED BY AN INCORRECT TYPE.

DISPOSE OF USED BATTERIES ACCORDING TO THE INSTRUCTIONS.

This symbol indicates that this product is to be collected separately.



The following apply only to users in European countries:

- This product is designated for separate collection at an appropriate collection point. Do not dispose of as household waste.
- For more information, contact the retailer or the local authorities in charge of waste management.

This symbol on the battery indicates that the battery is to be collected separately.





































The following apply only to users in European countries:



















































- All batteries, whether marked with this symbol or not, are designated for separate collection at an appropriate collection point. Do not dispose of as household waste.
- For more information, contact the retailer or the local authorities in charge of waste management.

Table of Contents













Introduction	ii
Read This First.....	ii
Confirming the Package Contents.....	ii
About This Manual.....	iii
Information and Precautions.....	iv
For Your Safety	vi
WARNINGS	vi
Notices	ix
Parts of the Camera and Main Functions.....	1
The Camera Body.....	1
Principle Functions of the Controls.....	3
Attaching the Camera Strap	7
Attaching and Detaching the Lens Cap.....	7
Opening and Adjusting the Angle of the Monitor	8
Switching the Monitor Screen (DISP Button).....	9
Basic Menu Operations	10
Monitor Screen	12
The Basics of Shooting and Playback.....	16
Preparation 1 Charge the Battery.....	16
Preparation 2 Insert the Battery.....	18
Preparation 3 Insert a Memory Card	20
Internal Memory and Memory Cards.....	21
Approved Memory Cards.....	21
Step 1 Turn the Camera On	22
Turning the Camera On and Off.....	23
Setting the Display Language, Date, and Time.....	24
Step 2 Select a Shooting Mode.....	26
Available Shooting Modes	27
Step 3 Frame a Picture.....	28
Using the Zoom.....	29
Step 4 Focus and Shoot	30
Step 5 Play Back Images	32
Step 6 Delete Unwanted Images.....	33
Shooting Features.....	34
📷 (Auto) Mode.....	34
Scene Mode (Shooting Suited to Scenes)	35
Viewing a Description (Help Information) of Each Scene	35
Characteristics of Each Scene	36
Using Skin Softening	44
Special Effects Mode (Applying Effects When Shooting)	45

P, S, A, M Modes (Setting the Exposure for Shooting)	48
U1, U2 and U3 (User Settings Modes)	52
Saving Settings in U1, U2 or U3 Mode (Save User Settings)	52
Features That Can Be Set Using the Multi Selector	55
Available Functions	55
Using the Flash (Flash Modes)	56
Using the Self-timer	59
Shooting Smiling Faces Automatically (Smile Timer)	60
Using Focus Mode	62
List of the Default Settings	64
Features That Can Be Set Using the Exposure Compensation Dial	66
Adjusting Brightness (Exposure Compensation)	66
Features That Can Be Set Using the Quick Menu Dial (Shooting Mode)	67
Available Quick Menu	68
Using the Quick Menu	69
Features That Can Be Set Using the MENU (Menu) Button (Shooting Mode)	70
Options Available in the Shooting Menu	71
Available Specialized Menu for U1, U2 or U3	73
Changing the Image Quality and Image Size	75
Available Image Quality	75
Available Image Size	77
Features Not Available in Combination	79
The Control Range of the Shutter Speed	82
Focusing on Subject	84
Using the Target Finding AF	84
Using Face Detection	85
Focus Lock	86
Autofocus	86
Speedlights (External Flash Unit)	87
How to Attach the Speedlight	87
<hr/>	
Playback Features	91
Playback Zoom	91
Viewing Several Images (Thumbnail Playback and Calendar Display)	92
Features That Can Be Set Using the MENU (Menu) button (Playback Mode)	93
Available Playback Menus	93
Using the Screen for Selecting Images	95
Connecting the Camera to a TV, Computer, or Printer	96
Using ViewNX 2	97
Installing ViewNX 2	97
Transferring Images to the Computer	99
Viewing Images	100

Recording and Playing Back Movies.....	101
Recording Movies	101
Features That Can Be Set Using the Quick Menu Dial (Movie Mode, Movie Custom Setting Mode).....	105
Available Quick Menu.....	106
Features That Can Be Set Using the MENU (Menu) Button (Movie Mode, Movie Custom Setting Mode).....	107
Available Movie Menus	108
Playing Back Movies.....	109
<hr/>	
General Camera Setup.....	110
The Setup Menu	110
<hr/>	
Reference Section.....	 1
<hr/>	
Taking Pictures With Manual Focus.....	 2
Using Easy Panorama (Shooting and Playing back)	 3
Taking Pictures with Easy Panorama.....	 3
Viewing Easy Panorama (Scroll).....	 5
Using Panorama Assist.....	 6
Playing Images in a Sequence.....	 8
Editing Still Images.....	 10
Editing Features	 10
 Quick Retouch: Enhancing Contrast and Saturation.....	 12
 D-Lighting: Enhancing Brightness and Contrast	 12
 Skin Softening: Softening Skin Tones	 13
 Filter Effects: Applying Digital Filter Effects	 14
 Small Picture: Reducing the Size of an Image.....	 15
 Black Border: Adding a Black Border to Pictures	 15
 Straighten: Compensating for Picture Slanting.....	 16
NRW NRW (RAW) Processing: Creating JPEG Images from NRW Images.....	 16
 Crop: Creating a Cropped Copy.....	 18
Connecting the Camera to a TV (Viewing Images on a TV)	 19
Connecting the Camera to a Printer (Direct Print)	 21
Connecting the Camera to a Printer.....	 21
Printing Individual Images.....	 22
Printing Multiple Images.....	 23
Editing Movies.....	 26
Extracting Only the Desired Portions of the Movie.....	 26
Saving a Frame from a Movie as a Still Picture	 27

Quick Menu.....		28
QUAL Image Quality and Image Size.....		28
QUAL Movie Options.....		28
ISO Sensitivity.....		31
WB White Balance (Adjusting Hue).....		33
BKT Bracketing (Continuous Shooting While Changing the Exposure and White Balance).....		36
 Picture Control (COOLPIX Picture Control) (Changing the Settings for Image Recording).....		38
Shooting Menu (P, S, A or M Mode).....		42
Custom Picture Control (COOLPIX Custom Picture Control).....		42
Metering.....		43
Continuous Shooting.....		44
AF Area Mode.....		47
Autofocus Mode.....		51
Flash Exp. Comp.....		51
Noise Reduction Filter.....		52
Built-in ND Filter.....		52
Distortion Control.....		53
Active D-Lighting.....		53
Zoom Memory.....		54
Startup Zoom Position.....		54
M Exposure Preview.....		55
Focus-coupled Metering.....		55
Commander Mode.....		56
Specialized Menu for U1, U2 or U3.....		58
Movie and Movie Custom Setting Menus.....		58
Shooting Mode (Movie Custom Setting Only).....		58
Custom Picture Control (Movie Custom Setting Only).....		58
Autofocus Mode.....		59
Built-in ND Filter (Movie Custom Setting Only).....		59
Wind Noise Reduction.....		59
The Playback Menu.....		60
 Print Order (Creating a DPOF Print Order).....		60
 Slide Show.....		62
 Delete.....		63
 Protect.....		64
 Rotate Image.....		64
 Voice Memo.....		65
 Copy (Copy Between Internal Memory and Memory Card).....		66
 Sequence Display Options.....		67
 Choose Key Picture.....		67

The Setup Menu	68
Welcome Screen	68
Time Zone and Date	69
Monitor Settings	71
Print Date (Imprinting Date and Time on Pictures)	72
Self-timer: After Release	73
Vibration Reduction	73
AF Assist	74
ISO Sensitivity Step Value	74
Digital Zoom	75
Zoom Speed	76
Fixed Aperture	76
Sound Settings	77
Record Orientation	77
Rotate Tall	78
Auto Off	78
Format Memory/Format Card	79
Language	79
TV Settings	80
External Mic Sensitivity	80
Customize Command Dials	81
Command Dial Rotation	81
Multi Selector Right Press	81
Delete Button Options	82
AE/AF Lock Button	82
Fn1 + Shutter Button	83
Fn1 + Command Dial/Fn1 + Selector Dial	84
Fn1 Guide Display	85
Fn2 Button	85
Customize My Menu	86
Reset File Numbering	87
GPS Options	87
Eye-Fi Upload	89
MF Distance Indicator Units	90
Reverse Indicators	90
Flash Control	90
Reset All	91
Firmware Version	94
Error Messages	95
File and Folder Names	100
Optional Accessories	102
Shooting with Remote Control ML-L3	104

Technical Notes and Index	 1
<hr/> <hr/>	
Troubleshooting	 2
Caring for the Products	 9
The Camera	 9
The Battery	 10
The Battery Charger	 11
The Memory Cards	 12
Caring for the Camera	 13
Cleaning	 13
Storage	 13
Specifications	 14
Supported Standards	 17
Index	 19

Parts of the Camera and Main Functions

The Camera Body

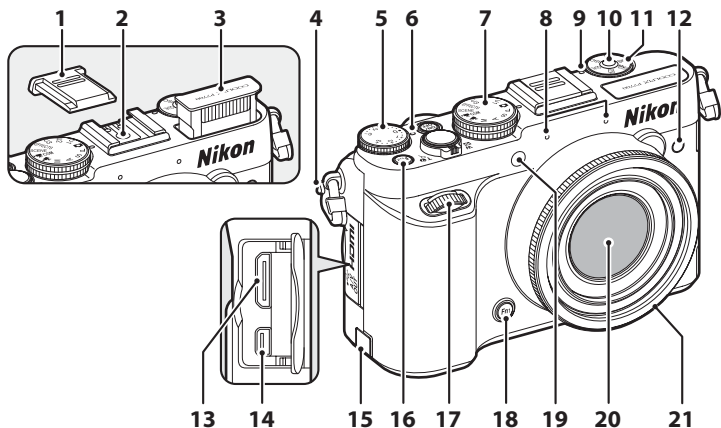







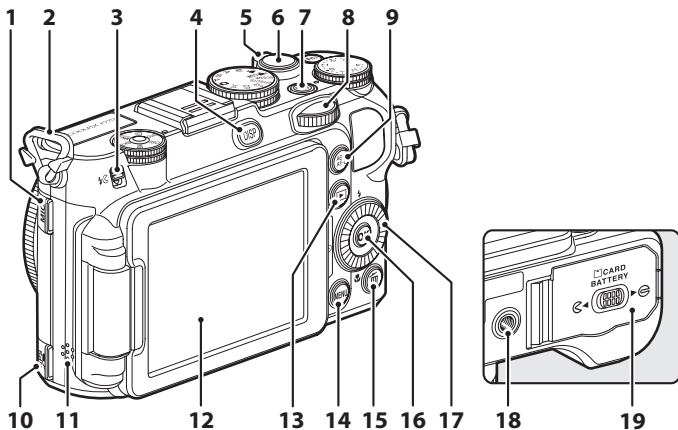



1	Accessory Shoe Cover BS-1.....	87
2	Accessory shoe	87
3	Flash.....	56
4	Eyelet for camera strap.....	7
5	Exposure compensation dial	66
6	Exposure compensation dial mark....	66
7	Mode dial.....	26
8	Microphone (stereo)	94, 101
9	Quick menu dial mark.....	67, 105
10	Quick menu button.....	67, 105
11	Quick menu dial.....	67, 105
12	Infrared receiver (for an optional Remote Control ML-L3)	55, 104

13	HDMI mini connector (Type C)	96
14	USB/Audio video connector.....	96
15	Power connector cover (for an optional AC Adapter).....	103
16	Fn2 (function 2) button.....	113
17	Sub-command dial	3, 5, 48, 50
18	Fn1 (function 1) button	4, 113
19	Self-timer lamp.....	59
19	AF-assist illuminator	111
20	Lens	
21	Lens ring.....	103

The Camera Body





















1	External microphone connector..... 104	10	Accessory terminal  88,  102
2	Eyelet for camera strap7	11	Speaker94, 109, 111
3	  (flash pop-up) control.....56	12	Monitor8, 9, 12
4	DISP (display) button9, 12	13	 (playback) button.....32
5	Zoom control.....29 W : Wide29 T : Tele.....29  : Thumbnail playback.....92  : Playback zoom.....91  : Help35	14	MENU (menu) button70, 107
6	Shutter-release button.....4, 30	15	 (delete) button.....33, 109, 112
7	Power switch/power-on lamp.....23	16	 (apply selection) button10
8	Main command dial.....3, 5, 48, 50	17	Rotary multi selector (multi selector)*3, 5, 55
9	AE-L / AF-L (AE-L/AF-L) button4, 113	18	Tripod socket
		19	Battery-chamber/ memory card slot cover18, 20







* The “rotary multi selector” is also referred to as the “multi selector” in this manual.



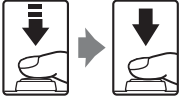

Principle Functions of the Controls

For Shooting







Control	Main Function	
 Mode dial	Change the shooting mode.	26
 Zoom control	Rotate toward T (Q) (telephoto zoom position) to zoom in, and rotate toward W (R) (wide-angle position) to zoom out.	29
 Rotary multi selector	<ul style="list-style-type: none"> While the shooting screen is displayed, display the setting screen for  (flash mode) by pressing up () , for  (self-timer/smile timer/remote control) by pressing left () , for  (focus mode) by pressing down () and for  (AF area mode) by pressing right () . While the setting screen is displayed, select items using , , , or , or by rotating the rotary multi selector. While the setting screen is displayed, apply the selection by pressing the  button. 	55 10 10
 Main command dial	<ul style="list-style-type: none"> Set the flexible program (in shooting mode P) or shutter speed (in shooting mode S or M). While the setting screen is displayed, select an item. 	48, 50 10
 Sub-command dial	<ul style="list-style-type: none"> Set the aperture value (in shooting mode A or M). While the setting screen is displayed, move the menu level. While the quick menu is displayed, select an item. 	48, 50 10 69

The Camera Body









Control	Main Function	
 <p>Quick menu dial, Quick menu button</p>	Display or exit the quick menu.	67, 105
 <p>MENU (menu) button</p>	Display and hide the menu.	10
 <p>Shutter-release button</p>	When pressed halfway (i.e., if you stop pressing when you feel resistance slightly): Set focus and exposure. When pressed all the way (i.e., if you press the button all the way down): Release the shutter.	30
 <p>Exposure compensation dial</p>	Adjust the brightness (exposure compensation).	66
 <p>AE-L AF-L (AE-L/AF-L) button</p>	Lock the exposure or focus.	113
 <p>Fn1 (function 1) button</p>	<ul style="list-style-type: none"> • Combined with the zoom control: Change the zoom lens focal length. • Combined with the shutter-release button: Shoot with the assigned function setting. • Combined with the command dial: Change the assigned function setting. • Combined with the rotary multi selector: Change the assigned function setting. 	72 113 113 113
 <p>Fn2 (function 2) button</p>	Display the setting menu of pre-assigned function.	113

Control	Main Function	
 DISP (display) button	Switch the information displayed on the monitor screen.	9
 Playback button	Play back images.	32
 Delete button	Delete the last image that was saved.	33

For Playback

Control	Main Function	
 Playback button	<ul style="list-style-type: none"> When the camera is turned off, press and hold this button to turn the camera on in playback mode. Return to shooting mode. 	23 32
 Zoom control	<ul style="list-style-type: none"> Enlarge the image when rotated toward T (Q); display image thumbnail or the calendar when rotated toward W (R). Adjust the volume for voice memo and movie playback. 	91, 92 94, 109
 Rotary multi selector	<ul style="list-style-type: none"> While the playback screen is displayed, change the displayed image by pressing up (▲), left (◀), down (▼), right (▶), or by rotating the rotary multi selector. While the setting screen is displayed, select an item by pressing ▲, ▼, ◀ or ▶, or by rotating the rotary multi selector. Move the area to be enlarged. 	32 10 91
 Main command dial	<ul style="list-style-type: none"> Select pictures and date. Switch the magnification of an enlarged image. 	32, 92 91
 Sub-command dial		

The Camera Body

Control	Main Function	
 <p>Apply selection button</p>	<ul style="list-style-type: none"> • Display individual images of a sequence in full-frame. • Scroll an image recorded with Easy panorama. • Play back movies. • Switch from image thumbnail or zoomed image display to full-frame playback mode. • While the setting screen is displayed, apply the selection. 	32,  8 41,  5 109 92 10
 <p>MENU (menu) button</p>	Display and hide the menu.	10
 <p>Delete button</p>	Delete images.	33
 <p>DISP (display) button</p>	Switch the information displayed on the monitor screen.	9
 <p>Shutter-release button</p>	Return to shooting mode.	-

Attaching the Camera Strap

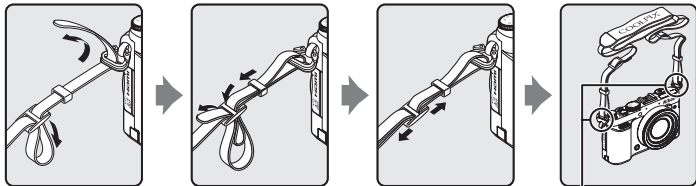

Attach the strap at two places.

Attaching and Detaching the Lens Cap

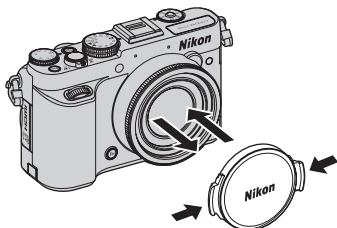

Lens Cap

- Remove the lens cap before you shoot a picture.
- At times when you are not shooting pictures such as when the power is off, or while you are carrying the camera, attach the lens cap to the camera to protect the lens.

Opening and Adjusting the Angle of the Monitor

The orientation and tilt of the monitor on the camera can be changed. This is useful when shooting with the camera in a high or a low position, or when taking self-portraits.

For normal shooting, fold the monitor screen against the camera face out (③).

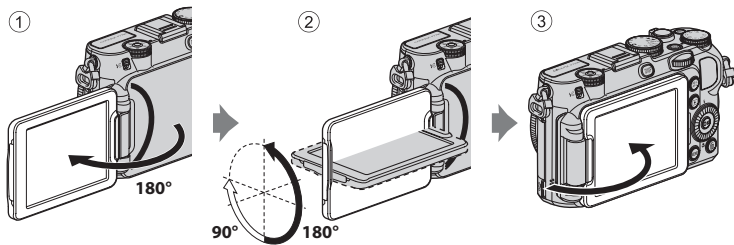

When you are not using or carrying the camera, fold the monitor with the screen facing the camera body to prevent scratches or contamination.

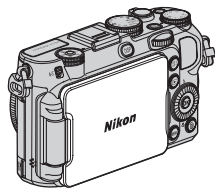

✓ Notes on Monitor

- When moving the monitor, do not apply excessive force and turn slowly within the monitor's adjustable range so that the connection will not be damaged.
- When the monitor is turned with a cable connected to the external microphone connector or accessory terminal, the monitor may catch on the cable or cover. Do not apply excessive force to the cable or to the connector of the camera.

📄 More Information

See "Closing the Monitor and Power" (📖23) for more information.

Switching the Monitor Screen (DISP Button)

To switch the information displayed on the monitor screen during shooting and playback, press the **DISP** (display) button.

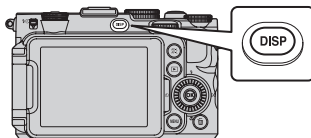

For Shooting

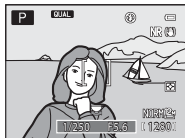

Display information

Display the picture and the shooting information.



Information hidden

Display the picture only.

For Playback

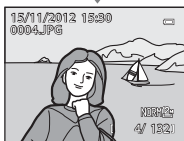

Display photo information

Display the picture and photo information.

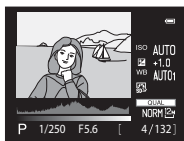

Tone level information* (excluding movies)

Display a histogram, tone level and shooting information.



Information hidden

Display the picture only.

* See 15 for more information on tone level information.

Virtual Horizon, Histogram and Framing Grid Displays for Shooting

- The display options for the monitor screen can be changed in **Photo info** of **Monitor settings** in the setup menu (110). A virtual horizon, histogram and framing grid are available as the display options (12).
- The setting for virtual horizon display can be changed in **Virtual horizon display** of **Monitor settings** in the setup menu. The default setting is **Circle**.

Basic Menu Operations

Once the menu is displayed, various settings can be changed.

1 Press the MENU button.

- The menu that matches the status of the camera, such as shooting or playback mode, is displayed.

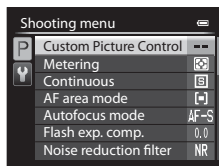
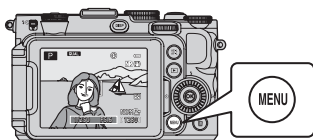

2 Use the rotary multi selector to select a menu item.

- ▲ or ▼: Select an item above or below. An item can also be selected by rotating the multi selector.
- ◀ or ▶: Select an item on the left or right, or move the menu level.
- OK: Apply a selection. Pressing ▶ also applies a selection.
- See 11 for more information on how to switch tabs.



Apply selection

3 After completing the settings, press the MENU button or shutter-release button.

- Press the shutter-release button to display the shooting screen.

Note on the Command Dial Operation When Menus are Displayed

Rotating the main command dial when menus are displayed allows you to select an item. Rotating the sub-command dial allows you to move the menu level.

Switching Among Menu Tabs

To display a different menu, such as the setup menu (📖110), use the multi-selector to switch to another tab.

Tabs

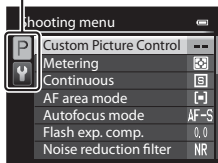

Press ◀ to move to the tab.

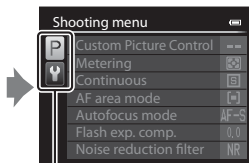

Press ▲ or ▼ to select the tab, and press the OK button or ▶ to apply the selection.

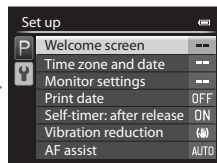

Tab Types

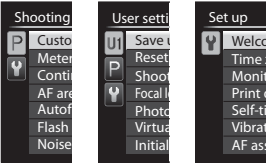
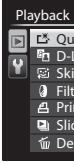





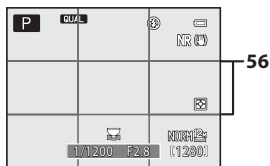
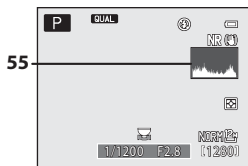
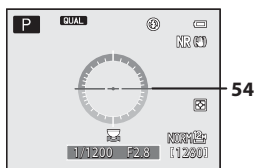
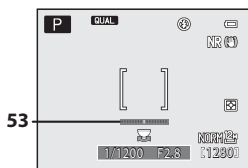
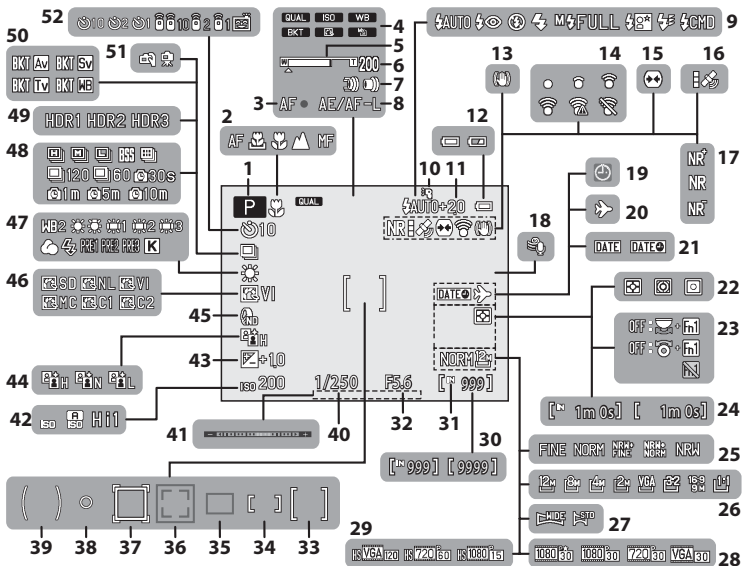

For Shooting	For Playback
	
<p>P tab: Displays the settings available for the current shooting mode (📖27). Depending on the current shooting mode, the tab icon that is displayed will be different. In 📷 (auto) mode, only Y tab is displayed.</p> <p>U1/U2/U3 tab: Displays the settings for the specialized menu in U1, U2 or U3 mode (📖52).</p>	<p>P tab: Displays the settings available for the playback mode.</p>
<p>Y tab: Displays the setup menu, where you can change general settings.</p>	

Monitor Screen

The information that is displayed on the monitor during shooting and playback changes depending on the camera's settings and state of use. Press the **DISP** (display) button to hide or show the information on the monitor ()9).

For Shooting



1	Shooting mode.....	26, 27	32	Aperture value	48
2	Focus mode.....	63	33	Focus area (for center)	55, 64, 71, 86
3	Focus indicator	30	34	Focus area (for manual)	38, 39, 43, 55, 64, 71
4	Quick menu dial indicator.....	67, 105	35	Focus area (for auto, target finding AF)	30, 31, 55, 64, 71, 84
5	Zoom indicator	29, 63	36	Focus area (for face detection, pet detection)	42, 55, 60, 64, 71, 85
6	Zoom memory	72	37	Focus area (for subject tracking)	55, 64, 71
7	Zoom speed setting.....	111	38	Spot metering area.....	71
8	AE/AF-L indicator.....	43, 113, 	39	Center-weighted area	71
9	Flash mode	57	40	Shutter speed.....	48
10	Speedlight.....	87	41	Exposure indicator	50
11	Flash exp. comp.....	71	42	ISO sensitivity	68, 106
12	Battery level indicator	22	43	Exposure compensation value.....	66
13	Vibration reduction icon	111	44	Active D-Lighting.....	72
14	Eye-Fi communication indicator	114, 	45	Built-in ND filter.....	72
15	Distortion control	72	46	COOLPIX Picture Control.....	68, 106
16	GPS reception	114, 	47	White balance	68, 106
17	Noise reduction filter.....	71	48	Continuous shooting mode.....	42, 71
18	Wind noise reduction.....	108	49	Backlighting (HDR)	40
19	"Date not set" indicator.....	25, 110	50	Auto bracketing.....	68
20	Travel destination indicator.....	110		Hand-held/Tripod.....	38
21	Print date.....	110	51	Self-timer	59
22	Metering.....	71		Remote control	55
23	Fn1 guide display.....	4, 113	52	Smile timer	60
24	Movie length	101, 		Pet portrait auto release	42
25	Image quality	75	53	Virtual horizon (bars).....	110, 
26	Image size.....	75, 77	54	Virtual horizon (circle)	110, 
27	Easy panorama	41	55	View/hide histograms.....	110, 
28	Movie options (normal speed movies)	101, 106	56	View/hide framing grid.....	110, 
29	Movie options (HS movies).....	101, 106			
30	Number of exposures remaining (still pictures).....	22, 78			
31	Internal memory indicator.....	22			





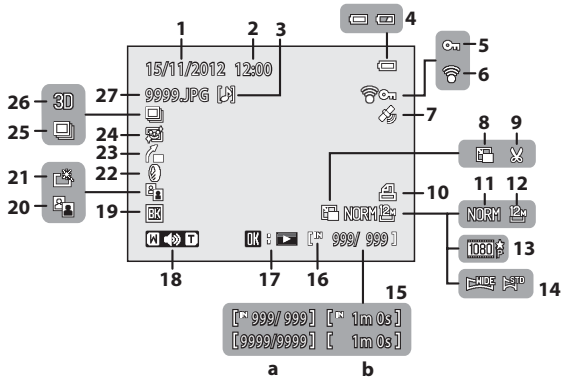

For Playback

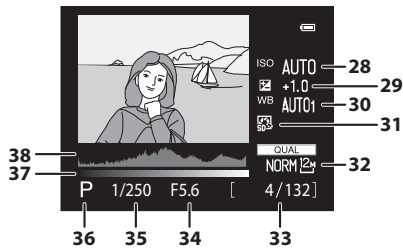
Full-frame display (📖32)





Tone level information display¹ (📖9)



1	Date of recording.....	24	20	D-Lighting icon	93
2	Time of recording	24	21	Quick retouch icon.....	93
3	Voice memo indicator.....	94	22	Filter effects icon.....	93
4	Battery level indicator	22	23	Straighten indicator.....	94
5	Protect icon.....	93	24	Skin softening icon.....	93
6	Eye-Fi communication indicator	114, 	25	Sequence display (when Individual pictures is set)	 8
7	Recorded GPS information indicator	114	26	3D image indicator	43
8	Small picture	93, 	27	File number and type	 100
9	Crop.....	91, 	28	ISO sensitivity.....	68
10	Print order icon.....	93	29	Exposure compensation value.....	66
11	Image quality.....	75	30	White balance	68
12	Image size.....	77	31	COOLPIX Picture Control.....	68
13	Movie options.....	101, 106	32	Image quality/Image size.....	75
14	Easy panorama indicator	41	33	Current image number/ total number of images	32
15	(a) Current image number/total number of images.....	32	34	Aperture value	31
	(b) Movie length	109	35	Shutter speed.....	31
16	Internal memory indicator	32	36	Shooting mode ²	27
	Easy panorama playback guide	 5	37	Tone level ³	
17	Sequence playback guide	 8	38	Histogram ⁴	
	Movie playback guide	109			
18	Volume indicator	94, 109			
19	Black border indicator	94			

¹ You can check for loss of contrast detail in highlights and shadows from the histogram that is displayed, or the flashing display for each tone level. These provide guidelines when adjusting the picture brightness with functions such as exposure compensation.

² **P** is displayed when the shooting mode , **SCENE, EFFECTS** or **P** is selected.

³ The tone level indicates the brightness level. When the tone level to check is selected by pressing the rotary multi selector  or , the area of the picture that corresponds to the selected tone level flashes.

⁴ A histogram is a graph showing the distribution of tones in the image. The horizontal axis corresponds to pixel brightness, with dark tones to the left and bright tones to the right. The vertical axis shows the number of pixels.

The Basics of Shooting and Playback

Preparation 1 Charge the Battery

1 Prepare the included Battery Charger MH-24.

If a plug adapter* is included with your camera, attach the plug adapter to the plug on the Battery Charger. Push the plug adapter firmly until it is securely held in place. Once the two are connected, attempting to forcibly remove the plug adapter could damage the product.

* The shape of the plug adapter varies according to the country or region in which the camera was purchased.

The Battery Charger comes with the plug adapter attached in Argentina and Korea.

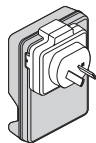
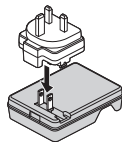

2 While pushing in the battery (①), set it into the Battery Charger (②).

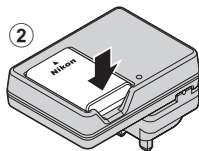
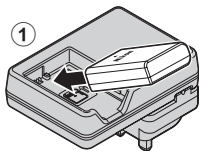

3 Plug the Battery Charger into an electrical outlet.

- CHARGE lamp starts flashing when charging starts.
- A fully-exhausted battery charges in about 1 hour and 30 minutes.
- When charging is complete, the CHARGE lamp stops flashing.
- See "Understanding CHARGE Lamp" (17).

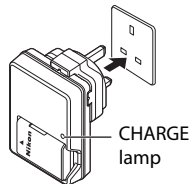

4 When charging is complete, remove the battery and then disconnect the Battery Charger from the electrical outlet.

Understanding CHARGE Lamp

Status	Description
Flashes	The battery is charging.
On	The battery is fully charged.
Flashes quickly	<ul style="list-style-type: none"> The battery is set incorrectly. Disconnect the Battery Charger from the electrical outlet, remove the battery, and then reset the battery to lie flat in the Battery Charger. The ambient temperature is not suited to charging. Charge the battery indoors with an ambient temperature of 5°C to 35°C (41°F to 95°F). There is a problem with the battery. Immediately disconnect the Battery Charger from the electrical outlet, and stop charging. Take the battery and Battery Charger to your retailer or Nikon-authorized service representative.

Notes on Battery Charger

- Be sure to read and follow the warnings of “For Your Safety” (📖vi) thoroughly before using the Battery Charger.
- Be sure to read and follow the warnings for “The Battery Charger” (🔌11) thoroughly before using the battery.

Notes on Battery

- Be sure to read and follow the warnings of “For Your Safety” (📖vi) thoroughly before using the battery.
- Be sure to read and follow the warnings for “The Battery” (🔋10) thoroughly before using the battery.

AC Power Supply

- If the AC Adapter EH-5b and the Power Connector EP-5A (available separately) (🔌103) are used, power is supplied to the camera from an electrical outlet, enabling taking and playing back pictures.
- Do not, under any circumstances, use an AC Adapter other than the EH-5b or a Power Connector other than the EP-5A. Failure to observe this precaution could result in overheating or damage to the camera.

Preparation 2 Insert the Battery

- 1 Open the battery-chamber/memory card slot cover.

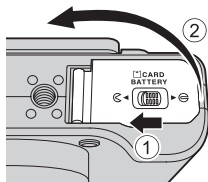

- 2 Insert the battery.

- Use the battery to push the orange battery latch in the direction shown (①), and fully insert the battery (②).
- When the battery is inserted correctly, the battery latch will lock the battery in place.

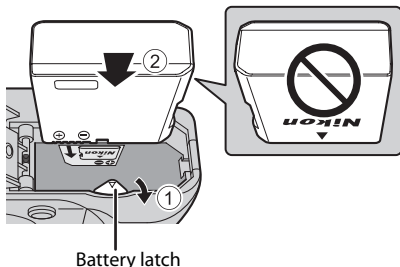

Battery latch

✓ Inserting the Battery Correctly

Inserting the battery upside down or backwards could damage the camera. Be sure to confirm that the battery is in the correct orientation.

- 3 Close the battery-chamber/memory card slot cover.

- While the battery-chamber/memory card slot cover is open, the camera cannot be turned on.

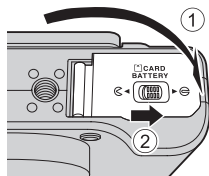

Removing the Battery

Before opening the battery-chamber/memory card slot cover, turn the camera off (📖23) and confirm that the power-on lamp and the monitor are off.

To eject the battery, open the battery-chamber/memory card slot cover and push the orange battery latch in the direction shown (①). Then, remove the battery straight (②).

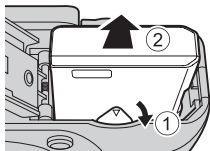

High Temperature Caution

The camera, battery, and memory card may be hot immediately after using the camera. Observe caution when removing the battery or memory card.

Preparation 3 Insert a Memory Card

- 1 Confirm that the power-on lamp and the monitor are turned off and open the battery-chamber/memory card slot cover.
 - Be sure to turn off the camera before opening the cover.

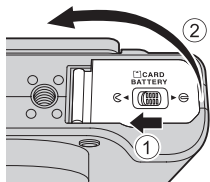

- 2 Insert the memory card.
 - Slide the memory card until it clicks into place.

✓ Inserting the Memory Card Correctly

Inserting the memory card upside down or backwards could damage the camera or the memory card. Be sure to confirm that the memory card is in the correct orientation.

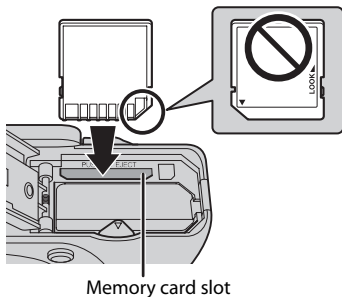

- 3 Close the battery-chamber/memory card slot cover.
 - Be sure to turn off the camera before opening the cover.

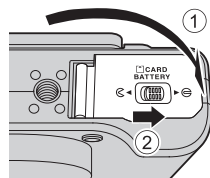

✓ Formatting a Memory Card

- The first time you insert a memory card that has been used in another device into this camera, be sure to format it with this camera.
- **All data stored on a memory card is permanently deleted when the card is formatted.** Be sure to make copies of any data you wish to keep before formatting the memory card.
- To format a memory card, insert the memory card into the camera, press the **MENU** button and select **Format card** from the setup menu (📖110).

✓ Note on Memory Cards

Refer to the documentation included with the memory card, as well as “The Memory Cards” (🔍12) in “Caring for the Products”.

Removing Memory Cards

Before opening the battery-chamber/memory card slot cover, turn the camera off and confirm that the power-on lamp and the monitor are off.

Press the memory card in lightly with your finger (①) to partially eject it, and then pull it out straight (②).

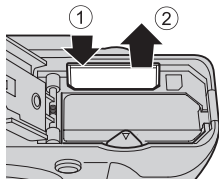

High Temperature Caution

The camera, battery, and memory card may be hot immediately after using the camera. Observe caution when removing the battery or memory card.

Internal Memory and Memory Cards

Camera data, including images and movies, can be saved in either the camera's internal memory (approximately 86 MB) or on a memory card. To use the camera's internal memory for shooting or playback, first remove the memory card.

Approved Memory Cards

The following Secure Digital (SD) memory cards have been tested and approved for use in this camera.

- When recording a movie onto a memory card, a memory card with an SD speed class of Class 6 or higher is recommended. If the transfer speed of the card is slow, the movie recording may end unexpectedly.

	SD memory cards	SDHC memory cards ²	SDXC memory cards ³
SanDisk	2 GB ¹	4 GB, 8 GB, 16 GB, 32 GB	64 GB, 128 GB
TOSHIBA	2 GB ¹	4 GB, 8 GB, 16 GB, 32 GB	64 GB
Panasonic	2 GB ¹	4 GB, 8 GB, 16 GB, 32 GB	64 GB
Lexar	-	4 GB, 8 GB, 16 GB, 32 GB	64 GB, 128 GB

- Before using a card reader or similar device, check that the device supports 2 GB cards.
- SDHC-compliant. Before using a card reader or similar device, check that the device supports SDHC.
- SDXC-compliant. Before using a card reader or similar device, check that the device supports SDXC.

- Contact the manufacturer for details on the above cards.



Step 1 Turn the Camera On

1 Open the monitor and remove the lens cap.

- See “Opening and Adjusting the Angle of the Monitor” (📖8) for more information.
- See “Attaching the Camera Strap” (📖7) for more information.

2 Press the power switch to turn on the camera.

- **If you are turning the camera on for the first time, see “Setting the Display Language, Date, and Time” (📖24).**
- The lens extends, and the monitor is turned on.

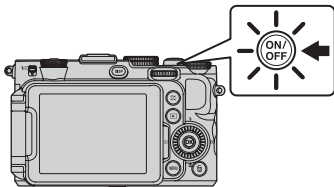

3 Check the battery level and number of exposures remaining.

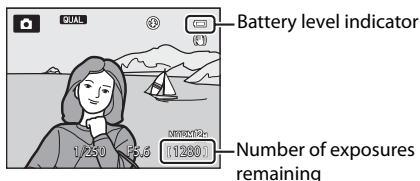

Battery Level

Display	Description
	Battery level high.
	Battery level low. Prepare to charge or replace the battery.
 Battery exhausted.	Cannot take pictures. Charge or replace the battery.

Number of Exposures Remaining

The number of exposures remaining is displayed.

- When a memory card is not inserted, is displayed and pictures are recorded to the internal memory (approx. 86 MB).
- The number of pictures that can be stored depends on the remaining capacity of the internal memory or memory card, the image quality, and the image size (📖78).
- The number of exposures remaining shown in the illustration differs from the actual value.

Turning the Camera On and Off



- When the camera is turned on, the power-on lamp (green) lights and the monitor is turned on (the power-on lamp turns off when the monitor is turned on).
- To turn off the camera, press the power switch. Both the monitor and the power-on lamp are turned off.
- To turn on the camera in playback mode, press and hold the  (playback) button. At this time, the lens does not extend.

Closing the Monitor and Power

- When the monitor is closed with the screen facing inward, the power cannot be turned on even if the power switch or  button is pressed.
- When the monitor is closed with the screen facing inward while the power is on, the camera enters standby mode and the power lamp flashes on and off. After the monitor is in the closed position for 3 minutes, the power turns off. Opening the monitor when the camera is in standby mode causes it to switch to the shooting mode.
- When the monitor is closed while movie recording or interval timer shooting, recording will end.
- When the camera is connected to a TV, PC or printer, the camera will not enter standby mode when the monitor is closed.

Power Saving Function (Auto Off)

If no operations are performed for a while, the monitor will turn off, the camera will enter standby mode, and the power-on lamp will flash. If no operations are performed for another 3 minutes, the camera will turn off automatically.

- To turn on the monitor again in standby mode, perform either one of the following operations.
 - Press the power switch, shutter-release button or the  button.
 - Rotate the mode dial.
- The time that elapses before the camera enters standby mode can be changed using the **Auto off** setting in the setup menu ( 110).
- By default, the camera enters standby mode in about 1 minute when you are using shooting mode or playback mode.
- If you are using the AC Adapter EH-5b (available separately), the camera enters standby mode after 30 minutes. This setting cannot be changed.

Monitor Display

Press the **DISP** button to switch between showing and hiding the photo information or shooting information that is displayed on the monitor screen ( 9).

Setting the Display Language, Date, and Time

Dialogs for language selection and camera clock setting are displayed the first time the camera is turned on.

- 1 Press the multi selector ▲ or ▼ to choose the desired language and press the **OK** button.

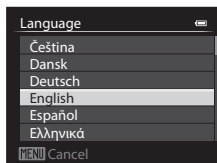

- 2 Press ▲ or ▼ to choose **Yes** and press the **OK** button.

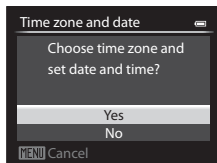

- 3 Press ◀ or ▶ to select your home time zone (Time zone), and press the **OK** button.

- In regions where daylight saving time applies, press ▲ to enable the daylight saving time function. ☀ will be displayed. To disable the daylight saving time function, press ▼.

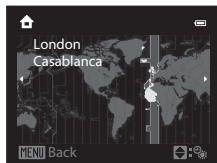

- 4 Press ▲ or ▼ to choose the date display order and press the **OK** button or ▶.

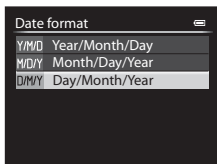

5 Press ▲, ▼, ◀ or ▶ to set date and time, and press the **OK** button.

- Choose an item: Press ▶ or ◀ (selected in the following order: **D** (day) → **M** (month) → **Y** (year) → **hour** → **minute**).
- Set the contents: Press ▲ or ▼. Date and time can also be set by rotating the multi selector or main command dial.
- Confirm the settings: Select the **minute** field and press the **OK** button or ▶.

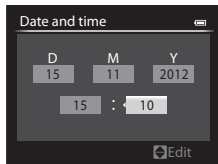

6 Press ▲ or ▼ to choose **Yes** and press the **OK** button.

- After finishing the setting, the lens extends slightly and the shooting screen is displayed.

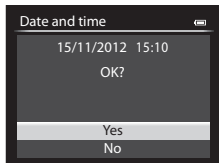

The Clock Battery

- The camera's clock is powered by a backup battery that is separate from the camera's main battery.
- The backup battery charges after about 10 hours of charging when the main battery is inserted into the camera or when the camera is connected to an optional AC Adapter, and can store the set date and time for several days.
- If the camera's backup battery becomes exhausted, the date and time setting screen is displayed when the camera is turned on. Set the date and time again. See step 2 of "Setting the Display Language, Date, and Time" (1124) for more information.

Changing the Language Setting and the Date and Time Setting



- You can change these settings using the **Language** and **Time zone and date** settings in **Y** setup menu (1110).
- In the **Time zone** setting of **Time zone and date** in **Y** setup menu, when the daylight saving time function is enabled, the camera's clock is set forward by one hour, and when disabled, set back by one hour.
- If you exit without setting the date and time,  flashes when the shooting screen is displayed. Use the **Time zone and date** setting in the setup menu to set the date and time.

Imprinting the Shooting Date in Printed Images



- Set the date and time before shooting.
- You can imprint the shooting date in images as they are captured by setting **Print date** in the setup menu.
- If you want the shooting date to be printed without using the **Print date** setting, print using the ViewNX 2 software (1197).

Step 2 Select a Shooting Mode

Rotate the mode dial to select the shooting mode.

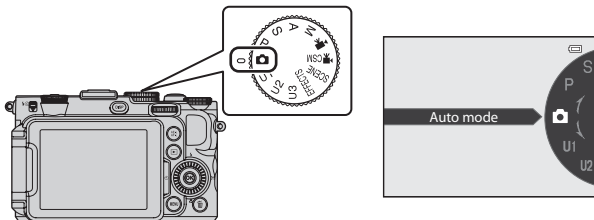
- The following describes how to take pictures in  (auto) mode as an example. Rotate the mode dial to .



- The camera switches to  (auto) mode and the shooting mode icon changes to .

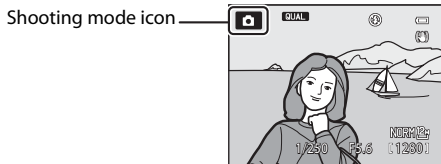

- See “Monitor Screen” ( 12) for more information.

Note on the Flash

In situations where a flash is needed, such as in dark locations or when the subject is backlit, be sure to raise the flash ( 56).

Available Shooting Modes

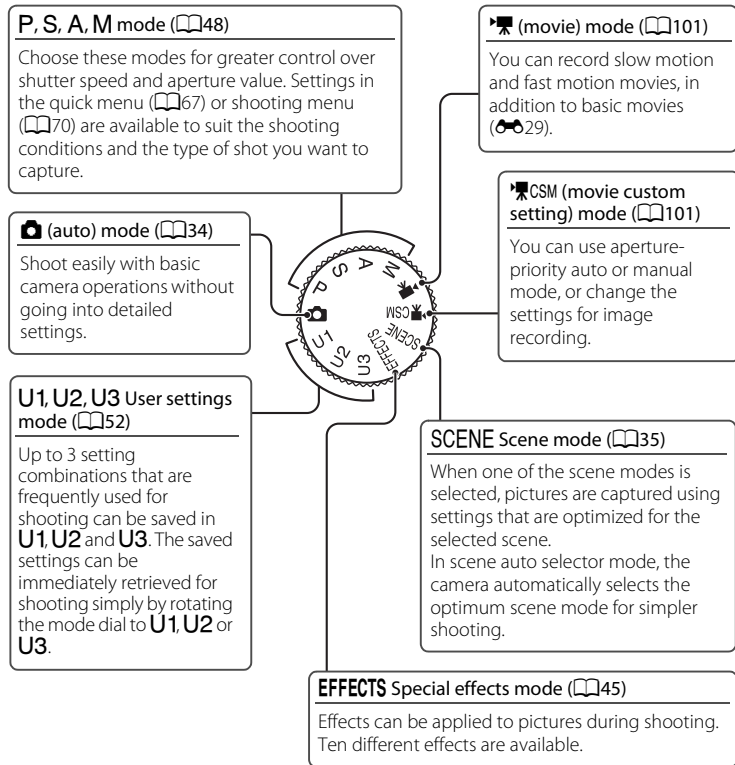

Changing the Settings When Shooting

- Features That Can Be Set Using the Multi Selector → 📖55
- Exposure Compensation → 📖66
- Features That Can Be Set Using the Quick Menu Dial → 📖67, 📖105
- Features That Can Be Set Using the **MENU** (Menu) Button
 - Shooting menu → 📖70, 📖107
 - Setup menu → 📖110

Step 3 Frame a Picture

1 Ready the camera.

- Keep your fingers, hair, strap and other objects away from the lens, flash, AF-assist illuminator and microphone.
- To shoot in the "tall" orientation, hold the camera so that the flash is above the lens.

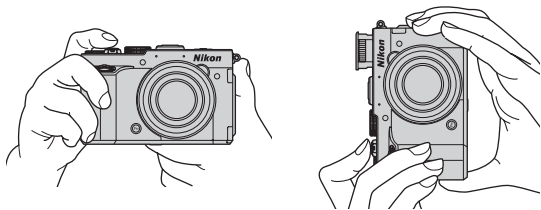

2 Frame the picture.

- Point the camera at the subject.

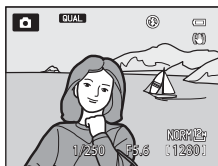

Using a Tripod

- In the following situations, use of a tripod is recommended to avoid the effects of camera shake:
 - When shooting in a dark location with the flash lowered, or in a mode in which flash is disabled
 - When shooting in the telephoto zoom position
- To take a picture with the camera attached to a tripod, set **Vibration reduction** in the setup menu (📖110) to **Off**.

Using the Zoom

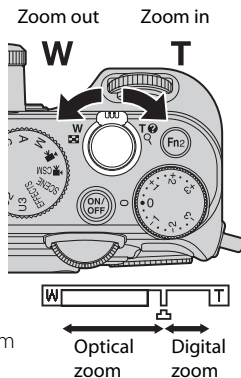

Rotate the zoom control to activate the optical zoom.

- To zoom in so that the subject fills a larger area of the frame, rotate toward **T** (telephoto zoom position).
- To zoom out so that the area visible increases in the frame, rotate toward **W** (wide-angle position).





- Amount of zoom is displayed at the top of the monitor screen when the zoom control is rotated.
- Rotating the zoom control toward **T** at the maximum optical zoom ratio triggers the digital zoom and the digital zoom can magnify by 4x beyond the maximum magnification of the optical zoom.

Digital Zoom and Interpolation

When the digital zoom is used, the image quality starts to deteriorate if the zoom position is increased beyond the  position on the zoom bar. The  position moves to the right as the image size () becomes smaller.

- Using **Digital zoom** in the setup menu () , it is possible to restrict the magnification of the digital zoom to a range where images do not deteriorate, or to set the digital zoom so that it does not operate.

More Information

- Zoom memory → 
- Startup zoom position → 
- Zoom speed → 

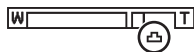

Step 4 Focus and Shoot

1 Press the shutter-release button halfway to adjust the focus.

- “Pressing halfway” is the action of pressing the shutter-release button slightly until you feel resistance and then holding in that position.
- When the subject is in focus, the focus area or focus indicator (📖12) lights in green. If the focus area or focus indicator flashes in red, the subject is out of focus. Press the shutter-release button halfway again.
- See “Focus and Exposure” (📖31) for more information.

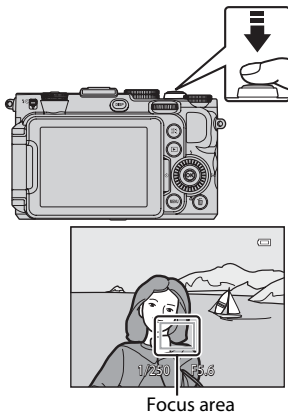

2 Press the shutter-release button all the way to take a picture.

- “Pressing all the way” is the action of pressing the shutter-release button the rest of the way down.



✔ Note on Recording Images and Saving Movies

The indicator showing the number of exposures remaining or the indicator showing the maximum movie length flashes while images are being recorded or while a movie is being saved. **Do not open the battery-chamber/memory card slot cover or remove the battery or memory card while an indicator is flashing.** Doing this could result in loss of data, or in damage to the camera or the memory card.

📎 AF-assist Illuminator

In dark places, the AF-assist illuminator (📖111) may light when the shutter-release button is pressed halfway.

📎 To Make Sure You Do Not Miss a Shot

If you are concerned that you might miss a shot, press the shutter-release button all the way without first pressing it halfway.

Focus and Exposure

When the shutter-release button is pressed halfway, the camera sets the focus and exposure (combination of shutter speed and aperture value). The focus and exposure remain locked while the shutter-release button is pressed halfway.

- When the digital zoom is in effect, the camera focuses on the subject at the center of the frame, and the focus area is not displayed. When the subject is in focus, the focus indicator lights in green.
- The camera may not be able to focus on certain subjects. See “Autofocus” (📖86) for more information.
- In auto mode, the camera automatically selects the areas containing the subject closest to the camera out of 9 focus areas. When the subject is in focus, the focus areas that are in focus (up to 9 areas) light in green.

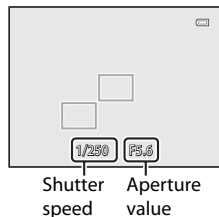

- When **P**, **S**, **A**, **M**, **U1**, **U2**, **U3** or **EFFECTS** (special effects) mode is selected, the areas to be used for focusing can be set using **AF area mode** (📖71) in the shooting menu.
- The areas to be used for focusing in scene mode vary depending on the selected scene (📖36).

✔ The Subject Is Too Close to the Camera

If the camera does not focus, try shooting with 📷 (close range only), 🌸 (macro close-up) (📖63) in the focus mode, or **Close-up** (📖38) scene mode.

📌 More Information

See “Focusing on Subject” (📖84) for more information.





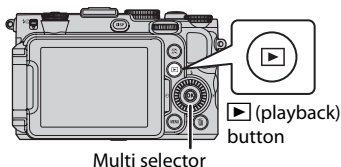

Step 5 Play Back Images

1 Press the (playback) button.

- When you switch from shooting mode to playback mode, the last image saved will be displayed in full-frame playback mode.







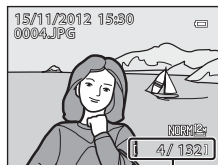

2 Use the multi selector to view previous or next images.

- To view previous images:  or 
- To view next images:  or 
- Images can also be selected by rotating the multi selector or command dial.
- To play back images that are saved in the internal memory, remove the memory card.  is displayed around "Current image number/total number of images" on the playback screen.
- To return to shooting mode, press the  button again or press the shutter-release button.



Current image number/
Total number of images

Viewing Pictures



- Press the **DISP** button to switch between showing and hiding the photo information or shooting information that is displayed on the monitor screen (9).
- When the orientation of the camera is changed during playback, the displayed images are rotated automatically.
- Pictures taken in "tall" orientation will be rotated automatically (111).
- The orientation of an image can be changed using **Rotate image** in the playback menu (93).
- Press the  button to display a sequence of images shot continuously as individual images. Press  on the multi selector to return to the original display (see 8 for more information on the sequence display).
- Images may be displayed at low resolution immediately after switching to the previous or next image.

Step 6 Delete Unwanted Images

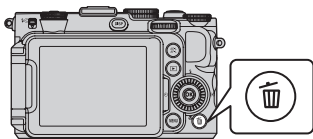
- 1 Press the  button to delete the image currently displayed on the monitor.







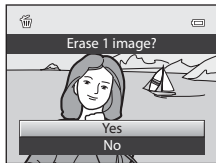

- 2 Press the multi selector  or  to select **Yes** and press the  button.

- Deleted images cannot be recovered.
- To cancel, press  or  to select **No** and press the  button.



Notes on Deletion

- Deleted images cannot be recovered. Transfer important images to a computer before deleting them.
- Protected images (93) cannot be deleted.
- When pictures taken with an **Image quality** (75) setting of **NRW (RAW) + Fine** or **NRW (RAW) + Normal** are deleted with the  button, both the NRW (RAW) and JPEG images that were recorded at the same time are deleted.
To delete only NRW (RAW) images or JPEG images, select **Erase selected NRW images** or **Erase selected JPEG images** in **Delete** of the playback menu (93).
- When images are taken with continuous shooting, each series of images is treated as a group (pictures in a sequence) and only the group's "key picture" is displayed in the default setting. When you press the  button during key picture playback, all images in the key picture's sequence can be deleted.
To delete each picture in a sequence, before pressing the  button, press the  button to display each image in the sequence individually.

Deleting the Last Image Captured While in Shooting Mode

When using shooting mode, press the  button to delete the last image that was saved.

Deleting Multiple Images

To delete multiple images, select **Delete** from the playback menu (93).

Shooting Features

(Auto) Mode



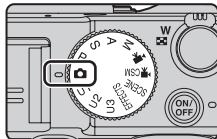

Shoot easily with basic camera operations without going into detailed settings.

The camera selects the focus area for autofocus in accordance with the composition or subject.

- The camera automatically selects the areas containing the subject closest to the camera out of 9 focus areas. When the subject is in focus, the focus areas that are in focus (up to 9 areas) light in green.
- See “Focus and Exposure” (31) for more information.



Changing (Auto) Mode Settings

- Features That Can Be Set Using the Multi Selector → 55
- Exposure Compensation → 66
- Changing the Image Quality and Image Size → 75
- Features That Can Be Set Using the **MENU** (Menu) Button
 - Setup menu → 110

Scene Mode (Shooting Suited to Scenes)

Press the **MENU** button and display the scene menu to select one of the following scenes. Pictures are captured using settings that are optimized for the selected scene.

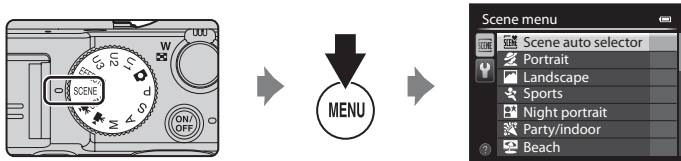

Scene auto selector (default setting) (📖36)	Night landscape (📖38)
Portrait (📖36)	Close-up (📖38)
Landscape (📖37)	Food (📖39)
Sports (📖37)	Museum (📖39)
Night portrait (📖37)	Fireworks show (📖39)
Party/indoor (📖37)	Black and white copy (📖39)
Beach (📖37)	Backlighting (📖40)
Snow (📖37)	Panorama (📖41)
Sunset (📖37)	Pet portrait (📖42)
Dusk/dawn (📖38)	3D 3D photography (📖43)

Viewing a Description (Help Information) of Each Scene

Select the desired scene from the scene menu and rotate the zoom control (📖2) toward **T** (🔍) to view a description of that scene. To return to the original screen, rotate the zoom control toward **T** (🔍) again.



More Information

See "Basic Menu Operations" (📖10) for more information.

Changing Scene Mode Settings

- Features That Can Be Set Using the Multi Selector → 📖55
- Exposure Compensation → 📖66
- Changing the Image Quality and Image Size → 📖75
- Features That Can Be Set Using the **MENU** (Menu) Button
 - Setup menu → 📖110











Characteristics of Each Scene

- Use of a tripod is recommended in scene modes with  indicated due to slow shutter speed.
- Set **Vibration reduction** in the setup menu (📖110) to **Off** when using a tripod to stabilize the camera.
- For scene modes that use the flash, lower the   (flash pop-up) control to raise the flash (📖56).

Scene auto selector

When you frame a picture, the camera automatically selects the optimum scene for simpler shooting.

- When the camera automatically selects a scene mode, the shooting mode icon changes to that for the scene mode currently enabled.

Portrait	 : The camera performs the optimal operation for shooting a close-up picture of one to two persons.  : The camera performs the optimal operation for shooting a picture of three or more persons or shooting a composition with a large background area.
Landscape	 : The camera performs the optimal operation for shooting a landscape picture.
Night portrait	 : The camera performs the optimal operation for shooting a close-up picture of one to two persons.  : The camera performs the optimal operation for shooting a picture of three or more persons or shooting a composition with a large background area.
Night landscape	 : The camera shoots images continuously and combines and saves them as one image, just as when Hand-held in Night landscape (📖38) is selected.
Close-up	 : The camera performs the optimal operation for shooting a close-up picture.
Backlighting	 : The camera performs the optimal operation for shooting non-human subjects.  : The camera performs the operation using face detection that is optimal for shooting human subjects.
Other scenes	

- The camera automatically selects the focus area for autofocus in accordance with the composition. The camera detects and focuses on faces (📖85).
- The digital zoom is not available.

Note on Selecting a Scene Mode Using Scene Auto Selector

Depending upon shooting conditions, the camera may not select the desired scene mode. Should this occur, switch to  (auto) mode (📖26) or select the optimum scene mode for the subject manually.

Portrait

- The camera detects and focuses on a face (📖85).
- The skin softening feature makes the subject's skin appear softer (📖44).
- If no faces are detected, the camera focuses on the subject at the center of the frame.
- The digital zoom is not available.

 Landscape

- When the shutter-release button is pressed halfway, the camera adjusts the focus to infinity. The focus area or focus indicator (📄12) always lights in green.

 Sports

- The camera focuses at the center area of the frame.
- When you continue to hold the shutter-release button all the way down, up to about 6 pictures are shot at a rate of about 8 frames per second (fps) (when image quality is set to **Normal** and image size is set to 📄 4000×3000).
- The camera focuses the subject even when the shutter-release button is not pressed halfway. You may hear the sound of the camera focusing.
- Focus, exposure, and hue are fixed at the values determined with the first image in each series.
- The frame rate with continuous shooting may become slow depending upon the current image quality setting, image size setting, the memory card used, or shooting condition.

 Night portrait

- The flash always fires. Raise the flash before shooting.
- The camera detects and focuses on a face (📄85).
- The skin softening feature makes the skin tones in people's faces appear softer (📄44).
- If no faces are detected, the camera focuses on the subject at the center of the frame.
- The digital zoom is not available.

 Party/indoor

- The camera focuses at the center area of the frame.
- As images are easily affected by camera shake, hold the camera steadily. Set **Vibration reduction** to **Off** in the setup menu (📄110) when shooting using a tripod to stabilize the camera.

 Beach

- The camera focuses at the center area of the frame.

 Snow

- The camera focuses at the center area of the frame.

 Sunset







- When the shutter-release button is pressed halfway, the camera adjusts the focus to infinity. The focus area or focus indicator (📄12) always lights in green.

Dusk/dawn











- When the shutter-release button is pressed halfway, the camera adjusts the focus to infinity. The focus area or focus indicator (12) always lights in green.

Night landscape

- From the screen displayed after  **Night landscape** is selected, select  **Hand-held** or  **Tripod**.
-  **Hand-held** (default setting): This enables you to shoot with the minimum of camera shake and noise even when holding the camera by hand.
 - When the shutter-release button is pressed all the way, pictures are shot continuously, and the camera combines these pictures to save a single picture.
 - Once the shutter-release button is pressed all the way, hold the camera steady without moving it until a still picture is displayed. After taking a picture, do not turn the camera off before the monitor switches to the shooting screen.
 - The angle of view (image area) seen in the saved image will be narrower than that seen on the monitor at the time of shooting.
-  **Tripod**: Select this mode when the camera is stabilized, such as with a tripod.
 - Vibration reduction is not used even if **Vibration reduction** (111) in the setup menu is set to **On**.
 - Press the shutter-release button all the way to shoot a single picture at slow shutter speeds.
- When the shutter-release button is pressed halfway, the camera adjusts the focus to infinity. The focus area or focus indicator (12) always lights in green.

Close-up

- The focus mode (62) setting is changed to  (close range only) and the zoom is automatically set at a position where the camera can shoot from the closest possible range.
- You can move the focus area that the camera focuses on. Press the  button and then rotate the multi selector or press , , , or  to move the focus area. To adjust the following settings, press the  button to temporarily cancel focus area selection, and then adjust each setting.
 - Flash mode or self-timer
- The camera focuses on the subject even when the shutter-release button is not pressed halfway. You may hear the sound of the camera focusing.

Food

- The focus mode (📖62) setting is changed to 🍷 (macro close-up) and the zoom is automatically set at a position where the camera can shoot from the closest possible range.
- You can adjust the hue by pressing the multi selector ▲ or ▼. The hue adjustment setting is saved in the camera's memory even after the camera is turned off.
- You can move the focus area that the camera focuses on. Press the OK button and then rotate the multi selector or press ▲, ▼, ◀, or ▶ to move the focus area. To adjust the following settings, press the OK button to temporarily cancel focus area selection, and then adjust each setting.
 - Hue or self-timer
- The camera focuses on the subject even when the shutter-release button is not pressed halfway. You may hear the sound of the camera focusing.

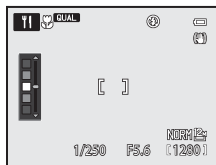

Museum

- The camera focuses at the center area of the frame.
- The camera captures up to ten images while the shutter-release button is pressed all the way, and the sharpest image in the series is automatically selected and saved (BSS (Best Shot Selector) (📖71)).

Fireworks show



- The shutter speed is fixed at 4 seconds.
- The camera focuses at infinity. When the shutter-release button is pressed halfway, the focus indicator (📖12) always lights in green.
- Zoom position from which one position toward a wide-angle position from the maximum optical zoom position cannot be used.



Black and white copy

- The camera focuses at the center area of the frame.
- When shooting nearby object, shoot with 🍷 (macro close-up) in the focus mode (📖62).













Backlighting

- On the screen that appears when  **Backlighting** is selected, HDR (high dynamic range) composition can be set.
- When **HDR** is set to **Off** (default setting): The flash fires to prevent the backlit subject from being hidden in shadow. Shoot pictures with the flash raised.
- When **HDR** is set to **Level 1**-**Level 3**: Use when taking pictures with very bright and dark areas in the same frame. Select **Level 1** when there is less difference between bright and dark areas, and **Level 3** when there is more difference between bright and dark areas.
- The camera focuses at the center area of the frame.

Notes on HDR

- Use of a tripod is recommended. Set **Vibration reduction** in the setup menu ( 110) to **Off** when using a tripod to stabilize the camera.
- The angle of view (i.e., the area visible in the frame) seen in the saved image will be narrower than that seen on the monitor at the time of shooting.
- When the shutter-released button is pressed all the way, the camera shoots pictures continuously and saves the following two images.
 - Non-HDR composite image
 - HDR composite image (loss of detail is reduced in highlights and shadows)
 - If there is only enough memory to save one image, one image processed by D-Lighting ( 93) at the time of shooting, in which dark areas of the image are corrected, is the only image saved.
- Once the shutter-release button is pressed all the way, hold the camera steady without moving it until a still picture is displayed. After taking a picture, do not turn the camera off before the monitor switches to the shooting screen.
- Depending on the shooting conditions, dark shadows may appear around bright subjects and bright areas may appear around dark subjects. You can compensate by lowering the level setting.

Panorama



- On the screen that is displayed when  **Panorama** is selected, select  **Easy panorama** or  **Panorama assist**.
- **Easy panorama** (default setting): You can take a panorama picture simply by moving the camera in the desired direction.
 - Shooting range can be selected from **Normal (180°)** (default setting) or **Wide (360°)**.
 - Press the shutter-release button all the way down, remove your finger from the button, and then slowly pan the camera horizontally. Shooting automatically ends when the camera captures the specified shooting range.
 - When shooting starts, the camera focuses on the subject at the center area of the frame.
 - The zoom is fixed at the wide-angle position.
 - When the  button is pressed while the picture recorded with Easy panorama is displayed in full-frame playback mode, the camera scrolls the displayed area automatically.
 See "Taking Pictures with Easy Panorama" (3).
- **Panorama assist**: Use this mode when shooting a series of pictures that can later be joined on a computer to form a single panorama.
 - Press the multi selector , ,  or  to select the direction in which pictures are to be joined and press the  button.
 - After shooting the first picture, shoot the necessary number of pictures while confirming the seams. To finish shooting, press the  button.
 - Transfer taken pictures to a computer and use the **Panorama Maker** software (98) to join them in a single panorama.
 See "Using Panorama Assist" (6) for more information.

Note on Printing Panorama Pictures





When printing panorama pictures, a full view may not be printed depending on the printer settings. Additionally, printing may not be available depending on the printer.

For more information, see your printer's manual or contact a digital photo lab.

Pet portrait

- When the camera is pointed at a dog or cat, it detects and focuses on its face. In the default setting, the shutter is automatically released when the camera has focused on the pet (pet portrait auto release).
- On the screen that appears when  **Pet portrait** is selected, select **Single** or **Continuous**.
 - **Single**: One picture is captured at a time
 - **Continuous**:
The camera automatically captures 3 pictures continuously at a rate of about 3 frames per second when it has focused on the detected face.
When the shutter is released manually, up to about 6 pictures are shot at a rate of about 8 frames per second while you hold the shutter-release button all the way down (when image quality is set to **Normal** and image size is set to  **4000x3000**).

Pet Portrait Auto Release

- To change **Pet portrait auto release** settings, press the multi selector .
 - : When the camera detects a pet's face, it focuses and then releases the shutter automatically.
 - **OFF**: The camera does not release the shutter automatically, even if a pet's face is detected. Press the shutter-release button to release the shutter. The camera also detects human faces (85). When both human and pet's faces are detected, the camera focuses on the pet's face.
 - In the following situations, **Pet portrait auto release** is automatically switched to **OFF**.
 - When a continuous shooting series with pet portrait auto release is repeated 5 times
 - When remaining capacity of the internal memory or memory card is low
- To continue shooting with **Pet portrait auto release**, press the multi selector  to set again.

Focus Area

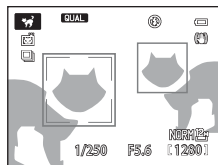

- The detected face is framed by a yellow double border (focus area). When the camera has focused on the face, the double border turns green.
- When the camera detects more than one face of dog or cat (up to 5), the largest face displayed on the monitor is framed by a double border (focus area) and the others by single borders.
- If no human or pet's faces are detected, the camera focuses on the subject at the center of the frame.



Notes on Pet Portrait

- The digital zoom is not available.
- Under some shooting conditions, such as subject-to-camera distance, speed of moving pets, direction in which the pets are facing, and brightness of the faces, the camera may be unable to detect a face, or may display a border around something other than a dog or cat.

Viewing Pictures Taken Using Pet Detection

When zooming in on an image displayed in full-frame playback mode by rotating the zoom control toward **T** () (91) (except for pictures taken with continuous shooting).

3D 3D photography

- The camera takes one picture for each eye to simulate a three-dimensional image on a 3D-compatible TV or monitor.
- After pressing the shutter-release button to shoot the first frame, move the camera horizontally to the right until the guide on the screen overlaps the subject. The camera automatically captures the second image when it detects that the subject is aligned with the guide.
- The camera focuses on the center of the first frame shot.
- The focus, exposure, and white balance are fixed when the first frame is shot, and **AE/AF-L** is displayed on the screen.
- The angle of view (the area visible in the frame) that can be stored is narrower than that which appears on the shooting screen.
- Pictures taken in this mode are saved with **Normal** as the image quality and **1920×1080** as the image size.
- The two captured images are saved as a 3D image (MPO file). The first image (the left eye image) is also saved as a JPEG file.

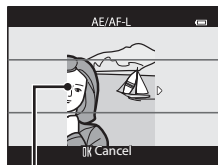

Guide

✓ Notes on 3D Photography

- Moving subjects are not suited to 3D photography.
- Pictures have a less pronounced 3D feel as the distance between the camera and background is increased.
- Pictures may have a less pronounced 3D feel when the subject is dark or when the second picture is not aligned precisely.
- Pictures taken under dim lighting may appear grainy with noise.
- The telephoto zoom position is restricted to an angle of view equivalent to that of about 135 mm lens in 35mm [135] format.
- The operation is canceled when the **OK** button is pressed after shooting the first frame or the camera cannot detect that the guide is on the subject within 10 seconds.
- If the camera does not take the second picture and cancels the shooting even when you align the guide with the subject, try shooting with the shutter-release button.

Viewing 3D Photography

- 3D images cannot be played back in 3D on the camera monitor screen. Only the left eye image is displayed during playback.
- To view 3D images in 3D, a 3D-compatible TV or monitor is required. 3D images can be played back in 3D by connecting the camera to a 3D-compatible TV or monitor using a 3D-compatible HDMI cable (📖96).
- When connecting the camera using an HDMI cable, set the following for the **TV settings** in the setup menu (📖110).
 - **HDMI: Auto** (default setting) or **1080i**
 - **HDMI 3D output: On** (default setting)
- When the camera is connected using an HDMI cable for playback, it may take a while to switch the display between 3D images and non-3D images. The images played back in 3D cannot be enlarged.
- See the documentation included with your TV or monitor to perform settings of the TV or monitor.

Note on Viewing 3D Images

When viewing 3D images on a 3D-compatible TV or monitor for an extended period of time, you may experience discomfort such as eye strain or nausea. Carefully read the documentation included with your TV or monitor to ensure proper use.

Using Skin Softening

In the following shooting modes, the camera detects up to 3 human faces when the shutter is released, and processes the image to make facial skin tones softer before saving the image.

- **Scene auto selector** (📖36), **Portrait** (📖36) or **Night portrait** (📖37) in scene mode

Skin softening can also be applied to saved images (📖93).

Notes on Skin Softening

- It may take more time to save images.
- Under some shooting conditions, the desired skin softening results may not be achieved, and skin softening may be applied to areas of the image where there are no faces.

Special Effects Mode (Applying Effects When Shooting)

The effect can be applied to pictures during shooting. One of the 10 special effects is selected to shoot.

To select an effect, press the **MENU** button to display the special effects menu.

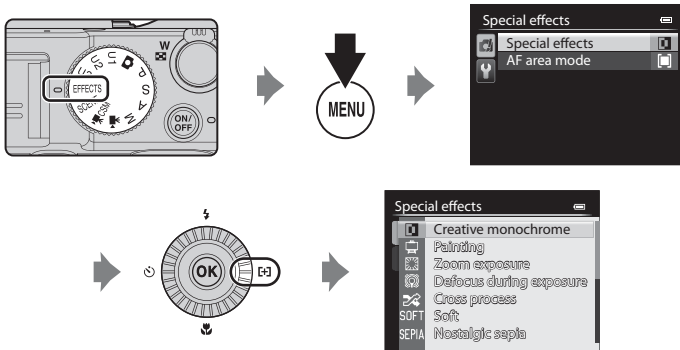

- The focus area for autofocus differs depending on the setting of **AF area mode** that can be selected in the  tab after pressing the **MENU** button.
- When **AF area mode** is set to **Auto** (default setting), the camera has 9 focus areas, and automatically selects the focus areas containing the subject closest to the camera. When the subject is in focus, the focus area (active focus area) lights in green (maximum of 9 areas).

More Information

See "Basic Menu Operations" (10) for more information.

Special Effects Mode (Applying Effects When Shooting)

Option	Description
Creative monochrome (default setting)	<p>Create monochrome photographs by adjusting the grainy feel and contrast. Monochrome photographs with the dark and light tones reversed can also be created (solarization).</p> <ul style="list-style-type: none"> • Rotate the main command dial to adjust grainy feel. • Rotate the sub-command dial to adjust contrast.
Painting	Create images with the ambience of paintings.
Zoom exposure*	<p>When the shooting mode icon lights in green, create dynamic pictures radiated out from the center by zooming from W (wide-angle position) to T (telephoto zoom position) after the shutter is open and until it is closed.</p> <ul style="list-style-type: none"> • The zoom is fixed at W (wide-angle) end. • The shutter speed is fixed at 2 seconds. • Rotate the main command dial to switch zooming magnifications (2× or 3× (default setting)). • The desired shooting effect is not produced when the subject is bright and the shutter speed cannot be slowed.
Defocus during exposure*	<p>When the shooting mode icon lights in green, create pictures by varying focus slightly until the shutter closes.</p> <ul style="list-style-type: none"> • The desired shooting effect is not produced when the subject is bright and the shutter speed cannot be slowed.
Cross process	<p>Create images with an unusual hue by converting a positive color image into negative or negative color image into positive.</p> <ul style="list-style-type: none"> • Rotate the main command dial to select hue.
Soft	Soften the image by adding a slight blur to the overall image.
Nostalgic sepia	Add a sepia tone and reduces the contrast to simulate the qualities of an old photograph.
High key	Give the overall image a bright tone.
Low key	Give the overall image a dark tone.

Option	Description
Selective color	<p>Create a black and white image in which only the specified color remains.</p> <ul style="list-style-type: none"> • Rotate the main command dial to select the color to be retained from the slider. • Press the OK button to hide the slider and cancel color selection. To display the slider again, press the OK button again. <div data-bbox="681 193 928 375" style="border: 1px solid black; padding: 5px; margin: 10px 0;"> </div> <p style="text-align: center;">Slider</p>

* Use of a tripod is recommended during **Zoom exposure** or **Defocus during exposure**. **Vibration reduction** will not function even if **Vibration reduction** in the setup menu is set to **On**.

Changing Special Effects Mode Settings

- Features That Can Be Set Using the Multi Selector → 55
- Exposure Compensation → 66
- Changing the Image Quality and Image Size → 75
- Features That Can Be Set Using the **MENU** (Menu) Button
 - AF area mode → 71
 - Setup menu → 110

P, S, A, M Modes (Setting the Exposure for Shooting)

Pictures can be shot with greater control by setting the quick menu (📖67) or shooting menu (📖70) items in addition to setting the shutter speed or aperture value manually according to shooting conditions and requirements.

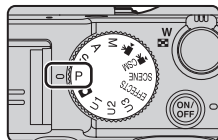

- The focus area for autofocus differs depending on the setting of **AF area mode** that can be selected in the **P, S, A** or **M** tab after pressing the **MENU** button.
- When **AF area mode** is set to **Center (normal)** (default setting), the camera will focus at the center area of the frame.

The procedure for shooting pictures at the desired brightness (exposure) by adjusting the shutter speed or aperture value is called “determine exposure”. The sense of dynamism and amount of background defocus in pictures to be shot vary depending on the combinations of shutter speed and aperture value even if the exposure is the same.

Rotate the command dial to set the shutter speed and aperture value.

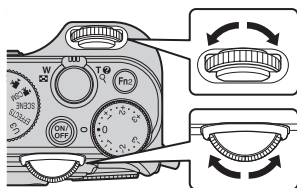

Sub-command dial

Main command dial

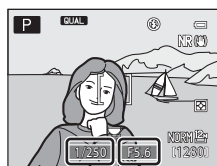

Shutter speed

Aperture value

Exposure mode	Shutter speed (📖82)	Aperture value (📖49)
P Programmed auto (📖50)	Automatically adjusted (flexible program is enabled by the main command dial).	
S Shutter-priority auto (📖50)	Adjusted by the main command dial.	Automatically adjusted.
A Aperture-priority auto (📖50)	Automatically adjusted.	Adjusted by the sub-command dial.
M Manual (📖50)	Adjusted by the main command dial.	Adjusted by the sub-command dial.

Adjusting the Shutter Speed

In **S** mode, the range is from a maximum of 1/4000 to 15 seconds.

In **M** mode, the range is from a maximum of 1/4000 to 60 seconds.

See “The Control Range of the Shutter Speed” (☞82) for more information.



Faster 1/1000 s



Slower 1/30 s

Adjusting the Aperture Value

In **A** and **M** modes, the range is from f/2 to 8 (wide-angle position) and from f/4 to 8 (telephoto zoom position).



Larger aperture (Small f-number)
f/2



Smaller aperture (Large f-number)
f/8

Aperture Value (F-number) and Zoom

Large apertures (expressed by small f-numbers) let more light into the camera, and small apertures (large f-numbers) let less light.

The aperture value of the zoom lens of this camera changes depending on the zoom position. When zooming to the wide-angle position and telephoto zoom position, the aperture values are f/2 and f/4, respectively.

- When **Fixed aperture** (☞111) is set to **On**, zooming can be performed with minimum changes in the aperture value.

Built-in ND Filter

When the subject is too bright, set **Built-in ND filter** in the shooting menu (☞71) to reduce the light and shoot.

U1, U2 or U3 (User settings) Mode

Even when the mode dial is set to **U1**, **U2** or **U3** (User settings) mode, you can shoot in **P** (Programmed auto), **S** (Shutter-priority auto), **A** (Aperture-priority auto) or **M** (Manual). The setting combinations (User settings) that are frequently used for shooting can be saved in **U1**, **U2** and **U3** (☞52).

P (Programmed auto)

Use for automatic control of the exposure by the camera.

- Different combinations of shutter speed and aperture value can be selected without changing the exposure by rotating the main command dial ("flexible program"). While flexible program is in effect, a flexible program mark (**X**) is displayed next to the mode indicator (**P**) in the upper left of the monitor screen.
- To cancel flexible program, rotate the main command dial until the flexible program mark (**X**) is no longer displayed, or press the **AE-L/AF-L** button while pressing the **Fn1** button. Selecting another shooting mode, or turning off the camera, also cancels flexible program.

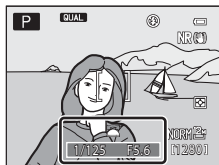

S (Shutter-priority auto)

Use to shoot fast moving subjects with a fast shutter speed, or use to emphasize the movements of a moving subject with a slow shutter speed.

- The shutter speed can be adjusted by rotating the main command dial.

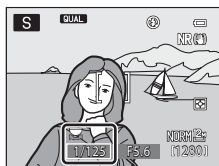

A (Aperture-priority auto)

Use to bring subjects including both the foreground and background into focus or blur the subject's background intentionally.

- The aperture value can be adjusted by rotating the sub-command dial.

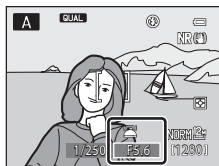

M (Manual)

Use to control the exposure according to shooting requirements.

- When adjusting the aperture value or shutter speed, the degree of deviation from the exposure value measured by the camera is displayed in the exposure indicator of the monitor screen. The degree of deviation in the exposure indicator is displayed in EVs (-3 to +3 EV in increments of 1/3 EV).
- The shutter speed can be adjusted by rotating the main command dial and the aperture value can be adjusted by rotating the sub-command dial.

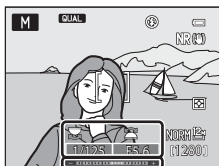

Exposure indicator

✓ Notes on Shooting

- When zooming is performed after the exposure is set, exposure combinations or aperture value may be changed.
- When the subject is too dark or too bright, it may not be possible to obtain the appropriate exposure. In such cases, the shutter speed indicator or aperture value indicator flashes when the shutter-release button is pressed halfway (except when the **M** mode is used). Change the shutter speed setting or aperture value. When settings such as **Built-in ND filter** (📖72) or **ISO sensitivity** (📖68) are changed, the appropriate exposure may be obtained.

✓ Note on ISO Sensitivity

When **ISO sensitivity** (📖68) is set to **Auto** (default setting), **ISO 80-200**, **ISO 80-400** or **ISO 80-800**, the ISO sensitivity in **M** mode is fixed at ISO 80.

✍ Control Range of the Shutter Speed

The control range differs depending on the aperture value, ISO sensitivity or continuous shooting setting. See “The Control Range of the Shutter Speed” (📖82) for more information.

✍ More Information

See “Customize command dials” (📖112) for more information.

Changing P, S, A, M Modes

- Features That Can Be Set Using the Multi Selector → 📖55
- Exposure Compensation → 📖66
- Features That Can Be Set Using the Quick Menu Dial → 📖67
- Features That Can Be Set Using the **MENU** (Menu) Button
 - Shooting menu → 📖71
 - Setup menu → 📖110

U1, U2 and U3 (User Settings Modes)

Up to three setting combinations that are frequently used for shooting (User settings) can be saved in **U1**, **U2** and **U3**. Shooting is possible in **P** (Programmed auto), **S** (Shutter-priority auto), **A** (Aperture-priority auto) or **M** (Manual).

Rotate the mode dial to **U1**, **U2** or **U3** to retrieve the settings saved in **Save user settings**.

- Frame the subject and shoot with these settings, or change the settings as required.
- The setting combinations that are retrieved when the mode dial is rotated to **U1**, **U2** or **U3** can be changed as many times as you want in **Save user settings**.

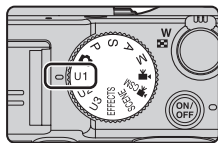

Saving Settings in U1, U2 or U3 Mode (Save User Settings)

The frequently used settings for shooting can be changed and saved in **U1**, **U2** and **U3**.

1 Rotate the mode dial to **U1**, **U2** or **U3**.

2 Change to a frequently used combination of shooting settings.

- Set the flash mode (📖56) or focus mode (📖62).
- Display the quick menu by rotating the quick menu dial (📖67).
- Press the **MENU** button to display the menu and switch between tabs with the multi selector (📖11).
 - **U1, U2, U3** tabs: Display the specialized menus for **U1**, **U2** and **U3** (📖73).
 - **P, S, A, M** tabs: Display the shooting menus (📖71).

3 After changing the settings, choose **Save user settings** in the specialized menu for **U1**, **U2** or **U3**, and press the **OK** button.

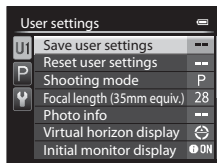

4 Choose **Yes** and press the **OK** button.

- The current settings are saved.
- Rotate the zoom control toward **T** (Q) to display the settings. Rotate toward **T** (Q) again to return to the Save user settings screen.

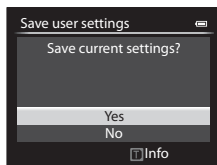

✓ Clock Battery

If the internal clock battery (🔋25) is exhausted, the settings saved in **U1, U2** or **U3** will be reset. Writing down any important setting is recommended.

📎 Confirmation Screen of User Settings

Rotate the zoom control toward **T** (Q) in step 4 of **Save user settings** to display the settings on the screen.

- 1 Shooting mode
- 2 Shutter speed (**S** or **M** mode)
- 3 Aperture value (**A** or **M** mode)
- 4 Flash mode
- 5 Flash exp. comp.
- 6 Flash control
- 7 AF area mode, Autofocus mode, AF assist
- 8 Metering, continuous shooting mode, Active D-Lighting
- 9 Noise reduction filter
- 10 Zoom memory
- 11 Focus mode, Focal length (35mm equiv.), Distortion control
- 12 Photo info, Virtual horizon display
- 13 Initial monitor display
- 14 Image quality, Image size
- 15 ISO sensitivity
- 16 White balance
- 17 Auto bracketing
- 18 Picture Control

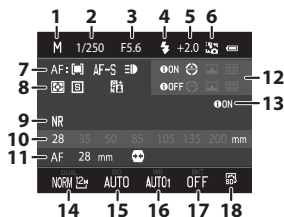

Changing U1, U2 or U3 Mode Settings

- Features That Can Be Set Using the Multi Selector → 55
- Exposure Compensation → 66
- Features That Can Be Set Using the Quick Menu Dial → 67
- Features That Can Be Set Using the **MENU** (Menu) Button
 - Shooting menu → 71
 - Specialized menu for **U1, U2** or **U3** → 73
 - Setup menu → 110

Resetting for U1, U2 and U3

If **Reset user settings** is selected in specialized menu for **U1, U2** or **U3**, the settings that are saved in the user settings are reset as follows:

- Specialized menus for **U1, U2** and **U3**: **Shooting mode: P Programmed auto, Focal length (35mm equiv.): 28 mm, Photo info:** information hidden, **Virtual horizon display: Circle, Initial monitor display: Show info, Flash mode: ~~AUTO~~ Auto, Focus: AF Autofocus, Self-timer: Off, AF assist: Auto**
- Shooting menu, quick menu: Same as the default setting for each item.

Features That Can Be Set Using the Multi Selector

Press the multi selector **▲** (⚡), **◀** (😊), **▼** (👤), or **▶** (⊕) while shooting to operate the following functions.

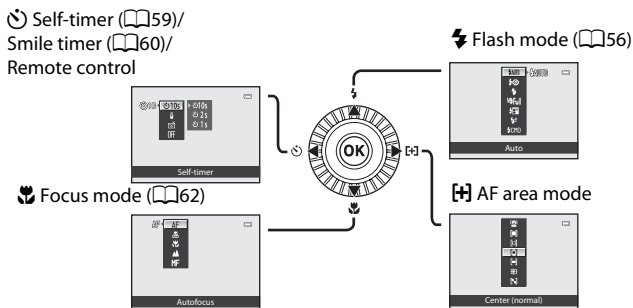

Available Functions

Available functions differ according to the shooting mode as follows.

- See “List of the Default Settings” (📖64) for more information on the default settings in each shooting mode.

Function	📷	SCENE	EFFECTS	P, S, A, M, U1, U2, U3	📡, CSM
⚡ Flash mode (📖56)	✓	3	3	✓	–
🕒 Self-timer (📖59)	✓			✓	✓
😊 Smile timer (📖60)	✓			✓	–
🔑 Remote control ¹	✓			✓	✓
👤 Focus mode (📖62)	✓			✓	✓
⊕ AF area mode ²	–	–	–	✓	–

¹ Use the Remote Control ML-L3 (available separately) to release the shutter (📷104).

² Set the method of how to change the focus area for autofocus (📖71). Set **Multi selector right press** to **Off** in the setup menu (📖110) if you do not want to display the selected focus area when the multi sector **▶** is pressed.

³ The setting varies with scene mode or special effects. See “List of the Default Settings” (📖64) for more information.

Using the Flash (Flash Modes)

You can shoot pictures with a flash by raising the built-in flash. You can set a flash mode that suits the shooting conditions.

1 Lower the ⚡ (flash pop-up) control to raise the flash.

- When the flash is lowered, the flash mode is fixed at ⚡ (off).

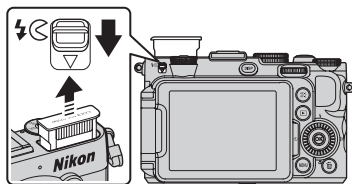

2 Press ▲ (⚡ flash mode) on the multi selector.

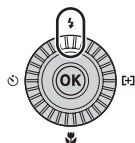

3 Press the multi selector to select the desired mode and press the OK button.

- See “Available Flash Modes” (p.57) for more information.
- When the manual flash is selected, select the flash output and press the OK button.
- If the OK button is not pressed within a few seconds, the selection will be canceled.
- When ⚡AUTO (auto) is applied, ⚡AUTO is only displayed for a few seconds even if monitor indicators (p.9) are turned on.

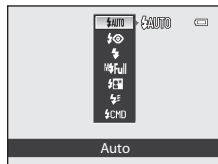









4 Frame the subject and shoot.

- When you press the shutter-release button halfway, you can check the current flash mode by the icon at the top of the monitor.
 - On: When the shutter-release button is pressed all the way, the flash will fire in accordance with the flash mode set. When ⚡AUTO (auto) is set, the flash will fire if ⚡ is displayed.
 - Flashing: The flash is charging. The camera cannot take pictures.
 - Off: The flash will not fire when a picture is taken.



Available Flash Modes

	AUTO Auto
	Flash fires automatically when lighting is dim.
	Auto with red-eye reduction
	Best choice for portraits. Reduces red-eye effect caused by flash in portraits (📖58).
	Off
	Flash does not fire. <ul style="list-style-type: none"> Available when an external flash unit (optional) is attached.
	Fill flash
	The flash fires when a picture is taken, regardless of how bright the subject is. Use to “fill-in” (illuminate) shadows and backlit subjects.
	Manual
	Flash is forcibly fired at the flash output that is set for the built-in flash or optional Speedlight SB-400. <ul style="list-style-type: none"> Choose the flash output from M Full (full flash), M 1/2, M 1/4, M 1/8, M 1/16, M 1/32, M 1/64 and M 1/128 (SB-400 only). For example, when M 1/16 is chosen, the flash is 1/16 of the full flash.
	Slow sync
	Fill flash is combined with a slow shutter speed. Suitable for portraits of human subjects shot at night or under dim light. Flash illuminates main subject; slow shutter speeds are used to capture background.
	Rear-curtain sync
	Fill flash fires just before the shutter closes, creating the effect of a stream of light behind moving subjects.
	Commander mode
	The camera's built-in flash emits low-level flashes and an off-camera optional flash unit is controlled wirelessly as a remote flash (🔗57). The Speedlight fires according to the Commander mode options set in the shooting menu (📖70). <ul style="list-style-type: none"> Not available when an optional flash unit is attached. Can be used when P, S, A, M, U1, U2 or U3 mode is selected.

Features That Can Be Set Using the Multi Selector

✔ High Temperature Caution

If you are taking pictures repeatedly with the flash within a short period of time, the flash unit and its surrounding area can become hot. Before lowering the flash, be sure to allow the flash unit and its surrounding area to cool down.

✎ Lowering the Flash

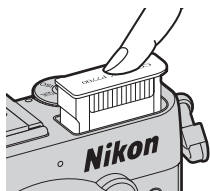

When not using the flash, gently push to lower the flash until it clicks shut.



✎ Effective Range of the Built-in Flash

The built-in flash has a range of about 0.5 to 10 m (1 ft 8 in. to 32 ft) for wide-angle position, and about 0.5 to 5.5 m (1 ft 8 in. to 18 ft) for telephoto zoom position (when **ISO sensitivity** is set to **Auto**).

✎ Flash Mode Setting

- The setting varies with shooting mode. See “Available Functions” (📖55) and “List of the Default Settings” (📖64) for more information.
- Some features cannot be used in combination with other menu settings. See “Features Not Available in Combination” (📖79) for more information.
- The changed flash mode setting applied in the following situations is saved in the camera's memory even after the camera is turned off.
 - When shooting mode **P**, **S**, **A** or **M** is used
 - When  (auto with red-eye reduction) is selected in  (auto) mode

✎ Auto with Red-eye Reduction

This camera uses **advanced red-eye reduction (“In-Camera Red-Eye Fix”)**.

If the camera detects “red-eye” when a picture is taken, Nikon's own In-Camera Red-Eye Fix processes the image before it is recorded.

Note the following when taking pictures:

- The time required to save the picture increases slightly.
- Advanced red-eye reduction may not produce the desired results in some situations.
- In extremely rare instances, areas not subject to red-eye may be affected by advanced red-eye reduction processing. In these cases, choose another mode and try again.

✎ External Flash Unit

You can attach the Nikon Speedlights to the camera's accessory shoe (📖1) to take pictures. See “Speedlights (External Flash Unit)” (📖87) for more information.

Using the Self-timer

The self-timer is suitable for taking group shots including yourself and reducing the vibration when the shutter-release button is pressed.

When using the self-timer, use of a tripod is recommended. Set **Vibration reduction** in the setup menu (📖110) to **Off** when using a tripod to stabilize the camera.

- 1 Press ◀ (🕒 self-timer) on the multi selector.

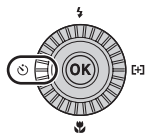

- 2 Use the multi selector to select 🕒10s (or 🕒2s, 🕒1s) and press the OK button.

- To change the time for self-timer, press ▶ before pressing the OK button.
- 🕒10s (10 seconds): suitable for group pictures.
- 🕒2s (2 seconds), 🕒1s (1 second): suitable for preventing camera shake.
- When the shooting mode is set to **Pet portrait** in scene mode, 🐾 (pet portrait auto release) is displayed (📖42). The self-timer is not available.
- The mode selected for the self-timer is displayed.
- If the OK button is not pressed within a few seconds, the selection will be canceled.

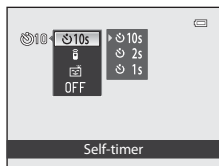

- 3 Frame the picture and press the shutter-release button halfway.

- Set the focus and exposure.

- 4 Press the shutter-release button all the way.

- The self-timer starts, and the number of seconds remaining before the shutter is released is displayed. The self-timer lamp flashes while the timer is counting down. About one second before the shutter is released, the lamp stops flashing and remains lit (except 🕒1s).
- When the shutter is released, the self-timer turns **OFF**.
- To stop the timer before a picture is taken, press the shutter-release button again.

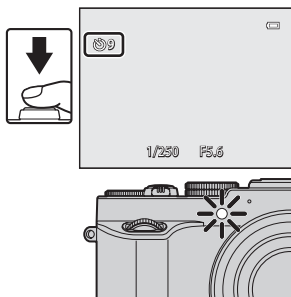

More Information

See “Self-timer: after release” (📖110) for more information.

Shooting Smiling Faces Automatically (Smile Timer)

When this mode is selected, the camera detects smiling faces and automatically releases the shutter even if you do not press the shutter-release button.

- This function can be used when the shooting mode is (auto), **P**, **S**, **A**, **M**, **U1**, **U2**, **U3**, scene mode **Portrait** or **Night portrait**.

1 Press (self-timer) on the multi selector.

- Change any flash mode, exposure, or shooting menu settings before pressing the button.

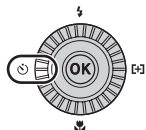

2 Use the multi selector to choose (Smile timer), and press the button.

- If the button is not pressed within a few seconds, the selection will be canceled.

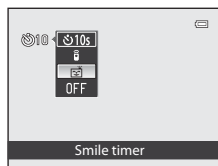

3 Frame the picture and wait for the subject to smile without pressing the shutter-release button.

- When the camera detects a face, a yellow double border (focus area) is displayed around that face. When the camera focuses on that face, the double border will turn green for a moment and focus is locked.
- Up to 3 faces are detected. When more than one face is detected, the face closest to the center of the frame is framed by a double border and the others by single borders.
- If the camera detects that the face framed by the double border is smiling, the shutter is automatically released.
- Each time the shutter is released, automatic shooting using face detection and smile detection is repeated.

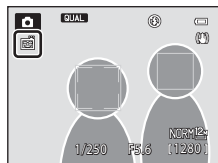

4 Finish shooting.

- To cancel smile detection and finish shooting, return to step 1 and select **OFF**.

Notes on Smile Timer

- The digital zoom is not available.
- Under some shooting conditions, faces and smiling faces may not be detected properly.
- See “Using Face Detection” (📖85) for more information.
- The smile timer cannot be used simultaneously with certain shooting modes. See “Available Functions” (📖55) and “List of the Default Settings” (📖64) for more information.
- Some features cannot be used in combination with other menu settings. See “Features Not Available in Combination” (📖79) for more information.

When the Self-timer Lamp Flashes

When the camera detects a face, the self-timer lamp flashes. The lamp quickly flashes immediately after the shutter is released.

Releasing the Shutter Manually

The shutter can also be released by pressing the shutter-release button. If no faces are detected, the camera focuses on the subject at the center area of the frame.

More Information

See “Autofocus” (📖86) for more information.



Available Focus Modes

AF Autofocus

The camera automatically adjusts the focus according to the distance to the subject. Use when the distance from the subject to the lens is 50 cm (1 ft 8 in.) or more, or 80 cm (2 ft 8 in.) or more at the maximum telephoto zoom position.

Close range only/ Macro close-up

Use for close-ups of flowers or small objects.

How close you can be to the subject while shooting depends on the zoom position. When the zoom ratio is set to a position where / and the zoom indicator light in green, the camera can focus on subjects at approx. 10 cm (4 in.) or farther from the lens. At the maximum wide-angle zoom position (zoom position ) , the camera can focus on subjects at approx. 2 cm (0.8 in.) or farther from the lens.

- When using the maximum telephoto zoom position, the camera can focus on subjects at approx. 45 cm (1 ft 6 in.) or farther from the lens.
- When using  (close range only), the camera focuses on subjects in close range. The camera may not be able to focus on subjects at far distances.

Infinity

Use when shooting distant scenes through window glass or when shooting landscapes. The camera automatically adjusts the focus near infinity.

- The camera may not be able to focus on nearby objects.
- The flash mode is set to  (off).

MF Manual focus



The focus can be adjusted for any subject that is a distance of 2 cm (0.8 in.) to infinity from the lens (2). The closest distance at which the camera can focus varies depending on the zoom position.

- This function can be used when the shooting mode is **P**, **S**, **A**, **M**, **U1**, **U2**, **U3**, special effects mode, **Sports** scene mode, movie mode or movie custom setting mode.



Note on Shooting with the Flash

The flash may be unable to light the entire subject at distances of less than 50 cm (1 ft 8 in.).

Focus Mode Setting

- The setting varies with the shooting mode. See “Available Functions” (55) and “List of the Default Settings” (64) for more information.
- Some features cannot be used in combination with other menu settings. See “Features Not Available in Combination” (79) for more information.
- For shooting modes **P**, **S**, **A** and **M**, the changed focus mode setting is saved in the camera’s memory even after the camera is turned off.

Macro Close-up

In shooting modes such as scene modes that cannot use the **Autofocus mode** (71), **Full-time AF** may be turned on and the camera will adjust focus even if the shutter-release button is not pressed halfway when  (close range only) or  (macro close-up) is set. You may hear a sound of the camera focusing.

List of the Default Settings

The default settings in each shooting mode are described below.

- Similar information about scene mode can be found on the next page.

Shooting mode	Flash mode ¹ (☰56)	Self-timer (☰59)	Focus mode (☰62)	AF area mode (☰71)
📷 (auto) (☰34)	🔦AUTO	OFF ²	AF ³	–
EFFECTS (special effects) (☰45)	🔦 ⁴	OFF	AF	📷 ⁵
P, S, A, M (☰48)	🔦AUTO	OFF ²	AF	📷
U1, U2, U3 (User settings) (☰52)	🔦AUTO	OFF ²	AF	📷
🎬 (movie), 🎬CSM (movie custom setting) (☰101)	🔦 ⁶	OFF	AF	–

¹ When the flash is lowered, the flash mode is fixed at 🔦 (off).

² Smile timer can also be selected.

³ MF (manual focus) cannot be selected.

⁴ The flash is fixed at 🔦 (off) when **Zoom exposure** or **Defocus during exposure** is selected.

⁵ 📷 (subject tracking) and 📷 (target finding AF) are not available.

The AF area mode is fixed at **Center (normal)**, when **Zoom exposure** is selected.









































































⁶ The setting cannot be changed.

- The setting applied in shooting modes **P, S, A** and **M** is saved in the camera's memory even after the camera is turned off (except for self-timer).

📌 Features Not Available in Combination

Some features cannot be used in combination with other menu settings (☰79).

Default settings in scene mode are described below.

	Flash mode ¹ ( 56)	Self-timer ( 59)	Focus mode ( 62)	AF area mode ( 71)
 ( 36)	 AUTO ²	OFF	AF ³	–
 ( 36)		OFF ⁴	AF ³	–
 ( 37)	 ³	OFF	 ³	–
 ( 37)	 ³	OFF ⁵	AF ⁶	–
 ( 37)		OFF ⁴	AF ³	–
 ( 37)		OFF	AF ³	–
 ( 37)	 AUTO	OFF	AF ⁹	–
 ( 37)	 AUTO	OFF	AF ⁹	–
 ( 37)	 ³	OFF	 ³	–
 ( 38)	 ³	OFF	 ³	–
 ( 38)	 ³	OFF	 ³	–
 ( 38)	 ³	OFF	 ³	–
 ( 39)	 ³	OFF	 ³	–
 ( 39)	 ³	OFF ¹⁰	AF ⁹	–
 ( 39)	 ³	OFF	 ³	–
 ( 39)	 ³	OFF	AF ⁹	–
 ( 40)	 /  ¹¹	OFF	AF ³	–
 ( 41)	 ¹²	OFF	AF ⁹	–
 ( 42)	 ³	 ¹³	AF ⁹	–
3D ( 43)	 ³	OFF ³	AF ⁹	–

¹ When the flash is lowered, the flash mode is fixed at  (off).

² The camera automatically selects the flash mode appropriate for the scene it has selected. The setting cannot be changed when using the built-in flash.

³ The setting cannot be changed.

⁴ Smile timer can also be selected.

⁵ When the shutter is released using self-timer or remote control, continuous shooting cannot be performed.

⁶ AF (autofocus) or MF (manual focus) can be selected.

⁷ The setting cannot be changed. The flash mode setting is fixed at fill flash with slow sync and red-eye reduction.

⁸ May switch to slow sync with red-eye reduction flash mode.

⁹ AF (autofocus) or  (macro close-up) can be selected.

¹⁰ When the shutter is released using self-timer or remote control, BSS (Best Shot Selector) is disabled.

¹¹ When HDR is set to Off, the flash mode is fixed at  (fill flash). When HDR is set to other than Off, the flash mode is fixed at  (off).

¹² The setting cannot be changed when using Easy panorama.

¹³ Pet portrait auto release (42) can be set to on or off. Self-timer and remote control cannot be used.

Features That Can Be Set Using the Exposure Compensation Dial

Adjusting Brightness (Exposure Compensation)

When the exposure compensation is set for shooting, the brightness of the overall image can be adjusted to make it brighter or darker.

Select the compensation value by rotating the exposure compensation dial.

Setting	Explanation
"+" side	Make the subject brighter than the exposure set by the camera.
"-" side	Make the subject darker than the exposure set by the camera.
"0"	Cancel the exposure compensation.

- When set to a value other than "0", the  mark and compensation value are displayed on the monitor screen and the exposure compensation dial mark turns on when shooting.

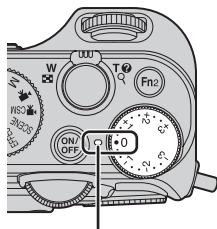

Exposure compensation dial mark

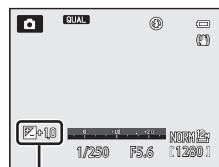

Exposure compensation value

Exposure Compensation Value

- If the exposure compensation value is set to a value other than 0.0 when the shooting mode is **M** (manual) mode, the exposure is not compensated and the standard value of exposure indicator will change.
- When the shooting mode is **Fireworks show** scene mode ()39), exposure compensation cannot be used.
- When the exposure compensation is set while using a flash, the compensation is applied to both the background exposure and to the flash output.

Exposure Compensation During Movie Recording

- The range of exposure compensation values that can be set is between -2 and +2.
- Once movie recording starts, the compensation value is not adjusted even when the exposure compensation dial is rotated.
- If the exposure compensation value is set to a value other than 0.0 when **Shooting mode** ()108) of the movie custom setting is **Manual**, the exposure is not compensated and the standard value of the exposure indicator will not change either.

Features That Can Be Set Using the Quick Menu Dial (Shooting Mode)

When the quick menu dial is rotated while shooting, the quick menu is displayed for the function that is selected with the mark. When the quick menu is displayed, the quick menu dial mark turns on.

See “Using the Quick Menu” (📖69) for more information.

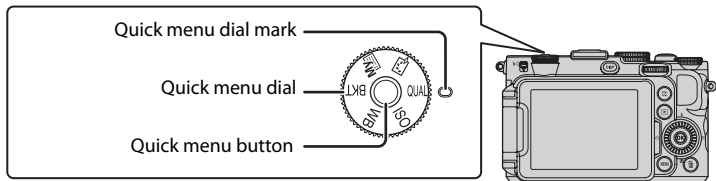













Available functions differ according to the shooting mode.

Dial position	Function		P, S, A, M, U1, U2, U3	SCENE	EFFECTS
QUAL	Image quality/Image size (📖68)	✓	✓	✓	✓
ISO	ISO sensitivity (📖68)	-	✓	-	-
WB	White balance (📖68)	-	✓	-	-
BKT	Auto bracketing (📖68)	-	✓	-	-
	My Menu (📖68)	-	✓	-	-
	Picture Control (📖68)	-	✓	-	-

Features Not Available in Combination

Some features cannot be used in combination with other menu settings (📖79).

Available Quick Menu

Option	Description	
QUAL Image quality/ Image size	Set the image quality (compression ratio) and image size to be recorded ( 75). The default setting of image quality is Normal , and of image size is  4000x3000 .	75
ISO ISO sensitivity	Higher ISO sensitivity allows you to take pictures of darker subjects. Additionally, even with subjects of similar brightness, pictures can be taken at faster shutter speeds, and blurring caused by camera shake and subject movement can be reduced. When ISO sensitivity is set to Auto (default setting), the camera sets the ISO sensitivity automatically. <ul style="list-style-type: none"> In M (manual) mode, when set to Auto, ISO 80-200, ISO 80-400 or ISO 80-800, the ISO sensitivity is fixed at ISO 80. 	 31
WB White balance	Adjust colors in the image closer to the colors as they appear to the eye. Although Auto (normal) (default setting) can be used under most types of lighting, you can apply the white balance setting suited to the sky conditions or light source to achieve better results if the default setting results are unsatisfactory. <ul style="list-style-type: none"> To adjust white balance using color temperature () , select  Choose color temp. of White balance in the first line, and then select the value in Choose color temp. in the second line. The preset value for preset manual applies commonly to P, S, A, M, U1, U2 and U3 shooting modes, and movie mode. 	 33
BKT Auto bracketing	Continuous shooting can be performed while changing the exposure (brightness) automatically with the shutter speed (Tv), aperture value (Av) or ISO sensitivity (Sv), or multiple images can be recorded while varying the white balance (WB). The default setting is OFF .	 36
 My Menu	Display only the menu items that are frequently used for shooting. <ul style="list-style-type: none"> Options that are displayed in My Menu can be changed from Customize My Menu in the setup menu (110). 	 86
 Picture Control	Change the settings for image recording according to the shooting scene or your preferences. The default setting is Standard .	 38

Using the Quick Menu

1 Rotate the quick menu dial to select a quick menu.

- Quick menu can also be displayed by pressing the quick menu button.

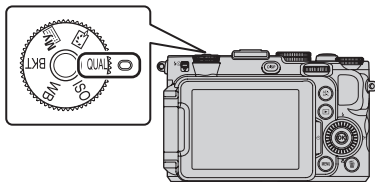

2 Use the multi selector to select a menu item.

- Press ◀ or ▶ to change the setting value. The value can also be changed by rotating the main command dial.
- When there are multiple setting items, press ▲ or ▼ to select.

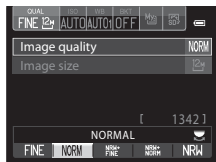

3 After completing the settings, press the quick menu button or the OK button.

- The monitor display reverts to shooting screen.

Features That Can Be Set Using the MENU (Menu) Button (Shooting Mode)

The shooting menu can be set by pressing the **MENU** button in shooting mode.

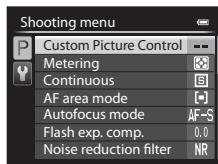
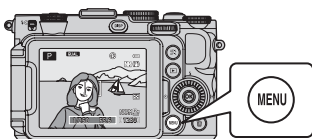

Available functions differ according to the shooting mode.

Function		P, S, A, M, U1, U2, U3 ¹	SCENE ²	EFFECTS ³
Custom Picture Control (📖71)	-	✓	-	-
Metering (📖71)	-	✓	-	-
Continuous (📖71)	-	✓	-	-
AF area mode (📖71)	-	✓	-	✓ ⁴
Autofocus mode (📖71)	-	✓	-	-
Flash exp. comp. (📖71)	-	✓	-	-
Noise reduction filter (📖71)	-	✓	-	-
Built-in ND filter (📖72)	-	✓	-	-
Distortion control (📖72)	-	✓	-	-
Active D-Lighting (📖72)	-	✓	-	-
Zoom memory (📖72)	-	✓	-	-
Startup zoom position (📖72)	-	✓	-	-
M exposure preview (📖72)	-	✓	-	-
Focus-coupled metering (📖72)	-	✓	-	-
Commander mode (📖72)	-	✓	-	-

¹ In **U1, U2** or **U3** mode, the specialized menu for **U1, U2** or **U3** is displayed in the top tab and the shooting menu is displayed in the second tab from the top. See 📖73 for more information on specialized menu for **U1, U2** or **U3**.

² The type of scene can be selected. See 📖35 for more information.

³ The type of effects can be selected in **Special effects** mode. See 📖45 for more information.

⁴ **Subject tracking** and **Target finding AF** are not available.













Features Not Available in Combination

Some features cannot be used in combination with other menu settings (📖79).

More Information

See "Basic Menu Operations" (📖10) for more information.

Options Available in the Shooting Menu

Option	Description	
Custom Picture Control (COOLPIX Custom Picture Control)	Allow you to store the customized settings based in COOLPIX Picture Control, which can set picture editing options for recording images according to the shooting scene or your preferences.	 42
Metering	Select the method that the camera uses to measure the brightness of the subject. The camera adjusts the exposure, which is a combination of shutter speed and aperture value, based on the brightness measurement. The default setting is Matrix .	 43
Continuous	Set the mode used for taking a series of pictures. <ul style="list-style-type: none"> The default setting is Single (i.e. only one picture is captured at a time). When Continuous H, Continuous M, Continuous L, or BSS (39) is set, the pictures are shot continuously while the shutter-release button is fully held down. If Continuous H: 120 fps, Continuous H: 60 fps, or Multi-shot 16 is set, the specified number of pictures are shot continuously when the shutter-release button is fully held down. If the Intvl timer shooting is set, the pictures are shot continuously at the set interval of 30 s, 1 min, 5 min, or 10 min when the shutter-release button is fully held down once. 	 44
AF area mode	Set how the camera determines the focus area using the autofocus to Face priority ( 85), Auto , Manual , Center (normal) , Center (wide) , Subject tracking or Target finding AF ( 84). <ul style="list-style-type: none"> The AF area mode can also be selected by pressing the multi selector  (+). 	 47
Autofocus mode	When Single AF (default setting) is selected, the camera focuses only while the shutter-release button is pressed halfway. When Full-time AF is selected, the camera focuses even when the shutter-release button is not pressed halfway. You may hear the sound of the camera focusing.	 51
Flash exp. comp.	Adjust the flash output. Use this option when the flash is too bright or too dark. The default setting is 0.0 .	 51
Noise reduction filter	Set the strength of the noise reduction function that is normally performed when recording the picture. The default setting is Normal .	 52

Features That Can Be Set Using the MENU (Menu) Button (Shooting Mode)

Option	Description	
Built-in ND filter	Select On or Off (default setting) for the built-in ND filter. Set this feature to On in conditions such as too bright overexposure results from the subject, so that the amount of light that enters the camera is reduced.	 52
Distortion control	Select whether to correct the peripheral distortion that occurs due to the intrinsic characteristics of lenses. Enabling distortion control reduces the size of the frame, as compared to when distortion control is not enabled. The default setting is Off .	 53
Active D-Lighting	Prevent loss of contrast details in highlights and shadows when shooting images. The default setting is Off .	 53
Zoom memory	When the zoom control is operated while pressing the Fn1 button, the camera changes in steps to the focal length (equivalent to 35mm [135] format of angle of view) of the zoom lens that is set in advance. <ul style="list-style-type: none"> The default setting is on  for all the check boxes. 	 54
Startup zoom position	When the camera is turned on, the zoom position moves to the focal length (equivalent to 35mm [135] format of angle of view) of the zoom lens that is set in advance. The default setting is 28 mm .	 54
M exposure preview	When On is selected, the exposure setting resulting from the shutter speed and aperture value set in M (manual) mode is reflected in the brightness on the shooting screen. The default setting is Off .	 55
Focus-coupled metering	When On (default setting) is selected and if Metering ( 71) is set to Matrix or Spot and AF area mode ( 71) is set to Manual , the brightness of the subject is measured by giving higher priority to the focus area.	 55
Commander mode	Set how the optional flash unit fires when the flash mode ( 57) is set to  CMD (commander mode). The default setting for Flash mode is Standard flash and that for Flash control mode is TTL .	 56

Available Specialized Menu for U1, U2 or U3

In **U1**, **U2** or **U3** mode, the following settings for the specialized menu can be changed, as well as the shooting menu.

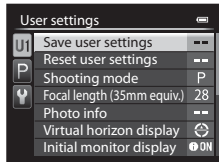

Set to **U1**, **U2** or **U3** mode → **MENU** button → **U1**, **U2** or **U3** tab

Option	Description	
Save user settings	The current settings are stored.	52
Reset user settings	The settings saved to U1 , U2 or U3 are reset.	54
Shooting mode	Choose the standard shooting mode (default setting is P). The current flexible program (when set to P), shutter speed (when set to S or M) or aperture value (when set to A or M) settings are also saved.	27
Focal length (35mm equiv.)	Set the zoom position for when the mode dial is set. Select 28 mm (default setting), 35 mm , 50 mm , 85 mm , 105 mm , 135 mm , 200 mm , Current zoom position or Not stored .	-
Photo info	Set whether or not the virtual horizon, histogram and framing grid are displayed on the monitor screen when the mode dial is set. This setting is not applied to the setup menu settings.	110
Virtual horizon display	Set the virtual horizon display for when the mode dial is set. This setting is not applied to the setup menu settings.	110
Initial monitor display	Set the information displayed on the monitor screen when the mode dial is set (default setting is Show info).	9
Flash mode	Set the flash mode for when the mode dial is set.	56
Focus	Set the focus mode for when the mode dial is set. The current focus distance is also saved when the focus mode is MF (manual focus).	62

Features That Can Be Set Using the MENU (Menu) Button (Shooting Mode)

Option	Description	
Self-timer	Set the self-timer when the mode dial is set.	59
AF assist	Enable or disable the AF assist mode for when the mode dial is set. This setting is not applied to the setup menu settings.	111

Changing the Image Quality and Image Size

Display the shooting screen → QUAL (Quick menu dial) (📖69) → Image quality/Image size

The image quality (compression ratio) and image size can be selected for recording.

- When the mode dial is rotated to 🎬 (movie) mode or 🎬CSM (movie custom setting) mode, **Movie options** can be set (📖106).

Available Image Quality

Lower compression ratios result in higher quality pictures, but also larger file sizes, limiting the number of pictures that can be recorded.

Option		Description
FINE	Fine	Fine image quality than Normal , suitable for enlargement or high quality prints. File format: JPEG, compression ratio of about 1:4
NORM	Normal (default setting)	Normal image quality, suitable for most applications. File format: JPEG, compression ratio of about 1:8
NRW+ FINE	NRW (RAW) + Fine*	Two images are recorded at the same time: one NRW (RAW) image and one fine-quality JPEG image.
NRW+ NORM	NRW (RAW) + Normal*	Two images are recorded at the same time: one NRW (RAW) image and one normal-quality JPEG image.
NRW	NRW (RAW)*	Raw data from the image sensor are saved. Create JPEG image files after shooting using NRW (RAW) processing in the playback menu (📖93). <ul style="list-style-type: none">• When NRW (RAW) is selected, Image size is reset to 📏 4000×3000. File format: NRW (RAW)

* NRW (RAW) images cannot be selected in scene mode or special effects mode (except for **Zoom exposure** and **Defocus during exposure**).

COOLPIX P7700 NRW (RAW) Images

- The extension of the picture taken is “.NRW.”
- NRW (RAW) images cannot be printed. Creating JPEG images with **NRW (RAW) processing** enables the images to be printed using PictBridge compatible printers or in digital photo labs.
- No editing other than NRW (RAW) processing can be performed for images in the NRW (RAW) format. To edit such images, first create JPEG images using **NRW (RAW) processing** (📖94), and then edit the JPEG images.
- ViewNX 2 needs to be installed on the computer to be able to view NRW (RAW) images on the computer. Capture NX 2 is also compatible with NRW (RAW) images.
- Install ViewNX 2 on a computer using the included ViewNX 2 CD-ROM (See “Using ViewNX 2” (📖97).)
For more information on using ViewNX 2, refer to the on-screen instructions and help information contained in ViewNX 2.

Image Quality Setting

- The setting for image quality is shown by an icon displayed on the monitor during shooting and playback (📖12 to 15).
- The setting is also applied to other shooting modes (except for shooting modes **U1**, **U2** and **U3**).
- NRW (RAW) images cannot be recorded in the following shooting modes.
 - Scene mode
 - Special effect mode (except for **Zoom exposure** and **Defocus during exposure**)When the mode is changed to scene mode or special effect mode (except for **Zoom exposure** and **Defocus during exposure**) from other shooting modes, the image quality is changed according to situation as follows.
 - When **NRW (RAW)** is set, the image quality is changed to **Normal**.
 - When **NRW (RAW) + Fine** or **NRW (RAW) + Normal** is set, the image quality is changed to **Fine** or **Normal** respectively.
- The digital zoom cannot be used when **Image quality** is set to **NRW (RAW)**, **NRW (RAW) + Fine** or **NRW (RAW) + Normal**.
- Some features cannot be used in combination with other menu settings. See “Features Not Available in Combination” (📖79) for more information.

Recording of NRW (RAW) and JPEG Images at the Same Time

- The NRW (RAW) image and the JPEG image that are recorded at the same time have the same file number but with their own file extensions, “.NRW” and “.JPG” (📖100).
- When playing back on the camera, only the JPEG image is displayed.
- Note that when the JPEG image is deleted by pressing the  button, the NRW (RAW) image that was recorded at the same time is also deleted.

More Information











- See “Number of Exposures Remaining” (📖78) for more information.
- See “File and Folder Names” (📖100) for more information.

Available Image Size

You can set the JPEG image size (amount of pixels) for pictures recorded with an image quality of **Fine** or **Normal**.

The larger the image, the larger the size at which it can be printed or displayed without becoming noticeably “grainy,” limiting the number of pictures that can be recorded.

Conversely, small image sizes are suitable for pictures attached to e-mails or used on web pages. However, printing small images in large print sizes results in the image turning “grainy.”

Options*	Description
 4000×3000 (default setting)	Record pictures with finer detail than those shot at  3264×2448 .
 3264×2448	Good balance between file size and quality; suitable in most situations.
 2272×1704	
 1600×1200	Smaller than  2272×1704 ; for recording more pictures.
 640×480	Record pictures suitable for display on a television with a screen aspect ratio of 4:3, or for e-mail attachment.
 3984×2656	Record pictures with the same aspect ratio (3:2) as those shot with 35mm [135] format film cameras.
 3968×2232	Record pictures with the same aspect ratio (16:9) as wide screen TV.
 3000×3000	Record square pictures.

* The total number of pixels captured, and the number of pixels captured horizontally and vertically.







Example:  **4000×3000** = 12 megapixels, 4000 × 3000 pixels

Image Size Setting

- The setting for the image size is shown by an icon displayed on the monitor during shooting and playback ( 12 to 15).
- The setting is also applied to other shooting modes (except for shooting modes **U1**, **U2** and **U3**).
- The size of JPEG images can be chosen when you create JPEG images from NRW (RAW) images using **NRW (RAW) processing** ( 94) (up to a maximum of 4000 × 3000 pixels).
- **Image size** for the JPEG image can be set when **NRW (RAW) + Fine** or **NRW (RAW) + Normal** is selected. However, note that  **3984×2656**,  **3968×2232** and  **3000×3000** cannot be selected.
- Some features cannot be used in combination with other menu settings. See “Features Not Available in Combination” ( 79) for more information.

Number of Exposures Remaining

The following table lists the approximate number of pictures that can be stored on a 4 GB memory card, at each combination of **Image size** (📷77) and **Image quality** (📷75) settings. Note that the number of exposures that can be stored differs depending on the composition of the image (due to JPEG compression). In addition, this number may differ depending on the make of memory card, even if the capacity of the memory card is the same.

After removing the memory card, check the indicator showing the number of exposures that can be stored in the internal memory (approx. 86 MB) on the screen during shooting.

Image size	Image quality	Memory card ¹ (4 GB)	Print size ² (cm/in.)
📷 4000×3000 (default setting)	Fine Normal NRW (RAW)	620 1,110 140	34 × 25/13 × 10
📷 3264×2448	Fine Normal	930 1,650	28 × 21/11 × 8
📷 2272×1704	Fine Normal	1,880 3,550	19 × 14/7.5 × 5.6
📷 1600×1200	Fine Normal	3,650 6,350	13 × 10/5.3 × 4
📷 640×480	Fine Normal	20,100 30,100	5 × 4/2 × 1.5
📷 3984×2656	Fine Normal	700 1,270	34 × 22/13 × 8.8
📷 3968×2232	Fine Normal	840 1,500	33 × 19/13 × 7.4
📷 3000×3000	Fine Normal	830 1,470	25 × 25/10 × 10

1 If the number of exposures remaining is 10,000 or more, "9999" is displayed.

2 The print size at an output resolution of 300 dpi.

Print sizes are calculated by dividing the number of pixels by the printer resolution (dpi) and multiplying by 2.54 cm (1 in.). However, even with the same image size setting, images printed at higher resolutions print smaller than the size indicated, and those printed at lower resolutions print larger than the size indicated.

3 The print size of NRW (RAW) images differs according to the image size of the NRW (RAW) processed images (📷94).

📄 Printing Images of Size 1:1

Change the printer setting to "Border" when printing images with the size set to 1:1.

The images may not be printed in 1:1 ratio depending on the printer.

See the instruction manual of the printer or check with the authorized print dealer for further details.

Features Not Available in Combination

Some features cannot be used in combination with other menu settings.

Restricted function	Setting	Description
Flash mode	Focus mode (62)	When (infinity) is selected for shooting, the flash is not available.
	Image quality (75)	When NRW (RAW) images are recorded, red-eye reduction processing is not performed even if (auto with red-eye reduction) is set (including JPEG images when both NRW (RAW) and JPEG images were recorded at the same time).
	Continuous (71)	The flash is not available.
	Auto bracketing (68)	The flash is not available.
Self-timer/Smile timer/Remote control	AF area mode (71)	When Subject tracking is selected for shooting, the self-timer/smile timer/remote control are not available.
Focus mode	AF area mode (71)	When Subject tracking is selected, MF (manual focus) is not available.
Image quality	Continuous (71)	When BSS, Multi-shot 16, Continuous H: 120 fps or Continuous H: 60 fps is selected for shooting, NRW (RAW), NRW (RAW) + Fine or NRW (RAW) + Normal is not available.
	Auto bracketing (68)	When WB bracketing is selected for shooting, NRW (RAW), NRW (RAW) + Fine or NRW (RAW) + Normal is not available.
Image size	Image quality (75)	<ul style="list-style-type: none"> When Image quality is set to NRW (RAW), Image size is fixed at 4000×3000. When the image quality is set to NRW (RAW) + Fine or NRW (RAW) + Normal, Image size of the JPEG image can be set. Note, however, that 3984×2656, 3968×2232 and 3000×3000 cannot be selected.
	Continuous (71)	<ul style="list-style-type: none"> When Multi-shot 16 is selected for shooting, Image size is fixed at (2560 × 1920 pixels). When Continuous H: 120 fps or Continuous H: 60 fps is selected for shooting, Image size is fixed at (1280 × 960 pixels).
ISO sensitivity	Continuous (71)	When Multi-shot 16, Continuous H: 120 fps or Continuous H: 60 fps is selected for shooting, ISO sensitivity is fixed at Auto .
	Active D-Lighting (72)	<ul style="list-style-type: none"> When ISO sensitivity is set to Auto and Active D-Lighting is set to any mode other than Off, the maximum value for ISO sensitivity is set to ISO 800. When Active D-Lighting is set to any mode other than Off for shooting, 1600, 2000, 2500, 3200 or Hi 1 in ISO sensitivity is not available.

Features Not Available in Combination

Restricted function	Setting	Description
ISO sensitivity	Shooting mode of movie custom setting (📖108)	<ul style="list-style-type: none"> If ISO sensitivity is set to Auto when Shooting mode is Manual, ISO sensitivity is fixed at ISO 80. When Shooting mode is Special effects, ISO sensitivity is switched to Auto.
White balance	Picture Control (📖68)	When Monochrome is selected for shooting, White balance is fixed at Auto (normal) .
Picture Control	Active D-Lighting (📖72)	When using Active D-Lighting for shooting, Contrast in manual adjustment cannot be adjusted.
	Shooting mode of movie custom setting (📖108)	When Shooting mode is Special effects , Picture Control is not available.
Metering	Active D-Lighting (📖72)	Metering is reset to Matrix when Active D-Lighting is set to any mode other than Off .
Continuous/ Auto bracketing	Continuous (📖71)/Auto bracketing (📖68)	Continuous and Auto bracketing are not available simultaneously. Auto bracketing is reset to OFF when Continuous is set to any mode other than Single . The setting for Continuous is reset to Single when Auto bracketing is set to any mode other than OFF .
	Self-timer (📖59)/Remote control (📖55)	Continuous H , Continuous M , Continuous L , or BSS and self-timer/remote control are not available simultaneously. When self-timer or remote control is set, a single picture is shot.
	Smile timer (📖60)	When the camera detects smiling faces and the shutter is released, only one picture is shot. If Intvl timer shooting is set, shooting finishes automatically after one picture is shot.
	Image quality (📖75)	BSS , Multi-shot 16 , Continuous H: 120 fps , Continuous H: 60 fps or White balance bracketing cannot be used when Image quality is set to NRW (RAW) , NRW (RAW) + Fine or NRW (RAW) + Normal .
	Picture Control (📖68)	When Monochrome is selected for shooting, White balance bracketing is not available.
AF area mode	Smile timer (📖60)	The camera takes a picture using face detection regardless of the applied AF area mode option.
	Focus mode (📖62)	When set to MF (manual focus), the AF area mode cannot be set.
	Picture Control (📖68)	When Target finding AF is selected and Picture Control is set to Monochrome , AF area mode operates using the Auto setting.
	White balance (📖68)	When Target finding AF is selected, and if the white balance is set to Preset manual , Incandescent , FL3 in Fluorescent or Choose color temp. , or fine adjustment of each white balance setting is performed, AF area mode operates using the Auto setting.

Restricted function	Setting	Description
Autofocus mode	Smile timer (60)	Autofocus mode option cannot be changed when shooting with the smile timer.
	Focus mode (62)	When the focus mode is set to ▲ (Infinity), the focus mode operates using the Single AF setting.
	AF area mode (71)	When AF area mode is set to Face priority , Subject tracking or Target finding AF , AF area mode operates using the Single AF setting.
Built-in ND filter	Shooting mode of movie custom setting (108)	When Shooting mode is set to Special effects , the built-in ND filter is automatically controlled.
Active D-Lighting	ISO sensitivity (68)	When ISO sensitivity is set to 1600, 2000, 2500, 3200 or Hi 1 , Active D-Lighting is not available.
Photo info	Smile timer (60)	The virtual horizon is not displayed when shooting with the smile timer.
	AF area mode (71)	<ul style="list-style-type: none"> The virtual horizon is not displayed when shooting with Face priority. The virtual horizon is not displayed when shooting with Subject tracking. After the subject has been registered (during subject tracking), the histogram is not displayed. The virtual horizon and histogram are not displayed when shooting with Target finding AF.
Print date	Image quality (75)	When Image quality is set to NRW (RAW) , NRW (RAW) + Fine or NRW (RAW) + Normal , print date is not available.
	Continuous (71)	When Continuous H: 120 fps or Continuous H: 60 fps is selected for shooting, print date is not available.
Sound settings	Continuous (71)	When Continuous H , Continuous M , Continuous L , Continuous H: 120 fps , Continuous H: 60 fps , BSS , or Multi-shot 16 is selected for shooting, shutter sound is disabled.
	Auto bracketing (68)	When AE Bracketing (Tv) , AE Bracketing (Av) or AE Bracketing (Sv) is selected for shooting, shutter sound is disabled.
Digital zoom	Smile timer (60)	The digital zoom cannot be used when shooting with the smile timer.
	Focus mode (62)	The digital zoom cannot be used when Mf (manual focus) is selected.
	Image quality (75)	The digital zoom cannot be used when Image quality is set to NRW (RAW) , NRW (RAW) + Fine or NRW (RAW) + Normal .
	Continuous (71)	The digital zoom cannot be used when Multi-shot 16 is selected for shooting.
	AF area mode (71)	The digital zoom cannot be used when shooting with Subject tracking .
	Zoom memory (4, 72)	The digital zoom cannot be used while the Fn1 button is pressed.

Notes on Digital Zoom

- The digital zoom cannot be used with certain shooting modes.
- When the digital zoom is in effect, selectable options for AF area mode or metering mode are restricted (6875).

The Control Range of the Shutter Speed

The control range of the shutter speed differs depending on the aperture value or the ISO sensitivity setting. Additionally, the control range changes in the following continuous shooting settings.

P, S, A, M Modes

Setting		Control range	
		P, S, A mode	M mode
ISO sensitivity (68) ¹	Auto ² , ISO 80-200 ² , ISO 80-400 ² , ISO 80-800 ²	1/4000 ³ to 1 s	1/4000 ³ to 60 s
	ISO 80, 100	1/4000 ³ to 15 s	
	ISO 125	1/4000 ³ to 13 s	
	ISO 160	1/4000 ³ to 10 s	
	ISO 200	1/4000 ³ to 8 s	
	ISO 250	1/4000 ³ to 6 s	
	ISO 320	1/4000 ³ to 5 s	
	ISO 400	1/4000 ³ to 4 s	1/4000 ³ to 30 s
	ISO 500	1/4000 ³ to 3 s	
	ISO 640	1/4000 ³ to 2.5 s	
	ISO 800	1/4000 ³ to 2 s	1/4000 ³ to 15 s
	ISO 1000	1/4000 ³ to 1.6 s	
	ISO 1250	1/4000 ³ to 1.3 s	
	ISO 1600	1/4000 ³ to 1 s	
	ISO 2000	1/4000 ³ to 1/1.3 s	1/4000 ³ to 8 s
	ISO 2500	1/4000 ³ to 1/1.6 s	
	ISO 3200	1/4000 ³ to 1/2 s	
Hi 1	1/4000 ³ to 1/4 s	1/4000 ³ to 2 s	

Setting		Control range	
		P, S, A mode	M mode
Continuous (📖71)	Continuous H, Continuous M, Continuous L, BSS	1/4000 ³ to 1/8 s	1/4000 ³ to 1/8 s
	Multi-shot 16	1/4000 to 1/30 s	1/4000 to 1/30 s
	Continuous H: 120 fps	1/4000 to 1/125 s	1/4000 to 1/125 s
	Continuous H: 60 fps	1/4000 to 1/60 s	1/4000 to 1/60 s
	Intvl timer shooting	1/4000 ³ to 1 s	1/4000 ³ to 1 s

¹ The ISO sensitivity setting is restricted depending on the continuous shooting setting (📖79).

² In **M** mode, the ISO sensitivity is fixed at ISO 80.

³ The maximum shutter speed value varies depending on the aperture value. The shutter speed becomes slower when the aperture value is smaller. When the aperture value is set to f/2 (wide-angle zoom position) or f/4 (telephoto zoom position), the shutter speed can be set to maximum 1/2000 second. When the aperture value is set to f/4.5 to f/8 (wide-angle position) or f/7.1 to f/8 (telephoto zoom position), the shutter speed can be set to maximum 1/4000 second.

During Movie Custom Setting Mode

Setting		Control range
Shooting mode (📖108)	A Mode	1/8000 to 1/30 s
	M Mode	1/4000 to 1/30 s

Focusing on Subject

The focus area or focus range for adjusting focus varies depending on the shooting mode and focus mode (62).

- In **P, S, A, M, U1, U2, U3** or special effects mode, an area for adjusting focus can be set by selecting **AF area mode** (71) in the shooting menu.

Using the Target Finding AF

When **AF area mode** in **P, S, A, M, U1, U2** or **U3** mode is set to **Target finding AF**, the camera will adjust the focus during the following operations if you press the shutter-release button halfway.

- When the camera detects the main subject, it focuses on that subject. When the subject is in focus, the focus areas (up to 12 areas) that match up with the size of the subject will light in green. When detecting a human face, the camera focuses on it as a priority.
- The camera has 9 focus areas, and if it does not detect the main subject, it automatically selects the focus areas containing the subject closest to the camera. When the subject is in focus, the focus areas that are in focus light in green.

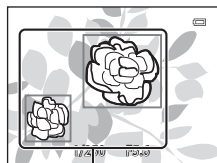

Focus area

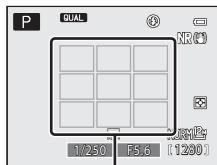

Focus area

Notes on Target Finding AF

- Depending on shooting conditions, the subject that the camera determines to be the main subject may vary.
- The camera may not detect the main subject appropriately in the following situations:
 - When the image shown on the monitor is very dark or bright
 - When the main subject lacks clearly defined colors
 - When the shot is framed so that the main subject is on the edge of the monitor
 - When the main subject is composed of a repeating pattern
- The camera has 9 focus areas, and in the following situations, it automatically selects the focus areas containing the subject closest to the camera:
 - When **White balance** is set to **Preset manual, Incandescent, FL3** in **Fluorescent** or **Choose color temp.**, or fine adjustment of each white balance setting is performed
 - When **Picture Control** is set to **Monochrome**

Using Face Detection

In the following settings, the camera uses face detection to automatically focus on human faces. If the camera detects more than one face, a double border is displayed around the face that the camera will focus on, and single borders are displayed around the other faces.

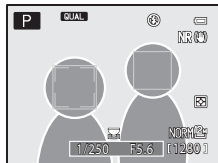

Setting	Number of faces that can be detected	Focus area (double border)
Face priority is selected for AF area mode (📖71)	Up to 12	The face closest to the camera
Scene auto selector, Portrait, Night portrait, Pet portrait* scene mode (📖35)		
☺ (Smile timer) (📖60)	Up to 3	The face closest to the center of the frame

* If **Pet portrait auto release** is switched to **OFF** when **Pet portrait** is selected, the camera will detect human faces (📖42).

- When using **Face priority**, if the shutter-release button is pressed halfway while no faces are detected or while framing a shot with no faces in it, the camera automatically selects the focus areas (up to 9) that contain the subject closest to the camera.
- When **Scene auto selector** is selected, the focus area changes depending on which scene the camera selects.
- When using **Portrait** or **Night portrait**, if no faces are detected when the shutter-release button is pressed halfway, the camera will focus on the subject at the center of the frame.
- When ☺ (smile timer) is selected, if you press the shutter-release button halfway while no faces are detected, the camera will focus on the subject at the center of the frame.

✓ Notes on Face Detection

- The camera's ability to detect faces depends on a variety of factors, including whether or not the subject is facing the camera. Additionally, the camera may be unable to detect faces in the following situations:
 - When faces are partially hidden by sunglasses or otherwise obstructed
 - When faces take up too much or too little of the frame
- When the frame includes more than one face, the faces detected by the camera and the face on which the camera focuses depend upon a variety of factors, including the direction in which the subject is facing.
- In some rare cases, such as those described in "Autofocus" (📖86), the subject may not be in focus even though the double border turns green. If the camera does not focus, try "Focus Lock" (📖86).

📄 Viewing Pictures Taken Using Face Detection

When zooming in on an image displayed in full-frame playback mode by rotating the zoom control toward **T** (📖), the image is enlarged at the center of the face that was detected during shooting (📖91).

Focus Lock

Use focus lock to focus on off-center subjects when center is selected for AF area mode.

- Be sure that the distance between the camera and the subject does not change.
- When the shutter-release button is pressed halfway, the exposure is locked.

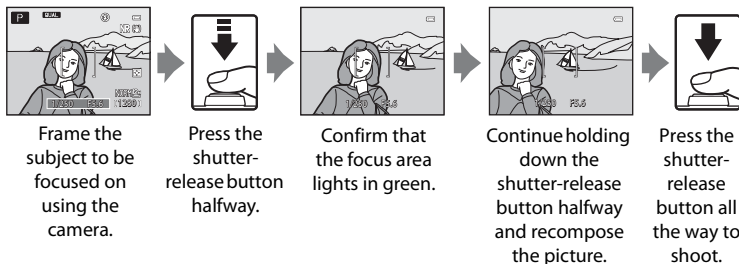

- Instead of pressing the shutter-release button halfway, you can also press the **AE-L/AF-L** (AE-L/AF-L) button to shoot with focus lock (📖113) (except for **Scene auto selector** (📖36) in scene mode).

Autofocus

Autofocus may not perform as expected in the following situations. In some rare cases, the subject may not be in focus despite the fact that the focus area or focus indicator lights in green.

- Subject is very dark
- Objects of sharply differing brightness are included in the scene (e.g. the sun behind the subject makes that subject appear very dark)
- No contrast between the subject and surroundings (e.g. a portrait subject, wearing a white shirt, is standing in front of a white wall)
- Several objects are at different distances from the camera (e.g., an animal inside a cage)
- Subjects with repeating patterns (window blinds, buildings with multiple rows of similarly shaped windows, etc.)
- Subject is moving rapidly

In these situations, try pressing the shutter-release button halfway to refocus several times, or focus on another subject and use focus lock. When using focus lock, be sure that the distance between the camera and the subject with which focus was locked is the same as that for the actual subject.

The camera can also focus using manual focus (📖62, 📷2).

Speedlights (External Flash Unit)



With this camera, various features are available in combination with the Speedlight (external flash) supported by the Nikon Creative Lighting System (CLS) (88). Use the Speedlight when the built-in flash cannot provide sufficient lighting.

The following Speedlights and Wireless Speedlight Commander can be used for the camera.

Speedlights	SB-910, SB-900, SB-800, SB-700, SB-600, SB-400, SB-R200*
Wireless Speedlight Commander	SU-800

* Speedlight used for remote flash. Attachment Ring SX-1 cannot be mounted on this camera. To use the SB-R200, it must be attached to the Speedlight Stand AS-20.

See our latest product catalogs or websites for up-to-date information on Speedlights that can be used for the COOLPIX P7700.

The built-in flash is set to  (off) automatically when using Speedlights or Wireless Speedlight Commander. While  is displayed on the monitor screen, the Speedlight flash mode is also displayed on the monitor, and it can be set with the same procedure as the built-in flash (56).

How to Attach the Speedlight

- Remove the accessory shoe cover before attaching the Speedlight or Wireless Speedlight Commander as shown on the right (1).
- When the built-in flash is raised, gently push to lower the flash until it clicks shut.
- Refer to the instruction manual of your Speedlight for more information on how to attach the Speedlight and details on how to use it.
- Attach the accessory shoe cover when the Speedlight is not in use.

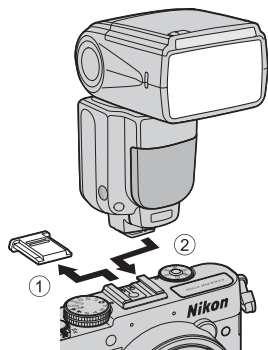

Note on External Flash

Attempting to attach external flashes that do not support this camera may damage the camera and the external flash.

Speedlights (External Flash Unit)

Use Only Nikon Flash Accessories

Use only Nikon Speedlights. Negative voltages or voltages over 250 V applied to the accessory shoe could not only prevent normal operation, but damage the sync circuitry of the camera or flash.

Features That Can Be Used in Combination With the Speedlight

- SB-910, SB-900, SB-800, SB-700 or SB-600

			CLS compatible Speedlight				
			SB-910 SB-900	SB-800	SB-700	SB-600	
Single flash unit	i-TTL	i-TTL-BL flash ¹	✓	✓	✓	✓	
		Standard i-TTL flash	✓ ³	✓ ³	✓	✓ ³	
	AA	Auto aperture flash	✓ ⁴	✓ ⁴	-	-	
	A	Non-TTL auto flash	✓ ⁴	✓ ⁴	-	-	
	GN	Distance priority manual flash	✓	✓	✓	-	
	M	Manual flash	✓	✓	✓	✓	
	RPT	Repeating flash	✓	✓	-	-	
Advanced wireless lighting (AWL)	Master flash unit	Instruction to flash unit ²		✓	✓	✓	-
		i-TTL	i-TTL flash	✓	✓	✓	-
		AA	Auto aperture flash	✓	✓	-	-
		M	Manual flash	✓	✓	✓	-
		RPT	Repeating flash	✓	✓	-	-
	Remote flash unit	i-TTL	i-TTL flash	✓	✓	✓	✓
		AA	Auto aperture flash	✓	✓	-	-
		M	Manual flash	✓	✓	✓	✓
		RPT	Repeating flash	✓	✓	✓	✓
	Transmission of flash color temperature information			✓	✓	✓	✓
Flash mode setting from camera			-	-	-	-	

¹ Not available when metering mode is set to **Spot**.

² The remote flash unit can control Group A only.

³ Can also be set on the Speedlight.

⁴ The selection of AA mode and A mode is performed using the custom setting for the Speedlight.

- SU-800, SB-400 or SB-R200

			CLS compatible Speedlight			
			SU-800	SB-400	SB-R200	
Single flash unit	i-TTL	i-TTL-BL flash ¹	-	✓	-	
		Standard i-TTL flash	-	✓	-	
	AA	Auto aperture flash	-	-	-	
	A	Non-TTL auto flash	-	-	-	
	GN	Distance priority manual flash	-	-	-	
	M	Manual flash	-	✓ ³	-	
	RPT	Repeating flash	-	-	-	
Advanced wireless lighting (AWL)	Master flash unit	Instruction to flash unit ²		✓	-	-
		i-TTL	i-TTL flash	-	-	-
		AA	Auto aperture flash	-	-	-
		M	Manual flash	-	-	-
		RPT	Repeating flash	-	-	-
	Remote flash unit	i-TTL	i-TTL flash	-	-	✓
		AA	Auto aperture flash	-	-	-
		M	Manual flash	-	-	✓
		RPT	Repeating flash	-	-	-
	Transmission of flash color temperature information			-	✓	-
Flash mode setting from camera			-	✓	-	

¹ Not available when metering mode is set to **Spot**.

² The remote flash unit can control Group A only.

³ This setting can be made using the flash mode (□56) of this camera. When **M4** (manual) is set, the flash is forcibly fired at the flash output that was set. If other flash mode is set, i-TTL Flash is enabled.

Notes on i-TTL Flash

- The monitor pre-flashes are fired to measure the reflecting light from a subject in order to adjust the flash output of the Speedlight.
- When shooting using i-TTL-BL flash, the flash output is adjusted with consideration for the balance between a subject and its background light.
- When shooting using Standard i-TTL flash, the flash output is adjusted to achieve the standard exposure value for the main subject without consideration for the background light. This setting is optimal for taking pictures with emphasis on the main subjects.
- When shooting using i-TTL flash, set the flash control mode of the Speedlight to i-TTL before taking pictures (except SB-400).
- When shooting using SB-700 or SB-400 and if **Metering** of the camera is set to **Matrix** or **Center-weighted**, i-TTL-BL flash is set. If **Metering** of the camera is set to **Spot**, Standard i-TTL flash is set.

Speedlights (External Flash Unit)

Notes on Speedlights

- This camera does not support Auto FP High-Speed Sync, FV lock, red-eye reduction or AF-assist for multi-area AF when using Speedlights.
- The power zoom function can be used with Speedlights SB-910, SB-900, SB-800, SB-700 or SB-600 and the zoom head position is automatically set depending on the focal length of the lens.
- When using Speedlights SB-910, SB-900, SB-800, SB-700 or SB-600, the edges of pictures shot at ranges less than 2 m (6 ft 7 in.) on the wide-angle zoom position may appear dark. In such cases, use the wide panel.
- When set to STBY (standby), the Speedlight turns on and off at the same time as the camera. Confirm on the Speedlight that the Ready-light is on.
- Advanced Wireless Lighting shooting can be performed by setting SB-910, SB-900, SB-800 or SB-700 attached to COOLPIX P7700 to master flash, or by setting SU-800 to the Commander mode, and setting SB-910, SB-900, SB-800, SB-700, SB-600 or SB-R200 to remote flash. (When shooting with COOLPIX P7700, the remote flash setting is only applicable to Group A.)
- Advanced Wireless Lighting shooting can be performed also by using the built-in flash in Commander mode. (Only applicable to Group A and fixed at 3 CH) (☐57, 72, 56).
- Refer to the instruction manual of your Speedlight for more information.

Notes on Using the Remote Flash Unit

- Set up the remote flash unit in a position close to the subject from the camera to ensure the light from the Speedlight to enter the sensor window.
- Aside from monitor pre-flashes, the master flash unit emits a minute amount of flashes to control the remote flash unit. When shooting a subject at a short distance from the master flash unit, these minute amounts of flashes may cause adverse effects and the proper exposure may not be achieved. To reduce such adverse effects, use the wide panel for the master flash when the master flash unit is directly facing a subject that is being shot at a short distance.

Playback Features

Playback Zoom

Select an image to be enlarged in playback mode and rotate the zoom control toward **T** (Q).

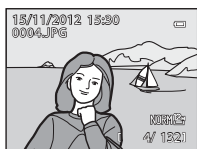
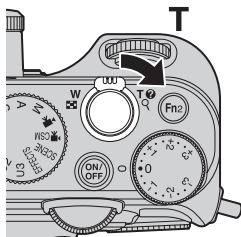

Image is displayed in full-frame playback mode.



Image is zoomed in.

Display position guide

Operations During Playback Zoom

Function	Operation	Description
Adjusting the magnification	W (Q) / T (Q)	<ul style="list-style-type: none"> The zoom increases up to about 10x. The zoom can also be adjusted by rotating the command dial.
Moving the display position		Move the display position.
Cropping	MENU	Crop only the displayed area of the image and save as a separate file (18).
Returning to full-frame playback mode	OK	Return to full-frame playback mode.

Enlarging Images Recorded with Face Detection or Pet Detection

Pictures taken using face detection (85) or pet detection (42) are enlarged at the center of the face that was detected during shooting (excepting images recorded by **Continuous** (71) or **AE Bracketing (Tv), AE Bracketing (Av) or AE Bracketing (Sv)** (68)). If the camera detected multiple faces, use **▲**, **▼**, **◀**, and **▶** to display a different face. Change the zoom ratio and press **▲**, **▼**, **◀**, or **▶** to zoom in on an area of the image where there are no faces.

Viewing Several Images (Thumbnail Playback and Calendar Display)

Rotate the zoom control toward **W** () in playback mode.

This function will display several images at the same time, making it easy to find the desired image.

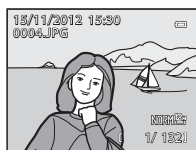
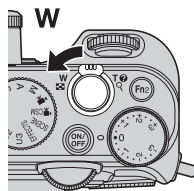

Full-frame playback mode









Image thumbnail display
(4, 9, 16 and 72 images per screen)



Calendar display

Operations During Thumbnail Playback and Calendar Display

Function	Operation	Description
Changing the number of images displayed	W () / T ()	<ul style="list-style-type: none"> Change the number of images to be displayed (4, 9, 16 and 72 images per screen). When 72 images are displayed, rotate the zoom control toward W () to switch to calendar display. When calendar is displayed, rotate the zoom control toward T () to switch to 72-image display.
Selecting an image or date		<ul style="list-style-type: none"> In thumbnail display mode, select an image. In calendar display mode, select a date. An image or date can also be selected by rotating the main command dial.
Returning to full-frame playback mode		<ul style="list-style-type: none"> In thumbnail display mode, the selected image is displayed in full-frame playback mode. In calendar display mode, the first image captured on the selected date is displayed in full-frame playback mode.

Note on Calendar display

Pictures taken when the camera's date is not set are treated as images captured on "January 1, 2012."

Features That Can Be Set Using the MENU (Menu) button (Playback Mode)



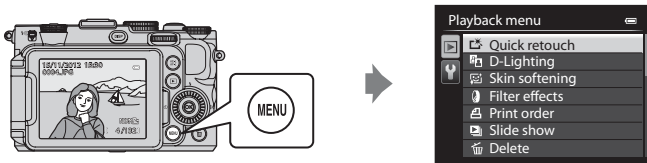













When viewing images in full-frame playback mode or thumbnail playback mode, press the **MENU** button to set the playback menu (📖10).



Available Playback Menus

Option	Description	📖
🖨️ Quick retouch ^{1, 2, 3}	Create retouched copies in which contrast and saturation have been enhanced.	👓12
📷 D-Lighting ^{1, 3}	Create copies with enhanced brightness and contrast, brightening dark portions of an image.	👓12
👤 Skin softening ^{1, 2, 3}	When this feature is enabled, the camera detects faces in pictures taken and creates a copy with softer facial skin tones.	👓13
🌀 Filter effects ^{1, 3}	Apply a variety of effects using digital filter. The available effects are Soft, Selective color, Cross screen, Fisheye, Miniature effect, Painting and Vignette .	👓14
🖨️ Print order ^{4, 5}	When using a printer to print images saved on the memory card, the print order function can be used to select which images are printed, and how many copies of each image are printed.	👓60
📺 Slide show	Images saved in the internal memory or on a memory card are played back in an automatic slide show.	👓62
🗑️ Delete ⁵	Delete an image. Multiple images can be deleted.	👓63
🔒 Protect ⁵	Protect selected images and movies from accidental deletion.	👓64
🔄 Rotate image ^{3, 4, 5}	Specify the orientation in which saved images are displayed in playback mode.	👓64
🖼️ Small picture ^{1, 3}	Create a small copy of the picture taken. This feature is useful for creating copies for display on Web pages or e-mail attachments.	👓15

Features That Can Be Set Using the MENU (Menu) button (Playback Mode)

Option	Description	
 Voice memo ^{3, 6}	Use the camera's microphone to record voice memos and attach them to the picture taken. Playback and deletion of voice memos can also be performed.	 65
 Copy ⁵	Copy images between the internal memory and a memory card. This function can also be used to copy movies.	 66
 Black border ^{1, 3}	Create a new picture surrounded by a black border.	 15
 Straighten ^{1, 3}	Compensate for the slanting of pictures taken.	 16
NRW NRW (RAW) processing ^{1, 3, 5}	Create JPEG-format copies by performing RAW processing within the camera for NRW (RAW) images ( 75) without having to use a computer.	 16
 Sequence display options	Display a sequence of images shot continuously as individual images, or display only the key picture of a sequence.	 67
 Choose key picture ⁵	Change the key picture for the series of pictures that were shot continuously (Pictures in a sequence,  8). <ul style="list-style-type: none"> When changing this setting, select the desired sequence before displaying the menu. 	 67

¹ This function is used to edit the currently selected image and save it as a separate file from the original file.

Note, however, that the following pictures cannot be edited.

- Pictures taken using an aspect ratio of 16:9, 3:2, or 1:1 (except when using the black border editing function)
- Pictures taken using **Easy panorama** or **3D photography**

Note also that there is a restriction on retouching edited images (11).



² Pictures that were extracted from a movie cannot be edited using the quick retouch or skin softening function.

³ This function cannot be used for pictures in the sequence when only the key picture is displayed. To use this function, press the  button to display individual images before displaying the menu.

⁴ The function cannot be applied to pictures taken in scene mode **3D photography**.

⁵ Select an image in the image selection screen. See "Using the Screen for Selecting Images" (95) for more information.

⁶ A voice memo cannot be attached to a picture that was shot using **Easy panorama**.

See "Editing Still Images" (10) and "The Playback Menu" (60) in the Reference Section for more information about each function.

Using the Screen for Selecting Images

The image selection screen is displayed in the following menus.

Only one image can be selected for some menu items, while for other menu items, multiple images can be selected.

Functions for which only one image can be selected	Functions for which multiple images can be selected
<ul style="list-style-type: none"> • Playback menu: Rotate image* (F64), NRW (RAW) processing (F16), Choose key picture (F67) • Setup menu: Select an image in Welcome screen (F68) • PictBridge (A printer is connected) : Print selection (F22) 	<ul style="list-style-type: none"> • Playback menu: Select images in Print order (F60), Erase selected images in Delete (F63), Protect (F64), Selected images in Copy (F66) • PictBridge (A printer is connected) : Print selection in Print menu (F23)

Follow the procedure described below to select images.

1 Rotate the multi selector, or press ◀ or ▶ to choose the desired image.

- Rotate the zoom control toward **T** (Q) to switch to full-frame playback mode, or **W** (R) to switch to 12 thumbnails display.
- For functions for which only one image can be selected, proceed to step 3.



2 Press ▲ or ▼ to select ON or OFF (or the number of copies).

- When **ON** is selected, a check mark (✓) is displayed with the image. Repeat steps 1 and 2 to select additional images.



3 Press the (OK) button to apply the image selection.

- With selections such as **Erase selected images**, the confirmation dialog is displayed. Follow the instructions on the screen.

Connecting the Camera to a TV, Computer, or Printer

You can enhance your enjoyment of images and movies by connecting the camera to a TV, computer, or printer.

- Before connecting the camera to an external device, make sure the remaining battery level is sufficient and turn the camera off. For information about the connection methods and subsequent operations, refer to the documentation included with the device in addition to this document.

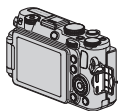

How to open the connector cover



Insert the plug straight.

Viewing images on a TV

 19



You can view the camera's images and movies on a TV.
Connection method: Connect the video and audio plugs of the included Audio Video Cable to the TV's input jacks. Alternatively, connect a commercially available HDMI cable (Type C) to the TV's HDMI input jack.

Viewing and organizing images on a computer

 97



If you transfer images to a computer, you can perform simple retouching and manage image data in addition to playing back images and movies.

Connection method: Connect the camera to the computer's USB input jack with the included USB Cable.

- Before connecting to a computer, install ViewNX 2 on the computer using the included ViewNX 2 CD-ROM. See  99 for more information about using the included ViewNX 2 CD-ROM, and transferring images to a computer.

Printing images without using a computer

 21



If you connect the camera to a PictBridge-compatible printer, you can print images without using a computer.

Connection method: Connect the camera directly to the printer's USB input jack with the included USB Cable.

Using ViewNX 2

ViewNX 2 is an all-in-one software package which enables you to transfer, view, edit and share images.

Install ViewNX 2 using the included ViewNX 2 CD-ROM.



Installing ViewNX 2

Compatible Operating Systems

Windows

- Windows 7 Home Basic/Home Premium/Professional/Enterprise/Ultimate (Service Pack 1)
- Windows Vista Home Basic/Home Premium/Business/Enterprise/Ultimate (Service Pack 2)
- Windows XP Home Edition/Professional (Service Pack 3)

Macintosh

- Mac OS X (version 10.6.8, 10.7.4)

Refer to the Nikon website for the latest information on operating system compatibility.

1 Start the computer and insert the ViewNX 2 CD-ROM into the CD-ROM drive.

- Mac OS: When the **ViewNX 2** window is displayed, double-click the **Welcome** icon.

2 Select a language in the language selection dialog to open the installation window.

- If the desired language is not available, click **Region Selection** to choose a different region and then choose the desired language (the **Region Selection** button is not available in the European release).
- Click **Next** to display the installation window.

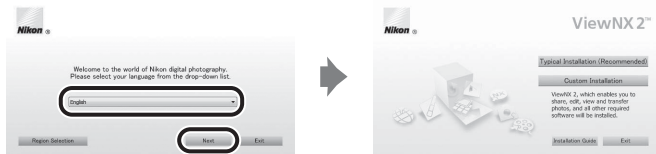

3 Start the installer.

- We recommend clicking **Installation Guide** in the installation window to check the installation help information and system requirements before installing **ViewNX 2**.
- Click **Typical Installation (Recommended)** in the installation window.
- Follow the on-screen instructions to install the software.

4 Exit the installer when the installation completion screen is displayed.

- Windows: Click **Yes**.
- Mac OS: Click **OK**.

The following software is installed:

- ViewNX 2 (consisting of the three modules below)
 - Nikon Transfer 2: For transferring images to the computer
 - ViewNX 2: For viewing, editing, and printing transferred images
 - Nikon Movie Editor: For basic editing of transferred movies
- Panorama Maker (for creating a single panorama photo using a series of images shot in panorama assist scene mode)
- QuickTime (Windows only)

5 Remove the ViewNX 2 CD-ROM from the CD-ROM drive.

Transferring Images to the Computer

1 Choose how images will be copied to the computer.

Choose one of the following methods:

- **Direct USB connection:** Turn the camera off and ensure that the memory card is inserted in the camera. Connect the camera to the computer using the included USB Cable. The camera automatically turns on. To transfer images that are saved in the camera's internal memory, remove the memory card from the camera before connecting it to the computer.

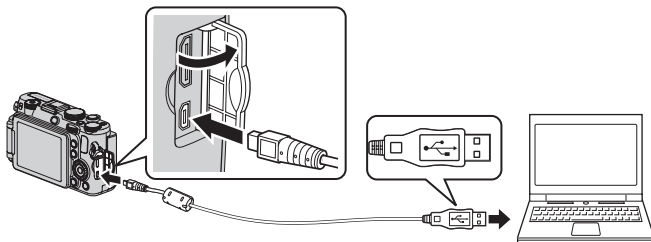

- **SD card slot:** If your computer is equipped with an SD card slot, the card can be inserted directly in the slot.
- **SD card reader:** Connect a card reader (available separately from third-party suppliers) to the computer and insert the memory card.

If a message is displayed prompting you to choose a program, select Nikon Transfer 2.

• When using Windows 7

If the dialog shown at right is displayed, follow the steps below to select Nikon Transfer 2.

- 1 Under **Import pictures and videos**, click **Change program**. A program selection dialog will be displayed; select **Import File using Nikon Transfer 2** and click **OK**.
- 2 Double-click **Import File**.



If the memory card contains a large number of images, it may take a while for Nikon Transfer 2 to start. Wait until Nikon Transfer 2 starts.

✓ Connecting the USB Cable

The connection may not be recognized if the camera is connected to the computer via a USB hub.

2 Transfer images to the computer.

- Confirm that the name of the connected camera or removable disk is displayed as the “Source” on the “Options” title bar of Nikon Transfer 2 (①).
- Click **Start Transfer** (②).

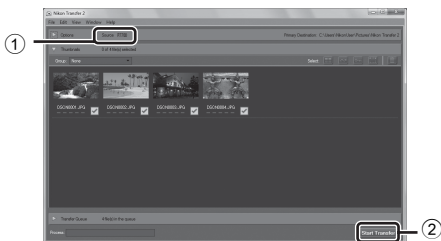

- At default settings, all the images on the memory card will be copied to the computer.

3 Terminate the connection.

- If the camera is connected to the computer, turn the camera off and disconnect the USB cable.
- If you are using a card reader or card slot, choose the appropriate option in the computer operating system to eject the removable disk corresponding to the memory card and then remove the card from the card reader or card slot.

Viewing Images

Start ViewNX 2.

- Images are displayed in ViewNX 2 when transfer is complete.
- Consult online help for more information on using ViewNX 2.





Starting ViewNX 2 Manually

- **Windows:** Double-click the **ViewNX 2** shortcut on the desktop.
- **Mac OS:** Click the **ViewNX 2** icon in the Dock.



Recording and Playing Back Movies

Recording Movies

Movies can be recorded using the following 2 modes.

 (movie) mode	You can record basic movies (with sound). When Movie options is set to HS movies, you can record slow motion movies and fast motion movies ( 29).
 CSM (movie custom setting) mode	You can set the Shooting mode and ISO sensitivity and enjoy recording more authentic movies (with sound).

1 Rotate the mode dial to (or CSM).

- The movie options icon indicates the type of movie recorded. The default setting is  **HD 1080p★ (1920×1080)** (28).
- The amount of available recording time is displayed on the monitor screen. When a memory card is not inserted,  is displayed and movie is saved to the internal memory.

* The maximum recording time shown in the illustration differs from the actual value.

Available movie recording time*

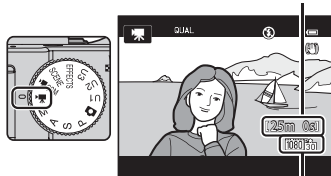

Movie option

2 Press the shutter-release button all the way to start recording.

- The camera focuses at the center of the frame. The focus area is not displayed when the movie is recorded.
- See “Focus and Exposure During Movie Recording” (102) for more information.
- Recording stops automatically when the maximum movie length has been recorded.

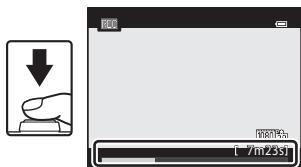

3 Press the shutter-release button all the way to end recording.

Focus and Exposure During Movie Recording

- The focus can be adjusted during movie recording in the following manner in accordance with the **Autofocus mode** (📖108) setting of the movie menu.
 - **AF-S Single AF** (default setting): The focus is locked when movie recording starts. To perform the autofocus function during movie recording, press the AE-L/AF-L (AE-L/AF-L) button (📖2).
 - **AF-F Full-time AF**: The focus is adjusted repeatedly even during movie recording. To lock the exposure or focus during movie recording, press the AE-L/AF-L (AE-L/AF-L) button. To cancel the exposure or focus, press the AE-L/AF-L (AE-L/AF-L) button again.
- When the focus mode (📖62) is **MF** (manual focus), adjust the focus manually. The focus can be adjusted by pressing the multi selector ▲ (far) or ▼ (near) while recording movies.
- Autofocus may not perform as expected (📖86). Should this occur, try **MF** (manual focus) (📖62, 📖2) or set **Autofocus mode** in the movie menu to **AF-S Single AF** (default setting) and then use focus lock (📖86) to record.
- When **Shooting mode** (📖108) of the movie custom setting mode is set to **Aperture-priority auto** or **Manual**, set the aperture value or shutter speed before recording a movie (📖48). The aperture value and shutter speed cannot be set during movie recording.

✓ Notes on Using Zoom During Movie Recording

- The zoom indicator is not displayed during movie recording.
- The camera can zoom up to 2x with digital zoom during movie recording.
- When the digital zoom is used, the image quality will deteriorate. When the movie options setting is **720p HD 720p (1280×720)** and **VGA (640×480)**, the digital zoom can be used up to 1.55x and 2x, respectively without causing the image quality deteriorate.
- If you start recording a movie without using digital zoom, and you keep rotating the zoom control toward **T**, the zoom stops at the maximum optical zoom ratio. Remove your finger from the zoom control and then rotate it again toward **T** to activate digital zoom. When movie recording ends, digital zoom is cancelled.
- When **Shooting mode** (📖108) of the movie custom setting mode is set to **Aperture-priority auto** or **Manual**, optical zoom cannot be used during movie recording.

✓ Note on Recording Images and Saving Movies

The indicator showing the number of exposures remaining or the indicator showing the maximum movie length flashes while images are being recorded or while a movie is being saved. **Do not open the battery-chamber/memory card slot cover or remove the battery or memory card while an indicator is flashing.** Doing this could result in loss of data, or in damage to the camera or the memory card.

✓ Notes on Movie Recording

- When saving a movie onto a memory card, a memory card with an SD speed class of Class 6 or higher is recommended (📖21). If the transfer speed of the card is slow, the movie recording may end unexpectedly.
- The sounds of zoom control operation, zoom, autofocus, vibration reduction or aperture control when the brightness changes may be recorded.
- The following phenomena may be seen on the monitor screen while recording movies. These phenomena are saved in the recorded movies.
 - Banding may occur in images under fluorescent, mercury-vapor, or sodium-vapor lighting
 - Subjects that move quickly from one side of the frame to the other, such as a moving train or car, may appear skewed
 - The entire movie image may be skewed when the camera is panned
 - Lighting or other bright areas may leave residual images when the camera is moved
- The flash does not fire.

✓ Notes on the Camera Temperature

- The camera may become warm when recording movies for an extended period of time or when the camera is used in a hot area.
- When the temperature inside the camera becomes extremely high during movie recording, the camera may automatically stop recording to prevent internal damage to the camera. A 10-second countdown indicator (🔊10s) appears on the monitor, and then the camera will turn off after 5 seconds.



Recording HS (High Speed) Movies

When **Movie options** (📖106) in quick menu is set to **VGA₁₂₀ HS 120 fps (640×480)**, **720₆₀ HS 60 fps (1280×720)** or **1080₁₅ HS 15 fps (1920×1080)** in  (movie) mode, movies that can be played back in slow motion or fast motion can be recorded.

External Microphones

Instead of the built-in microphone, a Stereo Microphone ME-1 (available separately; 🎧102) can be connected to the external microphone connector (📖2) to record sound during movie recording.

More Information

- See “Maximum Movie Length” (🎧29) for more information.
- See “File and Folder Names” (🎧100) for more information.

Changing Movie Mode and Movie Custom Setting Mode Settings

- Features That Can Be Set Using the Multi Selector → 📖55
- Exposure Compensation → 📖66
- Features That Can Be Set Using the Quick Menu Dial → 📖105
- Features That Can Be Set Using the **MENU** (Menu) Button.
 - Movie menu → 📖108
 - Setup menu → 📖110

Features That Can Be Set Using the Quick Menu Dial (Movie Mode, Movie Custom Setting Mode)

When the quick menu dial is rotated while recording movies, the quick menu is displayed for the function that is selected with the mark. When the quick menu is displayed, the quick menu dial mark lights.

- See “Using the Quick Menu” (📖69) for more information.

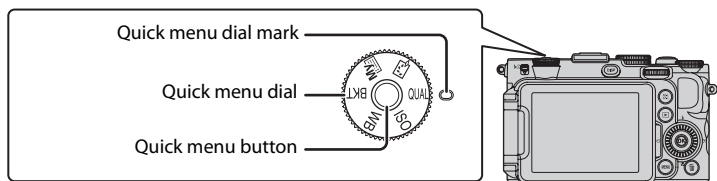













Available functions differ according to the movie mode.

Dial position	Function	▶ (movie)	▶ CSM (movie custom setting)
QUAL	Movie options (📖106)	✓	✓
ISO	ISO sensitivity (📖106)	-	✓
WB	White balance (📖106)	✓	✓
BKT	Auto bracketing	-	-
My Menu	My Menu	-	-
Picture Control	Picture Control (📖106)	-	✓

✍ Features Not Available in Combination

Some features cannot be used in combination with other menu settings (📖79).

Available Quick Menu

Option	Description	
QUAL Movie options	Select the type of movie to be recorded. In  (movie) mode, you can set high speed (HS) movies that can be played back in slow motion or fast motion. The default setting is  HD 1080p ★ (1920×1080) .	 28
ISO ISO sensitivity	Higher ISO sensitivity allows you to take pictures of darker subjects. When ISO sensitivity is set to Auto (default setting), the camera sets the ISO sensitivity automatically. <ul style="list-style-type: none"> If ISO sensitivity is set to Auto when Shooting mode of the movie custom setting menu ( 107) is Manual, ISO sensitivity is fixed at ISO 80. 	 31
WB White balance	Adjust colors in the image closer to the colors as they appear to the eye. Although Auto (normal) (default setting) can be used under most types of lighting, you can apply the white balance setting suited to the sky conditions or light source to achieve better results if the default setting results are unsatisfactory. <ul style="list-style-type: none"> To adjust white balance using color temperature (), select  Choose color temp. of White balance in the first line, and then select the value in Choose color temp. in the second line. The preset value for preset manual applies commonly to P, S, A, M, U1, U2 and U3 shooting modes, and movie mode. 	 33
 Picture Control	Change the settings for image recording according to the shooting scene or your preferences. The default setting is Standard . <ul style="list-style-type: none"> When Shooting mode ( 108) of the movie menu is set to Aperture-priority auto or Manual, Picture Control can be set. 	 38

Features That Can Be Set Using the MENU (Menu) Button (Movie Mode, Movie Custom Setting Mode)

In movie mode or movie custom setting mode, press the **MENU** button to set movie menu or movie custom setting menu.

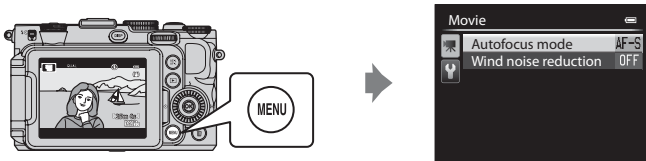

Available functions differ according to the movie mode.

Function	▶ (movie)	▶ CSM (movie custom setting)
Shooting mode (📖108)	–	✓
Custom Picture Control (📖108)	–	✓
Autofocus mode (📖108)	✓	✓
Built-in ND filter (📖108)	–	✓
Wind noise reduction (📖108)	✓	✓







✎ Features Not Available in Combination

Some features cannot be used in combination with other menu settings (📖79).

✎ More Information

See “Basic Menu Operations” (📖10) for more information.

Available Movie Menus

Option	Description	
Shooting mode	Select the standard shooting mode from Aperture-priority auto (default setting), Manual or Special effects . When Special effects is selected, select one of the 7 special effects. • Painting (default setting), Cross process , Soft , Nostalgic sepia , High key , Low key , Selective color See  45 for more information on characteristics of each special effect.	 58
Custom Picture Control (COOLPIX Custom Picture Control)	Allow you to store the settings customized in COOLPIX Picture Control, which can set picture editing options for recording images according to the shooting scene or your preferences.	 42
Autofocus mode	Select how the camera focuses when recording normal speed movies. Single AF (default setting) where the focus is locked when movie recording begins, or Full-time AF where the camera focuses continuously during movie recording can be selected. When Full-time AF is selected, the sound of the camera focusing may be heard in recorded movies. If you want to prevent the sound of the camera focusing from being recorded, select Single AF .	 59
Built-in ND filter	Select On or Off (default setting) for the built-in ND filter. Set this feature to On in conditions such as too bright overexposure results from the subject, so that the amount of light that enters camera is reduced. • When Shooting mode is set to Special effects , the built-in ND filter is automatically controlled.	 52
Wind noise reduction	Set whether or not to reduce wind noise from the microphone during movie recording. During playback, not only wind noise, but other sounds may also become difficult to hear. The default setting is Off .	 59

Playing Back Movies

1 Press the  (playback) button to select playback mode.

- Press the multi selector to select a movie.
- Movies can be recognized by the movie options icon ()101).

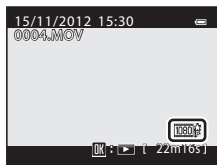



2 Press the  button to play back a movie.

Operations Available During Movie Playback

Rotate the multi selector or the main command dial to fast forward or rewind.

Playback controls appear at the top of the monitor.

Press the multi selector  or  or sub-command dial to select an icon of playback control, then press the  button to perform the following operations.

















Pausing





During playback

Volume indicator

To	Use	Description
Rewind		Rewind the movie while the  button is pressed down.
Advance		Advance the movie while the  button is pressed down.
Pause		The following operations can be performed with the playback controls at the top of the monitor while playback is paused.
		 Rewind the movie by one frame. Hold down the  button to rewind continuously.*
		 Advance the movie by one frame. Hold down the  button to advance continuously.*
		 Extract and save only the required parts of the movie ()26).
		 Save the extracted frame from a movie as a still picture ()27).
End		Resume playback.
End		Return to full-frame playback mode.

* The movie can also be advanced or rewound by one frame by rotating the multi selector or main command dial.



To delete a movie, use full-frame playback mode ()32) or thumbnail playback mode ()92) to select a movie and press the  button ()33).

Adjusting the Volume

Press the zoom control **T/W** ()2) during playback.









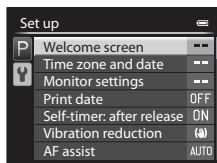

General Camera Setup















The Setup Menu

Press the MENU button →  (setup) tab ()

From the menu screen, select the  tab to display the setup menu, and then you can change the following settings.















Option	Description	
Welcome screen	Set whether or not the welcome screen is displayed when power is turned on. The welcome screen image can be selected.	 68
Time zone and date	Set settings related to the camera's date and time. The Time zone setting allows you to specify the time zone where the camera is mainly used and whether or not daylight saving time is in effect. When the  travel destination is set, the camera automatically calculates the time difference between the travel destination and the  home time zone, and saves images using the date and time of the travel destination.	 69
Monitor settings	Set the image display after shooting and the screen brightness. When using Photo info , set whether or not to display virtual horizon, histograms, and framing grid on the monitor screen. When using Virtual horizon display , set the virtual horizon indicator to either Circle (default setting) or Bars .	 71
Print date	Imprint the shooting date and time on pictures at the time of shooting. The default setting is Off . Dates cannot be imprinted in the following situations. - When the scene mode is set to Easy panorama , Panorama assist , or 3D photography - When Image quality () is set to NRW (RAW) , NRW (RAW) + Fine or NRW (RAW) + Normal - When Continuous H: 120 fps or Continuous H: 60 fps is selected for Continuous () - During movie recording	 72
Self-timer: after release	Set whether or not to cancel the setting after shooting pictures with the self-timer. The default setting is Exit self-timer mode .	 73









Option	Description	
Vibration reduction	Reduce blurring caused by camera shake when shooting. The default setting is On . <ul style="list-style-type: none"> When using a tripod to stabilize the camera, set this feature to Off to prevent this feature from malfunctioning. 	 73
AF assist	When set to Auto (default setting), the AF-assist illuminator ( 30) lights if shooting in dark surroundings to help the camera focus. <ul style="list-style-type: none"> Even if Auto is selected, the AF-assist illuminator may not light depending on the position of the focus area or the scene mode that is selected. 	 74
ISO sensitivity step value	Change the step value of the sensitivity to be set for ISO sensitivity of the quick menu. The default setting is 1 step .	 74
Digital zoom	When set to On (default setting), rotating and holding the zoom control toward T () triggers the digital zoom ( 29) if the optical zoom is at the maximum telephoto zoom position. When set to Crop , the digital zoom is limited to the range (to the zoom position ) at which image quality of the shot still picture does not deteriorate. <ul style="list-style-type: none"> The digital zoom cannot be used simultaneously in certain settings such as the shooting mode. 	 75
Zoom speed	Set the zoom operation speed. When set to Auto (default setting), zoom operates at Normal speed during still picture shooting. Zoom operates at Quiet speed (slower than normal speed) during movie recording.	 76
Fixed aperture	When set to On in A or M shooting mode, zoom operates while keeping changes in the aperture value to a minimum. The default setting is Off .	 76
Sound settings	Turn various camera sounds on and off. In the default setting, beep sounds are on. <ul style="list-style-type: none"> The operation sound is disabled in certain settings such as shooting mode. 	 77
Record orientation	When set to Auto (default setting), the orientation data is recorded with the picture taken.	 77
Rotate tall	When set to On (default setting), the images are rotated automatically in accordance with the camera's vertical orientation when they are played back.	 78
Auto off	Set the amount of time that passes before the monitor is turned off to save power. The default setting is 1 min .	 78

The Setup Menu

Option	Description	
Format memory/ Format card	Format the internal memory (only when a memory card is not inserted) or the memory card (when a memory card is inserted). <ul style="list-style-type: none"> • All data stored in the internal memory or on the memory card is deleted during formatting and cannot be restored. Be sure to transfer important images to a computer and save them before formatting. 	 79
Language	Change the camera's display language.	 79
TV settings	Adjust settings for connection to television. <ul style="list-style-type: none"> • When the camera is connected to a television using an audio/video cable but no picture is displayed on the television, set Video mode to NTSC or PAL according to the type of signal compatible with the television. • HDMI settings can be set. 	 80
External mic sensitivity	The external microphone sensitivity is set to Auto (default setting), High , Medium or Low .	 80
Customize command dials	Swap the function of the main command dial for that of the sub-command dial when the exposure is set ( 48). The default setting is No swap . <ul style="list-style-type: none"> • This option is available only when the shooting mode is P, S, A, M, U1, U2 or U3. 	 81
Command dial rotation	Change the direction of operation when the command dial is rotated during shooting. The default setting is Standard rotation . <ul style="list-style-type: none"> • This option is available when the shooting mode is P, S, A, M, U1, U2 or U3. 	 81
Multi selector right press	When set to AF area mode (default setting), the AF area mode setting ( 71) is displayed if the multi selector  () is pressed during shooting. In order not to display the AF area mode setting even if  () is pressed, set to Off .	 81
Delete button options	When set to Press twice to delete , the image can be deleted by pressing the  button again while the delete confirmation message is displayed. The default setting is Disable second press .	 82

Option	Description	
AE/AF lock button	Select the function to be performed when the AE-L/AF-L (AE-L/AF-L) button is pressed during shooting. When set to AE/AF lock button (default setting), both focus and exposure are locked if the AE-L/AF-L (AE-L/AF-L) button is pressed while shooting. <ul style="list-style-type: none"> When the scene mode is Scene auto selector (36), AF-L (AF lock) using the AE-L/AF-L (AE-L/AF-L) button is disabled. 	 82
Fn1 + shutter button	Set the function to be performed when the shutter-release button is pressed while pressing the Fn1 (function 1) button during shooting. The default setting is Off . <ul style="list-style-type: none"> This option is available when the shooting mode is P, S, A, M, U1, U2 or U3. 	 83
Fn1 + command dial	Set the function to be performed when the command dial is rotated while pressing the Fn1 (function 1) button during shooting. The default setting is Off . <ul style="list-style-type: none"> This option is available when the shooting mode is P, S, A, M, U1, U2, U3 or movie custom setting mode. 	 84
Fn1 + selector dial	Set the function to be performed when the multi selector is rotated while pressing the Fn1 (function 1) button during shooting. The default setting is Off . <ul style="list-style-type: none"> This option is available when the shooting mode is P, S, A, M, U1, U2, U3 or movie custom setting mode. 	 84
Fn1 guide display	When set to On (default setting), if the Fn1 (function 1) button is pressed during shooting, a guide for the functions assigned to the Fn1 + shutter button , Fn1 + command dial and Fn1 + selector dial is displayed on the monitor screen. <ul style="list-style-type: none"> In the shooting modes or settings during which the Fn1 button cannot be used,  will be displayed. 	 85
Fn2 button	Set the operation to be performed when the Fn2 (function 2) button is pressed during shooting. The default setting is Off .	 85
Customize My Menu	Register frequently used menu items in My Menu ( 68) (maximum of 5).	 86
Reset file numbering	When Yes is selected, the sequential numbering of file numbers is reset. After resetting, a new folder is created and the file number for the next image taken starts from "0001."	 87

The Setup Menu

Option	Description	
GPS options	<p>Set this option when the GPS Unit (available separately) is connected.</p> <p>Record GPS data: When set to On (default setting), signals are received from the GPS satellites and positioning starts. The position information (latitude and longitude) can be recorded on the pictures to be shot.</p> <p>Synchronize: Signals from the GPS satellites are used to set the date and time of the camera's internal clock (only when Record GPS data is set to On).</p>	 87
Eye-Fi upload	Set whether or not to enable the function for sending images to a computer using a commercially available Eye-Fi card. The default setting is Enable .	 89
MF distance indicator units	Set the unit of distance for displaying at screen gauge, to either m (meter) (default setting) or ft (feet) when using manual focus.	 90
Reverse indicators	Set the exposure indicator to be displayed when shooting mode is M and +/- display direction of indicator for setting the bracketing.	 90
Flash control	When Auto (default setting) is set, the optional Speedlight (external flash unit) will fire when it is used. When the Speedlight is not used, the built-in flash will fire.	 90
Reset all	<p>Reset the camera's settings to their default values.</p> <ul style="list-style-type: none"> Some of the settings such as Time zone and date and Language and user settings that were saved for mode dial U1, U2 and U3 are not reset. 	 91
Firmware version	Display the current camera firmware version.	 94



Reference Section

The Reference Section provides detailed information and hints for using the camera.

Shooting

Taking Pictures With Manual Focus.....		02
Using Easy Panorama (Shooting and Playing back)		03
Using Panorama Assist		06

Playback

Playing Images in a Sequence		08
Editing Still Images		10
Connecting the Camera to a TV (Viewing Images on a TV).....		19
Connecting the Camera to a Printer (Direct Print)		21

Movies

Editing Movies		26
----------------------	--	----

Menu

Quick Menu		28
Shooting Menu (P, S, A or M Mode)		42
Specialized Menu for U1, U2 or U3.....		58
Movie and Movie Custom Setting Menus		58
The Playback Menu.....		60
The Setup Menu.....		68

Additional Information

Error Messages		95
File and Folder Names		100
Optional Accessories.....		102
Shooting with Remote Control ML-L3		104

Taking Pictures With Manual Focus

Available when the shooting mode is **P**, **S**, **A**, **M**, **U1**, **U2**, **U3**, special effects mode, **Sports** scene mode, movie mode or movie custom setting mode.

1 Press the multi selector ▼ (MF focus mode).

- Use the multi selector to choose **MF** (manual focus) and press the **OK** button.
- **MF** is displayed on the top of the monitor, and the image area and the enlarged center of the picture are displayed at the same time.

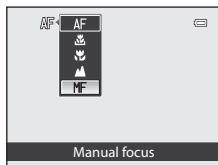
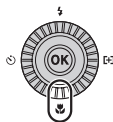

2 Adjust the focus.

- Use the multi selector to adjust the focus while viewing the image on the monitor screen.
- Press ▲ to focus on far subjects.
- Press ▼ to focus on near subjects.
- The focus can be adjusted in higher detail by rotating the multi selector than pressing ▲▼.
- When ► is pressed, first the camera is focused with autofocus, and then the manual focus can be operated. Choose **Yes** and press the **OK** button to focus on the subject in the center of the frame with autofocus.
- Press the shutter-release button halfway to check the composition. Press the shutter-release button all the way to take the picture.

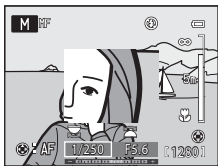

3 Press the **OK** button.

- The set focus is locked.
- Press the shutter-release button all the way to take the picture.
- To readjust the focus, press the **OK** button again to display the screen in step 2.
- To change back to autofocus, return to step 1 and choose any setting other than **MF**.

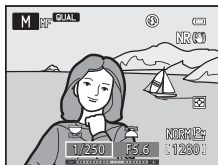



MF (Manual Focus)

- The digits displayed for the gauge on the right of the monitor in step 2 serve as a guideline for the distance to a subject that is in focus when the gauge indicates the center. To change the unit of this gauge, use **MF distance indicator units** (0-90) in the setup menu. The actual range at which the subject can be in focus varies depending on the aperture value and zoom position. To see whether the subject is in focus, check the subject on the monitor.
- Press the shutter-release button halfway to preview an approximate depth of field (the area in focus behind and in front of the subject).
- The digital zoom is not available.



Using Easy Panorama (Shooting and Playing back)

Taking Pictures with Easy Panorama

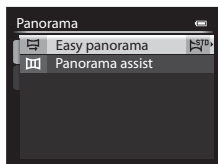

Rotate the mode dial to SCENE → MENU button →  Panorama

- 1 Select  **Easy panorama** and press the  button.



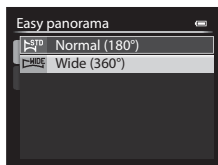

- 2 Select the shooting range from  **Normal (180°)** or  **Wide (360°)**, and press the  button.



- The image sizes (W × H) when the camera is held in landscape orientation are as follows.
 -  **Normal (180°)**:
3200 × 560 when the camera is moved horizontally,
1024 × 3200 when the camera is moved vertically
 -  **Wide (360°)**:
6400 × 560 when the camera is moved horizontally,
1024 × 6400 when the camera is moved vertically
- For the image sizes when the camera is held in “tall” orientation, the combinations of the moving direction and W × H are the opposites of the above.

- 3 Frame the first portion of the panorama scene, and press the shutter-release button halfway to adjust the focus.

- The zoom is fixed at the wide-angle position.
- The framing guide is displayed on the monitor.
- The camera focuses on the subject at the center of the frame.
- Exposure compensation (66) can be adjusted.
- If the focus or exposure cannot be set for the main subject, try the focus lock (86).

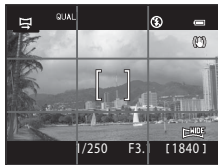

4 Press the shutter-release button all the way, and release it.

- The  icons showing the panorama direction are displayed.





5 Move the camera straight and slowly in one of the four directions to start shooting.

- When the camera detects the panorama direction, the shooting starts.
- The guide showing the current shooting point is displayed.
- When the guide showing the shooting point reaches the end, the shooting ends.



Guide

Example of Moving the Camera

- The user, without shifting position, moves the camera, from end to end of the guide, horizontally or vertically in an arc.
- If about 15 seconds (in  **Normal (180°)**) or 30 seconds (in  **Wide (360°)**) pass from the start of the shooting, and before the guide showing the shooting point reaches the end, the shooting ends.

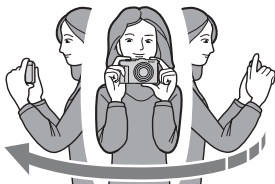

Notes on Easy Panorama Shooting

- The image area seen in the saved image will be narrower than that seen on the monitor at the time of shooting.
- When the camera movement speed is too fast, there is a large amount of camera shake or there is little change in subject such as wall or in the dark, the shooting ends in an error.
- Panorama pictures are not saved when the shooting stops before reaching half of the panorama range.
- When the shooting reaches more than half of the panorama range but finishes before the end point, the range that is not shot will be recorded as a gray area.

Viewing Easy Panorama (Scroll)

Switch to playback mode (32), display the picture recorded with Easy panorama in full-frame playback mode and press the **OK** button. The camera displays the short side of the picture filling the entire screen and scrolls the displayed area automatically.

- **STD** or **WIDE** is displayed for pictures recorded with Easy panorama.
- The picture is scrolled in the direction of the panorama shooting.
- Rotate the multi selector to advance or rewind.

Playback controls are displayed at the top of the monitor during playback. When you choose a playback control with the multi selector ◀ or ▶ and press the **OK** button, the following operations can be performed.



To	Use	Description	
Rewind	◀◀	Scroll quickly back while the OK button is pressed.*	
Advance	▶▶	Scroll quickly forward while the OK button is pressed.*	
Pause		The following operations can be performed with the playback controls at the top of the monitor while playback is paused.	
		◀	Rewind while the OK button is pressed.*
		▶	Scroll while the OK button is pressed.*
End	■	▶	Restart the automatic scroll.
			Return to full-frame playback mode.

* These operations can also be performed by rotating the multi selector.

✔ Note on Viewing Pictures Recorded with Easy Panorama

Panorama pictures recorded with functions other than Easy panorama of the COOLPIX P7700 may not be scrolled or zoomed on this camera.

Using Panorama Assist

Using a tripod makes the composition easier. When using a tripod to stabilize the camera, set **Vibration reduction** (🔗73) to **Off** in the setup menu.

Rotate the mode dial to **SCENE** → **MENU** button → 📷 Panorama

1 Select 📷 Panorama assist and press the OK button.

- The 📷 icon is displayed to show the direction in which pictures are joined.

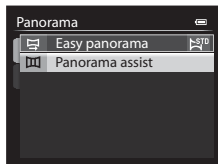

2 Use the multi selector to choose the direction, and press the OK button.

- Select the direction in which pictures are joined in the completed panorama: right (➡), left (⬅), up (⬆) or down (⬇).
- The yellow icon (➡➡) moves to the selected direction, so press the OK button to select the direction. A white icon (➡) is displayed in the selected direction.
- Apply flash mode (📖56), self-timer (📖59)/remote control (🔗104), focus mode (📖62) and exposure compensation (📖66) settings with this step, if necessary.
- Press the OK button again to reselect the direction.



3 Frame the first portion of the panorama scene, and take the first picture.

- The camera focuses on the subject at the center of the frame.
- 1/3 of the image will be displayed as translucent.



4 Shoot the next picture.

- Match the outline of the next picture so that 1/3 of the frame overlaps the previous picture, and press the shutter-release button.
- Repeat until you have taken the necessary number of pictures to complete the image.



5 Press the **OK** button when shooting is completed.

- The camera returns to step 2.

Notes on Panorama Assist

- Set the flash mode, self-timer/remote control, focus mode and exposure compensation before releasing the shutter for the first picture. The settings cannot be changed after shooting the first picture. Pictures cannot be deleted, nor can zoom, **Image quality** (📖75), or **Image size** (📖77) be adjusted after shooting the first picture.
- The panorama series is terminated if the auto off function (🔌78) triggers the standby mode during shooting. To prevent this, setting a longer time for the auto off function is recommended.

AE/AF-L (Exposure Lock) Indicator

When using panorama assist mode, all pictures in the panorama have the same exposure, white balance, and focus as the first picture of the panorama.

When the first picture is shot, **AE/AF-L** is displayed on the monitor to indicate that exposure, white balance, and focus are locked.



Panorama Creation with Panorama Maker

Transfer pictures to a computer (📖99) and use Panorama Maker to join them in a single panorama.

- Panorama Maker can be installed on a computer using the included ViewNX 2 CD-ROM (📖97).
- For more information on using Panorama Maker, refer to the on-screen instructions and help information contained in Panorama Maker.

More Information

See "File and Folder Names" (🔌100) for more information.

Playing Images in a Sequence

The images shot in the following continuous shooting mode are saved as a group (called a “sequence”) each time you shoot.

- **Continuous H, Continuous M, Continuous L, Continuous H: 120 fps** or **Continuous H: 60 fps** in **Continuous** (📷44) in the shooting menu
- **Sports** (📖37) or **Continuous** in the **Pet portrait** (📖42) scene mode

In full-frame playback mode or thumbnail playback mode (📖92), the first image of a sequence is used as the “key picture”, i.e., it is displayed to represent the images in the sequence.

Sequence display



While the key picture of a sequence is displayed in full-frame playback mode, press the **OK** button to display each image in the sequence individually. To return to key picture only display, press the multi selector **▲**.

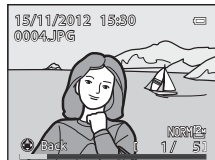

The following operations can be performed when each image in a sequence is displayed individually.

- Select an image: Rotate the multi selector or press **◀** or **▶**.
- Zoom in: Rotate the zoom control toward **T** (📷) (📖91).

✔ Note on Sequence

Pictures captured continuously with cameras other than COOLPIX P7700 cannot be displayed as a sequence.

📌 Sequence Display Options

Select **Sequence display options** (📷67) in the playback menu to set all sequences to be displayed using their key pictures or to display them as individual images.

If an image in the sequence is selected when **Sequence display options** is set to **Individual pictures**, 📷 icon is displayed on the monitor.

📌 Changing Key Picture in Sequence

A sequence’s key picture can be changed using **Choose key picture** (📷67) in the playback menu.

Deleting Images in a Sequence

When **Sequence display options** (👁️67) is set to **Key picture only** in the playback menu, the 🗑️ button can be pressed to delete the following images.

- When a sequence is displayed by its key picture only:
When the sequence is selected, all images in the sequence are deleted.
- If the key picture is selected and the OK button is pressed to display individual images in the sequence before pressing the 🗑️ button:
Delete the image that is displayed.

When **Delete** (👁️63) of the playback menu is used, multiple images can be deleted or multiple images in the same sequence can be selected and deleted.

Playback Menu Options Available When Using Sequence

When the **MENU** button is pressed during an image sequence playback, the following menu operations are available.

- | | | | |
|-------------------------------|--------|-------------------------------------|--------|
| • Quick retouch ¹ | → 👁️12 | • Small picture ¹ | → 👁️15 |
| • D-Lighting ¹ | → 👁️12 | • Voice memo ¹ | → 👁️65 |
| • Skin softening ¹ | → 👁️13 | • Copy ² | → 👁️66 |
| • Filter effects ¹ | → 👁️14 | • Black border ¹ | → 👁️15 |
| • Print order ² | → 👁️60 | • Straighten ¹ | → 👁️16 |
| • Slide show | → 👁️62 | • NRW (RAW) processing ¹ | → 👁️16 |
| • Delete ² | → 👁️63 | • Sequence display options | → 👁️67 |
| • Protect ² | → 👁️64 | • Choose key picture | → 👁️67 |
| • Rotate image ¹ | → 👁️64 | | |

¹ Press the **MENU** button after displaying individual images. Settings can be applied to individual images.

² When the **MENU** button is pressed during displaying only the key picture, the same settings can be applied to all images in that sequence. Press the **MENU** button after displaying individual images to apply settings to individual images.

Editing Still Images

Editing Features

Images can be easily edited with this camera using the functions below. Edited images are stored as separate files (📷100).

Editing function	Application
Quick retouch (📷12)	Easily create a copy with enhanced contrast and richer colors.
D-Lighting (📷12)	Create a copy of the current picture with enhanced brightness and contrast, brightening dark portions of the picture.
Skin softening (📷13)	Make the facial skin tones softer.
Filter effects (📷14)	Apply a variety of effects using digital filter. The available effects are Soft , Selective color , Cross screen , Fisheye , Miniature effect , Painting and Vignette .
Small picture (📷15)	Create a small copy of pictures suitable for uses such as e-mail attachments.
Black border (📷15)	Add a black frame around the picture. Use when you want to add a black border to a picture.
Straighten (📷16)	Compensate for the slanting.
NRW (RAW) processing (📷16)	Create JPEG-format copies by performing RAW processing within the camera for NRW (RAW) images (📷75) without having to use a computer.
Crop (📷18)	Crop a portion of the picture. Use to zoom in on a subject or arrange a composition.

Original Pictures and Edited Copies

- Copies created with editing functions are not deleted if the original pictures are deleted. The original pictures are not deleted if copies created with editing functions are deleted.
- Edited copies are stored with the same shooting date and time as the original.
- Even if the pictures that are marked for **Print order** (📷60) or **Protect** (📷64) are used for editing, these settings are not reflected on the edited copies.

More Information

See "File and Folder Names" (📷100) for more information.

✓ Notes on Image Editing

- The following pictures cannot be edited.
 - Pictures taken using an aspect ratio of 16:9, 3:2 or 1:1 (except when using the black border editing function)
 - Pictures taken using **Easy panorama** or **3D photography**
 - Pictures taken with cameras other than COOLPIX P7700
- When no faces are detected in the picture, skin softening cannot be applied (👤13).
- Editing other than NRW (RAW) processing cannot be performed on NRW (RAW) images. Edit a JPEG image created with NRW (RAW) processing.
- If a copy created using the COOLPIX P7700 is viewed on a different digital camera, it may not be possible to display the picture properly or transfer it to a computer.
- Editing functions are not available when there is not enough free space in the internal memory or on the memory card.
- For a sequence displayed using the key picture only setting (👤8), perform one of the following operations before editing.
 - Press the 📄 button to display individual images, and then select an image in the sequence.
 - Set **Sequence display options** (👤67) to **Individual pictures** so that each image is displayed individually, and then select an image.

📄 Restrictions on Image Editing

The following restrictions apply when editing pictures that were created by editing.

Editing functions used	Editing functions to add
Quick retouch D-Lighting	Skin softening, Filter effects, Small picture, Black border, Straighten or Crop can be used. Quick retouch and D-Lighting cannot be used in combination with each other.
Skin softening Straighten NRW (RAW) processing	Additional editing functions can be used.
Filter effects	Quick retouch, D-Lighting, Skin softening, Small picture, Black border, Straighten or Crop can be used.
Small picture	No additional editing functions can be used.
Black border	Small picture can be used.
Crop	Black border or Straighten can be used. Picture editing is not available when the image size is reduced to 320 × 240 or 160 × 120.

- Copies created by editing cannot be edited again using the same editing function.
- To use an editing function together with small picture, use the other editing function first, and use small picture as the last editing function performed on that picture.
- Pictures that were taken using skin softening can be edited using skin softening.
- Pictures that were extracted from a movie cannot be edited using the quick retouch or skin softening function.

Quick Retouch: Enhancing Contrast and Saturation

Select a picture (📖32) → MENU button (📖10) →  Quick retouch

Press the multi selector ▲ or ▼ to choose the setting level, and press the  button.

- The original version is displayed on the left and the edited version is displayed on the right.
- To cancel, press ◀.
- Quick retouched copies are stored as separate files and recognized by the  icon displayed in playback mode (📖14).

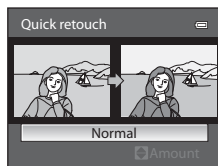

D-Lighting: Enhancing Brightness and Contrast



Select a picture (📖32) → MENU button (📖10) →  D-Lighting

Press the multi selector ▲ or ▼ to choose the setting level, and press the  button.

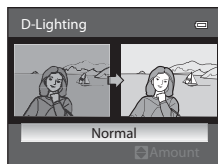
- The original version is displayed on the left and the edited version is displayed on the right.
- To cancel, press ◀.
- D-Lighting copies are stored as separate files and recognized by the  icon displayed in playback mode (📖14).



Skin Softening: Softening Skin Tones



Select a picture (32) → MENU button (10) →  Skin softening

1 Press the multi selector ▲ or ▼ to choose the setting level, and press the button.

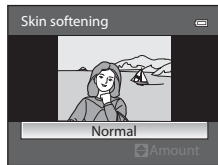
- A confirmation screen is displayed, and the image is displayed zoomed in on the face edited by skin softening.
- To cancel, press ◀.



2 Confirm the results and press the button.

- Up to 12 faces, in order of proximity to the center of the frame, can be enhanced.
- When multiple faces are edited using skin softening, use the multi selector ◀ or ▶ to switch the face that is displayed.
- To adjust the extent of skin softening, press the **MENU** button and return to step 1.
- Copies created by editing with skin softening are stored as separate files and recognized by the  icon displayed in playback mode (14).



Notes on Skin Softening

- Depending on conditions such as the direction the subject is facing or the brightness of the face, the face may not be detected properly, or the desired effect may not be achieved.
- If no faces are detected in the image, a warning is displayed and the screen returns to the playback menu.

Filter Effects: Applying Digital Filter Effects

Select a picture (📖32) → MENU button (📖10) → 🎛️ Filter effects

Option	Description
Soft	Gently soften the focus of the image from the center to the edge. In pictures taken with face detection (📖85) or pet detection (📖42) selected, areas around faces will be blurred.
Selective color	Keep only selected image colors and makes other colors black-and-white.
Cross screen	Produce star-like rays of light that radiate outward from bright objects such as sunlight reflections and city lights. Suitable for night scenes.
Fisheye	Create images that look like they were shot with a fisheye lens. Suitable for pictures shot in macro mode.
Miniature effect	Create images that look like close-up photos of a diorama. Suitable for pictures shot while looking down from a high location, with the main subject near the center of the frame.
Painting	Create images with the ambience of paintings.
Vignette	Create images by lowering the peripheral light intensity from the center to the edges of an image.

1 Press the multi selector ▲ or ▼ to choose the filter effect type and press the **OK** button.

- When **Cross screen**, **Fisheye**, **Miniature effect**, **Painting** or **Vignette** is selected, proceed to step 3.

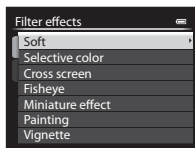

2 Adjust the effect and press the **OK** button.

- **Soft:** Press ▲ or ▼ to choose the extent of the effect.
- **Selective color:** Press ▲ or ▼ to select the color to keep.

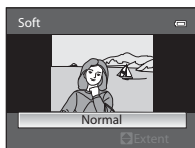



Soft

3 Check the effect and press the **OK** button.

- To cancel, press ⏪.
- Copies created by editing with filter effect are stored as separate files and recognized by the 🎛️ icon displayed in playback mode (📖14).





Small Picture: Reducing the Size of an Image

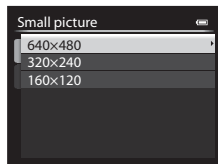

Select a picture (32) → MENU button (10) →  Small picture

- 1 Press the multi selector ▲ or ▼ to choose the desired copy size and press the  button.

- The available size is **640×480**, **320×240** or **160×120**.





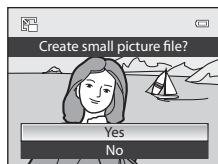

- 2 Choose **Yes** and press the  button.

- The created copies are stored as separate files (compression rate of about 1:16).
- Images created using small picture are displayed as small images in playback mode and  is displayed (14).





Black Border: Adding a Black Border to Pictures

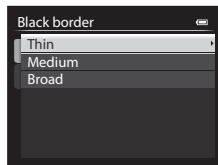

Select a picture (32) → MENU button (10) →  Black border

- 1 Press the multi selector ▲ or ▼ to choose the desired frame thickness and press the  button.

- Choose from **Thin**, **Medium**, or **Broad** lines.



- 2 Choose **Yes** and press the  button.

- Copies created by editing with black borders are saved as separate files and are recognized by the  icon displayed in playback mode (14).

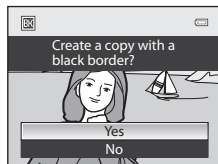

Notes on Black Border

- A part of the picture equivalent to the thickness of the black border is cut off because the black border overlaps the picture.
- When a picture with a black border is printed using a printer's borderless print function, the black border may not be printed.

🔧 Straighten: Compensating for Picture Slanting

Select a picture (📖32) → MENU button (📖10) → 🔧 Straighten

1 Use the multi selector to compensate for slanting.

- Press ◀ to rotate counterclockwise by 1 degree.
- Press ▶ to rotate clockwise by 1 degree.
- To cancel, press the MENU button.

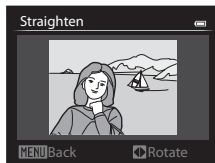

2 Press the OK button.

- Copies created by editing with straighten are stored as separate files and recognized by the 🔧 icon displayed in playback mode (📖14).

✔ Notes on Straighten

- When straighten is performed, the picture edges are cut. The larger the slant for which compensation is performed, the larger the area around the picture that is cut.
- Straighten can be performed up to 15 degrees.

NRW NRW (RAW) Processing: Creating JPEG Images from NRW Images

Press the MENU button (📖10) → NRW NRW (RAW) processing

1 Use the multi selector to choose the picture to be RAW processed and press the OK button.

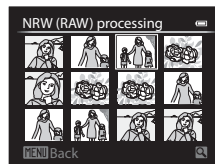

2 Set the NRW (RAW) processing parameters.

- Apply the settings below while checking the image and rotating the zoom control toward **T** (Q). Rotate toward **T** (Q) again to return to the setting screen.
 - White balance:** Adjust the white balance setting (👁️33).
 - Exp. +/-:** Adjust the brightness.
 - Picture Control:** Change the settings for finish of the image (👁️38).
 - Image quality:** Set the image quality to **Fine** or **Normal** (📖75).
 - Image size:** Choose an image size (📖77). The image is cropped if **3984×2656**, **3968×2232** or **3000×3000** is selected.
 - Distortion control:** Set the distortion control (👁️53).
 - D-Lighting:** Enhance brightness and contrast in dark portions of pictures (👁️12).
- Press the  button to change back to the default settings.
- Choose **EXE** when all settings have been adjusted.

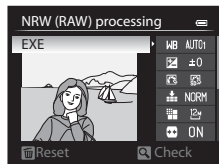

3 Choose **Yes** and press the **OK** button.

- An NRW (RAW) processed JPEG image is created.

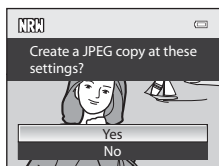

Notes on NRW (RAW) Processing

- The COOLPIX P7700 can only create JPEG-format copies of NRW (RAW) images taken with the COOLPIX P7700.
- NRW (RAW) processing > **White balance** > **Preset manual** cannot be selected for photographs taken at a **White balance** setting other than **Preset manual**.
- The **Noise reduction filter** (👁️52) that was set for shooting a picture is applied to the JPEG images to be created.

More Information

See "Printing Images of Size 1:1" (📖78) for more information.

✂ Crop: Creating a Cropped Copy

Create a copy containing only the portion visible on the monitor screen when **MENU** ✂ is displayed with playback zoom (📖91) enabled.

1 Enlarge the picture for cropping (📖91).

2 Refine copy composition.

- Rotate the zoom control toward **T** (📐) or **W** (📐) to adjust the zoom ratio.
- Press the multi selector ▲, ▼, ◀ or ▶ to scroll the picture until only the portion you want to copy is visible on the monitor.



3 Press the **MENU** button.

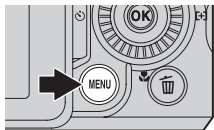

4 Use the multi selector to choose **Yes** and press the **OK** button.

- Cropped copies are stored as separate files and recognized by the ✂ icon displayed in playback mode (📖14).

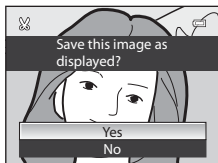

✂ Image Size

The narrower the cropping range, the smaller the size (amount of pixels) of the cropped picture copy. When the image size setting for a cropped copy is 320 × 240 or 160 × 120, a small image is displayed in playback mode.

✂ Cropping the Picture in its Current “Tall” Orientation

Use the **Rotate image** option (📐64) to rotate the picture so that it is displayed in landscape orientation. After cropping the picture, rotate the cropped picture back to “tall” orientation. The picture displayed in “tall” orientation can be cropped by zooming in on the picture until the black bars displayed on the both sides of the monitor disappear. The cropped picture is displayed in landscape orientation.

Connecting the Camera to a TV (Viewing Images on a TV)

Connect the camera to a television to play back pictures on the television. If your television is equipped with an HDMI connector, you can connect it to the camera with a commercially available HDMI cable to play back pictures.

1 Turn off the camera.

2 Connect the camera to the TV.

When connecting using the included audio/video cable

- Connect the yellow plug to the video-in jack on the TV, and the red and white plugs to the audio-in jacks.

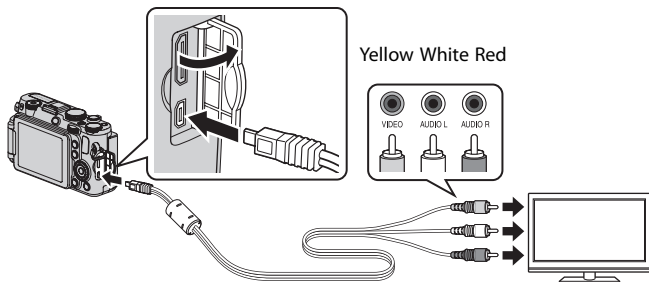

When connecting using a commercially available HDMI cable

- Connect the plug to the HDMI input connector on the TV.

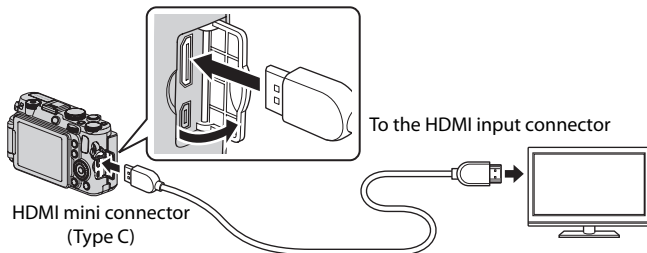

3 Tune the television to the video channel.

- See the instruction manual provided with your TV for details.

4 Open the monitor and hold down the button to turn on the camera.

- The camera enters playback mode, and the recorded pictures are displayed on the TV.
- While the camera is connected to the TV, the monitor remains off.

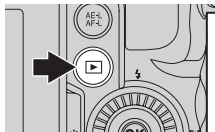

Note on Connecting an HDMI Cable

An HDMI cable is not included. Use a commercially available HDMI cable to connect the camera to a TV. The output terminal on this camera is a HDMI Mini Connector (Type C). When purchasing an HDMI cable, be sure that the device end of the cable is a HDMI Mini Connector.

Notes on Connecting the Cable

- When connecting the cable, be sure that the plug is oriented correctly. Do not force the plug into the camera. When disconnecting the cable, do not pull the plug at an angle.
- Do not connect cables to the HDMI mini connector and USB/Audio video connector simultaneously.

When Nothing Appears on the TV

Make sure that **TV settings** (080) in the setup menu is appropriate for your television.

Using the TV's Remote Control (HDMI Device Control)

The remote control of a TV that conforms to the HDMI-CEC standard can be used to operate the camera during playback.

Instead of the multi selector or zoom control, the remote control can be used for picture selection, playback/pause of movies, switching between full-frame playback and 4-picture thumbnail display, etc.

- Set **HDMI device control** (080) of **TV settings** to **On** (default setting) in the setup menu, and connect the camera to the TV with an HDMI cable.
- Point the remote control at the TV to operate.
- See your TV's instruction manual or other related documentation to check whether your TV conforms to the HDMI-CEC standard.

HDMI and HDMI-CEC

"HDMI" is an abbreviation of High-Definition Multimedia Interface, which is one type of multimedia interface.

"HDMI-CEC" is an abbreviation of HDMI-Consumer Electronics Control, which enables operations to be linked between compatible devices.

Connecting the Camera to a Printer (Direct Print)

Users of PictBridge-compatible (🔌17) printers can connect the camera directly to the printer and print pictures without using a computer.

Connecting the Camera to a Printer

- 1 Turn off the camera.
- 2 Turn on the printer.
 - Check the printer settings.
- 3 Connect the camera to the printer using the included USB cable.
 - Be sure that the plug is oriented correctly. When disconnecting the cable, do not pull the plug at an angle.

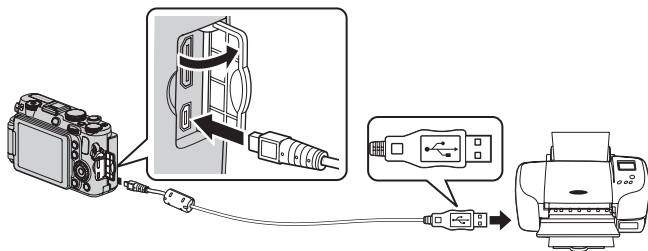

- 4 The camera is automatically turned on.
 - When connected correctly, the **PictBridge** startup screen (①) is displayed on the monitor screen of the camera. Then the **Print selection** screen (②) is displayed.



✓ Notes on Power Source

- When connecting the camera to a printer, use a fully charged battery to prevent the camera from turning off unexpectedly.
- If the AC Adapter EH-5b and the Power Connector EP-5A (available separately) (🔌103) are used, COOLPIX P7700 can be powered from an electrical outlet. Do not, under any circumstances, use an AC Adapter other than the EH-5b or a Power Connector other than the EP-5A. Failure to observe this precaution could result in overheating or damage to the camera.

Printing Individual Images

After connecting the camera to the printer correctly (📷21), print pictures by following the procedure below.

1 Use the multi selector to choose the picture to be printed, and press the **OK** button.

- Rotate the zoom control toward **W** (📷) to display 12 thumbnails, or toward **T** (📷) to switch back to full-frame playback mode.

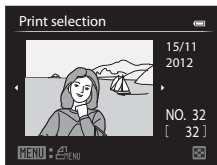

2 Set the number of copies and paper size.

- Choose **Copies** and press the **OK** button to set the number of copies (up to 9).
- Choose **Paper size** and press the **OK** button to set the paper size (📷25).
To prioritize the printer settings, select **Default**.

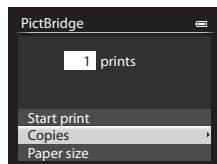

3 Choose **Start print** and press the **OK** button.

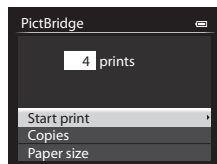

4 Printing starts.

- The monitor display returns to that shown in step 1 when printing is complete.
- When printing is complete, turn the camera off and then disconnect the USB cable.

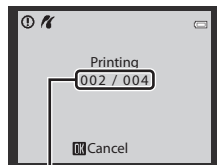

Current print/total number of prints

Printing Multiple Images

After connecting the camera to the printer correctly (📷21), print pictures by following the procedure below.

- 1 When the **Print selection** screen is displayed, press the **MENU** button.

- To exit the print menu, press the **MENU** button.

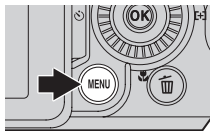

- 2 Choose **Print selection**, **Print all images** or **DPOF printing** and press the **OK** button.

- Choose **Paper size** and press the **OK** button to set the paper size (📷25).
To prioritize the printer settings, select **Default**.

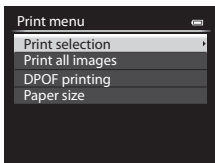

Print selection

Choose the pictures (up to a maximum of 99) and number of copies (up to 9 per picture).

- Press the multi selector ◀ or ▶ to choose the pictures, and press ▲ or ▼ to set the number of copies for each.
- Pictures selected for printing can be recognized by the check mark icon and the numeral indicating the number of copies to be printed. If the numeral is set to 0, the print selection is cancelled.
- Rotate the zoom control toward **T** (📷) to switch to full-frame playback mode, or **W** (📷) to switch to 12 thumbnail display.
- Press the **OK** button when setting is complete.
- When the menu shown on the right is displayed, choose **Start print** and press the **OK** button to start printing.

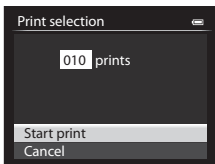

Print all images

All pictures stored in the internal memory or on the memory card are printed one per each.

- When the menu shown on the right is displayed, choose **Start print** and press the **OK** button to start printing.

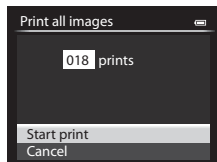

DPOF printing

Pictures for which a print order was created in **Print order** option (060) can be printed.

- When the menu shown on the right is displayed, choose **Start print** and press the **OK** button to start printing.

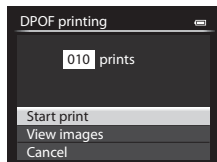

- To view the current print order, choose **View images** and press the **OK** button. To print pictures, press the **OK** button again.



3 Printing starts.

- The monitor display returns to that shown in step 2 when printing is complete.

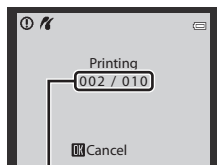

Current print/total number of prints

 **More Information**

See "Printing Images of Size 1:1" (📖78) for more information.

 **Paper Size**

The camera supports the following paper sizes: **Default** (the default paper size for the current printer), **3.5×5 in.**, **5×7 in.**, **100×150 mm**, **4×6 in.**, **8×10 in.**, **Letter**, **A3**, and **A4**. Only sizes supported by the current printer are displayed.

 **Printing Pictures**

In addition to printing pictures transferred to a computer and printing pictures with a direct camera-to-printer connection, the following options are also available for printing pictures recorded on the memory card:

- Insert a memory card into a DPOF-compatible printer's card slot.
- Take a memory card to a digital photo lab.

For printing using these methods, specify the pictures and the number of prints each using the **Print order** (🔍60) option in the playback menu.

Editing Movies

Extracting Only the Desired Portions of the Movie

The desired portions of a recorded movie can be saved as a separate file.

1 Play back the movie to be edited and pause at the start point of the portion that is to be extracted (📖109).

2 Use the multi selector ◀ or ▶ to choose ✂ on the playback control, and press the Ⓞ button.

- The movie editing screen is displayed.

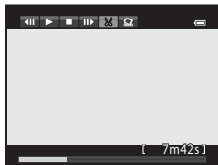

3 Press ▲ or ▼ to choose ⏮ (Choose start point) on the editing playback control.

- Rotate the multi selector or press ◀ or ▶ to adjust the start position.
- To cancel, press ▲ or ▼ to choose ⏪ (Back) and press the Ⓞ button.

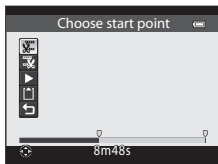

4 Press ▲ or ▼ to choose ⏭ (Choose end point).

- Rotate the multi selector or press ◀ or ▶ to move the end point at the right end to the end position of the required section.
- To check the playback of the movie in the specified range before saving it, choose ▶ (Preview) and press the Ⓞ button. During preview playback, the volume can be adjusted with the zoom control T/W. Use the multi selector to fast forward or rewind. To stop the preview playback, press the Ⓞ button again.

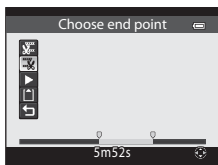

5 After finishing the settings, press ▲ or ▼ to choose 💾 (Save) and press the Ⓞ button.

6 Choose **Yes** and press the Ⓞ button.

- The edited movie is saved.

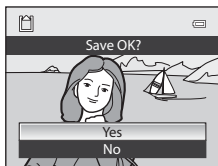

✔ Notes on Editing Movies





- Use a fully charged battery to prevent the camera from turning off during editing. When the battery level is , movie editing is not possible.
- Once a movie is created through editing, it cannot be used again for extracting a movie. To extract another range, select and edit the original movie.
- Because the edited movies are extracted in one-second units, they may vary slightly from the set start point and end point. Sections shorter than two seconds cannot be extracted.
- Editing functions are not available when there is not enough free space in the internal memory or on the memory card.

✎ More Information



See "File and Folder Names" (100) for more information.

Saving a Frame from a Movie as a Still Picture

A frame from a recorded movie can be extracted and saved as a still picture.

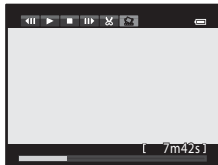
- Pause a movie and display the frame to be extracted (109).
- Choose  on the playback control with the multi selector  or  and press the  button.



- When the confirmation dialog is displayed, choose **Yes** and press the  button to save.
- The still picture is saved with **Normal** as the image quality. The image size is determined by the type (image size) (28) of the original movie.

For example, a still picture saved from a movie recorded with  **HD 1080p★ (1920×1080)** is  (1920 × 1080 pixels).

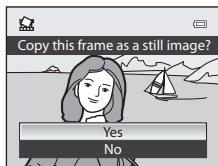

Quick Menu

QUAL Image Quality and Image Size

To set the image quality and image size, see “Changing the Image Quality and Image Size” (📖 75).

QUAL Movie Options





Rotate the mode dial to 📷 or 📷CSM → QUAL (Quick menu dial) (📖 69) → Movie options

You can select the type of movie to shoot.

The camera can record normal speed movies and HS (high speed) movies (📷 29), which can be played back in slow motion or fast motion.

The larger the image size and bit rate, the higher the image quality; however, the file size also becomes larger.

Normal Speed Movies

Option	Description
 HD 1080p★ (1920×1080) (default setting)	Movies with an aspect ratio of 16:9 are recorded. <ul style="list-style-type: none">• Movie bitrate: 18.8 Mbps• Frame rate: approx. 30 frames per second
 HD 1080p (1920×1080)	Movies with an aspect ratio of 16:9 are recorded. <ul style="list-style-type: none">• Movie bitrate: 12.6 Mbps• Frame rate: approx. 30 frames per second
 HD 720p (1280×720)	Movies with an aspect ratio of 16:9 are recorded. <ul style="list-style-type: none">• Movie bitrate: 8.4 Mbps• Frame rate: approx. 30 frames per second
 VGA (640×480)	Movies with an aspect ratio of 4:3 are recorded. <ul style="list-style-type: none">• Movie bitrate: 2.9 Mbps• Frame rate: approx. 30 frames per second

Note on Bit Rate



The movie bitrate is the volume of movie data recorded per second. As a variable bitrate (VBR) system has been adopted, the movie bitrate varies automatically according to the subject so that more data is recorded per second for movies containing frequently moving subjects, thus increasing movie file size.

Note on Movie Custom Setting Mode

 **VGA (640×480)** of normal speed movies and HS (high speed) movies cannot be selected.





HS Movie (Movie Mode Only)

See “Recording Movies in Slow Motion and Fast Motion (HS Movie)” (030) for more information.

Option	Description
 HS 120 fps (640×480)	1/4-speed slow motion movies with an aspect ratio of 4:3 are recorded. <ul style="list-style-type: none"> • Max. movie length: 7 min 15 s (playback time: 29 min) • Movie bitrate: 2.8 Mbps • Frame rate: approx. 120 frames per second
 HS 60 fps (1280×720)	1/2-speed slow motion movies with an aspect ratio of 16:9 are recorded. <ul style="list-style-type: none"> • Max. movie length: 14 min 30 s* (playback time: 29 min) • Movie bitrate: 8.3 Mbps • Frame rate: approx. 60 frames per second
 HS 15 fps (1920×1080)	2x speed fast motion movies with an aspect ratio of 16:9 are recorded. <ul style="list-style-type: none"> • Max. movie length: 29 min (playback time: 14 min 30 s) • Movie bitrate: 18.6 Mbps • Frame rate: approx. 15 frames per second

* The maximum movie length for a single movie is 30 seconds when it is saved in the internal memory.

Maximum Movie Length

Movie options (028)	Memory card (4 GB) ²
 HD 1080p★ (1920×1080) ¹	25 min
 HD 1080p (1920×1080)	40 min
 HD 720p (1280×720)	1 h
 VGA (640×480)	3 h



After removing the memory card, check the indicator showing the number of exposures that can be stored in the internal memory (approx. 86 MB) on the screen during shooting. All figures are approximate. The maximum movie length varies with the make of the memory card and the bitrate of the recorded movie.

- ¹ When set to  HD 1080p★ (1920×1080) while using the internal memory, the maximum movie length for a single movie is 25 seconds.
- ² The maximum movie recording time (maximum movie length for a single movie) is 4 GB or 29 minutes, even when there is sufficient free space on the memory card. The maximum movie length for a single movie is displayed on the screen during movie recording. If the camera becomes hot, the movie recording may end within the maximum movie recording time.

More Information

See “File and Folder Names” (0100) for more information.

Recording Movies in Slow Motion and Fast Motion (HS Movie)

When **Movie options** in  (movie) mode is set to HS movie ()29, HS (high speed) movies can be recorded. Movies recorded using HS movie can be played back in slow motion at 1/4 or 1/2 of normal playback speed, or played back in fast motion at a speed two times faster than normal speed.

See “Recording Movies” ()101) for more information on recording movies.

Portions recorded at 120 HS 120 fps (640×480):

Movies are recorded for up to 7 minutes and 15 seconds at high speed, and are played back in slow motion at a speed four times slower than normal speed.

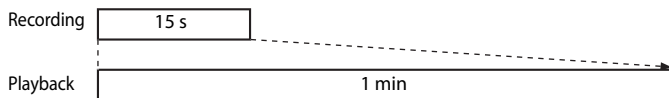

Portions recorded at 15 HS 15 fps (1920×1080):

A movie of up to 29 minutes in length is recorded when shooting for the purpose of fast motion playback. Movies are played back two times faster than normal speed.

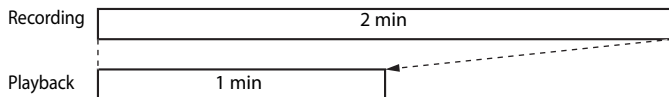

Notes on HS Movie

- The sound is not recorded.
- Zoom position, focus, exposure and white balance are locked when movie recording starts.

ISO Sensitivity

Rotate the mode dial to **P, S, A, M, U1, U2, U3** or **CSM** → **ISO** (Quick menu dial)
 (☰69) → ISO sensitivity

The higher the ISO sensitivity, the less light needed for taking pictures. The higher the ISO sensitivity, the darker the subject that can be shot. Additionally, even with subjects of similar brightness, pictures can be taken at faster shutter speeds, and blurring caused by camera shake and subject movement can be reduced.

- Setting the ISO sensitivity to a high level is effective when shooting dark subjects, not using the flash, shooting at the telephoto zoom position and similar situations, but the pictures taken may be slightly grainy.

Option	Description
ISO sensitivity	<ul style="list-style-type: none"> • Auto (default setting): The sensitivity is ISO 80 in bright places; in dark places the camera automatically raises the sensitivity to a maximum of ISO 1600. • ISO 200 ISO 80-200, ISO 400 ISO 80-400, ISO 800 ISO 80-800, (fixed range auto): Choose the range in which the camera automatically adjusts ISO sensitivity. The camera does not raise sensitivity beyond the maximum value in the selected range. Set the maximum value for ISO sensitivity to control "grain" that appears in images. • 80 to 3200, Hi 1 (equivalent to ISO 6400): ISO sensitivity is fixed at the specified value. The step value that can be set for ISO sensitivity step value of the setup menu can be changed (☰74).
Minimum shutter speed	When the shooting mode is P or A and ISO sensitivity is set to Auto, ISO 80-200, ISO 80-400 or ISO 80-800 , the shutter speed (1/30 to 1 second), at which automatic control of ISO sensitivity starts to function, is set. The default setting is None . If the exposure is insufficient with the shutter speed that is set here, the ISO sensitivity is increased automatically to obtain the correct exposure. If the exposure is still insufficient even after the ISO sensitivity is increased, the shutter speed slows down.

The icon for the current setting is displayed on the monitor (☰12).

- When **Auto** is selected, the **ISO** icon is not displayed at ISO 80, but is displayed if the ISO sensitivity automatically increases to higher than 80.
- When **ISO 80-200, ISO 80-400** or **ISO 80-800** is selected, the **ISO** icon and the maximum ISO sensitivity value are displayed.



Notes on ISO Sensitivity

- In **M** (manual) mode, when set to **Auto**, **ISO 80-200**, **ISO 80-400** or **ISO 80-800**, the ISO sensitivity is fixed at ISO 80.
- Some features cannot be used in combination with other menu settings. See “Features Not Available in Combination” (📖79) for more information.

Notes on ISO Sensitivity Settings in CSM (Movie Custom Setting) Mode













- In **Special effects** mode, **Shooting mode** (58) of the movie custom setting menu cannot be selected.
- **ISO 80-200**, **ISO 80-400**, **ISO 80-800**, **Hi 1** and **Minimum shutter speed** cannot be selected.
- When **Shooting mode** is set to **Aperture-priority auto** with **ISO sensitivity** set to **Auto**, ISO sensitivity is limited to the ISO 80 to 3200 range. When Shooting mode is set to **Manual**, ISO sensitivity is fixed at ISO 80.

WB White Balance (Adjusting Hue)

Rotate the mode dial to **P, S, A, M, U1, U2, U3,  or CSM** → **WB** (Quick menu dial) (69) → **White balance**



The color of light reflected from an object varies with the color of the light source. The human brain is able to adapt to changes in the color of the light source, with the result that white objects appear white whether seen in the shade, direct sunlight, or under incandescent lighting. Digital cameras can mimic this adjustment of the human eye by processing images according to the color of the light source. This is known as “white balance.” For natural coloration, choose a white balance setting that matches the light source before shooting.

Although the default setting, **Auto (normal)**, can be used under most types of lighting, you can apply the white balance setting suited to a particular light source to achieve more accurate results.

Option	Description
AUTO1  Auto (normal) (default setting)	The white balance is automatically adjusted to suit the lighting conditions. Default setting is suitable for most situations. When set to Auto (warm lighting) , the images are preserved with warm colors if they are shot under an incandescent light source. When using the flash, according to the brightness of the flash, the images are adjusted to suitable white balance.
AUTO2  Auto (warm lighting)	
 Daylight	The white balance is adjusted for direct sunlight.
 Incandescent	Use under incandescent lighting.
 Fluorescent (FL1 to FL3)	Use under most types of fluorescent lighting. Choose one of FL1 (white fluorescent), FL2 (daylight white/neutral fluorescent) and FL3 (daylight fluorescent).
 Cloudy	Use when shooting under overcast skies.
 Flash	Use with the flash.
 Choose color temp.	Use to directly specify color temperature ( 34). <ul style="list-style-type: none"> Select  Choose color temp. of White balance in the first line, and then select the value of Choose color temp. in the second line.
PRE  Preset manual (1 to 3)	Useful when shooting under unusual lighting. See “Using Preset Manual” ( 35) for more information.

The icon for the current setting other than **Auto (normal)** is displayed on the monitor (12).

Notes on White Balance

- At white balance settings other than **Auto (normal)**, **Auto (warm lighting)** or **Flash**, set the flash mode to  (off) (56).
- Some features cannot be used in combination with other menu settings. See “Features Not Available in Combination” (79) for more information.

Fine Adjustment of White Balance

To perform fine adjustment of the white balance setting, select **Fine-tune** and press the  button.

Press the multi selector , ,  or  to set fine adjustment value.

- The four directions are A (amber), B (blue), G (green) and M (magenta), and fine adjustment can be performed in six levels in all directions.
- When the  button is pressed, the fine adjustment value is reset to the center (coordinate 0, 0).
- Rotate the sub-command dial to return to the previous screen.

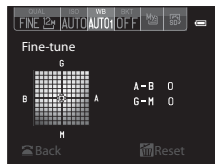

The color displayed in the fine-tune screen for white balance represents the approximate color in the color temperature direction. When a color is set in the fine-tune screen, it may not be reproduced exactly in the image. For example, when the white balance is set to **Incandescent**, the image will not have a strong blue color even if fine adjustment is performed in the B (blue) direction.

Color Temperature

The perceived color of a light source varies with the viewer and other conditions. Color temperature is an objective measure of the color of a light source, defined with reference to the temperature to which an object would have to be heated to radiate light in the same wavelengths. While light sources with a color temperature in the neighborhood of 5000–5500K appear white, light sources with a lower color temperature, such as incandescent light bulbs, appear slightly yellow or red. Light sources with a higher color temperature appear tinged with blue. The camera white balance options are adapted to the following color temperatures.

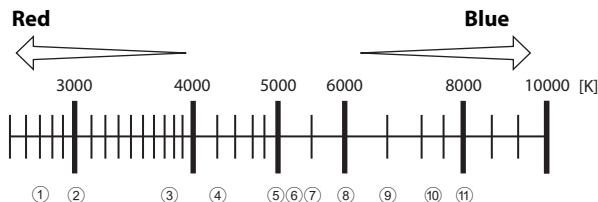

- | | |
|--|-----------------------------------|
| ① Sodium-vapor lamps: 2700K | ⑦ Flash: 5400K |
| ② Incandescent/
Warm-white fluorescent: 3000K | ⑧ Cloudy: 6000K |
| ③ White fluorescent: 3700K | ⑨ Daylight fluorescent: 6500K |
| ④ Cool-white fluorescent: 4200K | ⑩ High temp. mercury-vapor: 7200K |
| ⑤ Day white fluorescent: 5000K | ⑪ Shade: 8000K |
| ⑥ Direct sunlight: 5200K | |

Using Preset Manual

Use when you want to make pictures taken under unusual lighting conditions (such as lamps with reddish light) look as though they were shot in normal light. Use the procedure below to shoot after measuring the white balance value under the shooting light.

- Up to 3 preset values can be saved: PRE1, PRE2 and PRE3.

1 Place a white or gray reference object under the lighting that will be used during shooting.

2 Display the white balance quick menu (🔍33) and press the multi selector ◀ or ▶ to choose PRE1, PRE2 or PRE3.

- Items can also be chosen by rotating the main command dial.

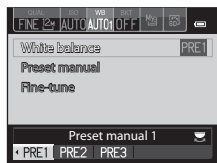

3 Press ▼ to choose **Preset manual** and press ◀ or ▶ to choose **PRE**.

- The lens extends to the zoom position for measurement.

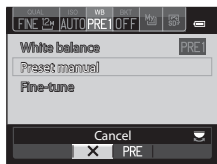

4 Frame a white or gray reference object in the reference object frame and press the Ⓚ button.

- The shutter is released and the new white balance preset value is set (no picture is recorded).

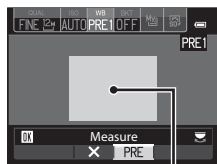

Reference object frame

✔ Note on Preset Manual

The camera cannot measure a white balance value for when the flash fires. When shooting with the flash, set **White balance** to **Auto (normal)**, **Auto (warm lighting)** or **Flash**.

🔗 Using the Previously Measured White Balance Value

Choose X in step 3. The most recently measured value is set for white balance, without performing measurement again.

🔗 Performing Fine Adjustment for the Measured White Balance Value

After selecting preset PRE1, PRE2 or PRE3, select **Fine-tune** and press the Ⓚ button to perform fine adjustment for white balance (🔍34).

BKT Bracketing (Continuous Shooting While Changing the Exposure and White Balance)

Rotate the mode dial to P, S, A, M, U1, U2 or U3 → BKT (Quick menu dial) (☰69) → Auto bracketing

Continuous shooting can be performed while changing the exposure (brightness) automatically with the shutter speed (Tv), the aperture value (Av) or ISO sensitivity (Sv), or multiple pictures can be recorded while varying the white balance (WB). This is effective when adjusting the brightness of an image is difficult, or when multiple light sources are mixed together and it is difficult to decide the white balance.

1 Press the multi selector ◀ or ▶ to choose the type of bracketing (☰37), and press ▼.

- Items can also be chosen by rotating the main command dial.

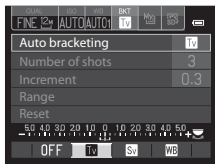

2 Choose the number of pictures to shoot and press ▼.

- 3 or 5 pictures can be chosen.

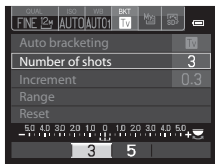

3 Choose the range of increment correction.

- For **Tv** (exposure bracketing (Tv)), **Av** (exposure bracketing (Av)) or **Sv** (exposure bracketing (Sv)), choose **0.3**, **0.7** or **1.0**.
- For **WB** (white balance bracketing), choose **1**, **2** or **3**. To set the bracketing range, press the ▼ button to select **Range**.

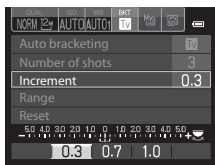





4 Press the quick menu button or the OK button.

- The monitor display reverts to shooting screen.
- To change the values to the default setting, select **Reset** and press the OK button.

More Information

See "Reverse Indicators" (☰90) for more information.

	Option	Description
	OFF OFF (default setting)	Bracketing is not performed.
	Exposure bracketing (Tv)	When the shutter-release button is pressed all the way, pictures are shot continuously while the shutter speed is adjusted automatically. • "Tv" means "Time value."
	Exposure bracketing (Av)	When the shutter-release button is pressed all the way, pictures are shot continuously while the aperture value is adjusted automatically. • "Av" means "Aperture value."
	Exposure bracketing (Sv)	When the shutter-release button is pressed all the way, pictures are shot continuously while changing the ISO sensitivity, with the shutter speed and aperture value fixed. • "Sv" means "Sensitivity value."
	White balance bracketing	When the shutter-release button is pressed all the way, one picture is shot, and the set number of pictures is recorded with the color temperature changed for each one.

The icon for the current setting other than **OFF** is displayed on the monitor (12).



Various types of bracketing can be set depending on the shooting mode.

Shooting mode	Exposure bracketing (Tv)	Exposure bracketing (Av)	Exposure bracketing (Sv)	White balance bracketing
P (Programmed auto)	✓	–	–	✓
S (Shutter-priority auto)	–	✓	–	✓
A (Aperture-priority auto)	✓	–	–	✓
M (Manual)	✓	–	✓	✓







Notes on Auto Bracketing

- When exposure compensation (66) is set with **AE Bracketing (Tv)**, **AE Bracketing (Av)** or **AE Bracketing (Sv)** simultaneously, a combined exposure compensation is applied. The new exposure compensation value updates the reference point to be displayed in the indicator.
- In **White balance bracketing**, only compensation for the color temperature (horizontal direction from A (amber) to B (blue)) is performed. Compensation in the vertical direction from G (green) to M (magenta) is not performed.
- Some features cannot be used in combination with other menu settings. See "Features Not Available in Combination" (79) for more information.

Picture Control (COOLPIX Picture Control) (Changing the Settings for Image Recording)

Rotate the mode dial to **P, S, A, M, U1, U2, U3** or **CSM** →  (Quick menu dial) ( 69)



Change the settings for image recording according to the shooting scene or your preferences. Sharpness, contrast and saturation can be adjusted in detail.

Option	Description
 Standard (default setting)	Standard processing for balanced results. Recommended for most situations.
 Neutral	Minimal processing for natural results. Choose for pictures that will later be extensively processed or retouched.
 Vivid	Pictures are enhanced for a vivid, photoprint effect. Choose for pictures that emphasize primary colors, such as blue, red, and green.
 Monochrome	Take monochrome photographs such as in black-and-white or sepia.
 Custom 1*	Change to the setting for Custom 1 in COOLPIX Custom Picture Control.
 Custom 2*	Change to the setting for Custom 2 in COOLPIX Custom Picture Control.

* Only displayed when the setting customized in **Custom Picture Control** ( 42) has been registered.

The icon for the current setting other than **Standard** is displayed on the monitor ( 12).

COOLPIX Picture Control

- The COOLPIX Picture Control feature of the COOLPIX P7700 cannot be used with other makes of cameras, Capture NX, Capture NX 2 and ViewNX 2 Picture Control feature.
- In **CSM** (movie custom setting) mode, Picture Control cannot be selected when **Shooting mode** ( 58) of the movie custom setting menu is set to **Special effects**.
- Some features cannot be used in combination with other menu settings. See “Features Not Available in Combination” ( 79) for more information.

Customizing Existing COOLPIX Picture Controls: Quick Adjust and Manual Adjust

COOLPIX Picture Control can be customized using Quick adjust, which allows for balanced adjustment of sharpness, contrast, saturation and other image editing components, or manual adjust, which allows for detailed adjusting of the components individually.

1 Use the multi selector to choose the type of COOLPIX Picture Control and press the **OK** button.

- Items can also be chosen by rotating the main command dial.

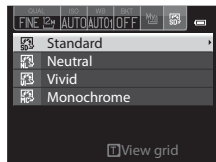

2 Press **▲** or **▼** to highlight the desired setting (**0-40**) and press **◀** or **▶** to choose a value.

- Press the **OK** button to set the value.
- When COOLPIX Picture Controls are modified from the default settings, an asterisk (*) is displayed after the options in the Picture Control Setting menu.
- To change the values to the default setting, select **Reset** and press the **OK** button.

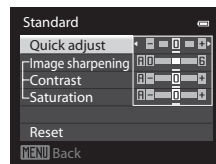

View Grid of COOLPIX Picture Control

When the zoom control is rotated toward **T (Q)** while the screen in step 1 of the above procedure is displayed, the contrast and saturation are displayed using a grid. The vertical axis indicates the contrast level, and the horizontal axis indicates the saturation. Rotate the zoom control toward **T (Q)** again to return to the previous screen.

The COOLPIX Picture Control grid displays the current and default settings in relation to the other COOLPIX Picture Controls.

- Rotate the multi selector to change to other COOLPIX Picture Controls.
- Press the **OK** button to display the COOLPIX Picture Control Setting screen (step 2 above).
- For **Monochrome**, the grid is displayed for contrast only.
- The grid is also displayed when adjusting **Contrast** or **Saturation** with manual adjustment.

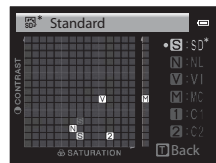

Types of Quick Adjust and Manual Adjust

Option	Description
Quick adjust ¹	Adjust the sharpness, contrast and saturation levels automatically. Five levels of adjustment are available from -2 to +2 . Choose from options between -2 and +2 to reduce or emphasize the effect of the selected COOLPIX Picture Control. The default setting is 0 .
Image sharpening	Control how much outlines are sharpened during shooting. Choose A (auto) to adjust sharpening automatically, or choose from seven levels of adjustment between 0 (no sharpening) and 6 . The higher the number, the sharper the image, and the lower the number, the softer the image. The default setting is 3 for Standard or Monochrome , 2 for Neutral and 4 for Vivid .
Contrast	Control the contrast. Choose A (auto) to adjust the contrast automatically according to the type of scene, or choose from seven levels of adjustment between -3 and +3 . – makes it into an image with a softer appearance, and + gives it a harder appearance. Choose lower values to prevent highlights in portrait subjects from being “washed out” in direct sunlight, higher values to preserve detail in misty landscapes and other low-contrast subjects. The default setting is 0 .
Saturation ²	Control the vividness of colors. Choose A (auto) to adjust saturation automatically according to the type of scene, or seven levels of adjustment can be done by choosing from values between -3 and +3 . Setting to the – side reduces the vividness, and setting to the + side increases the vividness. The default setting is 0 .
Filter effects ³	Simulate the effect of color filters on monochrome photographs. Choose from OFF (the default setting), Y (yellow), O (orange), R (red), and G (green). Y, O, R: Enhance contrast. Can be used to tone down the brightness of the sky in landscape photographs. The contrast is strengthened in the order Y → O → R . G: Soften skin tones. Suitable for portraits.



Option	Description
Toning ³	Control the tint used in monochrome photographs from B&W (black-and-white, the default setting), Sepia , and Cyanotype (blue-tinted monochrome). Pressing the rotary multi selector ▼ when Sepia or Cyanotype is selected enables you to choose from seven levels of saturation. Press ◀ or ▶ to adjust the saturation.

- 1 Quick adjust is not available in **Neutral**, **Monochrome**, **Custom 1** and **Custom 2**. The values set manually are disabled if quick adjust is used after manual setting.
- 2 Not displayed for **Monochrome**.
- 3 Only displayed for **Monochrome**.

Notes on Image sharpening

- The effects of **Image sharpening** cannot be previewed on the monitor during shooting. Check the results in playback mode.
- In  CSM (movie custom setting) mode, the image sharpening effect is fixed at **A** (auto).

Note on Contrast

When **Active D-Lighting** (53) is set to settings other than **Off**, the  mark is displayed for **Contrast** and contrast cannot be adjusted.

Contrast, Saturation and A (Auto)

- Results for contrast and saturation vary with the exposure, and the position and size of the subject in the frame.
- The setting for the COOLPIX Picture Control which has **A** (auto) selected for either **Contrast** or **Saturation** is displayed in green in the COOLPIX Picture Control grid.

Options that Can Be Adjusted in Custom 1 and Custom 2

The same option as that of the original COOLPIX Picture Control can be adjusted if **Custom 1** or **Custom 2** is selected.

Shooting Menu (P, S, A or M Mode)

Custom Picture Control (COOLPIX Custom Picture Control)

Rotate the mode dial to P, S, A, M, U1, U2 or U3 → MENU button → P, S, A or M tab (10) → Custom Picture Control

The picture editing options created by customizing COOLPIX Custom Picture Controls can be registered up to 2 options. The registered options can be displayed as **Custom 1** and **Custom 2** in COOLPIX Custom Picture Control.

Creating COOLPIX Custom Picture Controls

- 1 Use the multi selector to choose **Edit and save**, and press the **OK** button.

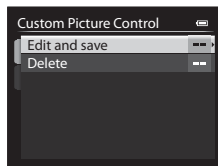

- 2 Choose the original COOLPIX Picture Control (39) to be edited, and press the **OK** button.

- 3 Press **▲** or **▼** to highlight the desired setting and press **◀** or **▶** to choose a value (39).

- The options are the same as those for adjusting the COOLPIX Picture Control.
- Press the **OK** button to display the **Save as** screen.
- To change the values to the default setting, select **Reset** and press the **OK** button.

- 4 Choose the registration destination and press the **OK** button.

- The COOLPIX Custom Picture Control is registered.
- **Custom 1** or **Custom 2** can be selected from the **Picture Control** and **Custom Picture Control** selection screen after registration.

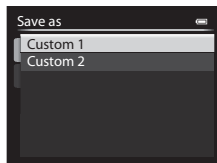

Deleting COOLPIX Custom Picture Controls



Select **Delete** in step 1 of "Creating COOLPIX Custom Picture Controls" to delete a registered Custom Picture Control.

Metering

Rotate the mode dial to **P, S, A, M, U1, U2** or **U3** → MENU button → **P, S, A** or **M** tab (📖10) → Metering

The process of measuring the brightness of the subject to determine the exposure is known as “metering.”

Use this option to choose how the camera meters exposure.

Option	Description
 Matrix (default setting)*	The camera uses a wide area of the screen for metering. This metering mode provides the appropriate exposure for a variety of shooting conditions. Recommended for typical shooting.
 Center-weighted	The camera meters the entire frame but assigns greatest weight to the subject at the center of the frame. The classic metering for portraits; it preserves background details while letting lighting conditions at the center of the frame determine exposure. Can be used with focus lock (📖86) to meter off-center subjects.
 Spot*	The camera meters the area shown by the circle at the center of the frame. This can be used when the subject is much lighter or darker than the background. Ensure that the subject is within the area shown by the circle when shooting. Can be used with focus lock (📖86) to meter off-center subjects.

* When **Focus-coupled metering** is set to **On** and **AF area mode** (📖47) is set to **Manual**, the brightness of the subject is measured by giving higher priority to the focus area. See “Focus-coupled Metering” (📖55) for more information.

Notes on Metering

- When the digital zoom is in effect, **Metering** is set to **Center-weighted** or **Spot** depending on the magnification of an enlargement.
- Some features cannot be used in combination with other menu settings. See “Features Not Available in Combination” (📖79) for more information.









Metering Area

- When **Center-weighted** or **Spot** is selected for **Metering**, the metering range guide (📖12) is displayed (except when digital zoom is used).
- When **Focus-coupled metering** is set to **On** (default setting), the metering range guide for **Spot** is not displayed.

Continuous Shooting

Rotate the mode dial to P, S, A, M, U1, U2 or U3 → MENU button → P, S, A or M tab (10) → Continuous

Change the settings for continuous shooting and BSS (Best Shot Selector).

Option	Description
 Single (default setting)	One picture is shot each time the shutter-release button is pressed.
 Continuous H	Pictures are continuously shot while the shutter-release button is pressed all the way. Shooting ends when the shutter-release button is released or when the maximum number of continuous shooting frames is reached.
 Continuous M	<ul style="list-style-type: none"> • Continuous H: Up to about 6 pictures are continuously shot at a rate of about 8 frames per second. • Continuous M: Up to about 6 pictures are continuously shot at a rate of about 4 frames per second.
 Continuous L	<ul style="list-style-type: none"> • Continuous L: Up to about 30 pictures are continuously shot at a rate of about 1 frame per second (when image quality is set to Normal and image size is set to  4000×3000).
 BSS BSS (Best Shot Selector)	BSS is recommended for shooting under low lighting without the flash, with the camera zoomed in, or in other situations in which camera shake is likely to blur pictures. Keep pressing the shutter-release button all the way, and up to 10 pictures are shot and the camera automatically selects and saves only the sharpest picture in the series.
 Multi-shot 16	Each time the shutter-release button is pressed all the way, the camera shoots 16 pictures at a rate of about 30 frames per second and arranges them in a single picture. <ul style="list-style-type: none"> • The image size is fixed at  (2560 × 1920 pixels). • The digital zoom is not available. 
120 Continuous H: 120 fps	Each time the shutter-release button is pressed all the way, pictures are continuously shot using a high shutter speed. <ul style="list-style-type: none"> • Continuous H: 120 fps: 60 frames are captured at a speed of about 1/125 seconds or faster.
60 Continuous H: 60 fps	<ul style="list-style-type: none"> • Continuous H: 60 fps: 60 frames are captured at a speed of about 1/60 seconds or faster. The image size to be recorded is fixed at  (1280 × 960 pixels).
 Intvl timer shooting	The camera shoots still pictures automatically at the specified interval (0-45).

The icon for the current setting other than **Single** is displayed on the monitor (12).

✔ Notes on Continuous Shooting

- Focus, exposure and white balance are fixed at the values determined with the first shot in each series.
- The frame rate may become slower depending on the image quality, image size, memory card type or shooting conditions.
- Some features cannot be used in combination with other menu settings. See “Features Not Available in Combination” (📖79) for more information.

✔ Note on BSS

BSS is suited for shooting stationary subjects. BSS may not produce the desired results if the subject moves or the composition changes.

✔ Note on Multi-shot 16

Banding or variance in brightness or hue may occur in images that were captured under lighting that flashes quickly at high speeds, such as fluorescent, mercury-vapor, or sodium-vapor lighting.

✔ Notes on Continuous H

- It may take some time to save the images after shooting. The amount of time it takes to finish saving the captured images depends on the number of images, the write speed of the memory card, etc.
- When ISO sensitivity increases, noise may appear in captured images.
- Banding or variance in brightness or hue may occur in images that were captured under lighting that flashes quickly at high speeds, such as fluorescent, mercury-vapor, or sodium-vapor lighting.

Interval Timer Shooting

Rotate the mode dial to P, S, A, M, U1, U2 or U3 → MENU button → P, S, A or M tab (📖10) → Continuous

Choose from **30 s**, **1 min**, **5 min** or **10 min**.

- 1 Use the multi selector to select **Intvl timer shooting** for the **Continuous** setting, and then press the **OK** button.

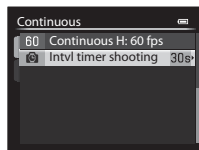

2 Choose the interval between each shot and press the **OK** button.

- The maximum amount of frames that can be taken during interval timer shooting differs according to the selected interval.
 - 30 s:** 600 images
 - 1 min:** 300 images
 - 5 min:** 60 images
 - 10 min:** 30 images

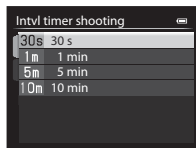

3 Press the **MENU** button.

- The camera returns to shooting screen.

4 Press the shutter-release button all the way to shoot the first picture and start interval timer shooting.

- The monitor is turned off and the power-on lamp flashes between shots.
- The monitor reactivates automatically immediately before the next picture is shot.

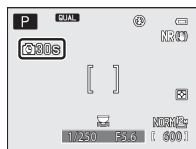

5 Press the shutter-release button all the way again to finish shooting.

- Shooting finishes automatically if the internal memory or memory card becomes full, or when the number of shot frames reaches the upper limit.

✓ Notes on Interval Timer Shooting

- To prevent the camera from turning off unexpectedly during shooting, use a fully charged battery.
- If the AC Adapter EH-5b and the Power Connector EP-5A (available separately) (🔌103) are used, COOLPIX P7700 can be powered from an electrical outlet. Do not, under any circumstances, use an AC Adapter other than the EH-5b or a Power Connector other than the EP-5A. Failure to observe this precaution could result in overheating or damage to the camera.
- Do not rotate the mode dial to a different setting while performing interval timer shooting.

📄 More Information



See "File and Folder Names" (🔍100) for more information.



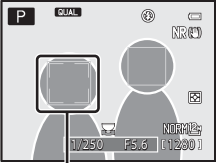

AF Area Mode

Rotate the mode dial to **P, S, A, M, U1, U2, U3** or **EFFECTS** → MENU button
→ **P, S, A, M** or  tab (10) → AF area mode

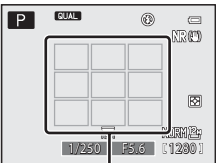
You can set how the focus area is determined for autofocus.

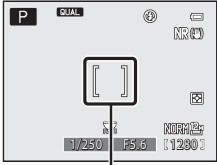

- The AF area mode can also be selected by pressing the multi selector ► (H) (55, 81).
- In **P, S, A** or **M** mode, the default setting is **Center (normal)**.
- In **EFFECTS** mode, the default setting is **Auto**.

Option	Description	
 Face priority	<p>The camera automatically detects and focuses on a face (see “Using Face Detection” (85) for more information). If the camera detects multiple faces, the camera focuses on the face closest to the camera. When non-human subjects are photographed, or a subject with which no face can be detected is framed, AF area mode is set to Auto. The camera automatically selects the focus areas (up to 9) that contain the subject closest to the camera.</p>	 <p style="text-align: center;">Focus area</p>
 Auto	<p>The camera automatically selects the focus areas (up to 9) that contain the subject closest to the camera. Press the shutter-release button halfway to activate the focus area. When the shutter-release button is pressed halfway, the focus area selected by the camera is displayed on the monitor (up to 9 areas).</p>	 <p style="text-align: center;">Focus areas</p>

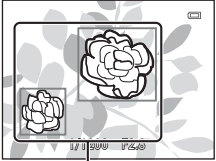
Option	Description
<p data-bbox="104 355 218 379">  Manual </p>	<p data-bbox="334 144 658 291">Choose manually the focus position from 99 areas in the screen. This option is suited to situations in which the intended subject is relatively still and not positioned at the center of the frame.</p> <p data-bbox="334 295 640 393">Rotate the multi selector or press ▲, ▼, ◀ or ▶ to move the focus area to where the subject is, and take a picture.</p> <ul data-bbox="334 397 928 596" style="list-style-type: none"> <li data-bbox="334 397 928 547">• To adjust the following settings, press the OK button to temporarily cancel focus area selection, and then adjust each setting. <ul data-bbox="355 473 717 495" style="list-style-type: none"> <li data-bbox="355 473 717 495">- Flash mode, focus mode or self-timer To return to the focus area selection screen, press the OK button again. <li data-bbox="334 551 928 596">• At an Image size setting (📖77) of 3000×3000, 81 focus areas are available.
<p data-bbox="42 697 63 855" style="writing-mode: vertical-rl; transform: rotate(180deg);">Reference Section</p> <p data-bbox="104 697 296 743">  Center (normal)  Center (wide) </p>	<p data-bbox="334 610 645 760">The camera focuses at the center of the frame. The focus area is always displayed at the center of the frame. Two sizes are available for the focus area.</p>  <p data-bbox="759 809 862 831">Focus area</p>
<p data-bbox="104 925 301 949">  Subject tracking </p>	<p data-bbox="334 844 640 970">Subject tracking begins once you select a subject to be focused on, and the focus area will move and follow the subject. See "Using Subject Tracking" (📖49).</p>  <p data-bbox="759 809 862 831">Focus area</p>

Option	Description
 Target finding AF	<p>When the camera detects the main subject, it focuses on that subject. See "Using the Target Finding AF" (📖 84) for more information.</p>  <p style="text-align: center;">Focus areas</p>

✓ Notes on AF Area Mode

- When the digital zoom is in effect, the camera focuses on the subject at the center of the frame regardless of the applied **AF area mode** option.
- In some rare cases of shooting subjects for which autofocus does not perform as expected (📖 86), the subject may not be in focus.
- Some features cannot be used in combination with other menu settings. See "Features Not Available in Combination" (📖 79) for more information.
- In special effects mode,  (subject tracking) and  (target finding AF) cannot be used. For **Zoom exposure**, the setting is fixed at **Center (normal)**.
- If the camera does not focus on the desired subject when using a feature that selects and focuses on the subject, such as Target finding AF, set **AF area mode** to **Manual**, **Center (normal)** or **Center (wide)** and align the focus area with the desired subject. You can also try using focus lock (📖 86).

Using Subject Tracking

Rotate the mode dial to P, S, A, M, U1, U2 or U3 → MENU button → P, S, A or M tab (📖 10) → AF area mode

Choose this mode to shoot moving subjects. Subject tracking begins once you select a subject to be focused on, and the focus area will move and follow the subject.

1 Rotate the multi selector to select **Subject tracking**, and press the button.

- Press the MENU button after changing the settings and return to the shooting screen.

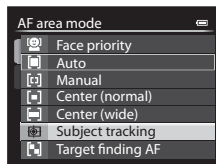

2 Frame the subject at the center of the border, and press the **OK** button.

- The subject is registered.
- When the camera is unable to focus on the subject, the border lights in red. Change the composition and try again.
- Once the subject is registered, it is framed by a yellow focus area display, and subject tracking begins.
- Press the **OK** button to cancel the registration of the subject.
- If the camera loses sight of the subject, the focus area display disappears; register the subject again.

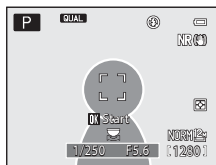

3 Press the shutter-release button all the way to take the picture.

- If the camera focuses on the focus area when the shutter-release button is pressed halfway, the focus area display lights in green and the focus is locked.
- If the shutter-release button is pressed halfway while the focus area is not displayed, the camera focuses the subject at the center of the frame.

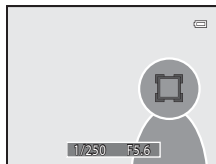

✓ Notes on Subject Tracking

- The digital zoom is not available.
- Set the zoom position, flash mode, focus mode, or menu settings before registering a subject. If any of these are changed after a subject is registered, the subject will be canceled.
- During certain conditions, such as when the subject is moving quickly, when there is a large amount of camera shake, or when there are multiple subjects that look alike, the camera may not be able to register or track a subject, or the camera may track a different subject. Additionally, the subject may not be tracked properly depending on factors such as the subject's size and brightness.
- When the camera enters standby mode (📖23), the registration of the subject is canceled. To prevent this, setting a longer time for the auto off function (📖78) is recommended.
- Some features cannot be used in combination with other menu settings. See "Features Not Available in Combination" (📖79) for more information.

Autofocus Mode

Rotate the mode dial to P, S, A, M, U1, U2 or U3 → MENU button → P, S, A or M tab (📖10) → Autofocus mode

Choose how the camera focuses.

Option	Description
AF-S Single AF (default setting)	The camera focuses only when the shutter-release button is pressed halfway.
AF-F Full-time AF	The camera focuses continuously until the shutter-release button is pressed halfway. Use with moving subjects. A sound will be heard while the camera focuses.

✔ Note on Autofocus Mode

Some features cannot be used in combination with other menu settings. See “Features Not Available in Combination” (📖79) for more information.

📌 Autofocus Mode for Movie Recording

Autofocus mode for movie recording can be set with **Autofocus mode** (🔍59) in the movie menu or movie custom setting menu.

Flash Exp. Comp.

Rotate the mode dial to P, S, A, M, U1, U2 or U3 → MENU button → P, S, A or M tab (📖10) → Flash exp. comp.

Flash exp. comp. option is used to adjust the flash output.

Use this option when the flash is too bright or too dark.

Option	Description
+0.3 to +2.0	The flash output is increased from +0.3 to +2.0 EV, in increments of 1/3 EV, to make the main subject of the frame appear brighter.
0.0 (default setting)	The flash output is not adjusted.
-0.3 to -2.0	The flash output is reduced from -0.3 to -2.0 EV, in increments of 1/3 EV, to prevent unwanted highlights or reflections.

The icon for the current setting other than **0.0** is displayed on the monitor (📖12).

✔ Note on Flash Exp. Comp.

When flash exposure compensation has been set on the optional flash unit the compensation values on the camera and the Speedlight are added.

Noise Reduction Filter

Rotate the mode dial to P, S, A, M, U1, U2 or U3 → MENU button → P, S, A or M tab (📖10) → Noise reduction filter

Set the strength of the noise reduction function that is normally performed when recording the picture.

Option	Description
NR* High	Perform noise reduction at a level higher than the standard strength.
NR Normal (default setting)	Perform noise reduction at the standard strength.
NR Low	Perform noise reduction at a level lower than the standard strength.

Noise reduction filter setting can be confirmed on the monitor when recording a picture (📖12).

Built-in ND Filter

Rotate the mode dial to P, S, A, M, U1, U2 or U3 → MENU button → P, S, A or M tab (📖10) → Built-in ND filter

When the camera's built-in ND filter is used, the amount of light that enters the camera can be reduced to about one-eighth (equivalent to three steps lower in terms of the exposure value) while shooting. Use in situations such as when overexposure results from the subject being too bright.

Option	Description
On	Use the ND filter to reduce the light.
Off (default setting)	The ND filter is not used.

The icon for the current setting other than **Off** is displayed on the monitor (📖12).

Effects of the Built-in ND Filter

Using the filter may enable the shooting of subjects that are too bright without overexposing the image. It can also be used in situations such as when you want to slow down the shutter speed at a low aperture value.

For example, at a shutter speed of 1/2000 second with the correct exposure, if the ND filter is used to reduce the light in three steps, the speed can be changed to 1/250 second without changing the aperture value.

Distortion Control

Rotate the mode dial to **P, S, A, M, U1, U2** or **U3** → **MENU** button → **P, S, A** or **M** tab (📖10) → Distortion control

Choose whether to correct the peripheral distortion that occurs due to the intrinsic characteristics of lenses.

Option	Description
On	Distortion is corrected. The size of the frame is reduced, as compared to when distortion control is not enabled.
Off (default setting)	Distortion is not corrected.

When **On** is selected, an icon for this setting is displayed on the monitor (📖12).

Active D-Lighting

Rotate the mode dial to **P, S, A, M, U1, U2** or **U3** → **MENU** button → **P, S, A** or **M** tab (📖10) → Active D-Lighting

“Active D-Lighting” preserves details in highlights and shadows, creating photographs with natural contrast. The image taken reproduces the contrast effect that is seen with the naked eye. This is particularly effective for shooting scenes with high contrast, such as brightly lit outdoor scenery from a dark room or shaded subjects at a sunny seaside.

Option	Description
 High Normal Low	Set the level of the Active D-Lighting effect that is applied during shooting.
OFF Off (default setting)	Active D-Lighting is not applied.

The icon for the current setting other than **Off** is displayed on the monitor (📖12).

✓ Notes on Active D-Lighting

- Additional time is required to record images when shooting using Active D-Lighting.
- The exposure is reduced in comparison to shooting with Active D-Lighting set to **Off**. To ensure that the gradation is appropriate, adjustments of the highlighted areas, shadow areas and mid-tones are made before recording.
- Some features cannot be used in combination with other menu settings. See “Features Not Available in Combination” (📖79) for more information.

✓ Active D-Lighting Versus D-Lighting

The **Active D-Lighting** option in the shooting menu reduces exposure before shooting to optimize the dynamic range. The **D-Lighting** (📖12) option in the playback menu optimizes dynamic range in pictures taken.

Zoom Memory

Rotate the mode dial to P, S, A, M, U1, U2 or U3 → MENU button → P, S, A or M tab (10) → Zoom memory

When the zoom control is operated while pressing the **Fn1** button, the camera changes in steps to the focal length (equivalent to 35mm [135] format of angle of view) of the zoom lens that is set in advance. The following settings are available:

28 mm, 35 mm, 50 mm, 85 mm, 105 mm, 135 mm and **200 mm**.

- Choose the focal length with the multi selector, and then press the **OK** button to set the check box to On [✓] or Off.
- Multiple focal lengths can be chosen.
- The default setting is On [✓] for all the check boxes.
- To finish the setting, press the multi selector ▶.
- The focal length set in the **Startup zoom position** is automatically set to On [✓].

Notes on Zoom Operation

- Operate the zoom control while pressing the **Fn1** button to change to the focal length for which the zoom memory is set to on.
- The changed focal length is the closest to that before the operation. To change the next focal length level, release the zoom control and then operate it again.
- Release your finger from the **Fn1** button when using the digital zoom.

Startup Zoom Position

Rotate the mode dial to P, S, A, M, U1, U2 or U3 → MENU button → P, S, A or M tab (10) → Startup zoom position

When the camera is turned on, the zoom position moves to the focal length (equivalent to 35mm [135] format of angle of view) of the zoom lens that is set in advance.

The following settings are available: **28 mm** (default setting), **35 mm, 50 mm, 85 mm, 105 mm, 135 mm** and **200 mm**.

M Exposure Preview

Rotate the mode dial to P, S, A, M, U1, U2 or U3 → MENU button → P, S, A or M tab (📖10) → M exposure preview

When the shutter speed and aperture value combination is changed in **M** (manual) mode, the brightness of the shooting screen will be set accordingly.

When the setting is set to **On**, the brightness of the shooting screen changes.

- The default setting is **Off**.

Focus-coupled Metering

Rotate the mode dial to P, S, A, M, U1, U2 or U3 → MENU button → P, S, A or M tab (📖10) → Focus-coupled metering

Set whether or not to measure the brightness by giving higher priority to the focus area when **AF area mode** (🔍47) is set to **Manual**.

Option	Description
On (default setting)	When Metering (🔍43) is set to Matrix , the brightness is measured with emphasis on the focus area. When Metering is set to Spot , the brightness is measured in the focus area.
Off	The function for measuring the brightness coupled with the selected focus area is disabled.

Commander Mode

Rotate the mode dial to P, S, A, M, U1, U2 or U3 → MENU button → P, S, A or M tab (📖10) → Commander mode

Set how the wirelessly-controlled optional flash unit fires when the flash mode (📖56) is set to **⚡CMD** (commander mode).

- Commander mode is only supported when the group setting for the remote flash unit is "Group A" and the channel is set to "3 CH."

Option	Description
Flash mode	<p>Standard flash (default setting): The flash unit (Speedlight) fires regardless of how bright the subject is.</p> <p>Slow sync: The flash unit illuminates the main subject and at the same time slow shutter speeds are used to capture the background.</p> <p>Rear-curtain sync: The flash unit fires forcibly just before the shutter closes.</p> <p>Red-eye reduction: Best choice for portraits. If the camera detects "red-eye" when a picture is taken, it reduces the red-eye effect before recording the image (📖58).</p>
Flash control mode	<p>TTL (default setting): Fill flash fires with the amount of light emitted by all flash units (Speedlights) automatically adjusted according to the shooting conditions.</p> <ul style="list-style-type: none"> • The compensation value is from -3.0 EV to +3.0 EV. <p>Manual: Fill flash fires after adjusting the amount of light emitted by all flash units.</p> <ul style="list-style-type: none"> • Select the flash output from M⚡Full (full flash), M⚡1/2, M⚡1/4, M⚡1/8, M⚡1/16, M⚡1/32, M⚡1/64 and M⚡1/128.

More Information

- See "Using the Commander Mode" (📖57) for more information.
- See "Speedlights (External Flash Unit)" (📖87) for more information.

Using the Commander Mode

When the flash mode (☐57) is set to **⚡CMD** (commander mode), you can wirelessly control an off-camera optional flash unit.

- Set the group and channel settings for the remote flash unit to “Group A” and “3 CH,” respectively.
- Place the flash unit within the range shown in the diagram below.
- Set up the remote flash unit facing the camera to ensure that the light from the built-in flash will enter the wireless remote sensor window of the remote flash unit. Set up the remote flash unit in a position closer to the subject than the camera.

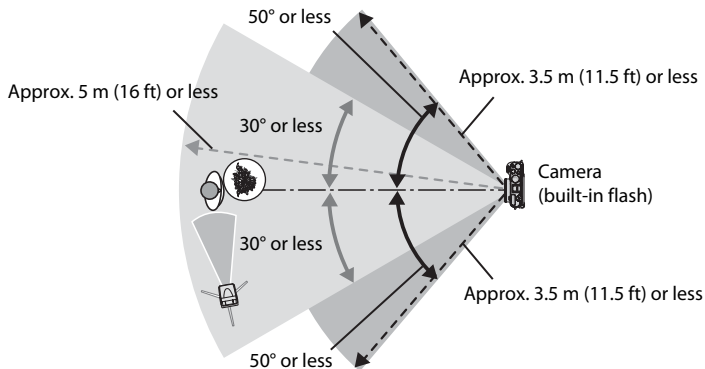

- The distances shown in the diagram above may vary depending on the surrounding environment.

✓ Notes on Using Commander Mode



- In commander mode, the camera's built-in flash emits low-level flashes in order to control the flash unit. Therefore, the built-in flash must always be raised when using commander mode. The remote flash unit fires in accordance with the **Commander mode** options (⚙56) set.
- The built-in flash is not usable when it is set to the commander mode.
- Ensure that light directly from the flash unit or strong reflections do not enter the shooting lens of the camera. It may not be possible to obtain the correct exposure if such light enters the lens.
- If the light of the remote flash bounces and does not directly light a subject, set the **Flash control mode** of the **Commander mode** (⚙56) to **Manual** in order to adjust the flash output.
- Aside from monitor pre-flashes, the camera's built-in flash emits low-level flashes during shooting to match the flash timing of the flash unit. When shooting a subject at close distance, these low-level flashes may be captured on the image. To prevent such adverse effects, use a lower ISO sensitivity or a larger aperture value (☐49).
- Refer to the Speedlight's instruction manual for more information on flash unit settings.

Specialized Menu for U1, U2 or U3

To set the specialized menu for **U1**, **U2** and **U3** (**U1**, **U2** and **U3** tabs), see “**U1, U2 and U3 (User Settings Modes)**” (📖52) and “**Available Specialized Menu for U1, U2 or U3**” (📖73).

Movie and Movie Custom Setting Menus

Shooting Mode (Movie Custom Setting Only)

Rotate the mode dial to  CSM → MENU button →  (Movie custom setting) tab (📖107) → Shooting mode

Set the standard shooting mode during  CSM (movie custom setting) mode.

Option	Description
Aperture-priority auto (default setting)	Use this mode to shoot subjects clearly with both the foreground and background in focus or to blur the subject's background intentionally (📖50).
Manual	Use this mode to control the exposure according to shooting requirements (📖50).
Special effects	Use this mode to apply the effects to pictures during shooting. One of the 7 special effects can be selected for shooting. <ul style="list-style-type: none">• Painting (default setting), Cross process, Soft, Nostalgic sepia, High key, Low key and Selective color See 📖45 for more information on characteristics of each special effect.

Note on Shooting Mode

Some features cannot be used in combination with other menu settings. See “Features Not Available in Combination” (📖79) for more information.

Custom Picture Control (Movie Custom Setting Only)

To set Custom Picture Control, see “Custom Picture Control (COOLPIX Custom Picture Control)” (📖42).

Autofocus Mode

Rotate the mode dial to or CSM → MENU button → (Movie) or (Movie custom setting) tab (📖107) → Autofocus mode

Select how the camera focuses when recording normal speed movies (28).

Option	Description
AF-S Single AF (default setting)	Lock on the focus when movie recording starts. Select this option when the distance between the camera and the subject remains fairly consistent.
AF-F Full-time AF	The camera focuses continuously during movie recording. Suitable for shooting when the distance between the camera and subject changes. The operation sound when the camera focuses may be recorded. Setting to Single AF is recommended if the sound is noticeable.

Note on Autofocus Mode

Some features cannot be used in combination with other menu settings. See “Features Not Available in Combination” (📖79) for more information.

Built-in ND Filter (Movie Custom Setting Only)

To set built-in ND filter, see “Built-in ND Filter” (52).

Wind Noise Reduction

Rotate the mode dial to or CSM → MENU button → (Movie) or (Movie custom setting) tab (📖107) → Wind noise reduction

Option	Description
On	Record movies with the reduced wind noise from the microphone. This setting is suitable for recording in strong winds. During playback, not only wind noise, but other sounds may also become difficult to hear.
OFF Off (default setting)	Wind noise is not reduced.

When **On** is selected, an icon for this setting is displayed on the monitor (📖12).

The Playback Menu

For more information about image editing functions; (**Quick retouch**, **D-Lighting**, **Skin softening**, **Filter effects**, **Small picture**, **Black border**, **Straighten** and **NRW (RAW) processing**), see “Editing Still Images” (🔗10).

🖨️ Print Order (Creating a DPOF Print Order)

Press the  button (Playback mode) → MENU button (📖10) → 🖨️ Print order





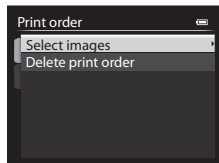

If you choose to use one of the following methods to print pictures that are stored on a memory card, the pictures to print and the number of copies can be set in advance on the memory card.

- Printing with a DPOF-compatible (🔗17) printer that is equipped with a card slot.
- Ordering the prints to a digital photo lab that has a DPOF service.
- Printing by connecting the camera to a PictBridge-compatible (🔗17) printer (🔗21). (When the memory card is removed from the camera, the print order can also be performed for the pictures stored on the internal memory.)

1 Use the multi selector to choose **Select images**, and press the button.





2 Choose the pictures (up to a maximum of 99) and number of copies (up to 9 per picture).

- Rotate the multi selector or press  or  to choose the pictures, and press  or  to set the number of copies for each.
- Pictures selected for printing can be recognized by the check mark icon and the numeral indicating the number of copies to be printed. If no copies have been specified for pictures, the selection is canceled.
- Rotate the zoom control toward **T** () to switch to full frame playback mode, or **W** () to switch to 12 thumbnail display.
- Press the  button when setting is complete.



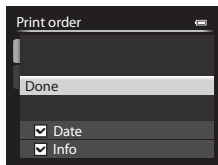

3 Choose whether or not to also print shooting date and shooting information.

- Choose **Date** and press the **OK** button to print the shooting date on all pictures in the print order.
- Choose **Info** and press the **OK** button to print shooting information (shutter speed and aperture value) on all pictures in the print order.
- Choose **Done** and press the **OK** button to complete the print order.
- Pictures with the print orders are recognized by the  icon displayed in playback mode (14).



✓ Notes on Printing Shooting Date and Shooting Information

When the **Date** and **Info** options are enabled in the print order menu, shooting date and shooting information can be printed on pictures when a DPOF-compatible (17) printer which supports printing of shooting date and shooting information is used.

- Shooting information cannot be printed when the camera is connected directly to a printer, via the included USB cable, for DPOF printing (24).
- **Date** and **Info** are reset each time the **Print order** menu is displayed.
- The date printed on the picture is the same as those set on the camera when the picture was taken. The date printed using this option is not affected if the camera's **Time zone and date** setting is changed from the setup menu after the pictures are taken.



✓ Note on Print Order

NRW (RAW) pictures cannot be set for print order. Create a JPEG picture using **NRW (RAW) processing** (16), and then set the JPEG picture for print order.

Deleting All Print Orders

In step 1 of the print order procedure (60), choose **Delete print order** and press the **OK** button to delete the print orders for all pictures.



Print Date

The shooting date and time can be imprinted on pictures at the time of shooting by using **Print date** (72) in the setup menu. This information can be printed even from printers that do not support printing of the date. Only the date of print date on the pictures are printed, even if **Print order** is enabled with the date selected in the print order screen.

More Information



See "Printing Images of Size 1:1" (78) for more information.

Slide Show

Press the  button (Playback mode) → MENU button (10) →  Slide show



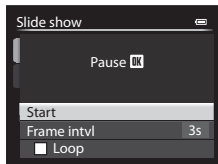

View pictures stored in the internal memory or on a memory card in an automatic slide show.

1 Use the multi selector to choose **Start**, and press the button.

- To change the interval between pictures, choose **Frame intvl**, and press the  button, and then select the desired interval time before choosing **Start**.
- To repeat the slide show automatically, enable **Loop** and press the  button before choosing **Start**. The check mark () is added to the loop option when enabled.





2 The slide show begins.

- Press the multi selector  to display the next picture, or  to display the previous picture. Press and hold  to fast forward, or  to rewind.
- To exit partway or pause, press the  button.





3 Choose End or Restart.



- After the last frame is played back or during playback pause, the screen shown on the right is displayed. Choose  and press the  button to return to step 1. Choose  to play the slide show again.



Notes on Slide Shows



- Only the first frame of movies (109) included in slide shows is displayed.
- For sequences (8) whose sequence display options are set to **Key picture only**, only the key picture is displayed.
- Images captured using Easy panorama are displayed full-frame when played in a slide show. They do not scroll.
- Slide shows play for a maximum of about 30 minutes, even when **Loop** is selected (78).

Delete



Press the  button (Playback mode) → MENU button (10) →  Delete

Delete a picture. Multiple pictures can also be deleted.



Select an image to be deleted in the image selection screen. See “Using the Screen for Selecting Images” (95) for more information.

Option	Description
Erase selected images	<p>In the image selection screen, choose the pictures for deletion. See “Using the Screen for Selecting Images” (95) for more information.</p> <ul style="list-style-type: none"> When images saved with an Image quality (75) setting of NRW (RAW) + Fine or NRW (RAW) + Normal are selected, the NRW (RAW) and JPEG images are deleted at the same time. When a sequence (8) for which only a key picture is displayed is selected, all images in the displayed sequence are deleted.
All images	<p>Delete all pictures.</p> <ul style="list-style-type: none"> This option is not available when individual images in the sequence are displayed.
Entire sequence	<p>Delete all images in the same sequence including the individual image that is displayed.</p> <ul style="list-style-type: none"> This option is available when individual images in the sequence are displayed.
Erase selected NRW images	<p>Only NRW (RAW) images are displayed in the image selection screen. Select and delete images.</p> <ul style="list-style-type: none"> For pictures where NRW (RAW) and JPEG images are recorded at the same time, only the NRW (RAW) image is deleted.
Erase selected JPEG images	<p>Only JPEG images are displayed in the image selection screen. Select and delete pictures.</p> <ul style="list-style-type: none"> For pictures where NRW (RAW) and JPEG images are recorded at the same time, only the JPEG image is deleted.

Notes on Deletion

- Deleted images cannot be recovered. Transfer important images to a computer before deleting them.
- Pictures marked with the  icon are protected and cannot be deleted (64).
-  is displayed in the image selection screen for pictures where NRW (RAW) and JPEG images are recorded at the same time.



Protect

Press the  button (Playback mode) → MENU button (10) →  Protect

Protect selected pictures from accidental deletion.

In the image selection screen, choose a picture and set or cancel protection. See “Using the Screen for Selecting Images” (95) for more information.

Note, however, that formatting the camera’s internal memory or the memory card (79) permanently erases the protected files.



Protected pictures are recognized by the  icon in playback mode (15).

Rotate Image

Press the  button (Playback mode) → MENU button (10) →  Rotate image

Change the orientation of pictures played back in the camera’s monitor after shooting. Still pictures can be rotated 90° clockwise or counterclockwise.

Pictures that were recorded in the “tall” orientation can be rotated up to 180° in either direction.

Select a picture in the picture selection screen (95) to display the rotate image screen. Rotate the multi selector, or press  or  to rotate the picture 90°.

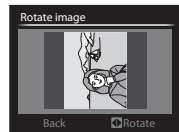

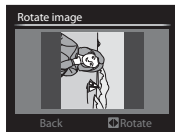

Rotated 90°
counterclockwise





Rotated 90°
clockwise

Press the  button to set the orientation displayed and save the orientation data with the picture.

Notes on Image Rotation

- Images captured using 3D photography cannot be rotated.
- While only the key picture of a sequence is displayed, images cannot be rotated. Apply the setting after displaying individual images (08, 67).



Voice Memo

Press the  button (Playback mode) → Select a picture → MENU button (10)
→  Voice memo

Use the camera's microphone to record voice memos for pictures.



- The recording screen is displayed for a picture without voice memo, while the voice memo playback screen is displayed for a picture with voice memo (a picture marked with  in full-frame playback mode).

Recording Voice Memos

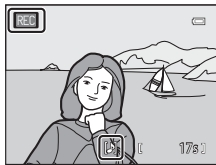
- Voice memo can be recorded for up to about 20 seconds while the  button is pressed.
- Do not touch the microphone during recording.
- During recording, **REC** and  flash on the monitor.
- When recording ends, the voice memo playback screen is displayed.





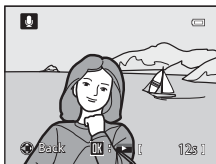

Playing Voice Memos

- Press the  button to play back a voice memo. To end playback, press the  button again.
- Rotate the zoom control toward **T** or **W** during playback to adjust playback volume.
- Press the multi selector  before or after playing a voice memo to return to the playback menu. Press the MENU button to exit the playback menu.



Deleting Voice Memos

Press the  button on the voice memo playback screen. Press the multi selector  or  to select **Yes** and press the  button to delete only the voice memo.





Notes on Voice Memos

- When a picture with a voice memo attached is deleted, both the picture and its voice memo are deleted.
- Voice memos cannot be recorded for a picture that already has a voice memo attached to it. The current voice memo must be deleted before a new voice memo can be recorded.
- Voice memos cannot be attached to pictures taken with cameras other than COOLPIX P7700.
- Voice memos of the images with the **Protect** setting (64) cannot be deleted.
- Voice memos cannot be attached to pictures taken using Easy panorama.

More Information

See "File and Folder Names" (100) for more information.

☒ Copy (Copy Between Internal Memory and Memory Card)

Press the  button (Playback mode) → MENU button (10) → ☒ Copy



Copy pictures or movies between the internal memory and a memory card.

1 Use the multi selector to select an option from the copy screen, and press the button.

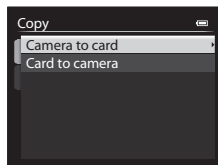
- **Camera to card:** Copy pictures from the internal memory to the memory card.
- **Card to camera:** Copy pictures from the memory card to the internal memory.







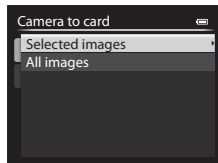

2 Select a copy option and press the button.

- **Selected images:** Copy pictures selected from the image selection screen (95). If a sequence for which only a key picture is displayed is selected (8), all pictures in the displayed sequence are copied.
- **All images:** Copy all pictures. If a picture in a sequence is selected, this option is not displayed.
- **Current sequence:** This option is displayed when a picture in a sequence has been selected before displaying the playback menu. All pictures in the current sequence are copied.



☑ Notes on Copying Pictures

- JPEG-, NRW-, MOV-, WAV-, and MPO-format files can be copied. Files recorded in any other format cannot be copied.
- **Voice memo** (65) attached to pictures and **Protect** setting (64) are also copied with the pictures.
- When images saved with an **Image quality** (75) setting of **NRW (RAW) + Fine** or **NRW (RAW) + Normal** are chosen, the NRW (RAW) and JPEG images are copied at the same time.
- Pictures recorded with another make or model of camera or that have been modified on a computer cannot be copied.
- **Print order** settings (60) are not copied with the pictures.
- If **Sequence display options** (67) is set to **Key picture only** and a picture in the sequence is selected and the  button is pressed to display individual pictures (8), only **Card to camera** image copy is available.

 Message: “Memory contains no images.”



If there are no pictures stored on the memory card when playback mode is selected, the message, the **Memory contains no images.**, is displayed. Press the **MENU** button and select **Copy** from the playback menu to copy the pictures stored in the camera's internal memory to the memory card.

 More Information

See “File and Folder Names” (100) for more information.

 Sequence Display Options



Press the  button (Playback mode) → **MENU** button (10) →  Sequence display options



Choose the method used to display a series of pictures shot continuously (sequence, 8) when viewing them in full-frame playback mode (32) or in thumbnail playback mode (92).

Settings are applied to all sequences, and the setting is saved in the camera's memory even if the camera is turned off.

Option	Description
Individual pictures	Each picture in a sequence is displayed.
Key picture only (default setting)	Return a sequence in which pictures are displayed individually to the key picture only display.

 Choose Key Picture

Press the  button (Playback mode) → Select the desired sequence → **MENU** button (10) →  Choose key picture

When **Sequence display options** is set to **Key picture only**, the key picture displayed in full-frame playback mode (32) or thumbnail playback mode (92) can be set for each sequence of pictures.

- When changing this setting, before pressing **MENU**, first select the desired sequence using full-frame playback mode or thumbnail playback mode.
- When the key picture selection screen is displayed, select a picture. See “Using the Screen for Selecting Images” (95) for more information.

The Setup Menu

Welcome Screen

Press the **MENU** button → **Y** tab (📖10) → Welcome screen

Select whether or not to display the welcome screen on the monitor when the camera is turned on.

Option	Description
None (default setting)	Display the shooting or playback screen without displaying the welcome screen.
COOLPIX	Display the welcome screen before displaying the shooting or playback screen.
Select an image	Select a picture taken to display as the welcome screen. Display the image selection screen, choose an image (📖95), and press the OK button to register it. <ul style="list-style-type: none">• Because the selected image is stored in the camera, the image appears in the welcome screen even if the original image is deleted.• The following pictures cannot be registered.<ul style="list-style-type: none">- NRW (RAW) images- Pictures taken with Image size (📖77) of 16:9 3968×2232, 4:3 3984×2656 or 1:1 3000×3000- Pictures reduced to 320 × 240 or smaller using small picture editing (🔍15) or crop (🔍18)- Pictures taken with Easy panorama- Pictures taken using 3D photography

Time Zone and Date

Press the MENU button → Y tab (📖10) → Time zone and date

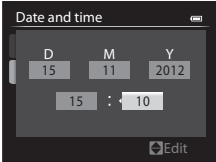
Option	Description
Date and time	<p>Set the camera clock to the current date and time. Use the multi selector to set the date and time.</p> <ul style="list-style-type: none"> Choose an item: Press ► or ◀ (selected in the following order: D (day) → M (month) → Y (year) → hour → minute). Set the contents: Press ▲ or ▼. Date and time can also be set by rotating the multi selector or main command dial. Finish setting: Choose minute and press the OK button or ►. 
Date format	<p>Choose the order in which the day, month, and year are displayed (Year/Month/Day, Month/Day/Year or Day/Month/Year).</p>
Time zone	<p>🏠 Home time zone can be specified and daylight saving can be enabled or disabled. When ➡ travel destination is registered, the time difference from the 🏠 home time zone is automatically calculated and the local date and time are recorded. Useful when traveling.</p>

Setting the Travel Destination Time Zone

1 Use the multi selector to choose **Time zone**, and press the **OK** button.

- The **Time zone** screen is displayed.

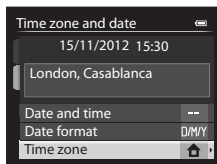

2 Choose **Travel destination** and press the **OK** button.

- The date and time displayed on the monitor change according to the region currently selected.

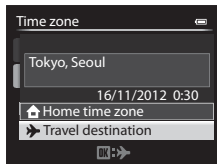

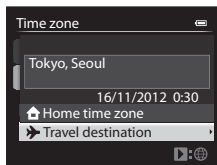

3 Press **▶**.

- The time zone selection screen is displayed.



4 Press **◀** or **▶** to choose the travel destination (Time zone).

- The time difference between home and the travel destination is displayed.
- In regions where daylight saving time applies, press **▲** to enable the daylight saving time function. When this function is set to on, the  icon will be displayed at the top of the monitor and the camera clock advances one hour. To disable the daylight saving time function, press **▼**.
- If the time difference cannot be selected, set the correct time using **Date and time**.
- Press the **OK** button to register the travel destination time zone.
- While the travel destination time zone is selected, the  icon is displayed on the monitor when the camera is in shooting mode.

Time difference

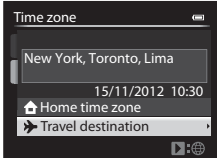
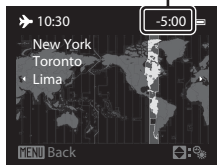







📌 **Home Time Zone**

- To switch to the home time zone, choose **Home time zone** in step 2 and press the **OK** button.
- To change the home time zone, choose **Home time zone** in step 2 and perform the same procedure as for **Travel destination** to set the home time zone.

Monitor Settings

Press the MENU button → Y tab (📖10) → Monitor settings

Option	Description
Image review	<p>On (default setting): Picture is displayed on the monitor immediately after shooting and the monitor display returns to shooting screen.</p> <p>Off: Picture is not displayed after shooting.</p> <p>Tone level information: Tone level information (📖9) is displayed on the monitor immediately after shooting.</p>
Brightness	Choose from 5 settings to select the monitor brightness. The default setting is 3 .
Photo info	<p>Select the display options that are displayed on the monitor screen during shooting. Separate display options (📖12) can be selected for when the monitor screen (📖9) is set to Show info and when it is set to Hide info. In the default setting, all options are hidden.</p> <p> Virtual horizon: Display the virtual horizon for checking whether the camera is horizontal. When the camera is horizontal or vertical, the mark on the virtual horizon display turns green.</p> <p> Histograms: Display a graph that shows the brightness distribution in the picture (📖12).</p> <p> Framing grid: Display a boxed guide for framing.</p> <ul style="list-style-type: none"> To select show or hide, choose an option with the multi selector, and then press the  button to turn the check box on  or off. After finishing the setting, choose Confirm and press the  button.
Virtual horizon display	Set the virtual horizon indicator to either Circle (default setting) or Bars (📖12).

Notes on Photo Info

- The histogram is not displayed during movie recording. The virtual horizon is displayed only before recording is started.
- The virtual horizon is not displayed in the following scene modes.
Scene auto selector, Portrait, Night portrait, Food, Panorama, Pet portrait and 3D photography
- The virtual horizon and histogram may not be displayed when shooting with some of the settings of **Smile timer** or **AF area mode**. See 📖81 for more information.
- In shooting modes **U1, U2** and **U3**, **Photo info** in the setup menu settings cannot be set. Select the **U1, U2** or **U3** tab and set **Photo info** in the specialized menus for **U1, U2** and **U3** (📖73).

Print Date (Imprinting Date and Time on Pictures)

Press the **MENU** button → **Y** tab (📖10) → **Print date**

The shooting date and time can be imprinted on pictures at the time of shooting. This information can be printed even from printers that do not support printing of the date (🔍61).



Option	Description
DATE Date	The date is imprinted on pictures.
DATE Date and time	The date and time are imprinted on pictures.
OFF Off (default setting)	The date and time are not imprinted on pictures.

The icon for the current setting other than **Off** is displayed on the monitor (📖12).

✓ Notes on Print Date

- Imprinted date and time cannot be deleted from the image, nor can date and time be imprinted after the picture has been taken.
- Date and time cannot be imprinted in the following situations.
 - When the scene mode is set to **Easy panorama**, **Panorama assist** or **3D photography**
 - When **Image quality** (📖75) is set to **NRW (RAW)**, **NRW (RAW) + Fine** or **NRW (RAW) + Normal**
 - When **Continuous H: 120 fps** or **Continuous H: 60 fps** is selected for **Continuous** (🔍44)
 - During movie recording
- Dates imprinted with an **Image size** (📖77) setting of **VGA 640×480** may be difficult to read. Set the image size to **1600×1200** or higher.
- The date is recorded using the format selected in the setup menu's **Time zone and date** option (📖24, 🔍69).

🔪 Print Date and Print Order

When printing from DPOF-compatible printers which support printing of shooting date and shooting information, the date and information can be printed on pictures without the date and time being imprinted on them with **Print date**, using options in the **Print order** menu (🔍60).

Self-timer: After Release

Press the MENU button → Y tab (📖10) → Self-timer: after release

Set whether or not to cancel the self-timer mode (📖59), or 10-second, 2-second or 1-second remote mode (📖104), after shooting pictures.

Option	Description
Exit self-timer mode (default setting)	Cancel the self-timer mode after shooting pictures. <ul style="list-style-type: none"> The setting is not canceled in the quick-response remote or smile timer mode (📖60).
Stay in self-timer mode	Enable shooting continuously without canceling the setting, after shooting pictures. <ul style="list-style-type: none"> The setting is cancelled when the camera is turned off.

Vibration Reduction

Press the MENU button → Y tab (📖10) → Vibration reduction

Option	Description
 On (default setting)	Compensate camera shake that commonly occurs when shooting at the telephoto zoom position or slow shutter speed. Camera shake is also compensated when recording movies as well as when shooting still images. The camera automatically detects the panning direction and only compensates for vibration caused by camera shake. When the camera is panned horizontally, for example, vibration reduction only reduces vertical shake. If the camera is panned vertically, vibration reduction only compensates for horizontal shake.
OFF Off	Vibration reduction is not enabled.

- When using a tripod to stabilize the camera, set vibration reduction to **Off**. When **On** is selected, an icon for this setting is displayed on the monitor (📖12).

📌 Notes on Vibration Reduction

- After the power is turned on or the camera enters shooting mode from playback mode, wait until the monitor screen stabilizes before shooting.
- Due to the characteristics of the vibration reduction function, images displayed on the monitor screen immediately after shooting may appear blurry.
- Vibration reduction may be unable to completely eliminate the effects of camera shake in some situations.
- When the **Night landscape** scene mode is set to **Tripod**, or **Zoom exposure** or **Defocus during exposure** is selected in special effects mode, vibration reduction is not performed even if **Vibration reduction** is set to **On**.

AF Assist

Press the **MENU** button → **Y** tab (📖10) → **AF assist**

Enable or disable the AF-assist illuminator that assists the autofocus when the lighting is dim.

Option	Description
Auto (default setting)	<p>AF-assist illuminator lights automatically if the lighting is dim. The illuminator has a range of about 4.0 m (13 ft) at the maximum wide-angle position and about 2.0 m (6 ft 6 in.) at the maximum telephoto position.</p> <ul style="list-style-type: none"> For some focus areas and scene modes such as Museum (📖39) and Pet portrait (📖42), AF-assist illuminator does not turn on even if Auto is set.
Off	AF-assist illuminator does not light. The camera may be unable to focus if lighting is dim.

✔ Note on the AF-assist Illuminator

In shooting modes **U1**, **U2** and **U3**, **AF assist** in the setup menu settings cannot be set. Select the **U1**, **U2** or **U3** tab and set **AF assist** in the specialized menus for **U1**, **U2** and **U3** (📖73).

ISO Sensitivity Step Value

Press the **MENU** button → **Y** tab (📖10) → **ISO sensitivity step value**











Change the step value of the sensitivity to be set for **ISO sensitivity** (🔑31) of the quick menu.

Option	Description
1 step (default setting)	<p>The ISO sensitivity step value is set to 1 step.</p> <ul style="list-style-type: none"> 80, 100, 200, 400, 800, 1600, 3200, Hi 1 (equivalent to ISO 6400)
1/3 step	<p>The ISO sensitivity step value is set to 1/3 step.</p> <ul style="list-style-type: none"> 80, 100, 125, 160, 200, 250, 320, 400, 500, 640, 800, 1000, 1250, 1600, 2000, 2500, 3200, Hi 1 (equivalent to ISO 6400)

Digital Zoom

Press the MENU button → Y tab (📖10) → Digital zoom

Enable or disable the digital zoom.

Option	Description
On (default setting)	When the camera is zoomed in to the maximum optical zoom position, rotating and holding the zoom control toward T (📖9) triggers the digital zoom (📖29).
Crop	<p>Limit zoom magnification up to the  mark position of the zoom indicator. Also limit digital zoom to a range in which the image quality of the pictures to be shot does not deteriorate (📖29).</p> <ul style="list-style-type: none"> The digital zoom is not available when the image size is  4000×3000,  3264×2448,  3984×2656,  3968×2232 or  3000×3000. The digital zoom is not available when the movie options setting is  HD 1080p★ (1920×1080),  HD 1080p (1920×1080),  HS 120 fps (640×480),  HS 60 fps (1280×720) or  HS 15 fps (1920×1080). The digital zoom is not available when Continuous H: 120 fps or Continuous H: 60 fps is selected for Continuous.
Off	The digital zoom is not activated.

Notes on Digital Zoom

- When the digital zoom is used, the focus will be at the center of the frame.
- The digital zoom cannot be used when **Scene auto selector**, **Portrait**, **Night portrait**, **Easy panorama** in **Panorama**, **Pet portrait** or **3D photography** is selected in scene mode.
- The digital zoom cannot be used when **Zoom exposure** is selected in special effects mode.
- Some features cannot be used in combination with other menu settings. See “Features Not Available in Combination” (📖79) for more information.
- When the digital zoom is in effect, **Metering** (📖43) is set to **Center-weighted** or **Spot** depending on the magnification of an enlargement.

Zoom Speed

Press the MENU button → Y tab (📖10) → Zoom speed

Set the zoom operation speed. Slow down the zoom speed to minimize the recording of the zoom operating noise during movie recording.

Option	Description
Auto (default setting)	During still picture shooting, operate the zoom at the Normal speed. During movie recording, operate the zoom at a lower speed than Normal to minimize the recording of the zoom operating noise.
Normal	During both still picture shooting and movie recording, operate the zoom at the standard speed. During both still picture shooting and movie recording, rotating the zoom control all the way in either direction adjusts the zoom quickly, while rotating the control partially adjusts the zoom slowly.
Quiet	During both still picture shooting and movie recording, operate the zoom at a lower speed than Normal .

The icon for the current setting other than **Auto** is displayed on the monitor (📖12).

Fixed Aperture

Press the MENU button → Y tab (📖10) → Fixed aperture

Option	Description
On	In A or M shooting mode, zooming can be performed with minimum changes in the aperture value. <ul style="list-style-type: none"> When the f-number exceeds the aperture control range at a new zoom position, the aperture value is not fixed.
Off (default setting)	The aperture value is not fixed.

More Information

See "Aperture Value (F-number) and Zoom" (📖49) for more information.

Sound Settings

Press the MENU button → Y tab (📖10) → Sound settings

Adjust the following sound settings.

Option	Description
Button sound	Set the following all sound settings to On (default setting) or Off . <ul style="list-style-type: none"> • Setting beep (beep sounds once when the settings are completed) • Focus beep (beep sounds twice when the camera focuses on the subject) • Error beep (beep sounds three times when an error is detected) • Start-up sounds to be emitted when the camera is turned on. (No sound is emitted when Welcome screen is set to None.)
Shutter sound	Choose whether to set the shutter sound to On (default setting) or Off .

✔ Notes on Sound Settings

- In **Pet portrait** scene mode, even when **On** is set, the button sound and shutter sound are disabled.
- Even when **On** is set, the shutter sound is disabled during movie recording.
- Some features cannot be used in combination with other menu settings. See “Features Not Available in Combination” (📖79) for more information.

Record Orientation

Press the MENU button → Y tab (📖10) → Record orientation

Option	Description
Auto (default setting)	The orientation data is recorded with the taken picture. When played back while Rotate tall (📷78) is set to On , the picture is automatically rotated for display.
Off	The orientation data is not recorded and pictures are always recorded with landscape orientation.

- The orientation data can be changed after shooting using **Rotate image** in the playback menu (📷64).

✔ Notes on Recording the Orientation Data

- In **Continuous** or **Auto bracketing** mode, all pictures are recorded with the same orientation data as the first picture.
- Correct orientation data may not be obtained for pictures recorded with the camera facing up or down.

Rotate Tall

Press the MENU button → Y tab (📖10) → Rotate tall

Option	Description
On (default setting)	When the orientation of the camera is changed during playback, the displayed images are rotated in accordance with the "tall" orientation data recorded with the picture.
Off	The image will not be rotated even if the camera's orientation is changed.



Auto Off

Press the MENU button → Y tab (📖10) → Auto off

If no operations are performed for a certain period while the camera is on, the monitor is turned off to save power and the camera enters standby mode (📖23). In this menu, set the time before the camera enters standby mode.

Choose from **30 s**, **1 min** (default setting), **5 min** and **30 min**.

Auto Off Setting

- In the following situations, the time taken for the camera to enter standby mode is fixed.
 - When menus are displayed: 3 minutes (when auto off is set to **30 s** or **1 min**.)
 - During slideshow playback: maximum of 30 minutes
 - When the AC Adapter EH-5b is connected: 30 minutes
- The camera does not enter standby mode when transferring images using the Eye-Fi card.

Format Memory/Format Card

Press the MENU button → Y tab (📖10) → Format memory/Format card

Format the internal memory or a memory card.

Formatting permanently deletes all data in the internal memory or memory card. The deleted data cannot be recovered. Be sure to transfer important pictures to a computer before formatting.

Formatting the Internal Memory

To format the internal memory, remove the memory card from the camera. The

Format memory option is displayed on the setup menu.

Formatting Memory Cards

When a memory card is inserted in the camera, the memory card can be formatted.

The **Format card** option is displayed on the setup menu.

Formatting Internal Memory and Memory card

- Do not turn off the camera or open the battery-chamber/memory card slot cover during formatting.
- The first time you insert a memory card that has been used in another device into this camera, be sure to format it with this camera.

Language

Press the MENU button → Y tab (📖10) → Language

Choose one of 31 languages for displaying the camera menus and messages.

Čeština	Czech
Dansk	Danish
Deutsch	German
English	(default setting)
Español	Spanish
Ελληνικά	Greek
Français	French
Indonesia	Indonesian
Italiano	Italian
Magyar	Hungarian

Nederlands	Dutch
Norsk	Norwegian
Polski	Polish
Português (BR)	Brazilian Portuguese
Português (PT)	Portuguese
Русский	Russian
Română	Romanian
Suomi	Finnish
Svenska	Swedish
Tiếng Việt	Vietnamese

Türkçe	Turkish
Українська	Ukrainian
عربي	Arabic
简体中文	Simplified Chinese
繁體中文	Traditional Chinese
日本語	Japanese
한국	Korean
ภาษาไทย	Thai
हिन्दी	Hindi
বাংলা	Bengali
தமிழ்	Tamil

TV Settings

Press the **MENU** button → **Y** tab (📖10) → TV settings

Adjust the settings for connecting to a TV.

Option	Description
Video mode	Select the analog video output system from NTSC or PAL in accordance with your TV.
HDMI	Select a picture resolution for HDMI output from Auto (default setting), 480p , 720p , or 1080i . When Auto is set, the output resolution that is best suited to the connected TV is selected automatically from 480p , 720p or 1080i .
HDMI device control	Select whether or not the camera receives signals from a TV when a TV that conforms to the HDMI-CEC standard is connected with an HDMI cable. When set to On (default setting), the television remote control can be used to operate the camera during playback. See "Using the TV's Remote Control (HDMI Device Control)" (📖20) for more information.
HDMI 3D output	Set the method used to output 3D images to HDMI devices. Select On (default setting) to three-dimensionally play back 3D images taken with this camera on a TV or monitor that is connected via HDMI.

External Mic Sensitivity

Press the **MENU** button → **Y** tab (📖10) → External mic sensitivity

Set the external microphone sensitivity to **Auto** (default setting), **High**, **Medium** or **Low** when recording movies.

When the microphone sensitivity is set to **Auto**, the camera automatically adjusts the microphone sensitivity.

Customize Command Dials

Press the MENU button → Y tab (10) → Customize command dials

Swap the function of the main command dial for that of the sub-command dial when the exposure is set (48).

- This option is available only when shooting mode is set to **P**, **S**, **A**, **M**, **U1**, **U2** or **U3** mode or during movie custom setting mode (when **Shooting mode** is set to **Aperture-priority auto** or **Manual**).

Option	Description
No swap (default setting)	In P mode, set the flexible program using the main command dial. In S , A or M mode, set the shutter speed using the main command dial and set the aperture value using the sub-command dial.
Swap main and sub	In P mode, set the flexible program using the sub-command dial. In S , A or M mode, set the shutter speed using the sub-command dial and set the aperture value using the main command dial.

Command Dial Rotation

Press the MENU button → Y tab (10) → Command dial rotation

Change the direction of operation when the command dial is rotated during shooting.

- For example, when **Standard rotation** (default setting) is set in **S** mode, the shutter speed is set to the low speed side if the main command dial is rotated counterclockwise. When **Reverse rotation** is set, the shutter speed is set to the high speed side if the main command dial is rotated counterclockwise.
- This option is available only when shooting mode is set to **P**, **S**, **A**, **M**, **U1**, **U2** or **U3** mode or during movie custom setting mode (when **Shooting mode** is set to **Aperture-priority auto** or **Manual**).

Multi Selector Right Press



Press the MENU button → Y tab (10) → Multi selector right press

Set to **Off** if you do not want to display the AF area mode (47) setting when the multi selector ► is pressed.

- The default setting is **AF area mode**.

Delete Button Options

Press the MENU button → Y tab (📖10) → Delete button options

Option	Description
Press twice to delete	Press the  button once more to delete an image while the deletion confirmation message is displayed (📖33).
Disable second press (default setting)	Even if the  button is pressed again while the deletion confirmation message is displayed, the image is not deleted.

AE/AF Lock Button

Press the MENU button → Y tab (📖10) → AE/AF lock button

Select the function to be performed when the AE-L/AF-L (AE-L/AF-L) button (📖4) is pressed while shooting.

Option	Description
AE/AF lock (default setting)	Lock both the focus and exposure while the AE-L/AF-L (AE-L/AF-L) button is pressed.
AE lock only	Lock only the exposure while the AE-L/AF-L (AE-L/AF-L) button is pressed.
AE lock (Hold)	Lock the exposure when the AE-L/AF-L (AE-L/AF-L) button is pressed and retain this exposure setting. To cancel the setting, press the button again.
AF lock only	Lock only the focus while the AE-L/AF-L (AE-L/AF-L) button is pressed.

The AE-L/AF-L (AE-L/AF-L) button setting is displayed on the monitor during shooting (📖12).

- See “Focus and Exposure During Movie Recording” (📖102) for more information on the operation when the AE-L/AF-L (AE-L/AF-L) button is pressed during movie recording.

✓ Notes on AE/AF Lock Button Setting

- When the scene mode is **Scene auto selector**, AF-L (focus locking) using the AE-L/AF-L (AE-L/AF-L) button is disabled. When the scene mode is **Fireworks show**, the AE-L/AF-L (AE-L/AF-L) button cannot be used.
- AE-L (exposure locking) cannot be used when the shooting mode is set to **M**.
- AF-L (focus locking) cannot be used when focus mode (📖62) is set to **MF** (manual focus).

📎 More Information

See “Focus Lock” (📖86) for more information.

Fn1 + Shutter Button

Press the MENU button → Y tab (📖10) → Fn1 + shutter button

Set the function to be performed when the shutter-release button is pressed while pressing the **Fn1** (function 1) button (📖4) during shooting.

- This can be used when **P, S, A, M, U1, U2** or **U3** is chosen for shooting mode.

Option	Description
Off (default setting)	Shoot without changing the setting.
NRW (RAW)/NORMAL (Image quality) (📖75)	When Fine or Normal is set, shoot with the NRW (RAW) setting. When NRW (RAW) is set, shoot with the Normal setting. <ul style="list-style-type: none"> • The image size is  4000×3000. • When NRW (RAW) + Fine or NRW (RAW) + Normal is set, shoot without changing the setting.
ISO sensitivity (📷31)	Shoot with ISO sensitivity set to Auto .
White balance (📷33)	Shoot with White balance set to Auto (normal) . <ul style="list-style-type: none"> • Cannot be used when Picture Control is set to Monochrome.
Picture Control (📷38)	Shoot with COOLPIX Picture Control set to Standard .

Fn1 + Command Dial/Fn1 + Selector Dial

Press the MENU button → Y tab (10) → Fn1 + command dial/Fn1 + selector dial

Set the function to be performed when the command dial or multi selector is rotated while pressing the **Fn1** (function 1) button during shooting.

- Rotating either the main command dial or sub-command dial enables the command dial operation.
- This option is available when the shooting mode is **P, S, A, M, U1, U2, U3** or movie custom setting mode.

Option	Description
Off (default setting)	Shoot without the function. Operation will be disabled.
Metering (43)	Change the setting for metering.
Continuous (44)	Change the settings for continuous shooting.
Flash exp. comp. (51)	Change the setting for Flash exp. comp.
Active D-Lighting (53)	Change the setting for Active D-Lighting.
ISO sensitivity (31)	Change the setting for ISO sensitivity.
White balance (33)	Change the setting for white balance. <ul style="list-style-type: none"> • This option is not available for Measure and Fine-tune in the Preset manual menus.
Picture Control (38)	Change the setting for COOLPIX Picture Control. <ul style="list-style-type: none"> • This option is not available for Quick adjust and manual adjust.
Vibration reduction (73)	Change the setting for vibration reduction.

Note on Fn1 + Command Dial/Fn1 + Selector Dial

Operation is disabled when AE or AF is locked.

F_n1 Guide Display

Press the MENU button → Y tab (📖10) → F_n1 guide display

Option	Description
On (default setting)	When the F_n1 (function 1) button is pressed during shooting, a guide for the functions assigned to the F_n1 + shutter button (🔍83), F_n1 + command dial and F_n1 + selector dial (🔍84) is displayed on the monitor screen. <ul style="list-style-type: none"> In the shooting modes or settings during which the F_n1 button cannot be used, 📷 will be displayed.
Off	Even if the F_n1 button is pressed, guide is not displayed.

F_n2 Button

Press the MENU button → Y tab (📖10) → F_n2 button

Choose the function to be performed when the **F_n2** button (📖4) is pressed while shooting.

Option	Description
Off (default setting)	Shoot without the function. Operation will be disabled.
Virtual horizon, View/hide histograms, View/hide framing grid	Select whether to view or hide the virtual horizon, histogram or framing grid displays (🔍71) on the monitor screen during shooting.
Built-in ND filter	Change the built-in ND filter (🔍52) setting.

Customize My Menu

Press the **MENU** button → **Y** tab (10) → Customize My Menu

Register frequently used menu items in My Menu (maximum of 5). The registered My Menu can be displayed when the quick menu dial is set to **My**, allowing quick checks or changes to the settings (only when the shooting mode is set to **P**, **S**, **A**, **M**, **U1**, **U2** or **U3**).

The following items can be registered.

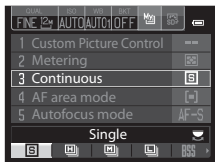

Custom Picture Control (42)	Flash exp. comp. (51)	Digital zoom (75)
Metering (43)	Noise reduction filter (52)	Format memory/Format card (79)
Continuous (44)	Distortion control (53)	Built-in ND filter (52)
AF area mode (47)	Active D-Lighting (53)	Eye-Fi upload (89)
Autofocus mode (51)	Vibration reduction (73)	None (delete)*

* Choose to remove an item from My Menu.

Registering into My Menu

1 Use the multi selector to choose the menu item and press the **OK** button.

- The menu item selection screen is displayed.

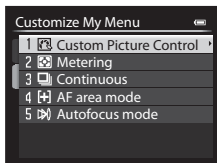

2 Choose the menu item to be registered and press the **OK** button.

- The chosen menu item is switched.
- To finish the setting, press the multi selector ◀.

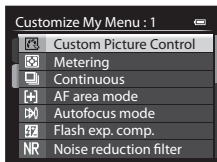

Reset File Numbering

Press the **MENU** button → **Y** tab (📖10) → Reset file numbering

When **Yes** is selected, the sequential numbering of file numbers is reset (🔍100). After resetting, a new folder is created and the file number for the next picture taken starts from "0001."

✔ Note on Reset File Numbering

Reset file numbering cannot be applied when the folder number reaches 999 and there are images in the folder. Insert a new memory card, or format the internal memory/memory card (🔍79).

GPS Options

Press the **MENU** button → **Y** tab (📖10) → GPS options

Set this option when the GPS Unit (available separately) is connected. This setting is enabled when the GPS Unit (available separately) (🔍102) is connected to the accessory terminal (📖2).

Option	Description
Record GPS data	When set to On (default setting), signals are received from the GPS satellites and positioning starts. The position information (latitude and longitude) can be recorded on the pictures to be shot (🔍88). <ul style="list-style-type: none"> Set Time zone and date (🔍69) correctly before using the GPS function.
Synchronize	Signals from the GPS satellites are used to set the date and time of the camera's internal clock (only when Record GPS data is set to On). Check the positioning status before starting synchronize.

✔ Notes on Synchronize

- Date/time adjustment by **Synchronize** is set according to the time zone set in **Time zone and date** (📖24, 🔍69) of the setup menu. Check the time zone before setting **Synchronize**.
- The date/time set using **Synchronize** is not as accurate as radio clocks. Use **Time zone and date** in the setup menu to set the time if it is not accurate in **Synchronize**.

Recording GPS Data on Pictures

When the GPS Unit (available separately) is connected, signals from GPS satellites are received and the current position information (latitude and longitude) can be calculated and recorded on the pictures to be shot.

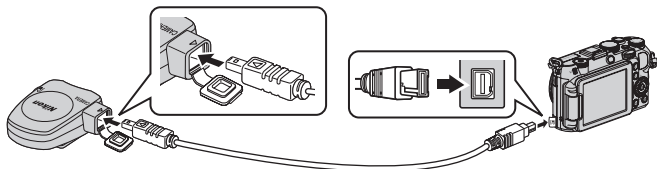

- Make sure to insert the plug in the correct direction. Inserting the plug in the wrong direction could damage the plug or connector.
- To use the built-in flash, do not attach the GPS Unit to the accessory shoe.
- To start recording the location information, set **Record GPS data** in **GPS options** to **On** (default setting) (087).
- Operate in an open-air area when starting to receive signals from GPS satellites.

GPS Reception Indicator

GPS reception can be checked on the shooting screen.

- : Signals are being received from four or more satellites and determine position. Position information is recorded on the image.
- : Signals are being received from three satellites and determine position. Position information is recorded on the image.
- : Signals are being received from the satellite, but positioning is not possible. The position information recorded last is recorded on the image.
- : Signals cannot be received from the satellite, and positioning is not possible. The position information is not recorded on the image.

GPS reception

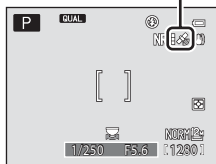

Pictures with Recorded Position Information

- The icon is displayed during playback for images which have the position information recorded (14).
- Position information recorded on a picture can be checked on a map with ViewNX 2 after transferring the image to a computer (97).
- The actual place of shooting may differ from the GPS information recorded on the image files due to the accuracy of the position information obtained and a difference in the geodetic system used.

Notes on GPS

- Be aware of your surroundings when positioning.
- The date and time of the camera's internal clock at the time of shooting is recorded at the date and time of recording indicators displayed on the camera during playback. The time obtained by the GPS Unit and recorded on images will not be displayed on the camera.
- Position information will be recorded on the first frame of pictures shot using continuous shooting mode.

Note on Pictures with Recorded Position Information

An individual may be identified from still pictures that have been recorded with location information. Observe caution when you transfer still pictures recorded with location information to a third party or upload them to a network such as the Internet where the public can view them.

Eye-Fi Upload

Press the **MENU** button → **Y** tab (📖10) → Eye-Fi upload





Option	Description
Enable (default setting)	Upload images created by the camera to a preselected destination.
Disable	Images will not be uploaded.

Notes on Eye-Fi Cards

- Note that images will not be uploaded if signal strength is insufficient even if **Enable** is selected.
- Select **Disable** where wireless devices are prohibited.
- Refer to the instruction manual of your Eye-Fi card for more information. In the event of malfunction, contact the card manufacturer.
- The camera can be used to turn Eye-Fi cards on and off, but may not support other Eye-Fi functions.
- The camera is not compatible with the endless memory function. When it is set on a computer, disable the function. If the endless memory function is enabled, the number of pictures taken may not be displayed correctly.
- Eye-Fi cards are for use only in the country of purchase. Observe all local laws concerning wireless devices.
- Leaving the setting as **Enable** will result in the battery being depleted in a shorter period of time.

Eye-Fi Communication Indicator

The communication status of the Eye-Fi card in the camera can be confirmed on the monitor (📖12).

- : **Eye-Fi upload** is set to **Disable**.
-  (lights): Eye-Fi upload enabled; waiting to begin upload.
-  (flashes): Eye-Fi upload enabled; uploading data.
- : An error occurred. The camera cannot control the Eye-Fi card.

MF Distance Indicator Units

Press the MENU button → Y tab (📖10) → MF distance indicator units

Set either **m** (meter) (default setting) or **ft** (feet) for the unit of gauge displayed when the focus mode is set to manual focus (🔍2).

Reverse Indicators

Press the MENU button → Y tab (📖10) → Reverse indicators

Change the +/- display direction of the exposure indicator (📖50) displayed when shooting mode is **M** and the indicator displayed for setting bracketing (🔍36). The - side of the indicators is set to the left and + side is set to the right in the default setting.

Flash Control

Press the MENU button → Y tab (📖10) → Flash control

You can switch the flash to be used.

Option	Description
AUTO Auto (default setting)	When the Speedlight (external flash unit) (📖87) is used, the Speedlight fires. When the Speedlight is not used, the built-in flash fires.
 Optional flash	The built-in flash is always disabled. Only the Speedlight is used.

Note on Flash Control

Some features cannot be used in combination with other menu settings. See "Features Not Available in Combination" (📖79) for more information.

Reset All

Press the MENU button → Y tab (📖10) → Reset all

When **Reset** is selected, the camera settings are restored to the default values.

Pop-up Menu

Option	Default value
Flash mode (📖56)	Auto
Self-timer (📖59)/Smile timer (📖60)/ Remote control (🔌104)	OFF
Focus mode (📖62)	Autofocus

Shooting in the Scene Mode

Option	Default value
Scene menu (📖35)	Scene auto selector
Night landscape (📖38)	Hand-held
Hue adjustment in Food mode (📖39)	Center
HDR in Backlighting (📖40)	Off
Panorama (📖41)	Normal (180°) in Easy panorama
Pet portrait (📖42)	Pet portrait auto release: ON Continuous: Continuous



Special Effects Menu

Option	Default value
Special effects (📖45)	Creative monochrome

Movie Menu/Custom Movie Menu

Option	Default value
Shooting mode (🔌58)	Aperture-priority auto
Special effects (🔌58)	Painting
Autofocus mode (🔌59)	Single AF
Built-in ND filter (🔌59)	Off
Wind noise reduction (🔌59)	Off

Quick Menu

Option	Default value
Image quality (📖75)	Normal
Image size (📖77)	 4000×3000
Movie options (🔍28)	 HD 1080p★ (1920×1080)
ISO sensitivity (🔍31)	Auto
Minimum shutter speed (🔍31)	None
White balance (🔍33)	Auto (normal)
Auto bracketing (🔍36)	OFF
Picture Control (🔍38)	Standard

Shooting Menu

Option	Default value
Metering (🔍43)	Matrix
Continuous (🔍44)	Single
Intvl timer shooting (🔍45)	30 s
AF area mode (🔍47)	Center (normal)
Autofocus mode (🔍51)	Single AF
Flash exp. comp. (🔍51)	0.0
Noise reduction filter (🔍52)	Normal
Built-in ND filter (🔍52)	Off
Distortion control (🔍53)	Off
Active D-Lighting (🔍53)	Off
Zoom memory (🔍54)	All values are chosen
Startup zoom position (🔍54)	28 mm
M exposure preview (🔍55)	Off
Focus-coupled metering (🔍55)	On
Commander mode (🔍56)	Flash mode: Standard flash Flash control mode: TTL

Setup Menu

Option	Default value
Welcome screen (🔍68)	None
Image review (🔍71)	On
Brightness (🔍71)	3

Option	Default value
Photo info (Fn71)	Hide all items
Virtual horizon display (Fn71)	Circle
Print date (Fn72)	Off
Self-timer: after release (Fn73)	Exit self-timer mode
Vibration reduction (Fn73)	On
AF assist (Fn74)	Auto
ISO sensitivity step value (Fn74)	1 step
Digital zoom (Fn75)	On
Zoom speed (Fn76)	Auto
Fixed aperture (Fn76)	Off
Button sound (Fn77)	On
Shutter sound (Fn77)	On
Record orientation (Fn77)	Auto
Rotate tall (Fn78)	On
Auto off (Fn78)	1 min
HDMI (Fn80)	Auto
HDMI device control (Fn80)	On
HDMI 3D output (Fn80)	On
External mic sensitivity (Fn80)	Auto
Customize command dials (Fn81)	No swap
Command dial rotation (Fn81)	Standard rotation
Multi selector right press (Fn81)	AF area mode
Delete button options (Fn82)	Disable second press
AE/AF lock button (Fn82)	AE/AF lock
Fn1 + shutter button (Fn83)	Off
Fn1 + command dial (Fn84)	Off
Fn1 + selector dial (Fn84)	Off
Fn1 guide display (Fn85)	On
Fn2 button (Fn85)	Off
Customize My Menu (Fn86)	1: Custom Picture Control 2: Metering 3: Continuous 4: AF area mode 5: Autofocus mode
Record GPS data (Fn87)	On

The Setup Menu

Option	Default value
Eye-Fi upload (0089)	Enable
MF distance indicator units (0090)	m
Reverse indicators (0090)	-0+
Flash control (0090)	Auto

Others

Option	Default value
Paper size (0022, 23)	Default
Frame intvl for Slide show (0062)	3 s
Sequence display options (0067)	Key picture only

- Choosing **Reset all** also clears the current file number (00100) in the memory. After resetting, numbering continues from the lowest number available in the internal memory or the memory card. If **Reset all** is performed after all pictures are deleted from the internal memory or memory card (0063), the file numbers for the next pictures taken start from "0001."
- The following settings remain unaffected even if **Reset all** is performed.
 - Quick menu:** Preset manual data for **White balance** (0035)
 - Shooting menu: Custom Picture Control** registration (0042)
 - Setup menu: Time zone and date** (0069), **Language** (0079) and **Video mode** (0080) in **TV settings**
- User settings that were saved for mode dial **U1**, **U2** and **U3** are not reset to the default settings when **Reset all** is performed. To change these settings back to the default settings, use **Reset user settings** (0073).

Firmware Version



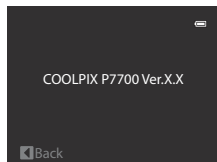

Press the **MENU** button → **Y** tab (0010) → **Firmware version**

Displays the current camera firmware version.

















Error Messages

The following table lists the error messages and other warnings displayed on the monitor, as well as the solutions for dealing with them.



Display	Cause/Solution	
 (flashes)	Clock not set. Set date and time.	 69
Battery exhausted.	Battery exhausted. Charge or replace the battery.	16, 18
Battery temperature high	Battery temperature is high. Turn off camera, and allow battery to cool down before resuming use. Five seconds after this message appears, the monitor is turned off, and the power-on lamp starts flashing quickly. After the lamps flash for three minutes, the camera turns off automatically, but you can also press the power switch to turn it off manually.	23
The camera will turn off to prevent overheating.	Inside of the camera has become hot. The camera turns off automatically. Leave the camera off until the inside of the camera has cooled and then turn it on again.	–
 (flashes red)	Camera cannot focus. <ul style="list-style-type: none"> • Refocus. • Use focus lock. 	30 86
Please wait for the camera to finish recording.	Camera cannot perform other operations until recording is complete. Wait until message clears from display automatically when recording is complete.	–
Memory card is write protected.	Write-protect switch of the memory card is in “lock” position. Slide the write-protect switch to “write” position.	–
Not available if Eye-Fi card is locked.	Write-protect switch of Eye-Fi card is in “lock” position. Slide the write-protect switch to “write” position.	–
	Error accessing Eye-Fi card. <ul style="list-style-type: none"> • Check that the terminal is clean. • Confirm that memory card is correctly inserted. 	20 20
This card cannot be used.	Error accessing memory card. <ul style="list-style-type: none"> • Use an approved card. 	21
This card cannot be read.	<ul style="list-style-type: none"> • Check that the terminal is clean. • Confirm that memory card is correctly inserted. 	20
		20









Error Messages

Display	Cause/Solution	
Card is not formatted. Format card? Yes No	Memory card has not been formatted for use in this camera. All data stored on the memory card is deleted when formatted. If there is any data on the card that you want to keep, select No , and backup the data to a computer before formatting the memory card. To format the memory card, select Yes and press the  button.	20
Out of memory.	Memory card is full. <ul style="list-style-type: none"> Choose lower image quality or smaller image size. Delete pictures and movies. Replace memory card. Remove memory card and use internal memory. 	75, 77 33, 109,  63 20 21
Image cannot be saved.	Error occurred while recording picture. Format the internal memory or memory card.	 79
	Camera has run out of file numbers. Replace the memory card, or format the internal memory/memory card.	20,  79
	Picture cannot be used for welcome screen.	 68
	There is insufficient space to save a copy. Delete pictures from destination.	33
Unable to create panorama.	Cannot perform Easy panorama shooting. Easy panorama shooting may not be available in the following situations. <ul style="list-style-type: none"> When shooting has not finished after a certain period of time When the camera movement speed is too fast When the camera is not straight relative to the panorama direction 	 3
Unable to create panorama. Pan the camera in one direction only.		
Unable to create panorama. Pan the camera more slowly.		
Failed to take second shot	When taking 3D images, the second shot could not be successfully taken after the first shot. <ul style="list-style-type: none"> Try shooting again. After taking the first shot, move the camera horizontally and frame the subject so that it is aligned with the guide. In some shooting conditions, such as when the subject moves or the subject is dark or low in contrast, the second shot may not be taken. 	43 –
Failed to save 3D image	Failed to save the 3D images. <ul style="list-style-type: none"> Try shooting again. Delete unnecessary pictures. In some shooting conditions, such as when the subject moves or the subject is dark or low in contrast, the 3D images may not be created, resulting in failure to save them. 	43 33 –

Display	Cause/Solution	
Sound file cannot be saved.	A voice memo cannot be attached to this file. <ul style="list-style-type: none"> Voice memos cannot be attached to a picture taken by Easy panorama or to movies. Select a picture taken with this camera. 	–  65
Image cannot be modified.	Cannot edit selected picture. <ul style="list-style-type: none"> Confirm the conditions that are required for editing. RAW processing cannot be performed for NRW (RAW) pictures that were taken with cameras other than COOLPIX P7700. These options cannot be used with movies. 	 10 – –
Cannot record movie.	Time out error while recording movie. Choose memory card with faster write speed.	21
Cannot reset file numbering.	No more folders can be created. Insert a new memory card, or format the internal memory/memory card.	20,  79
Memory contains no images.	No pictures in the internal memory or memory card. <ul style="list-style-type: none"> To view the pictures stored in the internal memory, remove the memory card. To copy pictures from internal memory to a memory card, press the MENU button and select Copy from the playback menu. 	20  66
File contains no image data.	File not created with COOLPIX P7700. File cannot be viewed on this camera.	–
This file cannot be played back.	View file using the computer or any other devices which was used to create or edit this file.	–
All images are hidden.	No images available for a slide show.	–
This image cannot be deleted.	Picture is protected. Disable protection.	 64
Travel destination is in the current time zone.	Destination in same time zone as home.	–
My Menu can not be changed at current settings.	All registered menu items cannot be changed at the current setting. <ul style="list-style-type: none"> Some features cannot be used in combination with other menu settings. There is no item that can be set using the current shooting mode. Change the menu item to be registered in My Menu. 	79 –  86
Mode dial is not in the proper position.	Mode dial is between two modes. Rotate the mode dial to select the desired mode.	26

Error Messages

Display	Cause/Solution	
Raise the flash.	<ul style="list-style-type: none"> When the scene mode is Scene auto selector, you can take a picture even if the flash is lowered but the flash will not fire. When the scene mode is Night portrait or Backlighting with HDR set to Off, you must raise the flash to take a picture. 	36 37, 40
Speedlight setting error	Refer to the Speedlight or Speedlight commander instruction manual to check the settings.	87,  56
Lens error	Lens error occurred. Turn the camera off and then on again. If the error persists, contact retailer or Nikon-authorized service representative.	23
Communications error	Error occurred during communication with printer. Turn off camera and reconnect the USB cable.	 21
System error	Error has occurred in camera's internal circuitry. Turn off camera, remove and reinsert battery, and turn on camera. If the error persists, contact retailer or Nikon-authorized service representative.	23
Could not obtain GPS data.	The camera clock is not set correctly. Change the location or time and determine the location again.	–

Display	Cause/Solution	
Printer error: check printer status.	Printer error Check printer. After solving the problem, select Resume and press the  button to resume printing.*	–
Printer error: check paper	Specified size of paper is not loaded. Load the specified size of paper, select Resume and press the  button to resume printing.*	–
Printer error: paper jam	Paper has jammed in the printer. Remove the jammed paper, select Resume and press the  button to resume printing.*	–
Printer error: out of paper	No paper is loaded in the printer. Load the specified size of paper, select Resume and press the  button to resume printing.*	–
Printer error: check ink	Ink error Check ink, select Resume and press the  button to resume printing.	–
Printer error: out of ink	Ink cartridge is empty. Replace ink cartridge, select Resume and press the  button to resume printing.	–
Printer error: file corrupt	An error caused by the image file has occurred. Select Cancel and press the  button to cancel printing.	–

* See the instruction manual provided with your printer for further guidance and information.

File and Folder Names

Pictures, movies and voice memos are assigned file names as follows.

File name : DSCN0001.JPG

(1) (2) (3)

(1) Identifier	Not displayed on camera monitor.	
	DSCN	Original still pictures, movies, still pictures extracted from movies
	SSCN	Small copies
	RSCN	Cropped copies
	FSCN	Pictures created with picture editing other than cropping and small picture, movies created with movie editing
(2) File number	Assigned automatically in ascending order, starting from "0001" to "9999." <ul style="list-style-type: none">When the file numbers in a folder reach 9999, a new folder is created and the next file number returns to "0001."	
(3) Extension	Signifies the file type	
	.JPG	JPEG still pictures
	.NRW	RAW still pictures
	.MOV	Movies
	.WAV	Voice memos <ul style="list-style-type: none">Identifier and file number are the same as the picture to which the voice memo is attached.
.MPO	3D images	

Folder name : 100NIKON

(1) (2)

(1) Folder number	Assigned automatically in ascending order, starting from "100" to "999." <ul style="list-style-type: none"> A new folder is created under the following conditions. <ul style="list-style-type: none"> When the number of files in a folder reaches 200 When the file numbers in a folder reach 9999 When Reset file numbering (Fn91) is performed If a folder is empty, a new folder is not created even if Reset file numbering (Fn91) is performed. 	
(2) Folder name	NIKON	Still pictures and movies other than those taken using panorama assist or interval timer shooting
	P_001	Pictures taken using panorama assist <ul style="list-style-type: none"> A new folder is created each time a picture is taken. The pictures are sequentially saved in file numbers starting from 0001.
	INTVL	Pictures taken using interval timer shooting <ul style="list-style-type: none"> A new folder is created each time a picture is taken. The pictures are sequentially saved in file numbers starting from 0001.



Notes

- When images are shot with an **Image quality** (Fn75) setting of **NRW (RAW) + Fine** or **NRW (RAW) + Normal**, the NRW (RAW) and JPEG images that are recorded at the same time are assigned the same identifier and file number. The pair of images is saved in the same folder and is counted as one file.
- When image files or voice files are copied to or from the internal memory or memory card (Fn66), the file naming conventions are as follows:
 - Selected images:
Files copied using selected images are copied to the current folder (or to the folder used for subsequent pictures), where they are assigned file numbers in ascending order following the largest file number in memory.
 - All images:
Files copied using all images, along with their folder, are copied together. Folder numbers are assigned in ascending order, following the largest folder number on the destination medium. File names are not changed.
- When the current folder is numbered 999, if there are 200 files in the folder or if a file is numbered 9999, no further pictures can be shot until the internal memory or memory card is formatted (Fn79), or a new memory card is inserted.

Optional Accessories

See our websites or product catalogs for up-to-date information on accessories for the COOLPIX P7700.

Filter, Lens Hood

- 40.5mm screw-on filter 40.5 NC →  103
- Lens Hood HN-CP17 →  103

Speedlight
(external flash unit),
Wireless Speedlight
Commander →  87



External Microphone →

 104

- Stereo Microphone ME-1

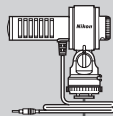

AC Adapter/Power
Connector →  103

- Power Connector EP-5A

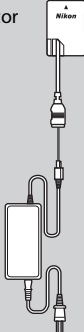

- AC Adapter EH-5b



- Hand Strap AH-CP1

Remote Control,
GPS Accessory



- Remote Control ML-L3 →  104,  105



- Remote Cord MC-DC2



- GPS Unit GP-1 →  88

Attaching AC Adapter EH-5b and Power Connector EP-5A

When the Power Connector is inserted into the camera and the AC Adapter is connected, the camera can be powered from an electrical outlet.

The AC Adapter and the Power Connector are available separately.

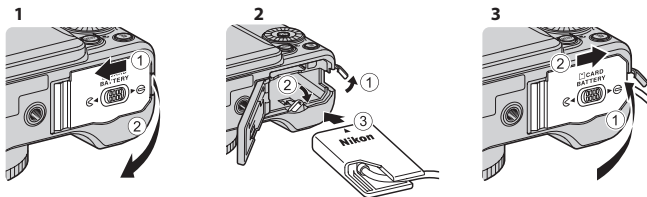

Before closing the battery-chamber/memory card slot cover, fully insert the cord of the power connector into the slot in the battery chamber. If part of the cord runs out of the grooves, the cover or cord may be damaged when the cover is closed.

Insert the DC plug of the AC Adapter EH-5b into the DC plug connector of the Power Connector EP-5A.

Filter

A 40.5mm screw-on filter 40.5 NC can be attached.

Lens Hood

When the Lens Hood HN-CP17 (available separately) is attached, light which adversely affects the image is cut out. The hood also serves to protect the lens surface.

A 58mm screw-on filter can be attached to the lens hood.



✔ Note on the Use of a Commercially Available Step-Up Ring

When a commercially available step-up ring is used, be sure to remove the lens ring (1). Failure to observe this precaution could result in trouble.

- The Lens Hood HN-CP17 can be used without removing the lens ring.

Shooting with Remote Control ML-L3

Use the Remote Control ML-L3 (available separately) (📷102) to release the shutter. It is convenient for taking group shots including yourself and effectively eliminates blur caused by camera shake that occurs when the shutter-release button is pressed.

Use of a tripod is recommended during shooting with the remote control. Set **Vibration reduction** (📷73) in the setup menu to **Off** when using a tripod to stabilize the camera.

- 1 Press **◀** (🕒 self-timer) on the rotary multi selector.

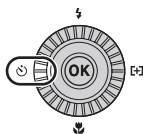

- 2 Select remote control mode using the multi selector and press **▶** to display the setting.

- Select the remote control setting and press the **OK** button.
- **📷**: Press the transmission button on the remote control to shoot instantly (quick-response remote).
- **🕒 10s** (10 seconds), **🕒 2s** (2 seconds) and **🕒 1s** (1 second) : Press the transmission button on the remote control to shoot with the selected seconds delay (self-timer remote control).
- The icon for the selected remote control mode is displayed.
- If the **OK** button is not pressed within a few seconds, the selection will be canceled.

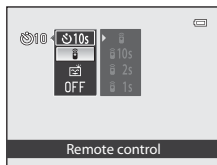

- 3 Frame the picture.

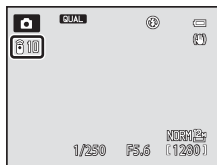

4 Aim the transmitter at the infrared receiver on the front of the camera (📖1) and press the transmission button.

- Press the transmission button from a distance of 5 m (16 ft) or less.
- In the quick-response remote mode, once the subject is in focus, the shutter is released.
- When the time for self-timer is set to **10s** (10 seconds) or **2s** (2 seconds), the self-timer lamp flashes when the subject is in focus, and then about one second before the shutter is released, the lamp stops flashing and remains lit. To stop the self-timer before a picture is taken, press the transmission button again.
- In the self-timer remote control mode, the remote control mode is set to **1** (quick-response remote) when the shutter is released.



Replacing the Battery for Remote Control ML-L3 (3V CR2025 Lithium Battery)

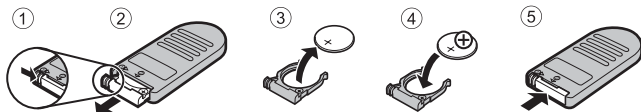

- When changing the remote control battery, be sure that the battery's positive (+) and negative (-) terminals are oriented correctly.
- Be sure to read and follow the warnings of "For Your Safety" (📖vi) and for "The Battery" (🔋10).

✓ Notes on the Remote Control

- The Remote Control may not function even from a distance of 5 m (16 ft) or less when shooting in backlit conditions.
- Some features cannot be used in combination with other menu settings. See "Features Not Available in Combination" (📖79) for more information.

📎 More Information

See "Self-timer: After Release" (🔋73) for more information.



A series of horizontal dashed lines for handwriting practice, spanning the width of the page.



Technical Notes and Index









Troubleshooting	2
Caring for the Products	9
The Camera.....	9
The Battery.....	10
The Battery Charger.....	11
The Memory Cards.....	12
Caring for the Camera	13
Cleaning.....	13
Storage	13
Specifications	14
Index	19







Troubleshooting

If the camera fails to function as expected, check the list of common problems below before consulting your retailer or Nikon-authorized service representative. Refer to the page numbers in the right-most column for more information.







- See “Error Messages” (🔍95) for more information.





Power, Display, Settings Issues

Problem	Cause/Solution	
The camera is on but does not respond.	<ul style="list-style-type: none"> • Wait for recording to end. • If the problem persists, turn the camera off. If the camera does not turn off, remove and reinsert the battery or batteries or, if you are using an AC adapter, disconnect and reconnect the AC adapter. <p>Note that although any data currently being recorded will be lost, data that have already been recorded will not be affected by removing or disconnecting the power source.</p>	– 23
Camera cannot be turned on.	<ul style="list-style-type: none"> • Battery is exhausted. • Camera cannot be turned on if the battery-chamber/memory card slot cover is open. • When the monitor is closed with the screen facing inward, the power cannot be turned on even if the power switch or  button is pressed. <p>When a computer or printer is connected to the camera, the camera automatically turns on even if the monitor is closed. If you turn off the camera and turn it on again while it is connected to the computer or printer, open the monitor and press the power switch.</p>	22 18 8
Camera turns off without warning.	<ul style="list-style-type: none"> • Battery is exhausted. • If no operations are performed for a while, camera has turned off automatically by auto off to save power. • Inside of the camera has become hot. Leave the camera off until the inside of the camera has cooled. • At low temperatures, the camera and the battery may not function normally. 	22 23 –  10
The monitor is blank.	<ul style="list-style-type: none"> • Camera is off. • Battery is exhausted. • Standby mode for saving power: Press the power switch, shutter-release button or  button, or rotate the mode dial. • Camera and computer are connected via USB cable. • Camera and TV are connected via audio/video cable or HDMI cable. • Interval timer shooting in progress. 	23 22 23 96, 99 96,  19  45
Monitor screen is hard to see.	<ul style="list-style-type: none"> • Adjust monitor screen brightness. • Monitor is dirty. Clean monitor screen. 	110,  71  13











Problem	Cause/Solution	
Date and time of recording are not correct.	<ul style="list-style-type: none"> If the camera clock has not been set ("Date not set" indicator flashes during shooting), still pictures have a time stamp of "00/00/0000 00:00"; and movies are dated "01/01/12 00:00." Set the correct date and time using Time zone and date in the setup menu. The camera clock is not as accurate as a normal clock, such as watches. Check camera clock regularly against more accurate timepieces and reset as required. 	24, 110,  69 110,  69
No information displayed in monitor.	Shooting and photo information may be hidden. Press the DISP button until shooting information or photo information is displayed.	9
Print date not available.	Time zone and date in the setup menu has not been set.	24, 110,  69
Date not appearing on pictures even when Print date is enabled.	<ul style="list-style-type: none"> A shooting mode that does not support print date is selected. Another function that is set now is restricting the print date. The date cannot be imprinted onto a movie. 	110,  72 79 –
Screen for setting time zone and date is displayed when camera is turned on. Camera settings reset.	Clock battery is exhausted; all settings were restored to their default values.	25
Reset file numbering cannot be done.	Reset file numbering cannot be applied when the folder number reaches 999 and there are images in the folder. Change the memory card, or format the internal memory/memory card.	113,  87
Monitor is turned off, and the power-on lamp flashes quickly.	Battery temperature is high. Turn off camera, and allow battery to cool down before resuming use. After the lamp flashes for 3 minutes, the camera turns off automatically, but you can also press the power switch to turn it off manually.	23
Camera temperature rises.	When functions such as movie recording or sending images using an Eye-Fi card are used for a long time, or when the camera is used in a location with a high ambient temperature, the camera temperature may rise. This is not a malfunction.	103

Shooting Issues





Problem	Cause/Solution	
Cannot set to shooting mode.	Disconnect the HDMI cable or USB cable.	96, 99,  19,  21
No picture can be taken.	<ul style="list-style-type: none"> When the camera is in playback mode, press the  button or shutter-release button. When menus are displayed, press the MENU button. Battery is exhausted. When the scene mode is Night portrait or Backlighting with HDR set to Off, raise the flash. If the flash mode icon flashes when the shutter-release button is pressed halfway, the flash is charging. When using the Speedlight, refer to the Speedlight instruction manual to check the settings. <ul style="list-style-type: none"> When shooting using Advanced Wireless Lighting photography, set the group setting to Group A. When using the built-in flash as the commander, set the channel of the flash unit to 3 CH. When the flash setting is enabled for a group other than Group A, disable the flash setting. 	32 10 22 37, 40, 56 56 87
Cannot take 3D images	In some shooting conditions, such as when the subject moves or the subject is dark or low in contrast, the second shot may not be taken or the 3D image may not be saved.	–
Camera cannot focus.	<ul style="list-style-type: none"> Incorrect focus mode setting. Check or change the setting. The intended subject is one with which autofocus does not perform well. Set AF assist in the setup menu to Auto. Subject is not in focus area when shutter-release button is pressed halfway. The focus mode is set to MF (manual focus). Turn camera off and then on again. 	62, 63 86 111,  74 30, 71 62 23
Colored stripes appear on the monitor when shooting.	Colored stripes may appear when shooting subjects with repeating patterns (such as window blinds); this is not a malfunction. The colored stripes will not appear in captured images or recorded movies. However, when using Continuous H: 120 fps or HS 120 fps (640×480) , the colored stripes may be seen in the captured images and recorded movies.	–
Pictures are blurred.	<ul style="list-style-type: none"> Use flash. Use vibration reduction. Use BSS (Best Shot Selector). Use a tripod to stabilize the camera (use with the self-timer for better results). 	56 111 71 59
Bright specks appear in pictures shot using flash.	Flash is reflecting off particles in air. Set the flash to  (off).	57

Problem	Cause/Solution	
Flash does not fire.	<ul style="list-style-type: none"> • Flash is set to  (off). • A shooting mode where flash cannot fire is selected. • Another function that is set now is restricting the flash. • The built-in flash does not fire when an external flash unit (optional) is used. • When shooting using Advanced Wireless Lighting photography, set the group setting to Group A. When using the built-in flash as the commander, set the channel of the remote flash unit to 3 CH. See the instruction manual of your Speedlight (external flash unit). 	57 64 79 87 87
The digital zoom is not available.	<ul style="list-style-type: none"> • Off or Crop is selected for Digital zoom in the setup menu. • When Scene auto selector, Portrait, Night portrait, Easy panorama in Panorama, Pet portrait or 3D photography is selected in scene mode, the digital zoom cannot be used. • The digital zoom cannot be used when Zoom exposure is selected in special effects mode. • Other functions that restrict the use of digital zoom are set. 	111 36, 36, 37, 41, 42, 43 46 79
Image size not available.	<ul style="list-style-type: none"> • Another function that is set now is restricting Image size. • When the scene mode is set to Easy panorama in Panorama or 3D photography, the image size is fixed. 	79 41, 43
No sound when shutter is released.	<ul style="list-style-type: none"> • Off is selected for Shutter sound under Sound settings in the setup menu. • Sports, Museum or Pet portrait is selected in scene mode. • Other functions that restrict the use of the shutter sound are set. • Do not block the speaker. 	111 37, 39, 42 79 2
AF-assist illuminator does not light.	Off is selected for AF assist in the setup menu. Even when Auto is set, AF-assist illuminator may not light depending on the focus area position or scene mode.	111
Pictures appear smeared.	Lens is dirty. Clean lens.	 13
Colors are unnatural.	White balance does not match light source.	68,  33
Ring-shaped or rainbow-colored bands are seen on the screen or the shot image.	When the subject is backlit or when shooting with an extremely bright light source in the display, such as in sunlight, ring-shaped or rainbow-colored bands may appear on the image. Change the position of the light source or remove it from the display, and try shooting again.	-
The image taken becomes grainy.	As the subject is dark, shutter speed is too slow or ISO sensitivity is too high. <ul style="list-style-type: none"> • Use flash. • Specify a lower ISO sensitivity setting. 	56 68,  31



Troubleshooting

Problem	Cause/Solution	
Pictures are too dark (underexposed).	<ul style="list-style-type: none"> Flash is set to  (off). Flash window is blocked. Subject is beyond flash range. Adjust exposure compensation. Raise the ISO sensitivity. Subject is backlit. Raise the flash, and set the scene mode Backlighting with HDR set to Off or set the flash mode to  (fill flash). On is selected for Built-in ND filter in the shooting menu. 	57 28 56 66 68,  31 40, 56 72
Pictures are too bright (overexposed).	<ul style="list-style-type: none"> Adjust exposure compensation. Use the Built-in ND filter setting in the shooting menu. 	66 72,  52
Areas not affected by red-eye are also corrected.	When  (auto with red-eye reduction) or “fill flash with red-eye reduction” of the Night portrait scene mode is applied during shooting, In-Camera Red-Eye Fix may, in very rare cases, be applied to areas not affected by red-eye. Set the flash mode to other than  (auto with red-eye reduction), select a scene mode other than Night portrait , and resume shooting.	37, 56
Skin softening results are not as expected.	<ul style="list-style-type: none"> Skin softening may not produce the desired results depending on shooting conditions. For pictures with 4 or more faces, try using Skin softening in the playback menu. 	44 93,  13
Saving images takes time.	It may take more time to save images in the following situations. <ul style="list-style-type: none"> When the noise reduction function is in operation When flash is set to  (auto with red-eye reduction) When taking pictures in the following scene modes. <ul style="list-style-type: none"> Hand-held in Night landscape HDR set to other than Off in Backlighting Easy panorama in Panorama Continuous in the shooting menu is set to Continuous H: 120 fps or Continuous H: 60 fps When using smile timer while shooting When using Active D-Lighting while shooting When Image quality is set to NRW (RAW), NRW (RAW) + Fine or NRW (RAW) + Normal 	– 57 38 40 41 71,  44 60 72,  53 75
Cannot set or use Continuous or Auto bracketing .	Another function that is set now is restricting the Continuous or Auto bracketing .	79
Cannot set COOLPIX Picture Control.	Another function that is set now is restricting COOLPIX Picture Control.	79

Playback Issues

Problem	Cause/Solution	
File cannot be played back.	<ul style="list-style-type: none"> File was overwritten or renamed by computer or another make or model of camera. File cannot be played back during interval timer shooting. NRW (RAW) images or movies recorded with cameras other than COOLPIX P7700 cannot be played back. 	– 71 75, 101
Cannot play a sequence.	<ul style="list-style-type: none"> Pictures shot continuously with cameras other than COOLPIX P7700 cannot be played as a sequence. Check the Sequence display options setting. 	– 94,  67
Cannot zoom in on picture.	<ul style="list-style-type: none"> Playback zoom cannot be used with movies, small pictures, or cropped copies of size 320 × 240 pixels or smaller. Playback zoom may not be available for pictures taken with cameras other than COOLPIX P7700. 3D images cannot be enlarged when the camera is connected via HDMI and they are played back in 3D. 	– – 43
Cannot record or play back voice memo.	<ul style="list-style-type: none"> Voice memos cannot be attached to movies. Voice memos cannot be attached to pictures taken with cameras other than COOLPIX P7700, and voice memos recorded by other cameras cannot be played back. 	109 94
Pictures and movies cannot be edited.	<ul style="list-style-type: none"> Confirm the conditions that are required for editing pictures or movies. Pictures and movies taken with cameras other than COOLPIX P7700 cannot be edited. 	94,  11,  26 –
Pictures are not displayed on television.	<ul style="list-style-type: none"> Video mode or HDMI is not correctly set in the TV settings setup menu. Cables are connected to both the HDMI mini connector and USB/audio video connector. Memory card contains no pictures. Replace memory card. Remove memory card to play back pictures from internal memory. 	112,  80 96 20
Nikon Transfer 2 does not start when camera is connected to a computer.	<ul style="list-style-type: none"> Camera is off. Battery is exhausted. USB cable is not correctly connected. Camera is not recognized by the computer. Confirm that the operating system used is compatible with the camera. Computer is not set to launch Nikon Transfer 2 automatically. For more information on Nikon Transfer 2, refer to help information contained in ViewNX 2. 	23 22 96 – 97 100
Pictures to be printed are not displayed.	<ul style="list-style-type: none"> Memory card contains no pictures. Replace memory card. Remove memory card to print pictures from internal memory. Pictures taken by 3D photography cannot be printed. 	20 21 43

Troubleshooting

Problem	Cause/Solution	
Cannot select paper size with camera.	Paper size cannot be selected from the camera in the following situations, even for PictBridge compatible printers. Use the printer to select paper size. <ul style="list-style-type: none"><li data-bbox="275 207 812 253">• The paper size selected using the camera is not compatible with the printer.<li data-bbox="275 253 812 274">• A printer that automatically sets the paper size is being used.	 22,  23 –

Caring for the Products

The Camera

To ensure continued enjoyment of this Nikon product, observe the following precautions when using or storing the device.

Be sure to read and follow the warnings of “For Your Safety” (📖vi to 📖viii) thoroughly before using the products.

✔ **Keep Dry**

The device will be damaged if immersed in water or subjected to high humidity.

✔ **Do Not Drop**

The product may malfunction if subjected to strong shock or vibration.

✔ **Handle the Lens and All Moving Parts with Care**

Do not apply force to the lens, lens cover, monitor, memory card slot, or battery chamber. These parts are easily damaged. Applying force to the lens cover could result in camera malfunction or damage to the lens. Should the monitor break, care should be taken to avoid injury caused by broken glass and to prevent the liquid crystal from the display touching the skin or entering the eyes or mouth.

✔ **Do Not Point the Lens at Strong Light Sources for Extended Periods**

Avoid pointing the lens at the sun or other strong light sources for extended periods when using or storing the camera. Intense light may cause deterioration of the image sensor, producing a white blur effect in photographs.

✔ **Keep away from Strong Magnetic Fields**

Do not use or store this device in the vicinity of equipment that generates strong electromagnetic radiation or magnetic fields. Strong static charge or the magnetic fields produced by equipment such as radio transmitters could interfere with the monitor, damage data saved on the memory card, or affect the product's internal circuitry.

✔ **Avoid Sudden Changes in Temperature**

Sudden changes in temperature, such as when entering or leaving a heated building on a cold day, can cause condensation to form inside the device. To prevent condensation, place the device in a carrying case or a plastic bag before exposing it to sudden changes in temperature.



✔ **Turn the Product off Before Removing or Disconnecting the Power Source or the Memory Card**

Do not remove the battery while the product is on, or while images are being saved or deleted. Forcibly cutting power in these circumstances could result in loss of data or in damage to product memory or internal circuitry.

Notes on the Monitor

- Monitors and electronic viewfinders are constructed with extremely high precision; at least 99.99% of pixels are effective, with no more than 0.01% being missing or defective. Hence while these displays may contain pixels that are always lit (white, red, blue, or green) or always off (black), this is not a malfunction and has no effect on images recorded with the device.
- Images on the monitor may be difficult to see under bright lighting.
- The monitor is lit by an LED backlight. Should the monitor begin to dim or flicker, contact your Nikon-authorized service representative.

The Battery

- Be sure to read and follow the warnings of “For Your Safety” (vi to viii) thoroughly before using the battery.
- Check the battery level before using the camera and replace or charge the battery if necessary. Do not continue charging once the battery is fully charged as this will result in reduced battery performance. Whenever possible, carry a fully charged spare battery when taking pictures on important occasions.
- Do not use the battery at ambient temperatures below 0°C (32°F) or above 40°C (104°F).
- Charge the battery indoors with an ambient temperature of 5°C to 35°C (41°F to 95°F) before use.
- When the battery temperature is between 0°C and 10°C (32°F to 50°F) or 45°C to 60°C (113°F to 140°F), the chargeable capacity may decrease.
- The battery is not charged at ambient temperatures below 0°C (32°F) or above 60°C (140°F).
- Note that the battery may become hot during use; wait for the battery to cool before charging. Failure to observe these precautions could damage the battery, impair its performance, or prevent it from charging normally.
- On cold days, the capacity of batteries tends to decrease. Be sure that the battery is fully charged before heading outside to take pictures in cold weather. Keep spare batteries in a warm place and exchange as necessary. Once warmed, a cold battery may recover some of its charge.
- Dirt on the battery terminals can prevent the camera from functioning. Should the battery terminals become dirty, wipe them off with a clean, dry cloth before use.

- If the battery will not be used for some time, insert it in the camera and run it flat before removing it for storage. The battery should be stored in a cool location with an ambient temperature of 15°C to 25°C (59°F to 77°F). Do not store the battery in hot or extremely cold locations.
- Always remove the battery from the camera or battery charger when it is not being used. When inserted, minute amounts of current are drawn from the battery even when not in use. This may result in excessive draining of the battery and complete loss of function. Turning the camera on or off while the battery is exhausted can result in reduced battery life. When the battery level is low, be sure to charge the battery before using it.
- Recharge the battery at least once every six months and completely exhaust it before returning it to storage.
- After removing the battery from the camera or battery charger, attach the included terminal cover to the battery and store it in a cool place.
- A marked drop in the time a fully-charged battery retains its charge, when used at room temperature, indicates that the battery needs to be replaced. Purchase a new EN-EL14 battery.
- Replace the battery when it no longer holds a charge. Used batteries are a valuable resource. Please recycle used batteries in accordance with local regulations.

The Battery Charger

- Be sure to read and follow the warnings of "For Your Safety" (📖vi to 📖viii) thoroughly before using the battery charger.
- The included Battery Charger is for use only with a Rechargeable Li-ion Battery EN-EL14.
- The MH-24 is compatible with AC 100-240 V, 50/60 Hz electrical outlets. When using in other countries, use a commercially available plug adapter as necessary. For more information about plug adapters, consult your travel agency.

The Memory Cards

- Use only Secure Digital memory cards. See “Approved Memory Cards” (📖21).
- Be sure to observe the precautions in the memory card documentation when you use the memory card.
- Do not affix labels or stickers to the memory card.
- Do not format the memory card using a computer.
- When a memory card that has been used in another device is used for the first time, be sure to format it with this camera.
When a new memory card is used, it is recommended to format it with this camera first.
- Formatting permanently deletes all data in the memory card. Be sure to transfer important pictures to a computer before formatting.
- If the error message “Card is not formatted. Format card?” is displayed when you insert a memory card into this camera, the memory card must be formatted. If the memory card contains images you wish to keep, select **No** and save those images on your computer before formatting the memory card. To format the card, select **Yes** and press the **OK** button.
- Do not perform the following during formatting, while data is being written to or deleted from the memory card, or during data transfer to a computer. Failure to observe this precaution could result in loss of data or damage to the memory card:
 - Open the battery-chamber/memory card slot cover to remove the battery or memory card.
 - Turn off the camera
 - Disconnect the AC adapter

Caring for the Camera

Cleaning

Lens	Avoid touching glass parts with your fingers. Remove dust or lint with a blower (typically a small device with a rubber bulb attached to one end that is pumped to produce a stream of air out the other end). To remove fingerprints, oily substances, or other stains that cannot be removed with a blower, carefully wipe the lens with a dry soft cloth or eyewear cleaning cloth, using a spiral motion that starts at the center of the lens and working toward the edges. Do not wipe the lens forcibly or with a hard material. Failure to observe this precaution could result in damage or trouble. If this fails, clean the lens using a cloth lightly dampened with commercial lens cleaner.
Monitor	Remove dust or lint with a blower. To remove fingerprints, oily substances or other stains, carefully wipe the monitor with a dry soft cloth or eyewear cleaning cloth. Do not wipe the monitor forcibly or with a hard material. Failure to observe this precaution could result in damage or trouble.
Body	Use a blower to remove dust, dirt, or sand, then wipe gently with a soft, dry cloth. After using the camera at the beach or other sandy or dusty environment, wipe off any sand, dust, or salt with a dry cloth lightly dampened with fresh water and dry thoroughly. Note that foreign matter inside the camera could cause damage not covered by the warranty.

Do not use volatile organic solvents such as alcohol or thinner, chemical detergents, anticorrosive agents, or anti-fogging agents.

Storage

Remove the battery if the camera will not be used for an extended period. Do not store the camera with naphtha or camphor moth balls, or in any of the following locations:

- Next to equipment that produces strong electromagnetic fields, such as televisions or radios
- Exposed to temperatures below -10°C (14°F) or above 50°C (122°F)
- Places that are poorly ventilated or subject to humidity of over 60%

To prevent mold or mildew, take the camera out of storage at least once a month. Turn the camera on and release the shutter a few times before putting the camera away again.

Be sure to read and follow the warnings given in “The Battery” (🔋10) of “Caring for the Products” to store the battery.

Specifications

Nikon COOLPIX P7700 Digital Camera

Type	Compact digital camera
Number of effective pixels	12.2 million
Image sensor	1/1.7-in. type CMOS; approx. 12.76 million total pixels
Lens	7.1× optical zoom, NIKKOR lens
Focal length	6.0-42.8 mm (angle of view equivalent to that of 28-200 mm lens in 35mm [135] format)
f/-number	f/2-4
Construction	13 elements in 10 groups (2 ED lens elements)
Digital zoom magnification	Still pictures: Up to 4× (angle of view equivalent to that of approx. 800 mm lens in 35mm [135] format) Movies: Up to 2× (angle of view equivalent to that of approx. 400 mm lens in 35mm [135] format)
Vibration reduction	Lens shift
Autofocus (AF)	Contrast-detect AF
Focus range	<ul style="list-style-type: none">• [W]: Approx. 50 cm (1 ft 8 in.) - ∞• [T]: Approx. 80 cm (2 ft 8 in.) - ∞• Macro close-up mode: Approx. 2 cm (0.8 in.) (at a wide-angle zoom position) - ∞ (All distances measured from center of front surface of lens)
Focus-area selection	Face priority, auto (9-area automatic selection), center (wide, normal), manual with 99 focus areas, subject tracking, target finding AF
Monitor	7.5 cm (3-in.), approx. 921k-dot, wide viewing angle TFT LCD with anti-reflection coating and 5-level brightness adjustment, Vari-angle TFT LCD
Frame coverage (shooting mode)	Approx. 100% horizontal and 100% vertical (compared to actual picture)
Frame coverage (playback mode)	Approx. 100% horizontal and 100% vertical (compared to actual picture)
Storage	
Media	Internal memory (approx. 86 MB) SD/SDHC/SDXC memory card
File system	DCF, Exif 2.3, DPOF, and MPF compliant
File formats	Still pictures: JPEG, NRW (RAW) (Nikon's own format) 3D images: MPO Sound files (voice memo): WAV Movies: MOV (Video: H.264/MPEG-4 AVC, Audio: AAC stereo)

Image size (pixels)	<ul style="list-style-type: none"> • 12 M 4000×3000 • 4 M 2272×1704 • VGA 640×480 • 16:9 9M 3968×2232 • 8 M 3264×2448 • 2 M 1600×1200 • 3:2 3984×2656 • 1:1 3000×3000
ISO sensitivity (Standard output sensitivity)	<ul style="list-style-type: none"> • ISO 80 - 1600 • ISO 3200, Hi 1 (equivalent to 6400) (available when using P, S, A or M mode)
Exposure	<p>Matrix (224-segment matrix), center-weighted, or spot. Also when AF area mode is set to Manual, the AF area can be coupled to the metering range using Focus-coupled metering.</p> <p>Programmed auto exposure with flexible program, shutter priority auto, aperture-priority auto, manual, exposure bracketing (Tv, Av, Sv) enabled, exposure compensation (in steps of 1/3 EV in the range of +/-3.0 EV for still pictures and +/-2.0 EV for movies) enabled</p>
Metering mode	
Exposure control	
Shutter	Mechanical and CMOS electronic shutter
Speed	<ul style="list-style-type: none"> • 1/4000 * - 1 s • 1/4000 * - 60 s (when ISO sensitivity is set to 80 - 400 in M mode) <p>* When the aperture value is set to f/4.5 - f/8 (wide-angle position) or the value is set to f/7.1 - f/8 (telephoto zoom position)</p>
Aperture	Electronically-controlled 7-blade iris diaphragm
Range	13 steps of 1/3 EV (W) (A , M mode)
Self-timer	Durations of 1, 2 or 10 seconds can be selected
Built-in flash	<p>[W]: 0.5 - 10 m (1 ft 8 in. - 32 ft) [T]: 0.5 - 5.5 m (1 ft 8 in. - 18 ft)</p> <p>TTL auto flash with monitor pre-flashes and manual flash enabled</p>
Range (approx.) (ISO sensitivity: Auto)	
Flash control	
Flash exposure compensation	In steps of 1/3 EV in the range between -2 and +2 EV
Accessory shoe	ISO 518 hot-shoe with sync and data contacts and safety lock
Nikon Creative Lighting System	<ul style="list-style-type: none"> • i-TTL flash control support in combination with Nikon Creative Lighting System-compatible Speedlights (only Standard i-TTL flash control is supported during spot metering mode). • Flash Color Information Communication is supported. • Advanced Wireless Lighting is supported by setting SB-910, SB-900, SB-800 or SB-700 to master flash or by setting SU-800 to the Commander mode (the remote flash setting is only applicable to Group A). • Advanced Wireless Lighting is supported by setting the built-in flash to the Commander mode (only applicable to Group A and fixed at 3 CH).

Specifications

Interface	Hi-Speed USB
Data transfer protocol	MTP, PTP
Video output	Can be selected from NTSC and PAL
HDMI output	Can be selected from Auto, 480p, 720p, and 1080i
I/O terminal	<ul style="list-style-type: none">• Audio/video output; digital I/O (USB)• HDMI Mini Connector (Type C) (HDMI output)• External microphone connector (stereo mini-pin jack (3.5 mm diameter), plug-in power type)• Accessory terminal
Supported languages	Arabic, Bengali, Chinese (Simplified and Traditional), Czech, Danish, Dutch, English, Finnish, French, German, Greek, Hindi, Hungarian, Indonesian, Italian, Japanese, Korean, Norwegian, Polish, Portuguese (European and Brazilian), Romanian, Russian, Spanish, Swedish, Tamil, Thai, Turkish, Ukrainian, Vietnamese
Power sources	<ul style="list-style-type: none">• One Rechargeable Li-ion Battery EN-EL14 (included)• AC Adapter EH-5b (used in combination with the Power Connector EP-5A) (available separately)
Battery life¹	
Still pictures	Approx. 330 shots when using EN-EL14
Movie recording (actual battery life for recording)²	Approx. 1 h 10 min when using EN-EL14
Tripod socket	1/4 (ISO 1222)
Dimensions (W × H × D)	Approx. 118.5 × 72.5 × 50.4 mm (4.7 × 2.9 × 2.0 in.) (excluding projections)
Weight	Approx. 392 g (13.9 oz) (including battery and SD memory card)
Operating environment	
Temperature	0°C - 40°C (32°F - 104°F)
Humidity	85% or less (no condensation)

- Unless otherwise stated, all figures assume a fully-charged battery and an ambient temperature of 23 ±3 °C (73.4 ±5.4 °F) as specified by the Camera and Imaging Products Association (CIPA).

¹ Figures based on the Camera and Imaging Products Association (CIPA) standards for measuring the endurance of camera batteries. Performance for still pictures measured under the following test conditions: **Normal** selected for Image quality,  **4000×3000** selected for Image size, zoom adjusted with each shot, and flash fired with every other shot. Movie recording time assumes that  **HD 1080p★ (1920×1080)** is selected for Movie options. The values may vary depending on operating conditions such as the interval between shots and the length of time menus and images are displayed.

² Individual movie files cannot exceed 4 GB in size or 29 minutes in length. Recording may end before this limit is reached if camera temperature becomes elevated.

Rechargeable Li-ion Battery EN-EL14

Type	Rechargeable lithium-ion battery
Rated capacity	DC 7.4 V, 1030 mAh
Operating temperature	0°C - 40°C (32°F - 104°F)
Dimensions (W × H × D)	Approx. 38 × 53 × 14 mm (1.5 × 2.1 × 0.6 in.) (excluding projections)
Weight	Approx. 48 g (1.7 oz) (excluding terminal cover)

Battery Charger MH-24

Rated input	AC 100 - 240 V, 50/60 Hz, 0.2 A max.
Rated output	DC 8.4 V, 0.9 A
Supported rechargeable battery	Rechargeable Li-ion Battery EN-EL14
Charging time	Approx. 1 hour and 30 minutes when no charge remains
Operating temperature	0°C - 40°C (32°F - 104°F)
Dimensions (W × H × D)	Approx. 70 × 26 × 97 mm (2.8 × 1.0 × 3.8 in.) (excluding plug adapter) For Argentina: Approx. 70 × 68 × 104 mm (2.8 × 2.7 × 4.1 in.) For Korea: Approx. 70 × 76.5 × 104 mm (2.8 × 3.0 × 1.1 in.)
Weight	Approx. 89 g (3.1 oz) (excluding plug adapter) For Argentina: Approx. 125 g (4.5 oz) For Korea: Approx. 120 g (4.2 oz)

Specifications

- Nikon will not be held liable for any errors this manual may contain.
- The appearance of this product and its specifications are subject to change without notice.

Supported Standards

- **DCF:** Design Rule for Camera File System is a standard widely used in the digital camera industry to ensure compatibility among different makes of camera.
- **DPOF:** Digital Print Order Format is an industry-wide standard that allows pictures to be printed at a digital photo lab or with a household printer from print orders stored on the memory card.
- **Exif version 2.3:** This camera supports Exif (Exchangeable Image File Format for Digital Still Cameras) version 2.3, a standard that allows information stored with photographs to be used for optimal color reproduction when images are output from Exif-compliant printers.
See the instruction manual of the printer for further details.
- **PictBridge:** A standard developed cooperatively by the digital camera and printer industries, allowing photographs to be output directly to a printer without connecting the camera to a computer.

AVC Patent Portfolio License

This product is licensed under the AVC Patent Portfolio License for the personal and non-commercial use of a consumer to (i) encode video in compliance with the AVC standard ("AVC video") and/or (ii) decode AVC video that was encoded by a consumer engaged in a personal and non-commercial activity and/or was obtained from a video provider licensed to provide AVC video. No license is granted or shall be implied for any other use. Additional information may be obtained from MPEG LA, L.L.C.

See <http://www.mpegla.com>.

FreeType License (FreeType2)

Portions of this software are copyright (c) 2012 The FreeType Project ("www.freetype.org"). All rights reserved.

MIT License (Harfbuzz)





























Portions of this software are copyright (c) 2012 The Harfbuzz Project ("http://www.freedesktop.org/wiki/Software/HarfBuzz"). All rights reserved.





Trademark Information

- Microsoft, Windows and Windows Vista are either registered trademarks or trademarks of Microsoft Corporation in the United States and/or other countries.
- Macintosh, Mac OS, and QuickTime are trademarks of Apple Inc., registered in the U.S. and other countries.
- Adobe and Acrobat are registered trademarks of Adobe Systems Inc.
- SDXC, SDHC and SD Logos are trademarks of SD-3C, LLC.
- PictBridge is a trademark.
- HDMI, **HDMI** logo and High-Definition Multimedia Interface are trademarks or registered trademarks of HDMI Licensing LLC.
- All other trade names mentioned in this manual or the other documentation provided with your Nikon product are trademarks or registered trademarks of their respective holders.



















Index





Symbols

AE/AF-L 43, 
AE-L/AF-L button 4
[H] AF area mode 55, 71, 
A Aperture-priority auto mode 48, 50
[OK] Apply selection button 6
BKT Auto bracketing 67, 68, 
 Auto mode 26, 34
 Delete button 33, , 
DISP Display button 9
 Flash mode 55, 56
 Flash pop-up control 56
 Focus mode 55, 62
Fn1 Function 1 button 4, ,
, , 
Fn2 Function 2 button 4, 
QUAL Image quality/Image size/Movie
options 67, 68, 75, 105, 
ISO ISO sensitivity 67, 68, 105, 106,

M Manual mode 48, 50
MENU Menu button 10, 70, 93, 107,
110
 CSM Movie custom setting mode 101
 Movie mode 101
 My Menu 67, 68, 
 Picture Control 67, 68, 105, 106,

 Playback button 5, 32
 Playback zoom 91
P Programmed auto mode 48, 50
SCENE Scene mode 35
 Self-timer/Smile timer/Remote control
55, 59, 60, 
S Shutter-priority auto mode 48, 50
EFFECTS Special effects mode 45
T Tele 29
 Thumbnail display 92
U1, U2 or U3 User settings mode 52
WB White balance 67, 68, 105, 106,

W Wide 29
JPG 
.MOV 
.MPO 
.NRW 
.WAV 

Numerics

3D photography  43
A
AC adapter 17, , 
Accessory shoe 1, 87
Accessory Shoe Cover 1, 87
Accessory terminal 2, 
Active D-Lighting 72, 
AE/AF lock button 113, 
AF area mode 55, 71, 
AF assist 111, 
AF mode 71, 108, , 
AF/access lamp 30
Aperture value 48
Aperture-priority auto mode 48, 50
Audio/video cable 96, 
Audio/video-in jack 96, 99, 
Auto 57
Auto bracketing 67, 68, , 
Auto off 23, 111, 
Auto with red-eye reduction 57, 58
Autofocus mode 63, 71, 108, ,

AV cable 96, 

B
Backlighting  40
Battery 16, 18
Battery charger 16
Battery level indicator 22
Battery-chamber/memory card slot cover
18, 20
Beach  37
Best shot selector 39, 71, 
Black and white copy  39

Black border 94, 15
 BSS 71, 44
 Built-in ND filter 72, 108, 52
 Button sound 111, 77

C

Calendar display 92
 Charger 16
 Choose key picture 94, 67
 Close range only 63
 Close-up 38
 CLS 87
 Color temperature 34
 Command dial 3, 5, 48
 Command dial rotation 112, 81
 Commander mode 57, 72, 56
 Computer 96, 99
 Continuous 71, 44
 Contrast 40
 COOLPIX Custom Picture Control 71, 107, 42
 COOLPIX Picture Control 67, 68, 105, 106, 38
 Crop 18
 Custom Picture Control 71, 107, 42
 Customize command dials 112, 81
 Customize My Menu 113, 86

D

Date and time 24, 69
 Daylight saving time 24, 70
 Delete 33, 109, 9, 63, 65
 Delete button options 112, 82
 Digital zoom 29, 111, 75
 Direct Print 96, 21
 Distortion control 72, 53
 D-Lighting 93, 12
 DPOF printing 24
 DSCN 100
 Dusk/dawn 38





E

Easy panorama 41, 3
 Editing movies 26
 Editing Pictures 10



Exposure compensation 66
 Exposure compensation dial 66
 Exposure mode 48
 Extension 100
 External flash unit 87, 56, 102
 External mic sensitivity 112, 80
 External microphone 104, 102
 Extracting still pictures 109, 27
 Eye-Fi upload 114, 89
 Eyelet for camera strap 7

F









Face detection 85
 Face priority 71, 47
 Fast motion movies 104, 30
 Features not available in combination 79
 File name 100
 Fill flash 57
 Filter effects 93, 14, 40
 Fireworks show 39
 Firmware version 114, 94
 Fixed aperture 111, 76
 Flash 55, 56
 Flash control 114, 90
 Flash exp. comp. 71, 51
 Flash mode 55, 56
 Fn1 + command dial 4, 113, 84
 Fn1 + selector dial 4, 113, 84
 Fn1 + shutter button 4, 113, 83
 Fn1 guide display 4, 113, 85
 Fn2 button 113, 85
 Focal length 72, 54, 14
 Focus 30, 47, 51, 59
 Focus area 31, 47
 Focus lock 86
 Focus mode 55, 62
 Focus-coupled metering 72, 55
 Folder name 100
 Food 39
 Format 20, 112, 79
 Format the internal memory 112, 79
 Format the memory card 20, 112, 79

Framing grid 12, 110, 71
 FSCN 100
 Full-frame playback 32
 Full-time AF 71, 108, 51, 59







G

GPS options 114, 87
 GPS Unit 88, 102







H

HDMI 112, 19, 80
 HDMI 3D output 80
 HDMI device control 112, 80
 HDMI mini connector 96, 19
 HDR 40
 High-speed continuous 71, 44
 Histogram 15, 110, 71
 HS movie 104, 29, 30

I















Identifier 100
 Image copy 94, 66
 Image quality 75
 Image sharpening 40
 Image size 75, 77
 Infinity 63
 Internal memory indicator 22
 Interval Timer Shooting 71, 44, 45
 ISO sensitivity 67, 68, 105, 106, 31
 ISO sensitivity step value 111, 74

L







Landscape  37
 Language 112, 79
 Lens 13, 14
 Lens cap 7
 Lens hood 103
 Lens ring 1, 103
 Li-ion rechargeable battery 16

M

M exposure preview 72, 55
 Macro close-up 63
 Main command dial 3, 5, 48
 Manual 57

Manual focus 63, 2
 Manual mode 48, 50
 Memory capacity 22
 Memory card 20, 21
 Memory card slot 20
 Metering 71, 43
 MF distance indicator units 114, 90
 Microphone 101, 65
 Minimum shutter speed 68, 106, 31
 Mode dial 26
 Monitor 8, 9, 12, 13
 Monitor brightness 110, 71
 Monitor settings 110, 71
 Movie custom setting mode 101
 Movie length 101, 29
 Movie menu 107
 Movie mode 101
 Movie options 106, 28
 Movie playback 109
 Movie recording 101
 Multi selector 3, 5, 55
 Multi selector right press 112, 81
 Multi-shot 16 71, 44
 Museum  39
 My Menu 68, 113, 86



N

Night landscape  38
 Night portrait  37
 Nikon Creative Lighting System 87, 15
 Noise reduction filter 71, 52
 NRW (RAW) Images 76, 16
 NRW (RAW) processing 94, 16
 Number of exposures remaining 22, 78



















O



Off 57
 Optical zoom 29
 Optional accessories 102









P



Panorama assist 41, 6
 Panorama  41
 Paper size 25

Index

























Party/indoor  37
Pet portrait  42
Photo info 110, 
PictBridge 96, , 
Picture Control 67, 68, 105, 106, 
Playback 32, 109, 
Playback menu 93
Playback mode 32
Playback zoom 91
Portrait  36
Power 22, 23, 24
Power connector 17, , 
Power switch/power-on lamp 2, 23
Preset manual 
Pressing halfway 4, 30
Print , , 
Print date 110, 
Print order 93, 
Print order date option 
Printer 96, 
Programmed auto mode 48, 50
Protect 93, 

Q
Quick adjust 
Quick menu 67, 105
Quick menu dial 67, 105
Quick retouch 93, 







R
Rear-curtain sync 57
Rechargeable battery 16
Record orientation 111, 
Recording slow motion movies 104, 
Remote control 55, , 
Remote cord 
Reset all 114, 
Reset file numbering 113, 
Reset user settings 54
Reverse indicators 114, 
Rotary multi selector 3, 5, 55
Rotate image 93, 

Rotate tall 111, 
RSCN 



S

Saturation 
Save user setting 
Scene auto selector  36
Scene mode 35
Selecting pictures 95
Self-timer 55, 59
Self-timer lamp 59
Self-timer: after release 110, 
Sequence 32, 
Sequence display options 94, 
Setup menu 110
Shooting 26
Shooting date information 9, 12
Shooting menu 70
Shooting mode 27, 108, 
Shutter sound 111, 
Shutter speed 48, 82
Shutter-priority auto mode 48, 50
Shutter-release button 4, 6, 30
Single 71, 
Single AF 71, 108, , 
Skin softening 44, 93, 
Slide show 93, 
Slow sync 57
Small picture 93, 
Smile timer 55, 60
Snow  37
Sound settings 111, 
Special effects mode 45
Speedlight 87, 
Sports  37
SSCN 
Startup zoom position 72, 
Straighten 94, 
Sub-command dial 3, 5, 48
Subject tracking 71, , 
Sunset  37
Switching between tabs 11







I

- Target finding AF 71, 84, 49
- Tele 29
- Thumbnail playback 92
- Time difference 70
- Time zone 24, 70
- Time zone and date 24, 110, 69
- Tone level 15
- Tone level information 9, 14, 71
- Toning 41
- TV settings 112, 80



U

- USB cable 96, 99, 21
- USB/Audio/video output connector 96, 99, 19, 21
- User setting modes 52



V

- Vibration reduction 111, 73
- Video mode 112, 80
- View grid 39
- ViewNX 2 97
- Virtual horizon 12, 110, 71
- Virtual horizon display 110, 71
- Voice memo 94, 65
- Volume 109

W

- Welcome screen 110, 68
- White balance 67, 68, 105, 106, 33
- Wide 29
- Wind noise reduction 108, 59

Z

- Zoom 29
- Zoom control 3, 5, 29
- Zoom memory 72, 54
- Zoom speed 111, 76



A series of horizontal dashed lines spanning the width of the page, intended for handwriting practice.



A series of horizontal dashed lines spanning the width of the page, intended for handwriting practice. There are 18 lines in total, starting from the top right and extending to the bottom left.

No reproduction in any form of this manual, in whole or in part (except for brief quotation in critical articles or reviews), may be made without written authorization from NIKON CORPORATION.