

Nikon

DIGITAL CAMERA

COOLPIX S3300

Reference Manual



En

Trademark Information

- Microsoft, Windows and Windows Vista are either registered trademarks or trademarks of Microsoft Corporation in the United States and/or other countries.
- Macintosh, Mac OS, and QuickTime are trademarks of Apple Inc., registered in the U.S. and other countries.
- Adobe and Acrobat are registered trademarks of Adobe Systems Inc.
- SDXC, SDHC, and SD Logos are trademarks of SD-3C, LLC.
- PictBridge is a trademark.
- All other trade names mentioned in this manual or the other documentation provided with your Nikon product are trademarks or registered trademarks of their respective holders.

Introduction

Parts of the Camera and Basic Operation

Basic Steps for Shooting and Playback

Shooting Features

Playback Features

Recording and Playing Back Movies

General Camera Setup

Reference Section

Technical Notes and Index

Read This First

Thank you for purchasing the Nikon COOLPIX S3300 digital camera. Before using the camera, please read the information in "For Your Safety" (16) and familiarize yourself with the information provided in this manual. After reading, please keep this manual handy and refer to it to enhance your enjoyment of your new camera.

Confirming the Package Contents

In the event that any items are missing, please contact the store where you purchased the camera.



COOLPIX S3300
Digital Camera



Camera Strap



Rechargeable Li-ion Battery
EN-EL19
(with battery case)

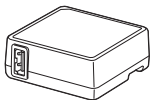

Charging AC Adapter
EH-69P*

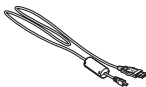

USB Cable UC-E6

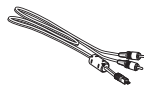

Audio Video Cable EG-CP14



ViewNX 2 Installer CD



Reference Manual CD

- Warranty

* A plug adapter is included only in countries or regions where required, and its shape varies with country or region of purchase (16).

NOTE: A memory card is not included with the camera.

About This Manual





If you want to start using the camera right away, see “Basic Steps for Shooting and Playback” (📖13).

To learn about the parts of the camera and basic operations, see “Parts of the Camera and Basic Operation” (📖1).

Other Information

• Symbols and Conventions

To make it easier to find the information you need, the following symbols and conventions are used in this manual:

Symbol	Description
	This icon marks cautions, information that should be read before use, to prevent damage to the camera.
	This icon marks notes, information that should be read before using the camera.
	These icons indicate other pages containing relevant information;  : “Reference Section”,  : “Technical Notes and Index.”

- SD, SDHC, and SDXC memory cards are referred to as “memory cards” in this manual.
- The setting at the time of purchase is referred to as the “default setting.”
- The names of menu items displayed in the camera monitor, and the names of buttons or messages displayed on a computer monitor appear in bold.
- In this manual, images are sometimes omitted from monitor display samples so that monitor indicators can be more clearly shown.
- Illustrations and text displays shown in this manual may differ from actual display.

Information and Precautions

Life-Long Learning

As part of Nikon's "Life-Long Learning" commitment to ongoing product support and education, continually updated information is available online at the following sites:

- For users in the U.S.A.: <http://www.nikonusa.com/>
- For users in Europe and Africa: <http://www.europe-nikon.com/support/>
- For users in Asia, Oceania, and the Middle East: <http://www.nikon-asia.com/>

Visit these sites to keep up-to-date with the latest product information, tips, answers to frequently asked questions (FAQs), and general advice on digital imaging and photography. Additional information may be available from the Nikon representative in your area. Visit the site below for contact information.

<http://imaging.nikon.com/>

Use Only Nikon Brand Electronic Accessories

Nikon COOLPIX cameras are designed to the highest standards and include complex electronic circuitry. Only Nikon brand electronic accessories (including battery chargers, batteries, Charging AC Adapter, and AC adapters) certified by Nikon specifically for use with this Nikon digital camera are engineered and proven to operate within the operational and safety requirements of this electronic circuitry.

THE USE OF NON-NIKON ELECTRONIC ACCESSORIES COULD DAMAGE THE CAMERA AND MAY VOID YOUR NIKON WARRANTY.

The use of third-party rechargeable Li-ion batteries not bearing the Nikon holographic seal could interfere with normal operation of the camera or result in the batteries overheating, igniting, rupturing, or leaking.

For more information about Nikon brand accessories, contact a local authorized Nikon dealer.



Holographic seal:

Identifies this device as an authentic Nikon product.

Before Taking Important Images

Before taking images on important occasions (such as at weddings or before taking the camera on a trip), take a test shot to ensure that the camera is functioning normally. Nikon will not be held liable for damages or lost profits that may result from product malfunction.

About the Manuals

- No part of the documentation included with this product may be reproduced, transmitted, transcribed, stored in a retrieval system, or translated into any language in any form, by any means, without Nikon's prior written permission.
- Nikon reserves the right to change the specifications of the hardware and software described in the documentation at any time and without prior notice.
- Nikon will not be held liable for any damages resulting from the use of this product.
- While every effort was made to ensure that the information in the documentation is accurate and complete, we would appreciate it were you to bring any errors or omissions to the attention of the Nikon representative in your area (address provided separately).

Notice Concerning Prohibition of Copying or Reproduction

Note that simply being in possession of material that was digitally copied or reproduced by means of a scanner, digital camera or other device may be punishable by law.

• Items prohibited by law from being copied or reproduced

Do not copy or reproduce paper money, coins, securities, government bonds or local government bonds, even if such copies or reproductions are stamped "Sample." The copying or reproduction of paper money, coins, or securities which are circulated in a foreign country is prohibited. Unless the prior permission of the government was obtained, the copying or reproduction of unused postage stamps or post cards issued by the government is prohibited. The copying or reproduction of stamps issued by the government and of certified documents stipulated by law is prohibited.

• Cautions on certain copies and reproductions

The government has issued cautions on copies or reproductions of securities issued by private companies (shares, bills, checks, gift certificates, etc.), commuter passes or coupon tickets, except when a minimum of necessary copies are to be provided for business use by a company. Also, do not copy or reproduce passports issued by the government, licenses issued by public agencies and private groups, ID cards and tickets, such as passes and meal coupons.

• Comply with copyright notices

The copying or reproduction of copyrighted creative works such as books, music, paintings, woodcut prints, maps, drawings, movies and photographs is governed by national and international copyright laws. Do not use this product for the purpose of making illegal copies or to infringe copyright laws.

Disposing of Data Storage Devices

Please note that deleting images or formatting data storage devices such as memory cards or built-in camera memory does not completely erase the original image data. Deleted files can sometimes be recovered from discarded storage devices using commercially available software, potentially resulting in the malicious use of personal image data. Ensuring the privacy of such data is the user's responsibility.

Before discarding a data storage device or transferring ownership to another person, erase all data using commercial deletion software, or format the device and then completely refill it with images containing no private information (for example, images of empty sky). Be sure to also replace any images selected for the **Select an image** option in the **Welcome screen** setting (□86). Care should be taken to avoid injury or damage to property when physically destroying data storage devices.

For Your Safety

To prevent damage to your Nikon product or injury to yourself or to others, read the following safety precautions in their entirety before using this equipment. Keep these safety instructions where all those who use the product will read them.

The consequences that could result from failure to observe the precautions listed in this section are indicated by the following symbol:



This icon marks warnings, information that should be read before using this Nikon product, to prevent possible injury.

WARNINGS

Turn off in the event of malfunction

Should you notice smoke or an unusual smell coming from the camera or Charging AC Adapter, unplug the Charging AC Adapter and remove the battery immediately, taking care to avoid burns. Continued operation could result in injury. After removing or disconnecting the power source, take the equipment to a Nikon-authorized service representative for inspection.

Do not disassemble

Touching the internal parts of the camera or Charging AC Adapter could result in injury. Repairs should be performed only by qualified technicians. Should the camera or Charging AC Adapter break open as the result of a fall or other accident, take the product to a Nikon-authorized service representative for inspection, after unplugging the product and/or removing the battery.

Do not use the camera or Charging AC Adapter in the presence of flammable gas

Do not use electronic equipment in the presence of flammable gas, as this could result in explosion or fire.

Handle the camera strap with care

Never place the strap around the neck of an infant or child.

Keep out of reach of children

Particular care should be taken to prevent infants from putting the battery or other small parts into their mouths.

Do not remain in contact with the camera, battery charger, or AC adapter for extended periods while the devices are on or in use.

Parts of the devices become hot. Leaving the devices in direct contact with the skin for extended periods may result in low-temperature burns.

Observe caution when handling the battery

The battery may leak, overheat or explode if improperly handled. Observe the following precautions when handling the battery for use in this product:

- Before replacing the battery, turn the product off. If you are using the Charging AC Adapter/AC adapter, be sure it is unplugged.
- Use only a Rechargeable Li-ion Battery EN-EL19 (included). Charge the battery by using a camera that supports battery charging. To perform this operation, use either Charging AC Adapter EH-69P (included) or the **Charge by computer** function. The Battery Charger MH-66 (available separately) is also available to charge the battery without using a camera.
- When inserting the battery, do not attempt to insert it upside down or backwards.
- Do not short or disassemble the battery or attempt to remove or break the battery insulation or casing.
- Do not expose the battery to flame or to excessive heat.
- Do not immerse in or expose to water.
- Put the battery in the battery case before transporting it. Do not transport or store with metal objects such as necklaces or hairpins.

- The battery is prone to leakage when fully discharged. To avoid damage to the product, be sure to remove the battery when no charge remains.
- Discontinue use immediately should you notice any change in the battery, such as discoloration or deformation.
- If liquid from the damaged battery comes in contact with clothing or skin, rinse immediately with plenty of water.

Observe the following precautions when handling the Charging AC Adapter

- Keep dry. Failure to observe this precaution could result in fire or electric shock.
- Dust on or near the metal parts of the plug should be removed with a dry cloth. Continued use could result in fire.
- Do not handle the plug or go near the Charging AC Adapter during lightning storms. Failure to observe this precaution could result in electric shock.
- Do not damage, modify, forcibly tug or bend the USB cable, place it under heavy objects, or expose it to heat or flames. Should the insulation be damaged and the wires become exposed, take it to a Nikon-authorized service representative for inspection. Failure to observe these precautions could result in fire or electric shock.

- Do not handle the plug or Charging AC Adapter with wet hands. Failure to observe this precaution could result in electric shock.
- Do not use with travel converters or adapters designed to convert from one voltage to another or with DC-to-AC inverters. Failure to observe this precaution could damage the product or cause overheating or fire.

 **Use appropriate cables**

When connecting cables to the input and output jacks, use only the cables provided or sold by Nikon for the purpose, to maintain compliance with product regulations.

 **Handle moving parts with care**

Be careful that your fingers or other objects are not pinched by the lens cover or other moving parts.

 **CD-ROMs**

The CD-ROMs included with this device should not be played back on audio CD equipment. Playing CD-ROMs on an audio CD player could cause hearing loss or damage the equipment.

 **Observe caution when using the flash**

Using the flash close to your subject's eyes could cause temporary visual impairment. Particular care should be observed if photographing infants, when the flash should be no less than one meter (3 ft 4 in.) from the subject.

 **Do not operate the flash with the flash window touching a person or object**

Failure to observe this precaution could result in burns or fire.

 **Avoid contact with liquid crystal**

Should the monitor break, care should be taken to avoid injury caused by broken glass and to prevent liquid crystal from the monitor touching the skin or entering the eyes or mouth.

 **Turn the power off when using inside an airplane or the hospital**

Turn the power off while inside the airplane during take off or landing. Follow the instructions of the hospital when using while in a hospital. The electromagnetic waves given out by this camera may disrupt the electronic systems of the airplane or the instruments of the hospital.

Notices

Notices for Customers in the U.S.A.

IMPORTANT SAFETY INSTRUCTIONS— SAVE THESE INSTRUCTIONS.

DANGER - TO REDUCE THE RISK OF FIRE OR ELECTRIC SHOCK, CAREFULLY FOLLOW THESE INSTRUCTIONS

For connection to a supply not in the U.S.A., use an attachment plug adapter of the proper configuration for the power outlet if needed.

The power supply unit is intended to be correctly orientated in a vertical or floor mount position.

Federal Communications Commission (FCC) Radio Frequency Interference Statement

This equipment has been tested and found to comply with the limits for a Class B digital device, pursuant to Part 15 of the FCC rules. These limits are designed to provide reasonable protection against harmful interference in a residential installation. This equipment generates, uses, and can radiate radio frequency energy and, if not installed and used in accordance with the instructions, may cause harmful interference to radio communications. However, there is no guarantee that interference will not occur in a particular installation. If this equipment does cause harmful interference to radio or television reception, which can be determined by turning the equipment off and on, the user is encouraged to try to correct

the interference by one or more of the following measures:

- Reorient or relocate the receiving antenna.
- Increase the separation between the equipment and receiver.
- Connect the equipment into an outlet on a circuit different from that to which the receiver is connected.
- Consult the dealer or an experienced radio/television technician for help.



Nikon

COOLPIX S3300

CAUTIONS

Modifications

The FCC requires the user to be notified that any changes or modifications made to this device that are not expressly approved by Nikon Corporation may void the user's authority to operate the equipment.

Interface Cables

Use the interface cables sold or provided by Nikon for your equipment. Using other interface cables may exceed the limits of Class B Part 15 of the FCC rules.

Notice for customers in the State of California

WARNING

Handling the cord on this product will expose you to lead, a chemical known to the State of California to cause birth defects or other reproductive harm.

Wash hands after handling.

Nikon Inc.,
1300 Walt Whitman Road
Melville, New York 11747-3064
USA
Tel: 631-547-4200

Notice for customers in Canada

CAUTION

This Class B digital apparatus complies with Canadian ICES-003.

ATTENTION

Cet appareil numérique de la classe B est conforme à la norme NMB-003 du Canada.

Notices for customers in Europe

CAUTIONS

RISK OF EXPLOSION IF BATTERY IS REPLACED BY AN INCORRECT TYPE.

DISPOSE OF USED BATTERIES ACCORDING TO THE INSTRUCTIONS.

This symbol indicates that this product is to be collected separately.

The following apply only to users in European countries:

- This product is designated for separate collection at an appropriate collection point. Do not dispose of as household waste.
- For more information, contact the retailer or the local authorities in charge of waste management.

This symbol on the battery indicates that the battery is to be collected separately.





The following apply only to users in European countries:















































- All batteries, whether marked with this symbol or not, are designated for separate collection at an appropriate collection point. Do not dispose of as household waste.
- For more information, contact the retailer or the local authorities in charge of waste management.















































Table of Contents

Introduction	ii
Read This First	ii
Confirming the Package Contents	ii
About This Manual	iii
Information and Precautions	iv
For Your Safety	vi
WARNINGS	vi
Notices	ix
Parts of the Camera and Basic Operation	1
Parts of the Camera	2
The Camera Body	2
Camera Controls Used in Shooting Mode	4
Camera Controls Used in Playback Mode	5
The Monitor	6
Basic Operations	8
Switching Between Shooting Mode and Playback Mode	8
Using the Multi Selector	9
Using Menus (the MENU Button)	10
Attaching the Camera Strap	11
Basic Steps for Shooting and Playback	13
Preparation 1 Insert the Battery	14
Preparation 2 Charge the Battery	16
Preparation 3 Insert a Memory Card	18
Internal Memory and Memory Cards	19
Approved Memory Cards	19
Step 1 Turn the Camera On	20
Turning the Camera On and Off	21
Setting Display Language, Date and Time	22
Step 2 Select a Shooting Mode	24
Available Shooting Modes	25
Step 3 Frame a Picture	26
Using the Zoom	27
Step 4 Focus and Shoot	28
Step 5 Play Back Images	30
Changing How Images Are Displayed	31
Step 6 Delete Unwanted Images	32
Shooting Features	35
📷 (Auto) Mode	36

Changing  (Auto) Mode Settings	36
Shooting Menu Options in  (Auto) Mode	37
Scene Mode (Shooting Suited to Scenes)	39
Changing Scene Mode Settings	39
Scene Mode and Features	40
Special Effects Mode (Applying Effects When Shooting)	47
Changing Special Effects Mode Settings	48
Smart Portrait Mode (Capturing Images of Smiling Faces)	49
Changing Smart Portrait Mode Settings	51
Smart Portrait Menu Options	51
Features That Can Be Set Using the Multi Selector	52
Functions Available for Each Shooting Mode	52
Using the Flash (Flash Modes)	53
Using the Self-timer	55
Using Macro Mode	56
Adjusting Brightness (Exposure Compensation)	57
Default Settings	58
Changing the Image Size (Image Mode)	60
Image Mode Settings (Image Size and Quality)	60
Functions That Cannot Be Applied Simultaneously	62
Face Detection	64
Skin Softening	66
Focus Lock	67
<hr/>	
Playback Features	69
Selecting Certain Types of Images for Playback	70
Available Playback Modes	70
Switching Between Playback Modes	70
Functions Available in Playback Mode (Playback Menu)	71
Connecting the Camera to a Television, Computer, or Printer	72
Using ViewNX 2	73
Installing ViewNX 2	73
Transferring Images to the Computer	75
Viewing Images	76
<hr/>	
Recording and Playing Back Movies	77
Recording Movies	78
Changing Movie Recording Settings (The Movie Menu)	81
Movie Playback	82
Operation during Movie Playback	82
Deleting a Movie File	83

General Camera Setup.....	85
The Setup Menu	86
Reference Section	 1
Using Panorama Assist.....	 2
Favorite Pictures Mode	 4
Adding Images to Albums.....	 4
Viewing Images in an Album	 5
Removing Images from Albums	 5
Changing Icons Assigned to Albums.....	 6
Auto Sort Mode	 7
List by Date Mode	 9
Editing Images (Still Images).....	 10
Editing Functions.....	 10
 Quick Retouch: Enhancing Contrast and Saturation.....	 12
 D-Lighting: Enhancing Brightness and Contrast	 12
 Glamour Retouch: Softening Skin and Making Faces Looking Smaller with Larger Eyes.....	 13
 Filter Effects: Applying Digital Filter Effects.....	 14
 Small Picture: Reducing Image Size	 15
 Crop: Creating a Cropped Copy.....	 16
Connecting the Camera to a TV (Playback on a TV)	 17
Connecting the Camera to a Printer (Direct Print).....	 18
Connecting the Camera to a Printer.....	 19
Printing Images One by One	 20
Printing Multiple Images.....	 21
The Shooting Menu (for  (Auto) Mode)	 24
White Balance (Adjusting Hue)	 24
Continuous.....	 26
ISO Sensitivity.....	 28
Color Options.....	 29
AF Area Mode	 30
Autofocus Mode.....	 33
Smart Portrait Menu.....	 34
Skin Softening	 34
Smile Timer	 34
Blink Proof.....	 35
The Playback Menu	 36
 Print Order (Creating a DPOF Print Order)	 36
 Slide Show.....	 40
 Protect	 41

 Rotate Image	 43
 Voice Memo.....	 44
 Copy (Copy Between Internal Memory and Memory Card)	 46
The Movie Menu.....	 47
Movie Options	 47
Autofocus Mode.....	 48
Wind Noise Reduction	 48
The Setup Menu	 49
Welcome Screen	 49
Time Zone and Date.....	 50
Monitor Settings.....	 53
Print Date (Imprinting Date and Time).....	 55
Vibration Reduction	 56
Motion Detection	 57
AF Assist.....	 58
Digital Zoom	 58
Sound Settings.....	 59
Auto Off	 59
Format Memory/Format Card	 60
Language.....	 61
Video Mode	 61
Charge by Computer.....	 62
Blink Warning	 64
Eye-Fi Upload	 66
Reset All	 67
Firmware Version	 69
Image/Sound File and Folder Names	 70
Optional Accessories	 71
Error Messages	 72

Technical Notes and Index.....	 1
Maximizing Camera Life and Performance.....	 2
The Camera	 2
The Battery.....	 4
Charging AC Adapter.....	 5
Memory Cards	 5
Cleaning	 6
Storage.....	 6
Troubleshooting.....	 7
Specifications	 14
Supported Standards	 17
Index.....	 18



Parts of the Camera and Basic Operation

This chapter describes the parts of the camera and also explains how to use basic camera features.

Parts of the Camera	2
The Camera Body	2
Camera Controls Used in Shooting Mode	4
Camera Controls Used in Playback Mode	5
The Monitor	6
Basic Operations	8
Switching Between Shooting Mode and Playback Mode	8
Using the Multi Selector	9
Using Menus (the MENU Button)	10
Attaching the Camera Strap	11

➡ If you want to start using the camera right away, see “Basic Steps for Shooting and Playback” (📖13).

Parts of the Camera



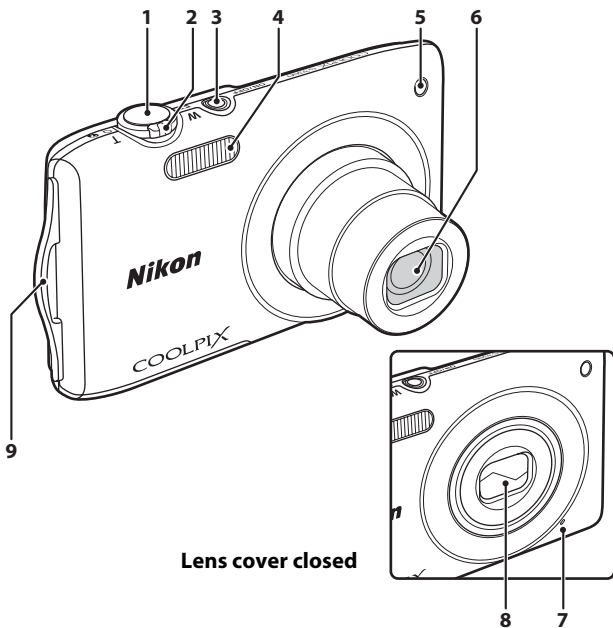





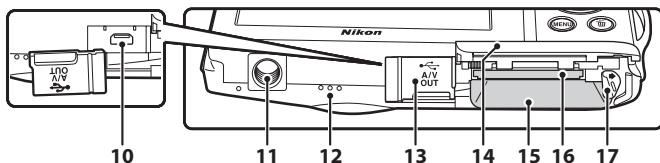
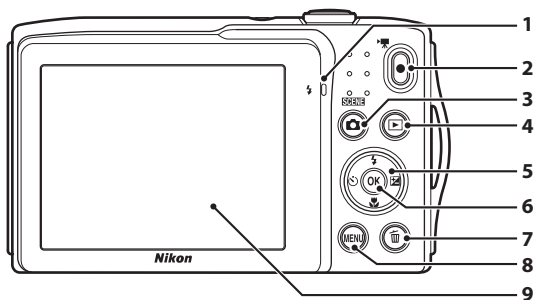



The Camera Body











Lens cover closed

1	Shutter-release button.....4, 5, 28	4	Flash.....53
2	Zoom control.....4, 5, 27	5	Self-timer lamp55
	W : Wide-angle.....4, 27	6	AF-assist illuminator.....87
	T : Telephoto.....4, 27	7	Lens
	: Thumbnail playback.....5, 31	8	Built-in microphone.....78, 44
	: Playback zoom.....5, 31	9	Lens cover.....2
	: Help.....39		
3	Power switch/power-on lamp		
20, 21		



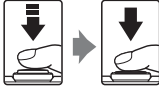











1	Charge lamp.....17,  63 Flash lamp..... 53	10	USB/audio/video output connector 16, 72,  17,  19
2	 (movie-record) button.....4, 5, 78	11	Tripod socket.....  15
3	 (shooting mode) button4, 5, 8, 24	12	Speaker 82,  44
4	 (playback) button4, 5, 8, 30, 70	13	Connector cover 16, 72,  17,  19
5	Multi selector 9	14	Battery-chamber/ memory card slot cover 14, 15
6	 (apply selection) button5, 9	15	Battery chamber.....14
7	 (delete) button4, 5, 32, 83,  45	16	Memory card slot.....18
8	MENU button.....4, 5, 10, 36, 71, 81, 86	17	Battery latch.....14
9	Monitor6, 24		

Camera Controls Used in Shooting Mode

Control	Name	Main function	
	Shooting mode button	Changes the shooting mode (displays the shooting mode selection screen).	24
	Zoom control	Zooms in and out; rotate to T (Q) to zoom in, and rotate to W (checkered) to zoom out.	27
	Multi selector	See “Using the Multi Selector” for more information.	9, 10
	Menu button	Displays or hides the menu.	10, 37, 81, 86
	Shutter-release button	When pressed halfway (i.e., if you stop pressing when you feel a slight resistance): Sets focus and exposure. When pressed all the way: Releases the shutter.	28
	Movie-record button	Starts or stops movie recording.	78
	Playback button	Plays back images.	30, 70, 82
	Delete button	Deletes the last image that was saved.	32

Camera Controls Used in Playback Mode

Control	Name	Main function	
	Playback button	<ul style="list-style-type: none"> Changes the playback mode (displays the playback mode selection screen). When the camera is off, press and hold this button to turn the camera on in playback mode. 	70 21
	Zoom control	<ul style="list-style-type: none"> When displaying images, rotate to T (Q) to magnify the image, and rotate to W (checkered) to display image thumbnails or the calendar. Adjusts the volume. 	31 82
	Multi selector	See "Using the Multi Selector" for more information.	9, 10
	Apply selection button	<ul style="list-style-type: none"> Switches from image thumbnail or zoomed image display to full-frame display. Adds or removes favorite pictures. Plays back movies. 	31  4,  5 82
	Menu button	Displays or hides the menu.	10, 71, 86
	Delete button	Deletes images.	32
	Shooting mode button	Switches to shooting mode.	–
	Shutter-release button		–
	Movie-record button		–

The Monitor

The information that is displayed in the monitor during shooting and playback changes depending on the camera's settings and state of use. At the default setting, the indicators below are displayed when the camera is turned on or is in operation, and they disappear after a few seconds elapse (when **Photo info** is set to **Auto info** in **Monitor settings** (86)).

Shooting Mode

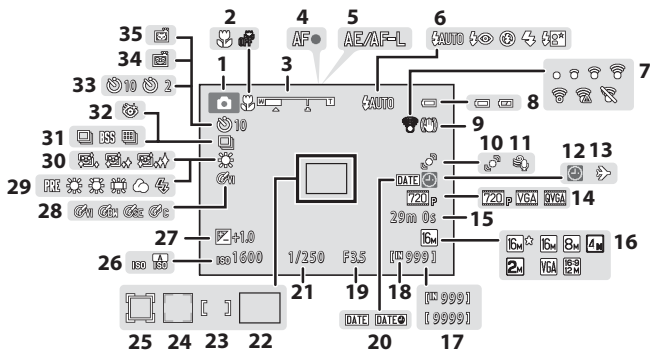

1	Shooting mode	24, 36, 39, 47, 49	19	Aperture value.....	28
2	Macro mode	56	20	Print date	86, 86, 86
3	Zoom indicator.....	27, 56	21	Shutter speed	28
4	Focus indicator	28	22	Focus area (auto).....	28, 38, 38
5	AE/AF-L indicator	3	23	Focus area (for manual or center)	
6	Flash mode.....	53		Focus area (face detection, pet	31
7	Eye-Fi communication indicator		24	detection).....	28, 38, 46, 49, 38
	88, 86	25	Focus area (subject tracking)	
8	Battery level indicator.....	20		38, 38
9	Vibration reduction icon.....	87, 86	26	ISO sensitivity.....	37, 38
10	Motion detection icon	87, 86	27	Exposure compensation value	57
11	Wind noise reduction	81, 86	28	Color options	38, 38
12	"Date not set" indicator		29	White balance mode.....	37, 38
	22, 50, 72	30	Skin softening	51, 38
13	Travel destination.....	86, 86	31	Continuous shooting mode	
14	Movie options	81, 86		37, 38
15	Movie length.....	78	32	Blink proof.....	51, 38
16	Image mode.....	60	33	Self-timer indicator.....	55
17	Number of exposures remaining		34	Smile timer.....	51, 38
	(still images).....	20	35	Pet portrait auto release.....	46, 55
18	Internal memory indicator.....	20			

Playback Mode

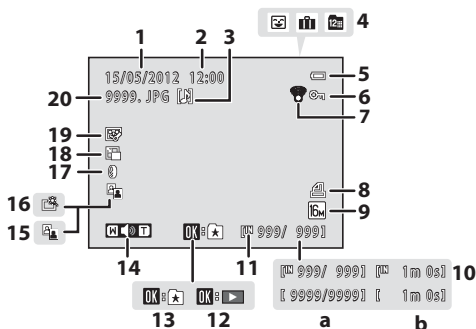



1	Date of recording.....	22
2	Time of recording.....	22
3	Voice memo icon.....	71,
4	Album icon in favorite pictures mode.....	70,
	Category icon in auto sort mode.....	70,
	List by date icon.....	70,
5	Battery level indicator.....	20
6	Protect icon.....	71,
7	Eye-Fi communication indicator	88,
8	Print order icon.....	71,
9	Image mode.....	60
	Movie options.....	81,

a	Current frame number/ total number of frames.....	30
b	Movie length.....	82
11	Internal memory indicator.....	30
12	Movie playback guide.....	82
13	Add to album guide.....	
14	Volume indicator.....	82,
15	D-Lighting icon.....	71,
16	Quick retouch icon.....	71,
17	Filter effects icon.....	71,
18	Small picture icon.....	71,
19	Glamour retouch icon.....	71,
20	File number and type.....	

Basic Operations



Switching Between Shooting Mode and Playback Mode

The camera has two modes of operation: Shooting mode, which is used for taking pictures, and playback mode, which is used for viewing pictures.

While using shooting mode, press the  (playback) button to switch to playback mode; while using playback mode, press the  (shooting mode) button to switch to shooting mode.

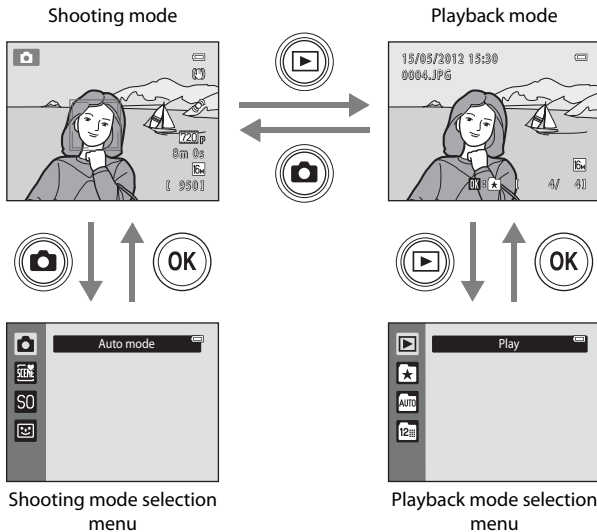
- While using playback mode, you can also switch to shooting mode by pressing the shutter-release button or the  ( movie-record) button.



- If you press the  (shooting mode) button while the shooting screen is displayed, the shooting mode selection menu is displayed, from which you can select one of the available shooting modes (📖24).
- If you press the  (playback) button while the playback screen is displayed, the playback mode selection menu is displayed, from which you can select one of the available playback modes (📖70).

Using the Multi Selector

Operate by pressing the multi selector up (▲), down (▼), left (◀), or right (▶), or pressing the **OK** button.

Shooting Mode

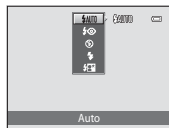
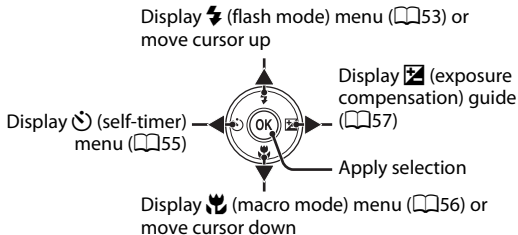

Playback Mode

Select previous image or move the displayed area when the image is magnified (📖31)

Add image to album, remove image from album (📖70, 📖84, 📖85), or play back movies (📖82)*

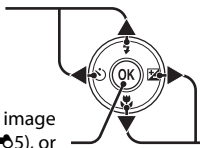

Select next image or move the displayed area when the image is magnified (📖31)

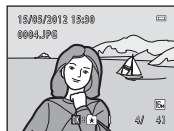

* When displaying image thumbnails or when the image is magnified, this button switches the camera to full-frame display.

Menu Screen

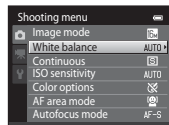
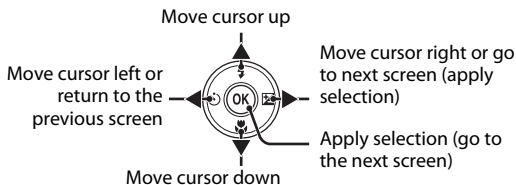

Using Menus (the MENU Button)

If you press the **MENU** button while the shooting screen or playback screen is displayed, the MENU for the current mode is displayed. Once the menu is displayed, you can change various settings.

Shooting mode

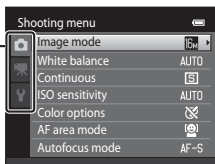
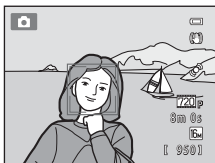

Tabs

Playback mode

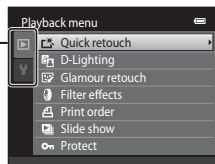
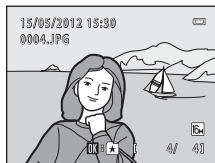

Tabs



tab:

Displays the settings that can be changed for the current shooting mode (124). Depending on the current shooting mode, the tab icon that is displayed will be different.



tab:

Displays the settings that deal with movie recording.



tab:

Displays the setup menu, where you can change general settings of the camera.



tab:

Displays the settings that can be changed for the current playback mode (170). Depending on the current playback mode, the tab icon that is displayed will be different.



tab:

Displays the setup menu, where you can change general settings of the camera.

If Tabs are not Displayed

If you press the **MENU** button and the screen that allows you to change the image mode is displayed, press the multi selector  to display the tabs.

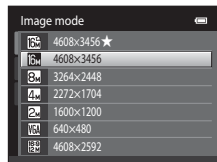



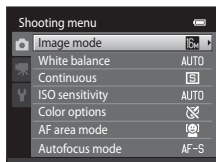

Switching Between Tabs

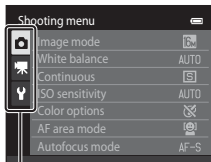

Press the multi selector  to highlight the tab.





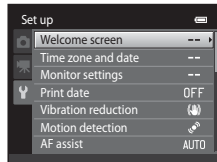

Press the multi selector  or  to select a tab, and press either the  button or .



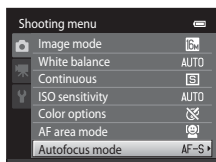



The selected menu is displayed.

Selecting Items

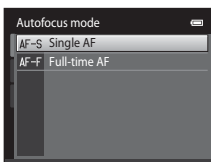

Select an item with the multi selector  or  and press either  or the  button.



Select an item with  or  and press the  button.



When you finish changing the settings, press the MENU button to exit the menu.

When the Menu Contains Two or More Pages

The scroll bar is displayed when all of the menu items do not fit on one screen.

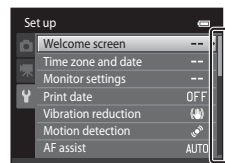

Attaching the Camera Strap

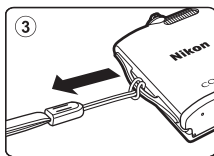
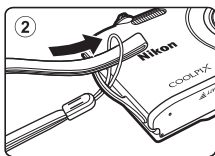
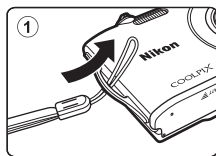



A series of horizontal dashed lines spanning the width of the page, intended for handwriting practice.



Basic Steps for Shooting and Playback

Preparation

Preparation 1 Insert the Battery	14
Preparation 2 Charge the Battery	16
Preparation 3 Insert a Memory Card	18



Shooting

Step 1 Turn the Camera On	20
Setting Display Language, Date and Time (First Use Only)	22
Step 2 Select a Shooting Mode	24
Step 3 Frame a Picture	26
Step 4 Focus and Shoot	28



Playback

Step 5 Play Back Images	30
Step 6 Delete Unwanted Images	32

Preparation 1 Insert the Battery

- 1** Open the battery-chamber/memory card slot cover.

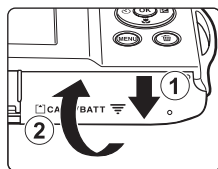

- 2** Insert the included Rechargeable Li-ion Battery EN-EL19.

- Use the battery to push the orange battery latch in the direction indicated by the arrow (1) and fully insert the battery (2).
- When the battery is properly inserted, the battery latch will lock it in place.

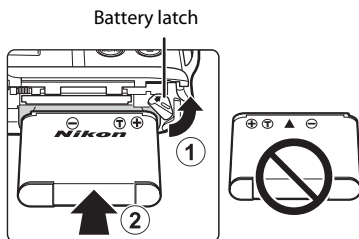

✓ **Inserting the Battery Correctly**

Inserting the battery upside down or backwards could damage the camera. Be sure to check that the battery is in the correct orientation.

- 3** Close the battery-chamber/memory card slot cover.

- Charge the battery before first use or when it is running low. See page 16 for more information.

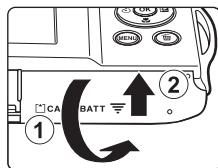

Removing the Battery

Turn the camera off and be sure that the power-on lamp and the monitor have turned off and open the battery-chamber/memory card slot cover.

Push the orange battery latch in the direction indicated by the arrow (①) to partially eject the battery. Pull the battery straight out of the camera (②); do not pull it at an angle.

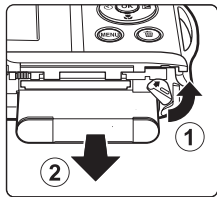

High Temperature Caution

The camera, battery, and memory card may be hot immediately after using the camera. Observe caution when removing the battery or memory card.

Note About the Battery

Be sure to read and follow the warnings for the battery on page vii and the section “The Battery” (C:4), before use.

Preparation 2 Charge the Battery

1 Prepare the included Charging AC Adapter EH-69P.

- If a plug adapter* is included, attach the plug adapter to the plug on the Charging AC Adapter. Push the plug adapter firmly until it is securely held in place. Once the two are connected, attempting to forcibly remove the plug adapter could damage the product.

* The shape of the plug adapter varies according to the country or region in which the camera was purchased. The Charging AC Adapter comes with the plug adapter attached in Argentina and Korea.

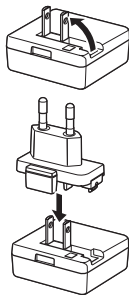

2 Make sure the battery is installed in the camera, and then connect the camera to the Charging AC Adapter in order of ① to ③.

- Keep the camera turned off.
- Be sure that plugs are properly oriented. Do not attempt to insert plugs at an angle, and do not use force when connecting or disconnecting the plugs.

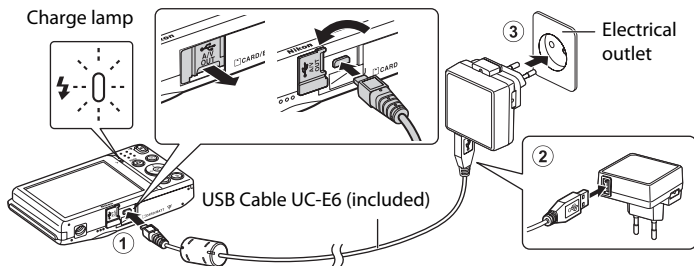

- The charge lamp slowly flashes green to indicate that the battery is charging.
- About 2 hours and 30 minutes are required to charge a fully exhausted battery.
- When the battery has been completely charged, the charge lamp turns off.
- See "Understanding the Charge Lamp" (📖17) for more information.

3 Disconnect the Charging AC Adapter from the electrical outlet and then disconnect the USB cable.

- When the camera is connected to the electrical outlet with the EH-69P, the camera cannot be turned on.

Understanding the Charge Lamp

Charge lamp	Description
Flashes slowly (green)	Battery charging.
Off	Battery not charging. When charging is complete, the charge lamp stops flashing green and turns off.
Flashes quickly (green)	<ul style="list-style-type: none"> The ambient temperature is not suited to charging. Charge the battery indoors with an ambient temperature of 5°C to 35°C (41°F to 95°F). The USB cable or Charging AC Adapter is not properly connected, or there is a problem with the battery. Disconnect the USB cable or unplug the Charging AC Adapter and correctly connect it again, or change the battery.

Note About Charging AC Adapter

Be sure to read and follow the warnings for the Charging AC Adapter on page vii and the section, "Charging AC Adapter" (75) before use.

Charging Using Computer or Battery Charger

- Connecting the COOLPIX S3300 to a computer also charges the Rechargeable Li-ion Battery EN-EL19 (72, 62).
- Rechargeable Li-ion Battery EN-EL19 can also be charged using the Battery Charger MH-66 (available separately; 71).

AC Power Supply

- If the AC Adapter EH-62G (available separately; 71) is used, COOLPIX S3300 can be powered from an electrical outlet and operated for shooting or playback.
- Do not, under any circumstances, use another make or model of AC adapter other than the EH-62G. Failure to observe this precaution could result in overheating or in damage to the camera.

Preparation 3 Insert a Memory Card

- 1 Be sure that the power-on lamp and the monitor are off and open the battery-chamber/memory card slot cover.
 - Be sure to turn off the camera before opening the cover.

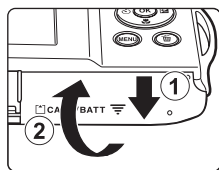

- 2 Insert the memory card.
 - Slide the memory card in correctly until it clicks into place.

- ✓ Inserting the Memory Card**
Inserting the memory card upside down or backwards could damage the camera or the memory card. Be sure to check that the memory card is in the correct orientation.

Memory card slot

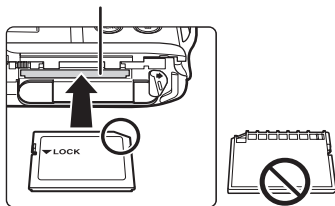

- 3 Close the battery-chamber/memory card slot cover.

✓ Formatting a Memory Card

- The first time you insert a memory card that has been used in another device into this camera, be sure to format it with this camera.
- **All data stored on a memory card is permanently deleted when the card is formatted.** Be sure to transfer important images to a computer and save them before formatting.
- To format a memory card, insert the memory card into the camera, press the **MENU** button and select **Format card** (📖88) from the setup menu (📖86).

✓ Note About Memory Cards

Refer to the documentation included with the memory card, as well as “Memory Cards” (🔗5) in “Maximizing Camera Life and Performance”.

Removing Memory Cards

Turn the camera off and be sure that the power-on lamp and the monitor have turned off and open the battery-chamber/memory card slot cover.

Gently push the memory card into the camera (①) to partially eject the card. Pull the memory card straight out of the camera (②); do not pull it at an angle.

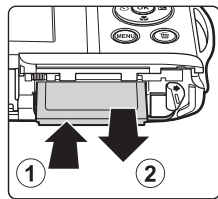

High Temperature Caution

The camera, battery, and memory card may be hot immediately after using the camera. Observe caution when removing the battery or memory card.

Internal Memory and Memory Cards

Camera data, including still images and movies, can be saved in either the camera's internal memory (approximately 42 MB) or on a memory card. To use the camera's internal memory for shooting or playback, first remove the memory card.

Approved Memory Cards

The following Secure Digital (SD) memory cards have been tested and approved for use in this camera.

- Memory cards with an SD Speed Class rating of 6 or faster are recommended for recording movies. Movie recording may stop unexpectedly when memory cards with a lower Speed Class rating are used.

	SD memory card	SDHC memory card ²	SDXC memory card ³
SanDisk	2 GB ¹	4 GB, 8 GB, 16 GB, 32 GB	64 GB
TOSHIBA	2 GB ¹	4 GB, 8 GB, 16 GB, 32 GB	64 GB
Panasonic	2 GB ¹	4 GB, 8 GB, 12 GB, 16 GB, 32 GB	48 GB, 64 GB
Lexar	–	4 GB, 8 GB, 16 GB, 32 GB	64 GB, 128 GB

¹ If the memory card is used with a card reader or similar device, make sure that the device supports 2 GB cards.

² SDHC compliant. If the memory card is used with a card reader or similar device, be sure that the device is compliant with the SDHC standard.

³ SDXC compliant. If the memory card is used with a card reader or similar device, be sure that the device is compliant with the SDXC standard.



- Contact the manufacturer for details on the above cards. We cannot guarantee camera performance when using memory cards made by other manufacturers.

Step 1 Turn the Camera On

1 Press the power switch to turn on the camera.

- **If you are turning the camera on for the first time after purchase, see “Setting Display Language, Date and Time”** (📖22).
- The lens extends and the monitor turns on.

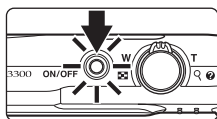

2 Check the battery level indicator and the number of exposures remaining.

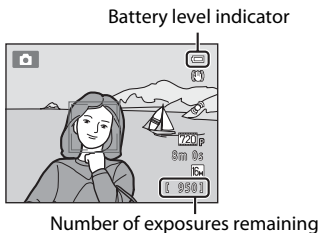

Battery level indicator	Description
	Battery level is high.
	Battery level is low. Prepare to charge or replace the battery.
 Battery exhausted.	The camera cannot take pictures. Charge or replace the battery.

Number of Exposures Remaining

The number of images that can be captured is displayed.

- If a memory card is not inserted, **IN** is displayed to indicate that images will be saved in the camera's internal memory (approximately 42 MB).
- The number of exposures remaining depends on the remaining capacity of the internal memory or memory card, and the image quality and image size (image mode) (📖61).
- The number of exposures remaining shown in the illustrations may differ from the actual display.



Turning the Camera On and Off

- When the camera is turned on, the power-on lamp (green) will light, and then the monitor will turn on (the power-on lamp turns off when the monitor turns on).
- To turn off the camera, press the power switch. When the camera is turned off, both the power-on lamp and the monitor turn off.
- To turn on the camera in playback mode, press and hold the  (playback) button. The lens will not extend.

Power Saving Function (Auto Off)

If no operations are performed for a while, the monitor will turn off, the camera will enter standby mode, and the power-on lamp will flash. If no operations are performed for approximately another three minutes, the camera will turn off automatically.

To reactivate the monitor while the power-on lamp is flashing, press any of the following buttons:

- Power switch, shutter-release button,  (shooting mode) button,  (playback) button, or  (movie-record) button.

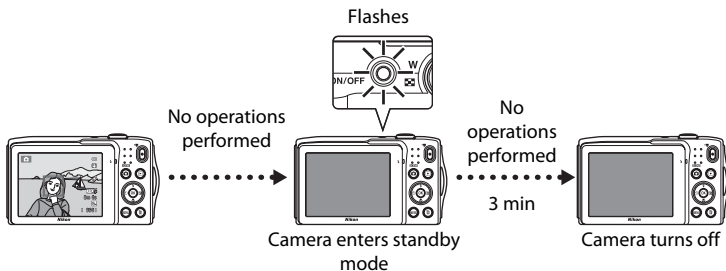

- The time allowed to elapse before the camera enters standby mode can be changed from the **Auto off** option (📖87) in the setup menu (📖86).
- By default, the camera enters standby mode in about one minute when you are using shooting mode or playback mode.
- When the AC Adapter EH-62G (available separately) is used, the camera enters standby mode after 30 minutes (fixed).

Setting Display Language, Date and Time

A language-selection dialog is displayed the first time the camera is turned on.

- 1 Press the multi selector ▲ or ▼ to choose the desired language and press the OK button.

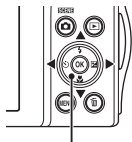

Multi selector

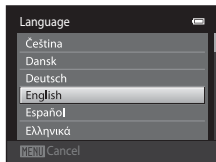

- 2 Press ▲ or ▼ to choose Yes and press the OK button.

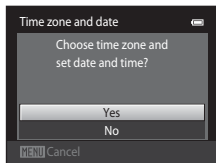

- 3 Press ◀ or ▶ to select your home time zone and press the OK button.

- For information about "Daylight Saving Time", see page 23.

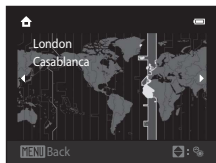

- 4 Press the ▲ or ▼ to choose the order in which the day, month and year are displayed and press the OK button or ▶.

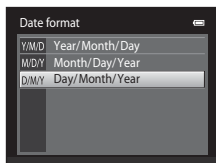

- 5 Press ▲, ▼, ◀, or ▶ to edit the date and time and press the OK button.

- Select a field: Press ▶ or ◀ (the highlight switches between **D**, **M**, **Y**, hour, and minute).
- Edit the value: Press ▲ or ▼.
- Confirm the settings: Select the minute field and press the OK button or ▶.

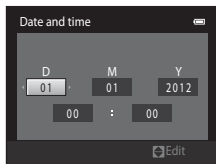

6 Press ▲ or ▼ to choose **Yes** and press the **OK** button.

- When the settings are applied, the lens extends and the monitor display exits to shooting mode.

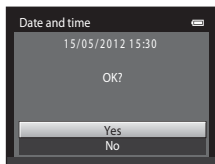



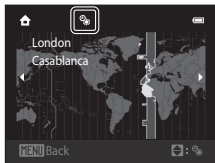

Daylight Saving Time

If daylight saving time is in effect, press ▲ to enable the daylight saving time function while setting the region in step 3.

- When the daylight saving time function is enabled,  is displayed at the top of the monitor. To turn off the daylight saving time function, press ▼.





Changing the Language or the Date and Time Setting

- You can change these settings using the **Language** and **Time zone and date** settings in the setup menu (86).
- When the daylight saving time function is enabled in **Time zone** in **Time zone and date** in the setup menu, the camera clock moves forward one hour, and when it is disabled, it moves back one hour. When the travel destination () is selected, the camera automatically calculates the time difference between the travel destination and the home time zone () and saves images using the date and time of the travel destination.
- If you exit without setting the date and time,  will flash when the shooting screen is displayed. Use the **Time zone and date** setting in the setup menu to set the date and time (86).

The Clock Battery

- The camera clock is powered by the backup battery that is separate from the camera's main battery.
- The backup battery charges when the main battery is inserted into the camera or when the camera is connected to an optional AC adapter, and can provide several days of backup power after about ten hours of charging.
- If the backup battery becomes exhausted, the date and time setting screen is displayed when the camera is turned on. Set the date and time again. See "Setting Display Language, Date and Time" (step 2, 22) for more information.

Imprinting the Shooting Date in Printed Images

- Set the date and time before shooting.
- You can permanently imprint the shooting date on images as they are captured by setting **Print date** in the setup menu (86).
- You can use the ViewNX 2 software (73) to print the shooting date on images that were captured without using the **Print date** option.



Step 2 Select a Shooting Mode

1 Press the button.

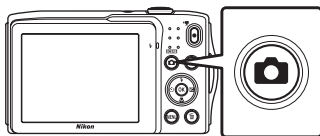
- The shooting mode selection menu, which allows you to select the desired shooting mode, is displayed.



2 Press the multi selector or to choose a shooting mode.

-  (auto) mode is used in this example. Select  **Auto mode**.

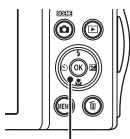

Multi selector

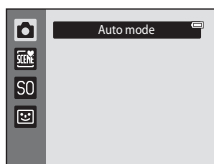





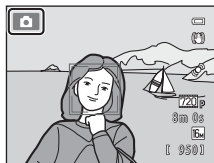









3 Press the button.





- The camera enters  (auto) mode.
- See "The Monitor" (book icon) for more information about the shooting screen.
- The shooting mode setting is saved even after the camera is turned off.



Available Shooting Modes

	Auto mode 📖 36
Used for general shooting. Settings can be adjusted in the shooting menu (📖 37) to suit the shooting conditions and the type of shot you want to capture.	
	Scene 📖 39
Camera settings are automatically optimized for the selected scene. When using scene auto selector, the camera automatically selects the optimum scene mode when you frame a picture, making it even easier to take pictures using settings that suit the scene.	
<ul style="list-style-type: none"> To select a scene, first display the shooting mode selection menu and then press the multi selector . Select the desired scene by pressing , , , or , and then press the  button. 	
S0	Special effects 📖 47
Effects can be applied to images during shooting. Six different effects are available.	
<ul style="list-style-type: none"> To select an effect, first display the shooting mode menu and then press the multi selector . Select the desired effect by pressing , , , or , and then press the  button. 	
	Smart portrait 📖 49
When the camera detects a smiling face, you can take a picture automatically without pressing the shutter-release button (Smile timer). The skin softening option can be used to make skin tones of human faces appear smoother.	

Features That Are Available in Each Shooting Mode

- The multi selector , , , and  can be used to set the corresponding features. See “Features That Can Be Set Using the Multi Selector” (📖 52) for more information.
- When using shooting mode, press the **MENU** button to display the menu for the selected shooting mode. See “Shooting Features” (📖 35) for information about the settings available in the menu for the current shooting mode.

Step 3 Frame a Picture

1 Hold the camera steadily in both hands.

- Keep fingers and other objects away from the lens, flash, AF assist-illuminator, microphone, and speaker.
- When taking pictures in portrait (“tall”) orientation, turn the camera so that the built-in flash is above the lens.

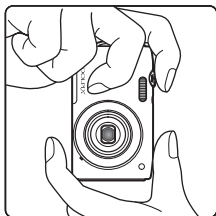
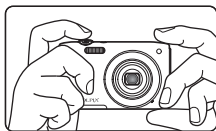

2 Frame the picture.

- When the camera detects a face, that face will be framed by a yellow double border (focus area) (default setting).
- Up to 12 faces can be detected. If more than one face is detected, the face closest to the camera will be framed by a double border, and the others by a single border.
- When taking pictures of subjects other than people, or framing a subject with which no face is detected, a focus area will not be displayed. Frame the picture so that the intended subject is at or near the center of the frame.

Shooting mode icon

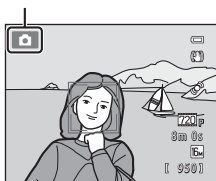

Using a Tripod

- We recommend using a tripod to stabilize the camera when shooting in the following situations:
 - When shooting in dim lighting or when the flash mode (📖54) is set to  (Off).
 - When using the telephoto setting.
- Set **Vibration reduction** to **Off** in the setup menu (📖86) when using a tripod to stabilize the camera during shooting.

Using the Zoom

Use the zoom control to activate optical zoom.

- Rotate the zoom control to **T** to zoom in so that the subject fills a larger area of the frame.
- Rotate the zoom control to **W** to zoom out, thus increasing the area visible in the frame.
- The zoom position is set at the maximum wide-angle position when the camera is turned on.
- A zoom indicator is displayed at the top of the monitor when the zoom control is rotated.

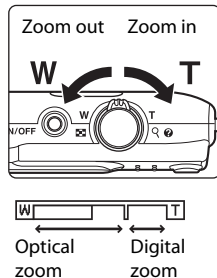

Digital Zoom



When the camera is zoomed in to the maximum optical zoom position, rotating and holding the zoom control at **T** triggers digital zoom. The subject is magnified up to 4x the maximum optical zoom ratio.



- The camera focuses at the center of the frame and the focus area is not displayed when digital zoom is in effect.

Digital Zoom and Interpolation

Unlike optical zoom, digital zoom uses a digital imaging process known as interpolation to magnify images, resulting in slight deterioration of image quality according to the image mode (86) and digital zoom magnification.

Interpolation is applied at zoom positions beyond  when taking still images. When zoom is increased beyond the  position, interpolation is initiated and the zoom indicator turns yellow to indicate that interpolation is being applied.  moves to the right as the image size becomes smaller, allowing you to confirm the zoom position that can be used to capture still images without image degradation before shooting at the current image size setting.



- Digital zoom can be disabled from the **Digital zoom** option (87) in the setup menu (86).

Step 4 Focus and Shoot

1 Press the shutter-release button halfway, i.e., press the button lightly until you feel a slight resistance.

- When you press the shutter-release button halfway, the camera sets focus and exposure (shutter speed and aperture value). Focus and exposure remain locked while the shutter-release button is pressed halfway.
- When a face is detected, it is framed by the double border indicating the active focus area. When the subject is in focus, the double border turns green.

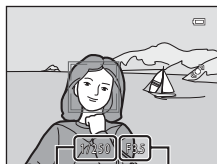
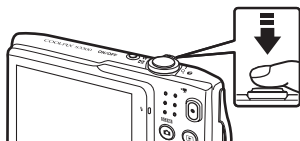

Shutter speed Aperture value

- When a face is not detected, camera automatically selects the focus area (up to nine) containing the subject closest to the camera. When the subject is in focus, the focus area that is selected glows green.

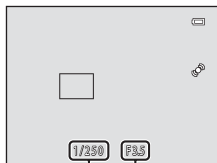

Shutter speed Aperture value

- When digital zoom is used, the focus area is not displayed and the camera focuses at the center of the frame. Once focus has been acquired, the focus indicator (📖6) will glow green.
- If the focus area or the focus indicator flashes red when the shutter-release button is pressed halfway, the camera is unable to focus. Modify the composition and press the shutter-release button halfway again.

2 Press the shutter-release button all the way, i.e., press the button the rest of the way down.

- The shutter is released and the image will be recorded to the memory card or internal memory.
- If you press the shutter-release button with too much force, the camera may shake, causing images to be blurred. Press the button gently.



✔ Note on Recording Images and Saving Movies

The indicator showing the number of exposures remaining or the indicator showing the maximum movie length flashes while images are being recorded or while a movie is being saved. **Do not open the battery-chamber/memory card slot cover or remove the battery or memory card** while an indicator is flashing. Doing this could result in loss of data, or in damage to the camera or the memory card.

✔ Subjects Not Suitable for Autofocus

Autofocus may not perform as expected in the following situations. In some rare cases, the subject may not be in focus despite the fact that the focus area or the focus indicator glows green:

- Subject is very dark
- Objects of sharply differing brightness are included in the scene (e.g. the sun behind the subject makes that subject appear very dark)
- No contrast between the subject and surroundings (e.g. a portrait subject, wearing a white shirt, is standing in front of a white wall)
- Several objects are at different distances from the camera (e.g. the subject is inside a cage)
- Regular geometric patterns (e.g. window blinds or windows on a skyscraper)
- Subject is moving rapidly

In the situations noted above, try pressing the shutter-release button halfway to refocus several times, or focus on another subject in auto mode and use focus lock (📖67). When using focus lock, be sure that the distance between the camera and the subject with which focus was locked is the same as that for the actual subject.

✔ Note About Face Detection

See “Face Detection” (📖64) for more information.

✍ When the Subject Is Close to the Camera

If the camera cannot focus, try shooting with macro mode (📖56) or the **Close-up** scene mode (📖43).

✍ AF-assist Illuminator and Flash

If the subject is poorly lit, the AF-assist illuminator (📖87) may light when the shutter-release button is pressed halfway, or the flash (📖53) may fire when the shutter-release button is pressed all the way down.

✍ To Make Sure You Do Not Miss a Shot

If you are concerned that you might miss a shot, press the shutter-release button all the way without first pressing it halfway.







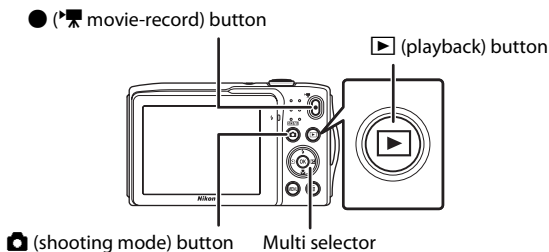



Step 5 Play Back Images

1 Press the (playback) button.

- The camera enters playback mode, and the last image captured is displayed in full-frame playback mode.





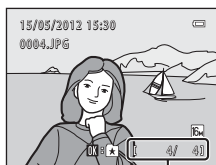

2 Use the multi selector to select an image to display.

- Press  or  to view the previous image.
- Press  or  to view the next image.
- To scroll quickly through images, press and hold the multi selector , , , or .
- To play back images that are saved in the internal memory, remove the memory card.  is displayed in the current frame number/total number of frames area.
- To return to shooting mode, press the  button, the shutter-release button, or the  button.





Current frame number/
total number of frames

Viewing Images

- Images may be displayed briefly at low resolution immediately after switching to the next or previous image.
- If you are viewing an image that was captured using face detection (64) or pet detection (46), the image will be rotated and displayed automatically in full-frame playback mode, based on the orientation of the faces detected, except for images captured with **Continuous**, **BSS**, **Multi-shot 16** (37), or **Subject tracking** (38).
- The orientation of images can be changed using **Rotate image** (71) in the playback menu.

More information

- See "Functions Available in Playback Mode (Playback Menu)" (71) for more information.
- See "Selecting Certain Types of Images for Playback" (70) for more information.

Changing How Images Are Displayed

When using playback mode, you can change how images are displayed by rotating the zoom control to **W** (📐) and **T** (🔍) (📖4).



Playback Zoom

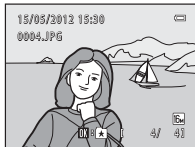

Image is displayed full-frame

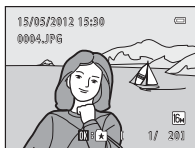

Image is zoomed in

Display area guide

- You can adjust the zoom ratio by rotating the zoom control to **W** (📐)/**T** (🔍). Images can be zoomed up to 10x.
- To view a different area of the image, press the multi selector ▲, ▼, ◀, or ▶.
- If you are viewing an image that was captured using face detection (📖64) or pet detection (📖46), the camera zooms in on the face detected at the time of shooting, except for images captured with **Continuous, BSS, Multi-shot 16** (📖37), or **Subject tracking** (📖38). If the camera detected multiple faces when the image was captured, press ▲, ▼, ◀, or ▶ to display a different face. To zoom in on an area of the image where there are no faces, change the zoom ratio and then, press ▲, ▼, ◀, or ▶.
- You can crop the image and save the displayed area of the image as a separate file by pressing the **MENU** button (📖16).
- Press the **OK** button to return to full-frame playback mode.

Image Thumbnail Display/Calendar Display



Full-frame display



Image thumbnail display (4, 9, and 16 images per screen)







Calendar display

- You can view several images on one screen, making it easy to find the image you want.
- You can change the number of thumbnails displayed by rotating the zoom control to **W** (📐) or **T** (🔍).
- Press the multi selector ▲, ▼, ◀, or ▶ to select an image, and then press the **OK** button to display it full-frame.
- When 16 thumbnails are displayed, rotate the zoom control to **W** (📐) to switch to calendar display (except for list by date mode).
- While using calendar display mode, press the multi selector ▲, ▼, ◀, or ▶ to select a date and then press the **OK** button to display the first image captured on that day.

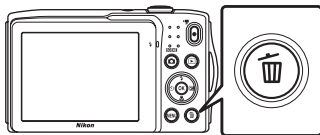
Step 6 Delete Unwanted Images



- 1 Press the  button to delete the image currently displayed in the monitor.



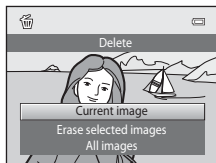

- 2 Press the multi selector  or  to choose the desired deletion method and press the  button.

- **Current image:** Delete the image currently displayed.
- **Erase selected images:** Select multiple images and delete them. See "Operating the Erase Selected Images Screen" (📖33) for more information.
- **All images:** Delete all images.
- To exit without deleting the image, press the **MENU** button.



- 3 Press  or  to choose **Yes** and press the  button.

- Deleted images cannot be recovered.
- To exit without deleting the image, press  or  to select **No** and press the  button.



Notes About Deleting Images

- Once deleted, images cannot be recovered. Transfer important images to a computer or other media before deleting them.
- Protected images cannot be deleted (📖71).

Deleting the Last Image Captured while in Shooting Mode

In shooting mode, press the  button to delete the last image that was saved.

Operating the Erase Selected Images Screen

- 1** Press the multi selector ◀ or ▶ to choose an image to be deleted, and then press ▲ to display ✓.
- To undo the selection, press ▼ to remove ✓.
 - Rotate the zoom control (📖) to **T** (🔍) to switch back to full-frame playback or **W** (📖) to display thumbnails.



- 2** Add ✓ to all images to be deleted and press the (OK) button to apply the selection.
- A confirmation dialog is displayed. Follow the onscreen instructions for more operations.

Selecting Certain Types of Images for Deletion

When using favorite pictures mode, auto sort mode, or list by date mode, you can select images for deletion from an album, category, or shooting date (📖70).



A series of horizontal dashed lines spanning the width of the page, intended for handwriting practice. There are 15 lines in total, starting from the top right and extending to the bottom left.



Shooting Features

This chapter describes each of the camera's shooting modes and the features that are available when using each shooting mode.

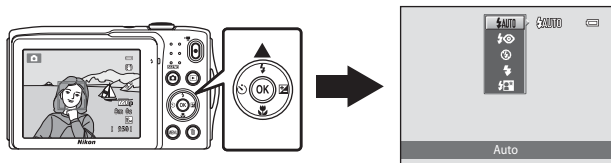
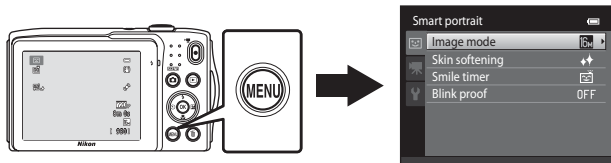
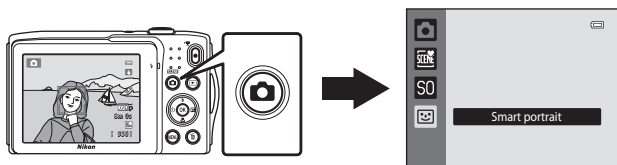

By referring to this information, you will learn how to select different shooting modes and adjust settings according to the shooting conditions and the kind of images you want to take.



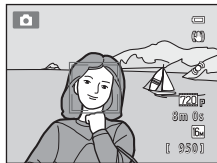

(Auto) Mode





 (auto) mode is useful for general photography, and it allows you to customize a variety of settings to suit the shooting conditions and the type of shot you want to capture (37).



On the shooting screen →  (shooting mode) button →  (auto) mode (24-25)

- You can change how the camera selects the area of the frame to focus on by pressing the **MENU** button, selecting the  tab, and setting **AF area mode**. The default setting is **Face priority**.
- When **AF area mode** in the shooting menu is set to **Face priority** (default setting) the camera focuses on the subject as follows:
 - If the camera detects a human face, the camera automatically focuses on it (see "Face Detection" (64) for more information).
 - If no faces are detected, the camera automatically selects one or more of the nine focus areas containing the subject closest to the camera. When the subject is in focus, the focus area (active focus area) lights in green (maximum of nine areas).

Changing (Auto) Mode Settings

- Features That Can Be Set Using the Multi Selector (52): Flash mode (53), self-timer (55), macro mode (56), and exposure compensation (57).
- Features that can be set by pressing **MENU** button: Shooting Menu Options in  (Auto) Mode (37).



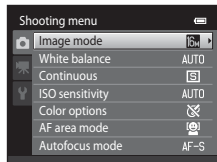

Shooting Menu Options in (Auto) Mode

In (auto) mode, the following options can be changed.



On the (Auto) mode shooting screen → MENU button

Option	Description	
Image mode	Allows you to select the combination of image size and image quality used when saving images. The default setting is 4608×3456 . This setting is applied to other shooting modes.	60
White balance	Allows you to adjust the colors in the image to suit the light source, which can make colors appear as they do to the eye. Although Auto (default setting) can be used under most types of lighting, white balance can be adjusted to suit the sky conditions or light source and achieve more natural color tones in the image. <ul style="list-style-type: none"> Set the flash to (Off) when white balance is set to any setting other than Auto and Flash. 	24
Continuous	Allows you to select from continuous settings of Single , Continuous , BSS (44), or Multi-shot 16 . The default setting is Single (i.e., only one image is captured at a time). In Continuous , while the shutter-release button is held down, up to 6 images are captured at a rate of about 1.3 frames per second (fps) when image mode is set to 4608×3456 .	26
ISO sensitivity	Higher ISO sensitivity allows you to shoot in lower light conditions and thus take pictures of darker subjects. Additionally, even with subjects of similar brightness, pictures can be taken at faster shutter speeds, and blurring caused by camera shake and subject movement can be reduced. When ISO sensitivity is set to Auto (default setting), the camera sets the ISO sensitivity automatically. If Auto is selected and the ISO sensitivity is raised automatically, the is displayed in the shooting screen (6).	28

Option	Description	
Color options	Allows you to change the color tones of images at the time of shooting. The available settings are Standard color (default setting), Vivid color , Black-and-white , Sepia , and Cyanotype .	 29
AF area mode	Allows you to select how the camera determines the focus area for autofocus, from Face priority (default setting), Auto , Manual , Center , or Subject tracking .	 30
Autofocus mode	When Single AF (default setting) is selected, the camera focuses only while the shutter-release button is pressed halfway. When Full-time AF is selected, the camera focuses even when the shutter-release button is not pressed halfway. You may hear the sound of the camera focusing.	 33

 **Functions That Cannot Be Used Simultaneously**

Scene Mode (Shooting Suited to Scenes)

Camera settings are automatically optimized for the selected subject type. Scene modes shown as below are available.

On the shooting screen → (shooting mode) button → (second icon from the top*) → → select a scene (24-25)

* The icon for the last scene mode selected is displayed. The default setting is (Scene auto selector).

Scene auto selector (40)	Portrait (40)	Landscape (40)	Sports (41)
Night portrait (41)	Party/indoor (41)	Beach (41)	Snow (42)
Sunset (42)	Dusk/dawn (42)	Night landscape (42)	Close-up (43)
Food (43)	Museum (44)	Fireworks show (44)	Black and white copy (44)
Backlighting (44)	Panorama assist (45)	Pet portrait (46)	

Displaying a Description of Each Scene Mode (Help Display)

Choose the desired scene type from the scene selection screen and rotate the zoom control (2) to **T** () to view a description of that scene. To return to the original screen, rotate the zoom control to **T** () again.









Changing Scene Mode Settings

- Depending on the scene, the multi selector () , () , () , and () can be used to set the corresponding features. See “Default Settings” (58) for more information.
- Features that can be set using the **MENU** button: Image mode (the combination of image size and image quality) (60).

Scene Mode and Features

Scene auto selector

The camera simplifies shooting by automatically selecting the optimum scene mode as shown below when the shot is framed.

: Portrait, : Landscape, : Night portrait, : Night landscape, : Close-up, : Backlighting, : Other scenes

- When the camera selects a scene mode, the shooting mode icon displayed in the shooting screen changes to that for the scene mode currently enabled.
- The area of the frame that the camera focuses on (AF area) depends on the composition of the picture. When the camera detects a human face, it focuses on that face (□64).
- Depending upon shooting conditions, the camera may not select the desired scene mode. Should this occur, switch to  (auto) mode (□24) or select the desired scene mode manually (□39).
- Digital zoom is not available.

Portrait

Use this mode for portraits.

- The camera detects a human face and focuses on it (□64).
- The camera smoothes skin tones by applying the skin softening function (□66).
- If no faces are detected, the camera focuses on the subject at the center of the frame.
- Digital zoom is not available.





Landscape

Use this mode for vivid landscapes and cityscapes.

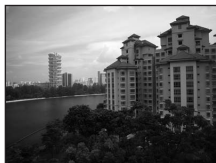
- When the shutter-release button is pressed halfway, focus areas or the focus indicator (□6) always glows green.



: Use of a tripod is recommended in scene modes indicated with . Set **Vibration reduction** to **Off** in the setup menu (□86) when using a tripod to stabilize the camera during shooting.

Sports

Use this mode for dynamic action shots that freeze the action in a single shot and record motion in a series of still images.

- The camera focuses at the center of the frame.
- To take images continuously, hold down the shutter-release button. Up to 6 images are captured at a rate of about 1.3 frames per second (fps) when image mode is set to .

4608x3456



- The camera continuously adjusts focus even when the shutter-release button is not pressed halfway. You may hear the sound of the camera focusing.
- During continuous shooting, focus, exposure, and hue are fixed at the values determined with the first image in each series.
- The frame rate with continuous shooting may vary depending upon the current image mode setting, the memory card used, or shooting condition.



Night portrait



Use this mode for portraits taken at sunset or at night.

- The camera detects a human face and focuses on it (.
- The camera smoothes skin tones by applying the skin softening function (.
- If no faces are detected, the camera focuses on the subject at the center of the frame.
- Digital zoom is not available.



Party/indoor

Captures the effects of candlelight and other indoor background lighting.

- The camera focuses at the center of the frame.
- Hold the camera steadily when shooting in dark surroundings. Set **Vibration reduction** to **Off** in the setup menu () when using a tripod to stabilize the camera during shooting.



Beach

Captures the brightness of such subjects as beaches or sunlit expanses of water.

- The camera focuses at the center of the frame.



Scene Mode (Shooting Suited to Scenes)

Snow

Captures the brightness of sunlit snow.

- The camera focuses at the center of the frame.



Sunset

Preserves the deep hues seen in sunsets and sunrises.

- The camera focuses at the center of the frame.



Dusk/dawn

Preserves the colors seen in the weak natural light before sunrise or after sunset.

- When the shutter-release button is pressed halfway, focus areas or the focus indicator () always glows green.





Night landscape

Slow shutter speeds are used to produce stunning night landscapes.

- When the shutter-release button is pressed halfway, focus areas or the focus indicator () always glows green.



: Use of a tripod is recommended in scene modes indicated with . Set **Vibration reduction** to **Off** in the setup menu () when using a tripod to stabilize the camera during shooting.

Close-up

Photograph flowers, insects and other small objects at close range.

- Macro mode (📖56) is enabled and the camera automatically zooms to the closest position at which it can focus.
- The active focus area can be moved by pressing the **OK** button and then pressing the multi selector **▲**, **▼**, **◀**, or **▶**. Before making any of the settings below, press the **OK** button to cancel the focus-area selection.
 - Flash mode
 - Self-timer
 - Exposure compensation
- The camera continuously adjusts focus even when the shutter-release button is not held down halfway. You may hear the sound of the camera focusing.



Food

Use when taking pictures of food.

- Macro mode (📖56) is enabled and the camera automatically zooms to the closest position at which it can focus.
- You can adjust the hue by pressing the multi selector **▲** and **▼**. The selected hue adjustment setting is saved in the camera's memory even after the camera is turned off.
- The active focus area can be moved by pressing the **OK** button and then pressing the multi selector **▲**, **▼**, **◀**, or **▶**. Before making any of the settings below, press the **OK** button to cancel the focus-area selection.
 - Hue
 - Self-timer
 - Exposure compensation
- The camera continuously adjusts focus even when the shutter-release button is not held down halfway. You may hear the sound of the camera focusing.

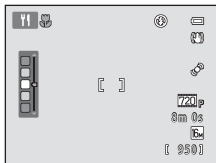

Scene Mode (Shooting Suited to Scenes)

Museum

Use indoors where flash photography is prohibited (for example, in museums and art galleries) or in other settings in which you do not want to use the flash.

- The camera focuses at the center of the frame.
- The camera captures a series of up to ten images while the shutter-release button is held all the way down, and the sharpest image in the series is automatically selected and saved (BSS (Best Shot Selector)).



Fireworks show



Slow shutter speeds are used to capture the expanding burst of light from a firework.

- The camera focuses at infinity.
- The focus indicator (6) always glows green when the shutter-release button is pressed halfway.



Black and white copy

Provides clear images of text or drawings on a whiteboard or in print.

- The camera focuses at the center of the frame.
- Use with macro mode (56) when shooting a subject at close distance.







Backlighting

Use when light is coming from behind the subject, throwing features or details into shadow. The flash fires automatically to “fill in” (illuminate) shadows.





- The camera focuses at the center of the frame.



: Use of a tripod is recommended in scene modes indicated with . Set **Vibration reduction** to **Off** in the setup menu (86) when using a tripod to stabilize the camera during shooting.

 Panorama assist

Takes a series of images that you can join together into a panorama on a computer.

- Select the direction in which to add images to the panorama by pressing the multi selector ▲, ▼, ◀, or ▶ and then press the  button.
- After taking the first image, take the additional shots needed while checking how each image will connect to the next. To finish shooting, press the  button.
- Transfer the images to a computer and use Panorama Maker 6 (74) to join them into a single panorama.
- See "Using Panorama Assist" (2) for more information.



Scene Mode (Shooting Suited to Scenes)

Pet portrait

Use this mode for taking portraits of pets (dogs or cats). When the camera detects the face of a dog or cat, it focuses on the face and automatically releases the shutter (pet portrait auto release).



- On the screen displayed when  **Pet portrait** is selected for scene mode, select **Single** or **Continuous**.

- **Single**: The camera takes one image at a time.
- **Continuous** (default setting): When focus is acquired on the detected face, 3 images can be captured (Continuous shooting speed: about 1.2 fps when the image mode setting is  **4608x3456**).  icon is displayed in the monitor during shooting when **Continuous** is selected.

- A double border (focus area) is displayed around the detected face, and it turns green when the focus is acquired. Up to five faces can be detected. When the camera detects more than one face, the double border is displayed around the largest face, and single borders are displayed around the others.



- When no pet faces are detected, the shutter can be released by pressing the shutter-release button.

- The camera focuses on the subject at the center of the frame when no pet faces are detected.
- When **Continuous** is selected, up to 6 images are captured at a rate of about 1.3 fps while the shutter-release button is held down (when the image mode setting is  **4608x3456**).

- Press the multi selector  to change auto release settings.

- **Pet portrait auto release** (default setting): The camera automatically releases the shutter when it focuses on the detected face. While **Pet portrait auto release** is selected, the  icon is displayed in the shooting screen.

- **OFF**: The shutter is released only when the shutter-release button is pressed.

- Digital zoom is not available.

- Factors such as the distance between the pet and the camera, the orientation or brightness of the face, and the speed at which the pet is moving may prevent the camera from detecting the faces of dogs or cats or may cause the camera to display borders around faces other than those of dogs or cats.



- **Pet portrait auto release** turns off automatically when:

- Five bursts have been taken.
- Internal memory or the memory card is full.

To continue taking pictures with **Pet portrait auto release**, press the multi selector  and change the setting again.

Special Effects Mode (Applying Effects When Shooting)



Effects can be applied to images during shooting.

On the shooting screen →  (shooting mode) button → SO (third icon from the top*) →  → select an effect (📖24-25)

* The icon of the last effect selected is displayed. The default setting is SO (soft).

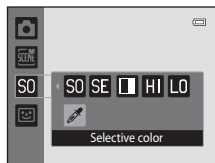
The following six effects are available.



Category	Description
SO Soft (default setting)	Softens the image by adding a slight blur to the entire image.
SE Nostalgic sepia	Adds a sepia tone and reduces the contrast to simulate the qualities of an old photograph.
 High-contrast monochrome	Changes the image to black and white and gives it sharp contrast.
HI High key	Gives the entire image a bright tone.
LO Low key	Gives the entire image a dark tone.
 Selective color	Creates a black and white image in which only the specified color remains.

- The camera focuses on the area at the center of the frame.
- When **Selective color** is selected, press the multi selector ▲ or ▼ to select the desired color from the slider.

To change settings for any of the following functions, first press the  button to cancel color selection, then change the settings as desired.

- Flash mode (📖53)
- Self-timer (📖55)
- Macro mode (📖56)
- Exposure compensation (📖57)

To return to the color selection screen, press the  button again.

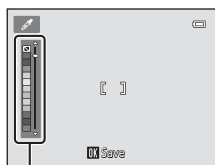

Slider



Changing Special Effects Mode Settings

- Features that can be set using the multi selector (📖52): Flash mode (📖53), self-timer (📖55), macro mode (📖56), and exposure compensation (📖57).
- Features that can be set by pressing the **MENU** button: Image mode, which is the combination of image size and image quality (📖60).

Smart Portrait Mode (Capturing Images of Smiling Faces)

When human smiles are detected, the camera automatically releases the shutter without you having to press the shutter-release button (smile timer). You can also use the skin softening option to smooth the skin tones of human faces.

On the shooting screen → 📷 (shooting mode) button → 🗨️ Smart portrait (📖24-25)

1 Frame a picture and wait for the subject to smile without pressing the shutter-release button.

- When the camera detects a human face, a yellow double border (focus area) is displayed around that face. When the camera has focused on that face, the double border will turn green for a moment and focus is locked.
- Up to three faces can be detected. When the camera detects more than one face, a double border is displayed around the face closest to the center of the frame, and single borders are displayed around the other faces.
- If the camera detects that the face framed by the double border is smiling, **Smile timer** (📖51) is activated and the shutter is automatically released.
- Each time the shutter is released, the camera again initiates face detection and smile detection operations for continuous automatic shooting.

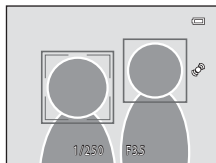

2 Stop shooting.

- To stop automatic shooting of smiling faces, perform the followings.
 - Turn the camera off.
 - Set **Smile timer** (📖51) to **Off**.
 - Press the 📷 button and select other shooting mode.

Notes About Smart Portrait Mode

- Digital zoom is not available.
- Under some shooting conditions, the camera may be unable to detect faces or smiles.
- See "Notes About Face Detection Function" (📖65) for more information.

Auto Off in Smile Timer Mode

When **Smile timer** is set to **On**, the auto off function (📖87) is activated and the camera turns off when either of the situations indicated below persists and no other operations are performed.

- The camera does not detect any faces.
- The camera detected a face, but cannot detect a smile.

Self-timer Lamp

The self-timer lamp flashes when the smile timer is enabled and the camera detects a face, and it flashes quickly immediately after the shutter is released.

Releasing the Shutter Manually

Pictures can also be taken by pressing the shutter-release button. If no faces are detected, the camera focuses on the subject at the center of the frame.

Changing Smart Portrait Mode Settings

- Features That Can Be Set Using the Multi Selector (📖52): Flash mode (📖53), self-timer (📖55), and exposure compensation (📖57).
- See “Smart Portrait Menu Options” (📖51) for more information about functions that can be set using the **MENU** button.

Smart Portrait Menu Options

In smart portrait mode, the following options can be changed.

On the smart portrait mode shooting screen → **MENU** button

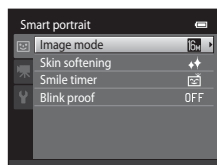

Option	Description	📖
Image mode	Allows you to select the combination of image size and image quality used when saving images. If you change the image mode setting, the new setting is applied to all shooting modes.	60
Skin softening	Allows you to set the skin softening effect. The camera softens facial skin tones by applying the skin softening function before saving images. You can select the amount of effect that is applied. The default setting is Normal .	📖34
Smile timer	When On (default setting) is selected, the camera detects human faces and then automatically releases the shutter whenever a smile is detected. The self-timer cannot be used with this feature.	📖34
Blink proof	When On is selected, the camera automatically releases the shutter twice each time a picture is taken. Of the two shots, one in which the subject's eyes are open is saved. Flash cannot be used when On is selected. The default setting is Off .	📖35

📌 Functions That Cannot Be Used Simultaneously

There are functions with which this setting cannot be enabled. See “Functions That Cannot Be Applied Simultaneously” (📖62) for more information.

Features That Can Be Set Using the Multi Selector

The following shooting functions can be set by pressing the multi selector ▲ (⚡), ▼ (📷), ◀ (🕒), or ▶ (📷) when shooting.

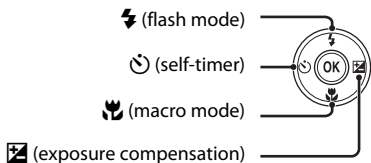

Functions Available for Each Shooting Mode

The functions that can be set vary depending on the shooting mode, as shown below.

- See “Default Settings” (📖58) for information about each mode’s default settings.

Functions	📷 (Auto mode)	Scene	Special effects	Smart portrait
Flash mode (📖53)	✓	1	✓	✓ ²
Self-timer (📖55)	✓		✓	✓ ²
Macro (📖56)	✓		✓	–
Exposure compensation (📖57)	✓		✓	✓

¹ Varies by the scene. See “Default Settings” (📖58) for more information.

² Varies by the smart portrait menu setting. See “Default Settings” (📖58) for more information.

Using the Flash (Flash Modes)

The flash mode can be set to match the shooting conditions.

- 1** Press the multi selector ▲ (⚡ flash mode).



- 2** Press the multi selector ▲ or ▼ to choose the desired flash mode and press the OK button.

- See “Available Flash Modes” (📖54) for more information.
- If a setting is not applied by pressing the OK button within a few seconds, the selection will be canceled.
- When ⚡AUTO (Auto) is applied, ~~⚡~~AUTO is only displayed for a few seconds, regardless of **Photo info** settings (🔍53).

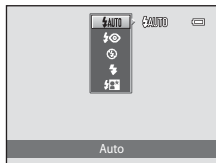

- 3** Frame the subject and take a picture.

- The flash lamp indicates flash status when the shutter-release button is pressed halfway.
 - On: The flash will fire when you press the shutter-release button all the way down.
 - Flashes: The flash is charging. Wait a few seconds and try again.
 - Off: The flash will not fire when a picture is taken.
- If the battery is low, the monitor will be turned off while the flash is charging.

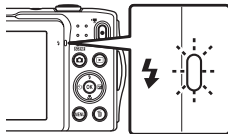

Effective Range of the Flash

When ISO sensitivity is set to **Auto**, the flash has a range of 0.5–4.5 m (1 ft 8 in.–14 ft) at the maximum wide-angle zoom position and a range of 0.5–2.4 m (1 ft 8 in.–7 ft 10 in.) at the maximum telephoto zoom position.

Available Flash Modes



Auto

Flash fires automatically when lighting is dim.



Auto with red-eye reduction

Suited to pictures of people. This option reduces the “red-eye” phenomenon that caused by the use of flash.



Off

Flash will not fire even when lighting is dim.
We recommend using a tripod to stabilize the camera when shooting in dim lighting.



Fill flash

Flash fires whenever a picture is taken. Use to “fill-in” (illuminate) shadows and backlit subjects.



Slow sync

Auto flash mode is combined with slow shutter speed.
Suited to evening and night portraits that include background scenery.
Flash illuminates main subject; slow shutter speeds are used to capture background at night or under dim lighting.



The Flash Mode Setting

- The default flash mode setting varies with shooting mode. See “Default Settings” (📖58) and “Functions Available for Each Shooting Mode” (📖52) for more information.
- Some flash settings cannot be used with other functions. See “Functions That Cannot Be Applied Simultaneously” (📖62) for more information.
- The flash mode setting applied in 📷 (auto) mode is stored in the camera’s memory even after the camera is turned off.



Red-eye Reduction

This camera uses advanced red-eye reduction (“In-Camera Red-Eye Fix”).

If the camera detects “red eye” while saving an image, the affected area will be processed to reduce red-eye before the image is saved.

Note the following when shooting:

- More time than usual is required to save images.
- Red-eye reduction may not produce the desired results in some situations.
- In extremely rare instances, areas not subject to red-eye may be affected by red-eye reduction processing; in these cases, choose another flash mode and try again.

Using the Self-timer

The camera is equipped with a self-timer that releases the shutter ten seconds or two seconds after you press the shutter-release button. The self-timer is useful when you want to be in the picture you are taking, and when you want to avoid the effects of camera shake that occur when you press the shutter-release button. When using the self-timer, use of a tripod is recommended. Set **Vibration reduction** to **Off** in the setup menu (📖86) when using a tripod to stabilize the camera during shooting.

1 Press the multi selector ◀ (🕒 self-timer).



2 Press the multi selector ▲ or ▼ to choose 🕒10s or 🕒2s and press the OK button.

- 🕒10s (ten seconds): Use on important occasions, such as weddings
- 🕒2s (two seconds): Use to prevent camera shake
- If a setting is not applied by pressing the OK button within a few seconds, the selection will be canceled.
- When the shooting mode is set to **Pet portrait** scene mode, 🐾 (Pet portrait auto release) is displayed (📖46). The self-timer settings 🕒10s and 🕒2s cannot be used.

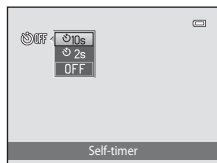

3 Frame the picture and press the shutter-release button halfway.

- Focus and exposure will be set.

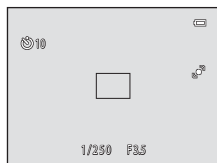

4 Press the shutter-release button the rest of the way down.

- The self-timer starts, and the number of seconds remaining before the shutter is released is displayed in the monitor. The self-timer lamp flashes while the timer is counting down. About one second before the shutter is released, the lamp stops flashing and glows steadily.
- When the shutter is released, the self-timer will be set to **OFF**.
- To stop the timer before a picture is taken, press the shutter-release button again.

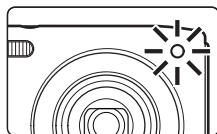
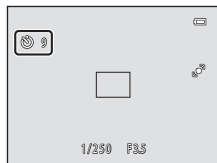

Using Macro Mode

When using macro mode, the camera can focus on objects as close as approximately 5 cm (2 in.) from the front of the lens. This feature is useful when taking close-up pictures of flowers and other small subjects.

- 1 Press the multi selector ▼ (🔍 macro mode).



- 2 Press the multi selector ▲ or ▼ to choose **ON** and press the **OK** button.

- The macro mode icon (🔍) is displayed.
- If the setting is not applied by pressing the **OK** button within a few seconds, the selection will be canceled.

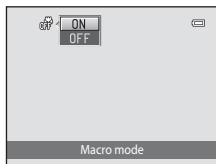

- 3 Rotate the zoom control to set the zoom ratio to a position where 🍷 and the zoom indicator glow green.



- How close you can be to the subject when shooting depends on the zoom ratio. When the zoom ratio is set to a position where 🍷 and the zoom indicator glow green, the camera can focus on subjects as close as approximately 10 cm (4 in.) from the lens. When the zoom is at the maximum wide-angle position, (at the position where ▲ is displayed), the camera can focus on subjects as close as approximately 5 cm (2 in.) from the lens.

✔ Note About Using the Flash

The flash may be unable to light the entire subject at distances of less than 50 cm (1 ft 8 in.).

📎 Note About Autofocus

When using macro mode in the 📷 (auto) mode, you can focus without pressing the shutter-release button halfway by setting **Autofocus mode** (📖38) in the shooting menu (📖37) to **Full-time AF**. When using other shooting modes, **Full-time AF** is turned on automatically when macro mode is turned on. You may hear the sound of the camera focusing.

📎 The Macro Mode Setting

- Macro mode cannot be used when using certain shooting modes. See “Features That Can Be Set Using the Multi Selector” (📖52) for more information.
- The macro mode setting applied in 📷 (auto) mode is stored in the camera’s memory even after the camera is turned off.

Adjusting Brightness (Exposure Compensation)

Exposure compensation is used to alter exposure from the value suggested by the camera to make images brighter or darker.

- 1 Press the multi selector ► (with exposure compensation icon).



- 2 Press the multi selector ▲ or ▼ to select a compensation value.

- To make the image brighter, apply positive (+) exposure compensation.
- To make the image darker, apply negative (-) exposure compensation.

Exposure compensation guide

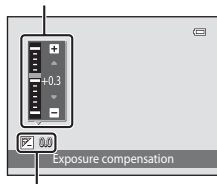

Exposure compensation value

- 3 Press the **OK** button to apply the compensation value.

- If you do not press the **OK** button within a few seconds, the menu will disappear.
- When an exposure compensation value other than **0.0** is applied, the value is displayed with the  indicator in the monitor.

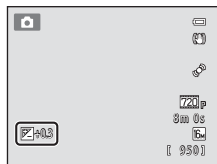

- 4 Press the shutter-release button to take a picture.

- To exit without altering exposure, return to step 1, change the value to **0.0** and press the **OK** button.









Exposure Compensation Value

The exposure compensation value applied in  (auto) mode is stored in the camera's memory even after the camera is turned off.

Default Settings

The default settings for each function in each shooting mode are described below.

- See the next page for information about the default settings in the scene modes.

	Flash ( 53)	Self-timer ( 55)	Macro ( 56)	Exposure compensation ( 57)
 (Auto mode)	 AUTO	Off	Off	0.0
SO (Special effects)		Off	Off	0.0
 (Smart portrait)	 AUTO ¹	Off ²	Off ³	0.0































































¹ Cannot be used when **Blink proof** is set to **On**.



² Can be set when **Smile timer** is set to **Off**.

³ The setting cannot be changed.

The setting applied in  (auto) mode is saved in the camera's memory even after the camera is turned off (except the self-timer setting).

The default settings for each function in scene mode are described below.

	Flash ( 53)	Self-timer ( 55)	Macro ( 56)	Exposure compensation ( 57)
 ( 40)	 AUTO ¹	Off	Off ²	0.0
 ( 40)		Off	Off ²	0.0
 ( 40)	 ²	Off	Off ²	0.0
 ( 41)	 ²	Off ²	Off ²	0.0
 ( 41)	 ³	Off	Off ²	0.0
 ( 41)	 ⁴	Off	Off ²	0.0
 ( 41)	 AUTO	Off	Off ²	0.0
 ( 42)	 AUTO	Off	Off ²	0.0
 ( 42)	 ²	Off	Off ²	0.0
 ( 42)	 ²	Off	Off ²	0.0
 ( 42)	 ²	Off	Off ²	0.0
 ( 43)		Off	On ²	0.0
 ( 43)	 ²	Off	On ²	0.0
 ( 44)	 ²	Off	Off	0.0
 ( 44)	 ²	Off ²	Off ²	0.0 ²
 ( 44)		Off	Off	0.0
 ( 44)	 ²	Off	Off ²	0.0
 ( 45)		Off	Off	0.0
 ( 46)	 ²	 ⁵	Off	0.0

¹ AUTO (**Auto**) or  (**Off**) can be selected. When AUTO (**Auto**) is selected, the camera automatically selects the flash mode appropriate for the scene it has been selected.

² Cannot be modified.

³ Cannot be modified. Fixed to the fill flash with slow sync and red-eye reduction.

⁴ Slow sync with red-eye reduction flash mode may be used.

⁵ Self-timer is disabled. **Pet portrait auto release** (46) can be turned on or off.

Functions That Cannot Be Used Simultaneously

There are functions with which these settings cannot be enabled (62).

Changing the Image Size (Image Mode)

On the shooting screen → MENU button → Image mode

You can use the **image mode** setting in the shooting menu to select the combination of image size and compression ratio that is used when saving images.

Choose the image mode best suited to the manner in which images will be used and the capacity of the internal memory or memory card. The higher the image mode setting, the larger the size at which it can be printed, but limiting the number of images that can be recorded.

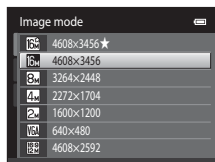

Image Mode Settings (Image Size and Quality)

Image mode*	Description
4608×3456★	Higher quality than , suitable for enlargements or high-quality prints. The compression ratio is approximately 1:4.
4608×3456 (default setting)	Best choice in most situations. The compression ratio is approximately 1:8.
3264×2448	
2272×1704	
1600×1200	Smaller size than , , or allows more images to be stored. The compression ratio is approximately 1:8.
640×480	Suited to full-screen display on a television with an aspect ratio of 4:3, or distribution by e-mail. The compression ratio is approximately 1:8.
4608×2592	Images with an aspect ratio of 16:9 are recorded. The compression ratio is approximately 1:8.

* The total number of pixels recorded, and the number of pixels recorded horizontally and vertically.

Example: **4608×3456** = Approx. 16 megapixels, 4608 × 3456 pixels







The icon for the current setting is displayed in the monitor in shooting and playback modes (6, 7).

Image Mode

- Change made to this setting applies to all shooting modes.
- There are functions with which this setting cannot be enabled. See “Functions That Cannot Be Applied Simultaneously” (162) for more information.

Number of Exposures Remaining

The following table lists the approximate number of images that can be stored in internal memory and on a 4 GB memory card. Note that the number of images that can be stored will differ depending on the composition of the image (due to JPEG compression). In addition, this number may vary depending on the make of memory card, even when the memory cards have the same specified capacity.

Image mode	Internal memory (approx. 42 MB)	Memory card ¹ (4 GB)	Print size ² (cm/in.)
 4608×3456 ★	3	490	Approx. 39 × 29/15 × 11.5
 4608×3456	7	950	Approx. 39 × 29/15 × 11.5
 3264×2448	15	1890	Approx. 28 × 21/11 × 8
 2272×1704	33	3750	Approx. 19 × 14/7.5 × 5.6
 1600×1200	74	7660	Approx. 13 × 10/5.3 × 4
 640×480	239	24000	Approx. 5 × 4/2 × 1.5
 4608×2592	10	1190	Approx. 39 × 22/15 × 8.5



¹ If the number of exposures remaining is 10,000 or more, the number of exposures remaining display shows “9999”.

² Print size at an output resolution of 300 dpi. Print sizes are calculated by dividing the number of pixels by printer resolution (dpi) and multiplying by 2.54 cm (1 in.). However, at the same image size, images printed at higher resolutions will print smaller than the size indicated, and those printed at lower resolutions will print larger than the size indicated.

Functions That Cannot Be Applied Simultaneously

Some shooting settings cannot be used with other functions.

Restricted function	Setting	Description
Flash mode	Continuous (37)	When Continuous , BSS , or Multi-shot 16 is selected, flash is disabled.
Self-timer	AF area mode (38)	When Subject tracking is selected, self-timer is disabled.
Macro mode	AF area mode (38)	When Subject tracking is selected, macro mode is disabled.
Image mode	Continuous (37)	When Multi-shot 16 is selected, the Image mode setting is fixed at S (image size: 2560 × 1920 pixels).
	ISO sensitivity (37)	When 3200 is selected, the image mode setting of only L 2272×1704 , M 1600×1200 , or P 640×480 can be selected. If any image mode setting other than above is selected, the image mode setting is automatically changed to L 2272×1704 when ISO sensitivity is set to 3200 .
White balance	Color options (38)	When Black-and-white , Sepia , or Cyanotype is selected, the White balance setting is fixed at Auto .
Continuous	Self-timer (55)	When using the self-timer, the continuous setting is fixed to Single .
ISO sensitivity	Continuous (37)	When Multi-shot 16 is selected, the ISO sensitivity setting is automatically specified according to the brightness.
AF area mode	Digital zoom (87)	When the digital zoom is in effect, focus area is fixed at Center .
Motion detection	AF area mode (38)	When taking a picture using Subject tracking , Motion detection is disabled.
	Continuous (37)	When Multi-shot 16 is selected, Motion detection is not enabled.
	ISO sensitivity (37)	When a setting other than Auto is selected, Motion detection is disabled.

Restricted function	Setting	Description
Blink warning	Continuous ( 37)	When Continuous , BSS , or Multi-shot 16 is selected, Blink warning is disabled.
Digital zoom	Continuous ( 37)	When Multi-shot 16 is selected, digital zoom is not available.
	AF area mode ( 38)	When Subject tracking is selected, digital zoom is disabled.

 **Notes About Digital Zoom**

- Digital zoom cannot be used with some settings and shooting modes (58).
- When digital zoom is in effect, the camera focuses at the center of the frame.

Face Detection

When the camera is pointed at a human face in the shooting modes as shown below, the camera automatically detects the face and focuses on it. When the camera detects more than one face, the double border (focus area) is displayed around the face that is focused on, and single borders around the others.

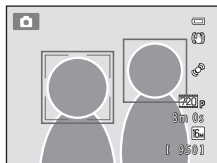

Shooting mode	Number of faces that can be detected	Focus area (double border)
When AF area mode (📖38) is set to Face priority (🔍30) in 📷 (auto) mode (📖36)	Up to 12	The face closest to the camera
Scene auto selector , Portrait (📖40), or Night portrait (📖41) in scene mode (📖39)		
Smart portrait mode (📖49)	Up to 3	The face closest to the center of the frame

- When using 📷 (auto) mode, if you press the shutter-release button halfway while no faces are detected or while framing a shot with no faces in it, the camera selects the focus area (up to nine areas) containing the subject closest to the camera.
- When **Scene auto selector** is selected, the focus area changes depending on which scene the camera selects.
- If no faces are detected when the shutter-release button is pressed halfway in **Portrait** or **Night portrait** scene mode or smart portrait mode, the camera will focus on the subject at the center of the frame.

✓ Notes About Face Detection Function

- The camera's ability to detect faces depends on a variety of factors, including the direction in which the faces are looking. The camera may be unable to detect faces in the following situations:
 - When faces are partially hidden by sunglasses or otherwise obstructed
 - When faces take up too much or too little of the frame
- When the frame includes more than one face, the faces detected by the camera and the face on which the camera focuses depend upon a variety of factors, including the direction in which the faces are looking.
- In some rare cases, the subject may not be in focus despite the fact that the double border glows green (📖29). Should this occur, switch to 📷 (auto) mode and set **AF area mode** to **Manual** or **Center**. Try refocusing on another subject positioned at the same distance from the camera as the actual portrait subject (📖67).

✓ Viewing Images That Were Captured Using Face Detection

- When images in which a face was detected during shooting are played back, the images will be automatically rotated for playback display according to the orientation of the face detected, except images captured using **Continuous, BSS, Multi-shot 16** (📖37, 📷26), or **Subject tracking** (📖38, 📷31).
- In full-frame playback mode, the image is enlarged with the detected face (📖31) at the center of the monitor when the zoom control is rotated to **T** (📷), except images that were captured using **Continuous, BSS, Multi-shot 16** (📖37, 📷26), or **Subject tracking** (📖38, 📷31).

Skin Softening

In the shooting modes as shown below, the camera detects up to three human faces when the shutter is released, and processes the image to soften facial skin tones before saving the image.

- **Scene auto selector, Portrait** (📖40) or **Night portrait** (📖41) scene mode
- Smart portrait mode

Editing functions such as **Skin softening** can be applied to saved images by using **Glamour retouch** (📖71).

✓ Notes About the Skin Softening Function

- More time than usual may be required to save an image when shooting with skin softening function.
- In some shooting conditions, facial skin tones may not be smoothed or parts other than faces may be modified. If the desired results are not produced, switch the camera to other shooting mode or set **Skin softening** to **Off** in smart portrait mode, and shoot again.
- The skin softening level cannot be adjusted when the **Scene auto selector, Portrait** or **Night portrait** is selected in the scene mode.

Focus Lock

Use focus lock to focus on off-center subjects when center is selected for AF area mode. To focus on off-center subjects when **Center** is selected for **AF area mode** in the shooting menu (📖37) in 📷 (auto) mode, use focus lock as described below.

- 1** Position the subject at the center of the frame.

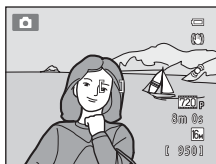

- 2** Press the shutter-release button halfway.

- The camera focuses on the subject and the focus area glows green.
- Focus and exposure are locked.



- 3** Continue holding down the shutter-release button halfway and recompose the picture.

- Be sure that the distance between the camera and the subject does not change.

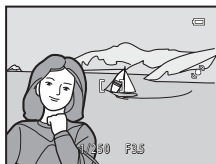

- 4** Press the shutter-release button the rest of the way down to take the picture.





A series of horizontal dashed lines spanning the width of the page, intended for handwriting practice. There are 15 lines in total, starting from the top right and extending to the bottom left.

Playback Features



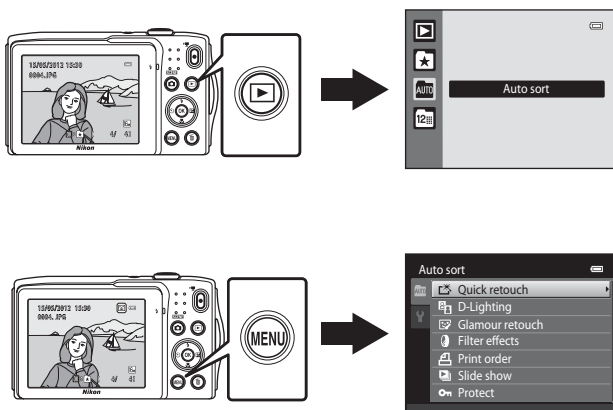

This chapter describes how to select certain types of images for playback as well as some of the features available when playing back images.



Selecting Certain Types of Images for Playback

You can change the playback mode according to the type of images you want to view.

Available Playback Modes



	Play 📖30
All images are played back. When you switch from shooting mode to playback mode, this mode is selected.	
	Favorite pictures 👁️4
Only images added to albums are played back. Images should be added to albums before selecting this mode (📖5).	
	Auto sort 👁️7
Images are automatically sorted into categories, such as portraits, landscapes, and movies. You can play back images in a specific category only.	
	List by date 👁️9
Only images captured on the same date are played back.	

Switching Between Playback Modes

1 Press the  button in full-frame or thumbnail playback mode.

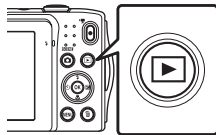
- The screen used to select a playback mode (the playback mode selection menu) is displayed.







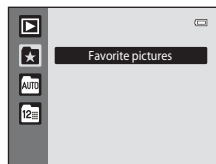

2 Use the multi selector  or  to select a playback mode and press the  button.

- If you select **Play**, the playback screen is displayed.
- When an option other than **Play** is selected, the album, category or shooting date selection screen is displayed.
- To return to the current playback mode without switching playback modes, press the  button.



3 Select an album, a category or a shooting date and press the  button.



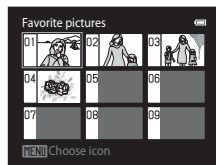



















- For  Favorite Pictures Mode, see 4.
- For  Auto Sort Mode, see 7.
- For  List by Date Mode, see 9.
- Repeat the procedure from step 1 to select an album, category or shooting date again.







Favorite pictures mode

Functions Available in Playback Mode (Playback Menu)

When viewing images in full-frame playback mode or thumbnail playback mode, you can configure the menu operations listed below by pressing the **MENU** button. When using favorite pictures (★), auto sort (Auto), or list by date (12) mode, the menu for the current playback mode is displayed.

Option	Description	
 Quick retouch ¹	Easily create retouched copies in which contrast and saturation have been enhanced.	 12
 D-Lighting ¹	Enhances brightness and contrast in dark portions of images.	 12
 Glamour retouch ¹	Make facial skin tone softer and make faces look smaller with larger eyes.	 13
 Filter effects ¹	Apply a variety of effects using digital filter. The available effects are Soft , Selective color , Cross screen , Fisheye , Miniature effect , and Painting .	 14
 Print order ²	When using a printer to print images saved on the memory card, you can use the Print order function to select which images are printed, and how many copies of each image are printed.	 36
 Slide show ²	View images stored in the internal memory or on a memory card in an automatic slide show.	 40
 Protect ²	Protect selected images from accidental deletion.	 41
 Rotate image	Specifies the orientation in which saved images are displayed during playback.	 43
 Small picture ¹	Create a small copy of the current image. This feature is useful for creating copies for display on Web pages or e-mail attachments.	 15
 Voice memo	Record voice memos using the camera's built-in microphone and attach them to images. Voice memo can also be played back and deleted.	 44
 Copy ³	Copy files between memory card and internal memory.	 46

¹ The selected image is edited, and the copy is saved with a different file name. Images captured at an image mode setting of  **4608×2592** (10) or movies cannot be edited. Once an image has been edited, some editing functions may become unavailable (11).

² When using list by date mode, press the **MENU** button from the list of dates screen (9) to apply the same function to all images captured on the selected date.

³ This function is not available when using favorite pictures mode, auto sort mode, or list by date mode.

Connecting the Camera to a Television, Computer, or Printer

You can enhance your enjoyment of images and movies by connecting the camera to a TV, computer, or printer.

- Before connecting the camera to an external device, make sure the remaining battery level is sufficient and the camera is turned off. For information about the connection methods and subsequent operations, refer to the documentation included with the device in addition to this document.

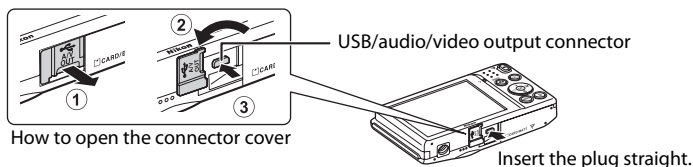

Viewing images on a TV

17

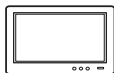

Images and movies captured with the camera can be viewed on a TV. Connection method: Connect the video and audio plugs of the included Audio Video Cable EG-CP14 to the TV's input jacks.

Viewing and organizing images on a computer

73



If you transfer images to a computer, you can perform simple retouching and manage image data in addition to playing back images and movies.

Connection method: Connect the camera to the computer's USB port with the included USB Cable UC-E6.

- Before connecting to a computer, install ViewNX 2 on the computer using the included ViewNX 2 Installer CD-ROM. For information about using the ViewNX 2 Installer CD-ROM and transferring images to a computer, see page 75.
- If any USB devices that draw the power from the computer are connected, disconnect them from the computer before you connect the camera to it. Connecting the camera and other USB-powered devices to the same computer simultaneously may cause a camera malfunction or excessive power supply from the computer, which could damage the camera or memory card.

Printing images without using a computer

18



If you connect the camera to a PictBridge-compatible printer, you can print images without using a computer.

Connection method: Connect the camera directly to the printer's USB port with the included USB Cable UC-E6.

Using ViewNX 2

ViewNX 2 is an all-in-one software package which enables you to transfer, view, edit and share images.

Install ViewNX 2 using the included ViewNX 2 Installer CD-ROM.



Installing ViewNX 2

- An Internet connection is required.

Compatible Operating Systems

Windows

- Windows 7 Home Basic/Home Premium/Professional/Enterprise/Ultimate (Service Pack 1)
- Windows Vista Home Basic/Home Premium/Business/Enterprise/Ultimate (Service Pack 2)
- Windows XP Home Edition/Professional (Service Pack 3)

Macintosh

- Mac OS X (version 10.5.8, 10.6.8, 10.7.2)

Refer to the Nikon website for the latest information on operating system compatibility.

1 Start the computer and insert the ViewNX 2 Installer CD-ROM into the CD-ROM drive.

- Mac OS: When the **ViewNX 2** window is displayed, double-click the **Welcome** icon.

2 Select a language in the language selection dialog to open the installation window.

- If the desired language is not available, click **Region Selection** to choose a different region and then choose the desired language (the **Region Selection** button is not available in the European release).
- Click **Next** to display the installation window.

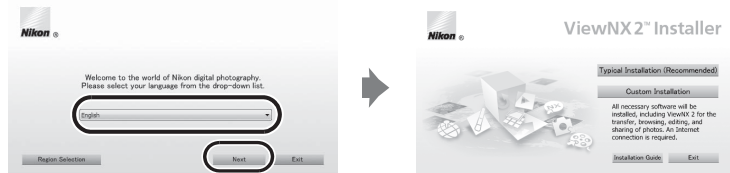

3 Start the installer.

- We recommend clicking **Installation Guide** in the installation window to check the installation help information and system requirements before installing ViewNX 2.
- Click **Typical Installation (Recommended)** in the installation window.

4 Download the software.

- When the **Software Download** screen is displayed, click **I agree - Begin download**.
- Follow the on-screen instructions to install the software.

5 Exit the installer when the installation completion screen is displayed.

- Windows: Click **Yes**.
- Mac OS: Click **OK**.

The following software is installed:

- ViewNX 2 (consisting of the three modules below)
 - Nikon Transfer 2: For transferring images to the computer
 - ViewNX 2: For viewing, editing, and printing transferred images
 - Nikon Movie Editor: For basic editing of transferred movies
- Panorama Maker 6 (for creating a single panorama photo using a series of images shot in panorama assist scene mode)
- QuickTime (Windows only)

6 Remove the ViewNX 2 Installer CD-ROM from the CD-ROM drive.

Transferring Images to the Computer

1 Choose how images will be copied to the computer.

Choose one of the following methods:

- **Direct USB connection:** Turn the camera off and ensure that the memory card is inserted in the camera. Connect the camera to the computer using the supplied USB Cable UC-E6. The camera automatically turns on. To transfer images that are saved in the camera's internal memory, remove the memory card from the camera before connecting it to the computer.

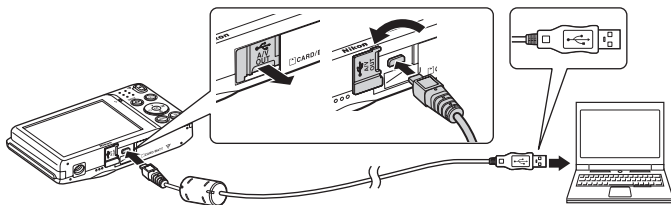

- **SD card slot:** If your computer is equipped with an SD card slot, the card can be inserted directly in the slot.
- **SD card reader:** Connect a card reader (available separately from third-party suppliers) to the computer and insert the memory card.

If a message is displayed prompting you to choose a program, select Nikon Transfer 2.

• When using Windows 7

If the dialog shown at right is displayed, follow the steps below to select Nikon Transfer 2.

- 1 Under **Import pictures and videos**, click **Change program**. A program selection dialog will be displayed; select **Import File using Nikon Transfer 2** and click **OK**.
- 2 Double-click **Import File**.

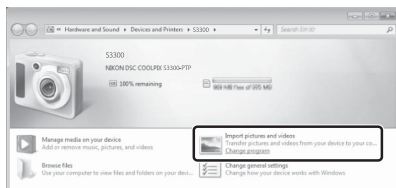

If the memory card contains a large number of images, it may take a while for Nikon Transfer 2 to start. Wait until Nikon Transfer 2 starts.

✓ Connecting the USB Cable

The connection may not be recognized if the camera is connected to the computer via a USB hub.

2 Transfer images to the computer.

- Confirm that the name of the connected camera or removable disk is displayed as the “Source” on the “Options” title bar of Nikon Transfer 2 (①).
- Click **Start Transfer** (②).

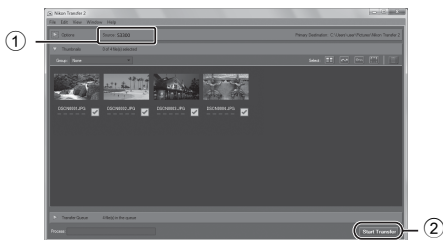

- At default settings, all the images on the memory card will be copied to the computer.

3 Terminate the connection.

- If the camera is connected to the computer, turn the camera off and disconnect the USB cable. If you are using a card reader or card slot, choose the appropriate option in the computer operating system to eject the removable disk corresponding to the memory card and then remove the card from the card reader or card slot.

Viewing Images

Start ViewNX 2.

- Images are displayed in ViewNX 2 when transfer is complete.
- Consult online help for more information on using ViewNX 2.

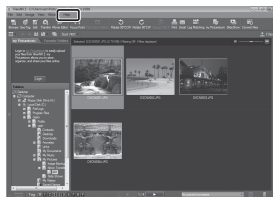

Starting ViewNX 2 Manually

- **Windows:** Double-click the **ViewNX 2** shortcut on the desktop.
- **Mac OS:** Click the **ViewNX 2** icon in the Dock.

Recording and Playing Back Movies

You can record movies by simply pressing the  (movie-record) button.

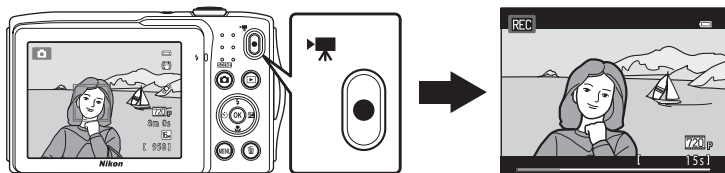

In playback mode, press the  button to play a movie.

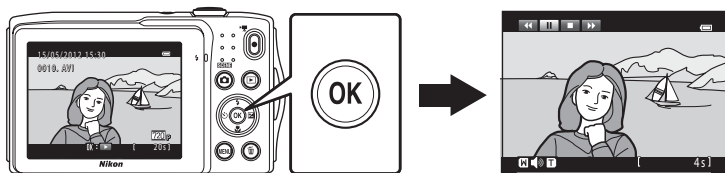

Recording Movies

You can record movies by simply pressing the **●** (▶ movie-record) button. The settings made for still images, such as hue and white balance, are applied when recording movies.

- The maximum file size for a single movie is 2 GB or the maximum movie length for a single movie is 29 minutes, even when there is sufficient free space on the memory card for longer recording (80).
- When no memory card is inserted (when recording in the internal memory), **Movie options** (47) is set to **VGA (640×480)** by default. **720p HD 720p (1280×720)** cannot be selected.

1 Turn on the camera and be sure that it is in shooting mode.

- The icon for the selected movie option is displayed. The default setting is **720p HD 720p (1280×720)** (81).

* Maximum movie length shown in the illustrations may differ from the actual display.

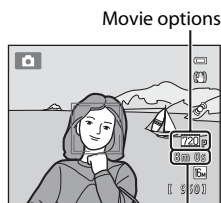

Maximum movie length*

2 Press the **●** (▶ movie-record) button to start movie recording.

- The camera focuses at the center of the frame. Focus areas are not displayed during recording.
- When **720p HD 720p (1280×720)** is selected for **Movie options**, monitor display changes to an aspect ratio of 16:9 with movie recording (the area indicated on the right is recorded).
- When the **Photo info** option in **Monitor settings** (86) in the setup menu is set to **Movie frame+auto info**, a frame indicating the area captured in the recorded movie can be displayed before recording starts.

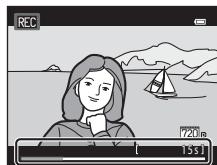
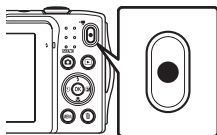

- The approximate remaining movie recording time is displayed during recording. **IN** is displayed when saving movies to the camera's internal memory.
- Recording stops automatically when the maximum movie recording time has elapsed.

3 Press the **●** (▶ movie-record) button again to end recording.

✔ Note on Recording Images and Saving Movies

The indicator showing the number of exposures remaining or the indicator showing the maximum movie length flashes while images are being recorded or while a movie is being saved. **Do not open the battery-chamber/memory card slot cover or remove the battery or memory card** while an indicator is flashing. Doing this could result in loss of data, or in damage to the camera or the memory card.

✔ Recording Movies

- Memory cards with an SD Speed Class rating of 6 or faster are recommended when recording movies (📖19). Movie recording may stop unexpectedly when memory cards with a lower Speed Class ratings are used.
- When recording movies with **720p HD 720p (1280x720)** selected for **Movie options**, the angle of view (the area captured in the recorded movie) is smaller than when taking still pictures.
- Optical zoom cannot be adjusted once movie recording begins.
- Rotate the zoom control during recording to enable digital zoom. Subjects can be magnified up to 4x the optical zoom ratio applied before movie recording began.
- There is some degradation in image quality when digital zoom is used. When recording ends, digital zoom turns off.
- The sounds of zoom control operation, autofocus lens drive movement, vibration reduction, and aperture operation when brightness changes may be recorded.
- Smear (🌀3) visible in the monitor with movie recording will be recorded with movies. Avoiding bright objects such as the sun, reflections of the sun, and electric lights when recording movies is recommended.
- When recording or playing back movies, colored stripes (interference patterns or moiré) may appear on subjects that have a regular, repeating grid, such as pattern of weave in cloths or windows in a building, depending on the shooting distance or zoom ratio. This phenomenon occurs when the subject's pattern interferes with the camera sensor grid, and it does not indicate a malfunction.

✔ Note About Autofocus for Movie Recording

When shooting a subject that is not suitable for autofocus (📖29), the camera may not be able to focus properly on the subject. Follow the procedure below if you are trying to shoot this type of subject for movies.

1. Set **Autofocus mode** in the movie menu to **AF-S Single AF** (default setting) before starting movie recording.
2. Frame a different subject (positioned at the same distance from the camera as the intended subject) at the center of the frame, press the **● (📹 movie-record)** button to start recording, and modify the composition.

✓ Notes About Camera Temperature

- The camera temperature may increase significantly when used for an extended period of time for movie recording, etc. or when used in places with high ambient temperature.
- If the camera becomes extremely hot while recording a movie, the camera automatically terminates recording after 30 seconds. The camera monitor displays the number of seconds (30s) remaining until automatic termination is activated. Five seconds after movie recording is terminated, the camera turns off. Wait until the internal temperature decreases before using it again.

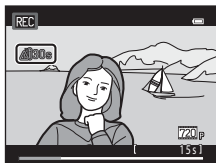

✍ Movie Options and Maximum Recording Time

Movie options (☞81)	Internal memory (approx. 42 MB)	Memory card (4 GB) ²
720p HD 720p (1280×720)	_ ¹	15 min
VGA VGA (640×480)	20 s	45 min
QVGA QVGA (320×240)	1 min 13 s	2 h 45 min

All figures are approximate. The maximum recording time may vary depending on the make of memory card.

- ¹ **720p HD 720p (1280×720)** cannot be selected when saving movies to the camera's internal memory.
- ² The maximum file size for a single movie is 2 GB or the maximum recording time for a single movie is 29 minutes, even when there is sufficient free space on the memory card for longer recording. The maximum recording time that can be recorded for a single movie is displayed during recording.

✍ Functions Available with Movie Recording





- The exposure compensation, white balance, and color options settings for the current shooting mode are also applied with movie recording. The tone that results from using scene mode (☞39) or special effects mode (☞47) is also applied to movies. When macro mode is enabled, movies of subjects closer to the camera can be recorded. Confirm settings before starting movie recording.
- The self-timer (☞55) can be used. When the **●** (movie-record) button is pressed after the self-timer is enabled, the camera starts movie recording after the specified two or ten seconds.
- The flash will not fire.
- Press the **MENU** button to select the **🎬** (movie) tab and adjust movie menu settings before starting movie recording (☞81).

Changing Movie Recording Settings (The Movie Menu)

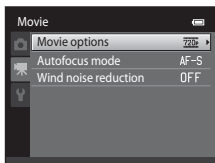
On the shooting screen → MENU button →  tab (📖10)

The following options can be adjusted.





Option	Description	
Movie options	<p>The following movie types are available: 720p HD 720p (1280×720) (default setting), VGA VGA (640×480), and QVGA QVGA (320×240). Movies with an aspect ratio of 16:9 can be recorded by selecting 720p HD 720p (1280×720).</p> <ul style="list-style-type: none"> When recording in the internal memory, the default setting is VGA VGA (640×480). 	 47
Autofocus mode	<p>Select between AF-S Single AF (default setting), which locks focus when movie recording starts, and AF-F Full-time AF which focuses continuously during movie recording. When AF-F Full-time AF is selected, the sound of the camera focusing may be heard in the recorded movie. If you want to prevent the sound of the camera focusing from being recorded, select AF-S Single AF.</p>	 48
Wind noise reduction	<p>Set On or Off (default setting) to select whether wind noise is reduced when recording movies.</p>	 48

Movie Playback

1 Press the  (playback) button to enter playback mode.

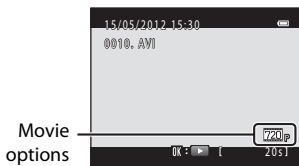

- Press the multi selector to choose the desired movie.
- Movies are indicated by the movie options icon ()78).



2 Press the  button.







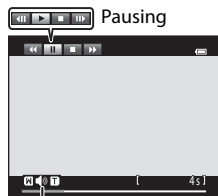









- The movie is played back.

Operation during Movie Playback

Playback controls are displayed at the top of the monitor. Press the multi selector  or  to choose a control. The operations described below are available.







Volume indicator During playback

To	Use	Description
Rewind		Hold down the  button to rewind movie.
Advance		Hold down the  button to advance movie.
Pause		Press the  button to pause playback. The following operations can be performed while playback is paused using the controls displayed at top in the monitor.
		 Press the  button to rewind the movie one frame. Hold down the  button for continuous frame-by-frame rewinding.
		 Press the  button to advance the movie one frame. Hold down the  button for continuous frame-by-frame advancing.
		Press the  button to resume playback.
End		Press the  button to return to full-frame playback mode.

Adjusting the Volume

Rotate the zoom control to **T** or **W** ()5) during movie playback.

Deleting a Movie File

To delete a movie, select the desired movie in full-frame playback mode (30) or thumbnail playback mode (31) and press the  button (32).

Note About Movie Playback

Movies recorded by a camera other than the COOLPIX S3300 cannot be played back.





A series of horizontal dashed lines for handwriting practice, spanning the width of the page.

General Camera Setup

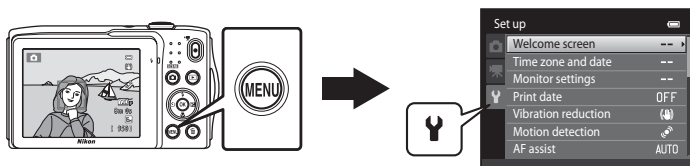
This chapter describes the various settings that can be adjusted in the  setup menu.



- See “Using Menus (the **MENU** Button)” (10) for information about using the camera’s menus.
- See “The Setup Menu” (49) in Reference Section for more information.







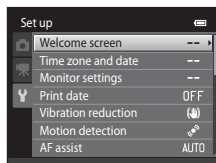





The Setup Menu

Press the **MENU** button → **Y** (setup) tab (📖10)











The following settings can be changed in the setup menu by selecting the **Y** tab.



Option	Description	
Welcome screen	Allows you to select the image displayed as the welcome screen when the camera is turned on. Select COOLPIX to display the COOLPIX logo. Select Select an image to use an image captured with the camera as the welcome screen.	49
Time zone and date	Allows you to set settings related to the camera's date and time. The Time zone setting allows you to specify the time zone where the camera is mainly used and whether or not daylight saving time is in effect. When the travel destination (📍) is selected, the camera automatically calculates the time difference between the travel destination and the home time zone (🏠), and saves images using the date and time of the travel destination.	50
Monitor settings	Allows you to select whether or not to display information on the shooting screen and playback screen. If you select Framing grid+auto info , a grid is displayed when shooting to help you frame the shot. The default setting is Auto info . You can also change the image review setting or the monitor brightness.	53
Print date	Allows you to imprint the shooting date and time on images at the time of shooting. The default setting is Off . <ul style="list-style-type: none"> The date cannot be imprinted in the following situations: <ul style="list-style-type: none"> When using Panorama assist scene mode When recording movies 	55

Option	Description	
Vibration reduction	<p>Allows you to reduce blurring caused by camera shake when shooting. The default setting is On.</p> <ul style="list-style-type: none"> When using a tripod to stabilize the camera during shooting, set this feature to Off to prevent this feature from malfunctioning. 	 56
Motion detection	<p>When the camera detects camera shake or subject movement at the time of shooting, it automatically increases ISO sensitivity and shutter speed to reduce blurring. The  indicator glows green when the camera detects camera shake and increases shutter speed. The default setting is Auto.</p> <ul style="list-style-type: none"> When using certain shooting modes or settings, motion is not detected. In this case the  indicator is not displayed. 	 57
AF assist	<p>When set to Auto, the AF-assist illuminator (2) lights up when shooting in dark surroundings to help the camera focus. The default setting is Auto.</p> <ul style="list-style-type: none"> The illuminator has a range of about 1.9 m (6 ft 2 in.) at the maximum wide-angle position and about 1.1 m (3 ft 7 in.) at the maximum telephoto position. Even if Auto is selected, the AF-assist illuminator may not light depending on the position of the focus area or the scene mode that is selected. 	 58
Digital zoom	<p>When set to On, rotating the zoom control to T (R) at the maximum optical zoom position triggers digital zoom feature (27). The default setting is On.</p>	 58
Sound settings	<p>Allows you to turn various camera sounds on and off. The Button sound and Shutter sound settings are On by default.</p> <ul style="list-style-type: none"> When using certain shooting modes or settings, the operation sound is disabled. 	 59
Auto off	<p>Allows you to set the amount of time that passes before the monitor turns off to save power. The default setting is 1 min.</p>	 59

The Setup Menu

Option	Description	
Format memory/ Format card	<p>Allows you to format the internal memory (only when a memory card is not inserted) or the memory card (when a memory card is inserted).</p> <ul style="list-style-type: none"> • All data stored in the internal memory or on the memory card is deleted during formatting and cannot be restored. Be sure to transfer important images to a computer and save them before formatting. 	 60
Language	Choose the language used for camera monitor display.	 61
Video mode	Adjust video mode settings for connection to a television. Select from NTSC and PAL .	 61
Charge by computer	<p>When set to Auto (default setting), you can charge the camera's battery by connecting the camera to a computer (provided that the computer is able to supply power).</p> <ul style="list-style-type: none"> • When charging by computer, it takes more time to charge the battery than when using the Charging AC Adapter EH-69P. Additionally, when charging by computer and transferring images to the computer simultaneously, it takes more time to charge the battery. 	 62
Blink warning	Immediately after taking a picture using face detection ( 64) (except when using smart portrait mode), if the camera detects a subject with closed eyes, the camera displays the message Did someone blink? , allowing you to check the image. The default setting is Off .	 64
Eye-Fi upload	Set whether or not to enable the function for sending images to a computer using a commercially available Eye-Fi card. The default setting is Disable .	 66
Reset all	Allows you to reset the camera's settings to their default values. Certain settings such as Time zone and date and Language are not reset.	 67
Firmware version	View the current camera firmware version.	 69



Reference Section

The Reference Section provides detailed information and hints for using the camera.

Shooting

Using Panorama Assist	2
-----------------------------	---

Playback

Favorite Pictures Mode.....	4
Auto Sort Mode	7
List by Date Mode	9
Editing Images (Still Images)	10
Connecting the Camera to a TV (Playback on a TV).....	17
Connecting the Camera to a Printer (Direct Print)	18

Menu





The Shooting Menu (for (Auto) Mode).....	24
Smart Portrait Menu	34
The Playback Menu.....	36
The Movie Menu	47
The Setup Menu.....	49

Additional Information

Image/Sound File and Folder Names.....	70
Optional Accessories	71
Error Messages	72











Using Panorama Assist

Use a tripod for the best results.

On the shooting screen →  (shooting mode) button →  (second icon from the top*) →  →  →  Panorama assist

* The icon for the last scene mode selected is displayed. The default setting is  (Scene auto selector).

1 Use the multi selector to choose the direction in which images will be joined and press the **OK** button.

- Panorama direction icons are displayed. Select the direction in which images will be joined in the completed panorama: right () , left () , up () or down () .
- The yellow panorama direction icon () is displayed for the current direction and the direction is fixed when **OK** is pressed. The icon changes to the white fixed direction  icon.
- If necessary, apply flash mode ()53, self-timer ()55, macro mode ()56 and exposure compensation ()57 settings with this step.
- Press the **OK** button again to choose a different direction.



2 Frame the first portion of the panorama scene and take the first picture.

- The camera focuses on the subject at the center of the frame.
- One third of the image will be displayed as translucent.



3 Take the next picture.

- Frame the next picture so that one third of the frame overlaps the first image, and press the shutter-release button.
- Repeat this process until the necessary number of picture has been taken to complete the scene.

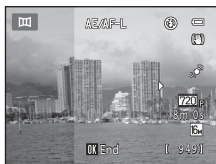

4 Press the **OK** button when shooting is complete.

- The camera returns to step 1.



✓ Notes About Panorama Assist

- Flash mode, self-timer, macro mode and exposure compensation settings cannot be adjusted after the first picture is taken. Images cannot be deleted, nor can zoom or **Image mode** setting (📖60) be adjusted after the first picture has been taken.
- Shooting for the panorama series is terminated if the auto off function (🔌59) initiates standby mode during shooting. Setting the time allowed to elapse before the auto off function is enabled to a longer setting is recommended.

📌 AE/AF-L Indicator

In **Panorama assist** scene mode, exposure, white balance, and focus for all images in a panorama are fixed at the values for the first image in each series.

When the first picture is taken, **AE/AF-L** is displayed to indicate that exposure, white balance, and focus are locked.



📌 Panorama Creation with Panorama Maker 6

- Transfer images to a computer (📖75) and use Panorama Maker 6 to join them in a single panorama.
- Panorama Maker 6 can be installed on a computer using the included ViewNX 2 Installer CD (📖73).
- After installation is complete, follow the procedure described below to start Panorama Maker 6.
Windows: Choose **Start** menu>**All Programs**>**ArcSoft Panorama Maker 6**>**Panorama Maker 6**.
Mac OS X: Open **Applications** and double-click the **Panorama Maker 6** icon.
- For more information on using Panorama Maker 6, refer to the on-screen instructions and help information contained in Panorama Maker 6.

📌 More Information

See "Image/Sound File and Folder Names" (🔌70) for more information.

Favorite Pictures Mode

You can sort your favorite pictures into nine albums (this option is not available for movies). Once they are added, you can choose to play back only favorite pictures by selecting favorite pictures mode.

- Categorizing albums by theme or type of subject makes it easier to find a particular picture.
- A single picture can be added to multiple albums.
- Up to 200 pictures can be added to each album.

Adding Images to Albums

1 Select a favorite image in full-frame playback mode or in thumbnail playback mode and press the **OK** button.

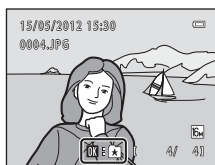

- In favorite pictures mode, images cannot be added to albums.



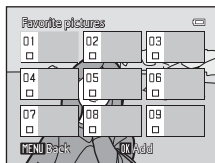



2 Press the multi selector to choose a desired album and press the **OK** button.



Viewing Images in an Album



Press the  button (playback mode) →  button →  Favorite pictures

Use the multi selector to select an album and then press the  button to play back the images that have been added to the selected album.

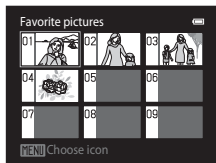
- The following operations are available from the album selection screen.
 - **MENU** button: Changes the album icon ().
 -  button: Deletes all images in the selected album.
- When viewing images in full-frame playback mode or thumbnail playback mode, press the **MENU** button to select a feature from the favorite pictures menu (71).



Removing Images from Albums

Press the  button in full-frame playback mode in favorite pictures mode to remove the image. A confirmation dialog is displayed. Choose **Yes** and press the  button to remove the image from the album.

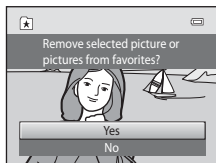

Note About Deleting Images in Favorite Pictures Mode

When images are added to albums, they are not physically copied to albums or moved from the folder to which they were originally recorded. Only the file names of images are added to albums. In favorite pictures mode, the images corresponding to the file names in the specified album are played back.

Deleting an image in favorite pictures mode deletes not only the image from the album, but also deletes the image file from the internal memory or memory card permanently.

Changing Icons Assigned to Albums

From the album selection screen (📖70, 📷5), select an album and press the **MENU** button to change the album's icon.

- Select a color, press the **OK** button, and select an icon and press the **OK** button to change the icon.







✓ Notes About Icons for Albums



- Choose icons for albums separately for the internal memory and for every memory card used.
- To change the icon for an album containing images stored in the internal memory, remove the memory card from the camera.
- The default setting for icons is the number icon (black).

Auto Sort Mode

Images are automatically sorted into categories, such as portraits, landscapes, and movies.







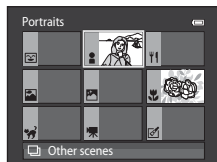

















Press the  button (playback mode) →  button →  Auto sort mode

Use the multi selector to select a category and then press the  button to play back the images in the selected category.

- The following operation is available while the category selection screen is displayed.
 -  button: Deletes all images in the selected category.
- When viewing images in full-frame playback mode or thumbnail playback mode, press the **MENU** button to select a feature from the auto sort menu (71).





Auto Sort Mode Categories

Category	Description
 Smile	Images captured in smart portrait mode ( 49) with the smile timer setting set to On .
 Portraits	Images captured in  (auto) mode ( 36) with face detection ( 64). Images captured in Portrait* , Night portrait* , Party/indoor , and Backlighting* scene modes ( 39). Images captured in smart portrait mode ( 49) with the smile timer setting set to Off .
 Food	Images captured in Food scene mode ( 39).
 Landscape	Images captured in Landscape* scene mode ( 39).
 Dusk to dawn	Images captured in Night landscape* , Sunset , Dusk/dawn and Fireworks show scene modes ( 39).
 Close-ups	Images captured in  (auto) mode with the macro mode setting ( 56). Images captured in Close-up* scene mode ( 39).
 Pet portrait	Images captured in Pet portrait scene mode ( 39).
 Movie	Movies ( 78).
 Retouched copies	Copies created using editing functions ( 10).
 Other scenes	All other images that cannot be defined by the categories described above.



* Images captured in scene auto selector scene mode (40) are also sorted into the appropriate categories.

Auto Sort Mode





Notes About Auto Sort Mode

- Up to 999 images and movie files can be sorted into each category in auto sort mode. If 999 images or movies have already been sorted into a specific category, new images and movies cannot be sorted into that category nor can they be displayed in auto sort mode. Display images and movies that could not be sorted into a category in normal playback mode (30) or list by date mode (.
- Images or movies copied from the internal memory to a memory card, or vice versa, cannot be displayed in auto sort mode (.
- Images or movies recorded by a camera other than the COOLPIX S3300 cannot be displayed in auto sort mode.

List by Date Mode

Press the  button (playback mode) →  button →  List by date

Select a date with the multi selector, and press the  button to play back images captured on the selected date.

- The first image captured on the selected date is displayed.
- The following operations are available while the shooting date selection screen is displayed.
 - **MENU** button: You can select one of the following functions in the list by date menu ( 71) and apply it to all images captured on the selected date.
 - print order, slide show, protect
 -  button: Deletes all images captured on the selected date.
- When viewing images in full-frame playback mode or thumbnail playback mode, press the **MENU** button to select a feature from the list by date menu ( 71).
- Calendar display ( 31) is not available in list by date mode.



Notes About List by Date Mode

- Up to 29 dates can be selected. If images exist for more than 29 dates, all images saved earlier than most recent 29 dates will be combined under **Others**.
- Up to 9,000 of the most recently recorded images can be displayed in list by date mode.
- Images captured when the camera's date is not set are treated as images captured on January 1, 2012.

Editing Images (Still Images)

Editing Functions

Use the COOLPIX S3300 to edit images in-camera and store them as separate files (70). The editing functions described below are available.

Editing function	Description
Quick retouch (12)	Easily create retouched copies in which contrast and saturation have been enhanced.
D-Lighting (12)	Create a copy of the current image with enhanced brightness and contrast, brightening dark portions of the image.
Glamour retouch (13)	Make facial skin tone softer and make faces look smaller with larger eyes.
Filter effects (14)	Apply a variety of effects using digital filter. The available effects are Soft , Selective color , Cross screen , Fisheye , Miniature effect , and Painting .
Small picture (15)	Create a small copy of images suitable for use as e-mail attachments.
Crop (16)	Enlarge the image or refine the composition and create a copy containing only the portion visible in the monitor.

Notes About Image Editing

- Images captured at an **Image mode** setting of  **4608x2592** (60) cannot be edited.
- The COOLPIX S3300 editing functions are not available for images captured with another make or model of digital cameras.
- If no face is detected in an image, a copy cannot be created using the glamour retouch option (13).
- Edited copies created with COOLPIX S3300 may not be displayed properly on another make or model of digital camera. It may also be impossible to transfer them to a computer using another make or model of digital camera.
- Editing functions are not available when there is not enough free space in the internal memory or on the memory card to store the edited copies.



Restrictions on Image Editing

When an edited copy is further modified with another editing function, check the following restrictions.



Editing function used	Editing function to use
Quick retouch D-Lighting Filter effects	The glamour retouch, small picture or crop functions can be used. The quick retouch, D-Lighting, and filter effects functions cannot be used together.
Glamour retouch	An editing function other than glamour retouch can be used.
Small picture Crop	Another editing function cannot be used.



- Copies created with an editing function cannot be further edited with the same function used to create them.
- When combining the small picture or crop function and another editing function, use the small picture or crop function after other editing function has been applied.
- Retouch effects such as the glamour retouch function's skin softening effect can be applied to images captured with the skin softening function (34).



Original and Edited Images

- Copies created with editing functions are not deleted when the original images are deleted, and the original images are not deleted when copies created with editing functions are deleted.
- Edited copies are stored with the same recording date and time as the original.
- Print order (36) and protect settings (41) of the original image are not applied to edited copies.

Quick Retouch: Enhancing Contrast and Saturation



Press the  button (playback mode) → select an image → MENU button →  Quick retouch

Press the multi selector  or  to choose the degree of enhancement performed and press the  button.

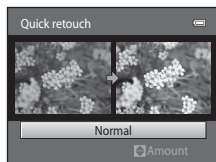
- The original version is displayed on the left and the edited version is displayed on the right.
- To exit without saving the copy, press .
- Copies created with the quick retouch option can be recognized by the  icon displayed during playback.



D-Lighting: Enhancing Brightness and Contrast

Press the  button (playback mode) → select an image → MENU button →  D-Lighting

Use the multi selector to select **OK** and press the  button.

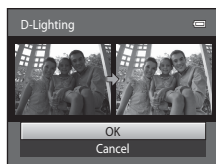

- The original version is displayed on the left and the edited version is displayed on the right.
- D-Lighting copies can be recognized by the  icon displayed during playback.



More Information

See "Image/Sound File and Folder Names" ( 70) for more information.

Glamour Retouch: Softening Skin and Making Faces Looking Smaller with Larger Eyes

Press the  button (playback mode) → select an image → MENU button →  Glamour retouch

1 Press the multi selector ▲ or ▼ to choose All or Skin softening and press the OK button.

- **All:** Soften facial skin tones, make faces look smaller, and make eyes look larger.
- **Skin softening:** Soften facial skin tones.
- The preview screen is displayed.
- To exit without saving the copy, press ◀.

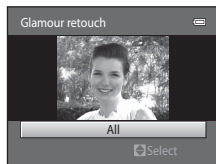

2 Preview the result of the effects.

- Skin tones in up to 12 faces, in the order of that closest to the center of the frame, are softened.
- If more than one face was softened, press the multi selector ◀ or ▶ to display a different face.
- To change the degree of effect, press the MENU button and return to step 1.
- When the OK button is pressed, a new, edited copy is created.
- Copies created with the glamour retouch option can be recognized by the  icon displayed in playback mode.

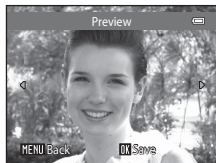



Notes About Glamour Retouch

- The glamour retouch function may not perform as expected depending on the direction in which the faces are looking or the brightness of the faces in the image.
- If no faces are detected in the image, a warning is displayed and the screen returns to the playback menu.

More Information

See "Image/Sound File and Folder Names" (70) for more information.

Filter Effects: Applying Digital Filter Effects

Press the  button (playback mode) → select an image → MENU button →  Filter effects

Type	Description
Soft	Give the image a soft look by blurring from the center outward. In images captured with face detection (📖64) or pet detection (📖46) selected, areas around faces will be blurred.
Selective color	Keep one specified color in the image, and change the other colors to black and white.
Cross screen	Produce star-like rays of light that radiate outward from bright objects such as sunlight reflections and city lights. This effect is suitable for night scenes.
Fisheye	Make an image look as if it were captured with a fisheye lens. This effect is well-suited for images captured in macro mode.
Miniature effect	Make an image look like a miniature scene captured in macro mode. This effect is well-suited for images captured from a high vantage point with the main subject at the center of the image.
Painting	Give images a hand-painted appearance.

1 Press the multi selector ▲ or ▼ to select the type of the effects and press the  button.

- When **Cross screen**, **Fisheye**, **Miniature effect**, or **Painting** is selected, proceed to step 3.

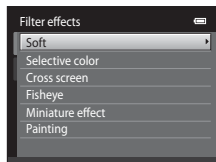

2 Adjust the effect and press the  button.

- When using **Soft**: Press ▲ or ▼ to select the size of the area to soften.
- When using **Selective color**: Press ▲ or ▼ to select the color to keep.
- Press ◀ to return to the **Filter effects** selection screen without making any changes.

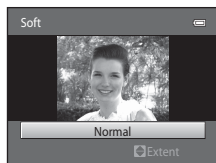



Example: **Soft**

3 Check the results, and press the **OK** button.

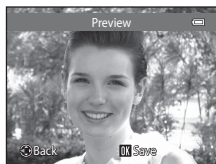
- A new, edited copy is created.
 - To exit without saving the copy, press **◀**.
-
- Copies created with the filter effects option can be recognized by the  icon displayed in playback mode.

**Small Picture: Reducing Image Size**

Press the  button (playback mode) → select an image → **MENU** button →

 Small picture

1 Press the multi selector **▲** or **▼** to choose the desired copy size and press the **OK** button.

- The **640×480**, **320×240**, and **160×120** sizes are available.

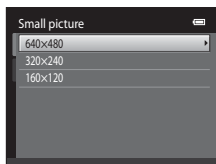

**2** Choose **Yes** and press the **OK** button.

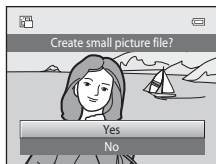
- A new, smaller copy is created (compression ratio of approximately 1:16).
- The copy is displayed with a black frame.

**More Information**







See "Image/Sound File and Folder Names" ( 70) for more information.

Crop: Creating a Cropped Copy

Create a copy containing only the portion visible in the monitor when **MENU**  is displayed with playback zoom (31) enabled. Cropped copies are stored as separate files.

1 Enlarge the image for cropping (.

2 Refine copy composition.

- Rotate the zoom control to **T** () or **W** () to adjust the zoom ratio.
- Press the multi selector , , , or  to scroll the image until only the portion you want to copy is visible in the monitor.



3 Press the **MENU** button.

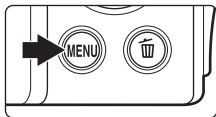

4 Use the multi selector to choose **Yes** and press the  button.

- A cropped copy is created.

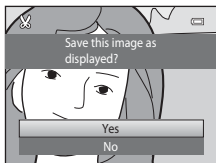



Image Size

As the area to be saved is reduced, the image size (pixels) of the cropped copy is also reduced. When the size of the cropped copy is 320 × 240 or 160 × 120, a black frame is displayed around the image during playback, and the small picture icon  is displayed at the left of the monitor.

Cropping the Picture in its Current “Tall” Orientation

Use the **Rotate image** option (43) to rotate the image so that it is displayed in landscape orientation. After cropping the image, rotate the cropped image back to “tall” orientation. The image displayed in “tall” orientation can be cropped by zooming in on the image until the black bars displayed on the both sides of the monitor disappear. The cropped image is displayed in landscape orientation.

More Information

See “Image/Sound File and Folder Names” (70) for more information.

Connecting the Camera to a TV (Playback on a TV)

Connect the camera to a television using the included audio/video cable to play back images on a television.

1 Turn off the camera.

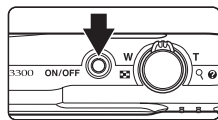

2 Connect the camera to the TV.

- Connect the yellow plug to the video-in jack and the white plug to the audio-in jack on the TV.
- Be sure that plugs are properly oriented. Do not attempt to insert plugs at an angle, and do not use force when connecting or disconnecting the plugs.

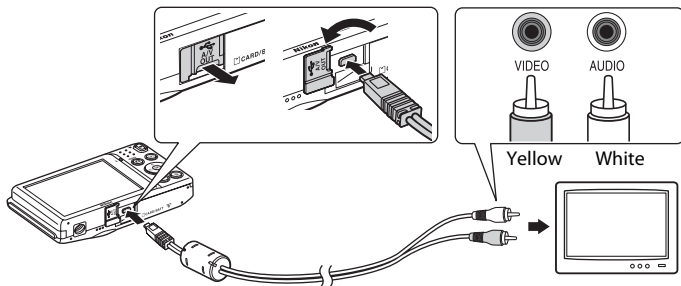

3 Tune the television to the video channel.



- See the documentation provided with your television for details.

4 Hold down the button to turn on the camera.

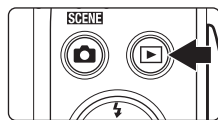
- The camera enters playback mode and images are displayed on the television.
- While connected to the TV, the camera monitor will remain off.



If Images are not Displayed on the TV

Be sure that the camera's video mode setting conforms to the standard used by your television. Specify the **Video mode** option () in the setup menu (.

Connecting the Camera to a Printer (Direct Print)

Users of PictBridge-compatible (🔦17) printers can connect the camera directly to the printer and print images without using a computer. Follow the procedures below to print images.

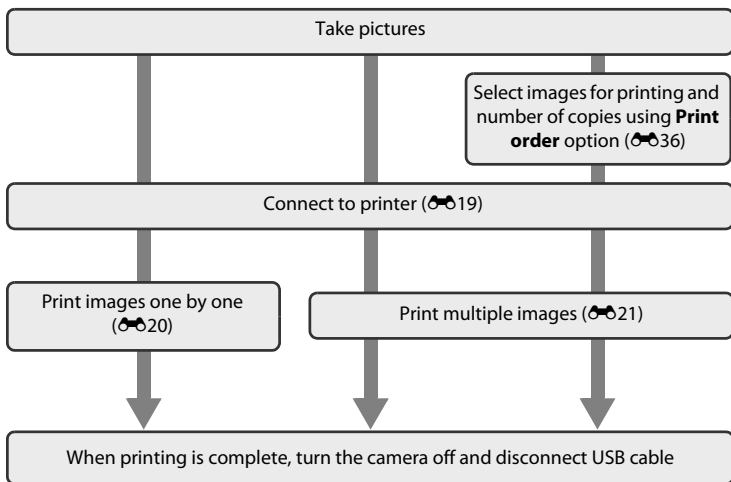

✔ Notes About Power Source

- When connecting the camera to a printer, use a fully charged battery to prevent the camera from turning off unexpectedly.
- If the AC Adapter EH-62G (available separately) is used, COOLPIX S3300 can be powered from a home electrical outlet. Do not use any other make or model of AC adapter as they may cause the camera to heat up or malfunction.

📎 Printing Images

Images saved on a memory card can be printed by transferring the images to a computer or connecting the camera directly to a printer. The following printing methods are also available:

- Inserting a memory card into a DPOF-compatible printer's card slot
- Taking a memory card to a digital photo lab

For printing using these methods, specify the images and the number of prints each to the memory card using the **Print order** option in the playback menu (🔦36).

Connecting the Camera to a Printer

- 1 Turn off the camera.

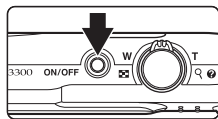

- 2 Turn on the printer.

- Check printer settings.

- 3 Connect the camera to the printer using the included USB cable.

- Be sure that plugs are properly oriented. Do not attempt to insert plugs at an angle, and do not use force when connecting or disconnecting the plugs.

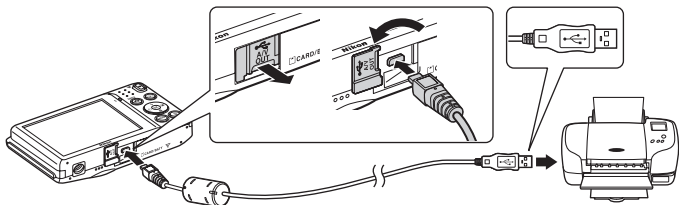

- 4 The camera is automatically turned on.

- When properly connected, the **PictBridge** startup screen (①) will be displayed in the camera monitor, followed by the **Print selection** screen (②).

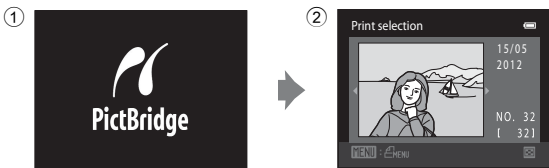
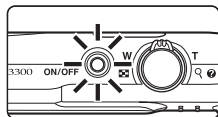

✔ If the PictBridge Screen is not Displayed

Turn off the camera and disconnect the USB cable. Set **Charge by computer** (6062) in the camera's setup menu to **Off**, then connect the camera again.

Printing Images One by One

After properly connecting the camera to the printer (📷19), follow the procedure described below to print an image.

1 Use the multi selector to choose the desired image and press the **OK** button.

- Rotate the zoom control to **W** (📷) to switch to 12-thumbnail display, and to **T** (📷) to switch back to full-frame playback.

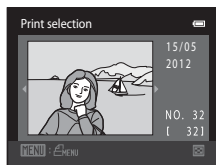

2 Choose **Copies** and press the **OK** button.

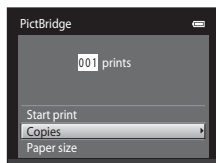

3 Choose the number of copies (up to nine) and press the **OK** button.

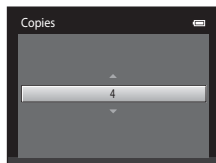

4 Choose **Paper size** and press the **OK** button.

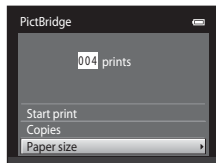

5 Choose the desired paper size and press the **OK** button.

- To specify paper size using printer settings, choose **Default** in the paper size menu.

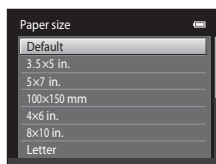

- 6** Choose **Start print** and press the **OK** button.

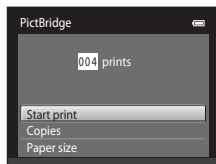

- 7** Printing begins.

- Monitor display returns to the print selection screen shown in step 1 when printing is complete.
- To cancel printing before all copies have been printed, press the **OK** button.

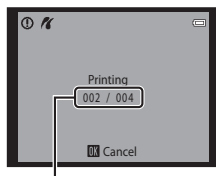

Current number of copies/total number of copies

Printing Multiple Images

After properly connecting the camera to the printer (📷19), follow the procedure described below to print multiple images.

- 1** When the **Print selection** screen is displayed, press the **MENU** button.

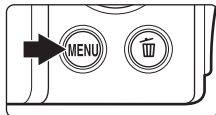

- 2** Use the multi selector to choose **Paper size** and press the **OK** button.

- To exit the print menu, press the **MENU** button.

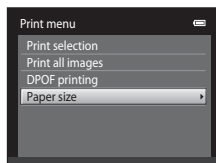

3 Choose the desired paper size and press the **OK** button.

- To specify paper size using printer settings, choose **Default** in the paper size menu.

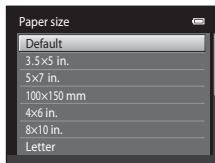

4 Choose **Print selection**, **Print all images** or **DPOF printing** and press the **OK** button.

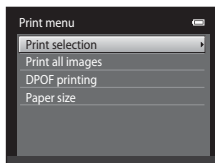

Print selection

Choose images (up to 99) and the number of copies (up to nine) of each.

- Press the multi selector **◀** or **▶** to select images, and press **▲** or **▼** to specify the number of copies for each.
- Image selected for printing can be recognized by the check mark (☑) and the numeral indicating the number of copies to be printed.

If no copies have been specified for images, the selection is canceled.

- Rotate the zoom control to **T** (🔍) to switch to full-frame playback. Rotate the zoom control to **W** (📐) to switch back to 12-thumbnail display.
- Press the **OK** button when setting is complete.
- When the menu shown at right is displayed, choose **Start print** and press the **OK** button to start printing. Choose **Cancel** and press the **OK** button to return to the print menu.

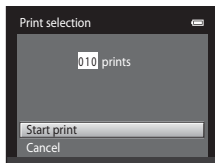

Print all images

One copy each of all images stored in the internal memory, or on the memory card, is printed.

- When the menu shown at right is displayed, choose **Start print** and press the **OK** button to start printing. Choose **Cancel** and press the **OK** button to return to the print menu.

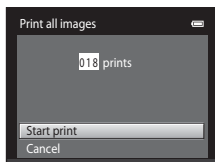
**DPOF printing**

Print images for which a print order was created using the **Print order** option (36).

- When the menu shown at right is displayed, choose **Start print** and press the **OK** button to start printing. Choose **Cancel** and press the **OK** button to return to the print menu.
- To view the current print order, choose **View images** and press the **OK** button. To print images, press the **OK** button again.

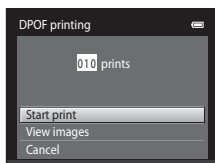
**5 Printing begins.**

- The monitor display returns to the print menu shown in step 2 when printing is complete.
- To cancel printing before all copies have been printed, press the **OK** button.

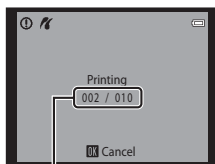

Current number of copies/total number of copies

Paper Size

The camera supports the following paper sizes: **Default** (the default paper size for the current printer), **3.5x5 in.**, **5x7 in.**, **100x150 mm**, **4x6 in.**, **8x10 in.**, **Letter**, **A3**, and **A4**. Only sizes supported by the current printer will be displayed.







The Shooting Menu (for (Auto) Mode)

- See “Changing the Image Size (Image Mode)” (60) for information about **Image mode**.

White Balance (Adjusting Hue)



On the  (auto) mode shooting screen → MENU button → White balance

The color of light reflected from an object varies with the color of the light source. The human brain is able to adapt to changes in the color of the light source, with the result that white objects appear white whether seen in the shade, direct sunlight, or under incandescent lighting. Digital cameras can mimic this adjustment by processing images according to the color of the light source. This is known as “white balance.” For natural colors, choose a white balance setting that matches the light source before shooting. Although the default setting, **Auto**, can be used under most types of lighting, the white balance setting suited to a particular light source can be specified manually to achieve more accurate results.

Option	Description
AUTO Auto (default setting)	White balance automatically adjusted to suit lighting conditions. Best choice in most situations.
PRE Preset manual	Neutral-colored object used as reference to set white balance under unusual lighting conditions. See “Preset Manual” for more information ( 25).
 Daylight	White balance adjusted for direct sunlight.
 Incandescent	Use under incandescent lighting.
 Fluorescent	Use under fluorescent lighting.
 Cloudy	Use when taking pictures under overcast skies.
 Flash	Use with the flash.

The icon for the current setting is displayed in the monitor (6). However, when **Auto** is selected, no icon is displayed.



Notes About White Balance

- There are functions with which this setting cannot be enabled. See “Functions That Cannot Be Applied Simultaneously” (62) for more information.
- At white-balance settings other than **Auto** or **Flash**, turn the flash off ( 53).

Preset Manual

The preset manual option is effective with mixed lighting or to compensate for light sources with a strong color cast when the desired effect has not been achieved with white balance settings like **Auto** and **Incandescent** (for example, to make pictures taken under a lamp with a red shade look as though they had been shot under white light). Follow the procedure below to measure the white balance value according to the light source when shooting.

1 Place a white or gray reference object under the lighting that will be used during shooting.

2 Display shooting menu (, 10, 37), use the multi selector to choose **PRE Preset manual** in the **White balance** menu and press the  button.

- The camera zooms in to the position for measuring white balance.

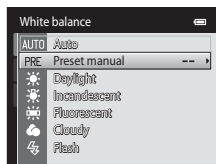

3 Choose **Measure**.

- To apply the most recently measured value for preset manual, choose **Cancel** and press the  button. The white balance setting will not be measured again and the most recently measured value will be set.

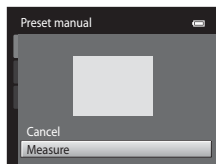

4 Frame the reference object in the measuring window.

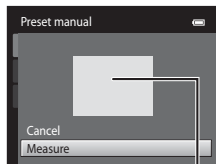

Measuring window

5 Press the  button to measure a new white balance value.

- The shutter is released and the new white balance value for preset manual is set. No image is saved.





Note About Preset Manual

A value for flash lighting cannot be measured with **Preset manual**. When shooting using the flash, set **White balance** to **Auto** or **Flash**.

Continuous

On the  (auto) mode shooting screen → MENU button → Continuous

Enable continuous shooting or **BSS** (Best Shot Selector).

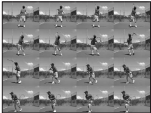
Option	Description
 Single (default setting)	One picture is taken each time the shutter-release button is pressed.
 Continuous	While the shutter-release button is held down, up to 6 pictures are taken at a rate of about 1.3 frames per second (fps) when Image mode is set to  4608x3456 .
BSS BSS (Best Shot Selector)	The “Best Shot Selector” is recommended when shooting with the flash off or the camera zoomed in, or in other situations in which inadvertent motion can result in blurred images. When BSS is on, the camera takes up to ten pictures while the shutter-release button is held down. The sharpest image in the series is automatically selected and saved.
 Multi-shot 16	Each time the shutter-release button is pressed, camera takes 16 shots at a rate of about 30 fps and arranges them in a single image. <ul style="list-style-type: none"> • Image mode is fixed at  (2560 × 1920). • Digital zoom is not available. 

At settings other than **Single**, the indicator for the current setting is displayed in the monitor (6).

Notes About Continuous Shooting

- When **Continuous**, **BSS**, or **Multi-shot 16** is selected, flash is disabled. Focus, exposure, and white balance are fixed at the values determined with the first image in each series.
- The frame rate with continuous shooting may vary depending upon the current image mode setting, the memory card used, or shooting condition.
- There are functions with which this setting cannot be enabled. See “Functions That Cannot Be Applied Simultaneously” (62) for more information.

Note About BSS

BSS is effective when taking pictures of still subjects. **BSS** may not produce the desired results if the subject moves or the composition changes while the shutter-release button is held down.

Note About Multi-shot 16

Smear (3) visible in the monitor when shooting with **Multi-shot 16** enabled will be recorded with images. Avoiding bright objects such as the sun, reflections of the sun, and electric lights when shooting with **Multi-shot 16** enabled is recommended.

ISO Sensitivity



On the  (auto) mode shooting screen → MENU button → ISO sensitivity

The higher the sensitivity, the less light is needed to expose an image, allowing capturing darker subjects. Additionally, even with subjects of similar brightness, pictures can be taken at faster shutter speeds, and blurring caused by camera shake and subject movement can be reduced.



- Although higher ISO sensitivity is effective when shooting darker subjects, shooting without the flash, shooting while using the zoom, etc., images may contain noise.

Option	Description
Auto (default setting)	Sensitivity is ISO 80 when there is sufficient lighting; the camera compensates by raising sensitivity to a maximum of ISO 1600 when lighting is dim.
Fixed range auto	Choose the range in which the camera automatically adjusts ISO sensitivity from ISO 80-400 (default setting) and ISO 80-800 . The camera will not increase sensitivity beyond the maximum value in the selected range. Specify the maximum ISO sensitivity for effective control over the amount of "grain" that appears in images.
80, 100, 200, 400, 800, 1600, 3200	Sensitivity is locked at the specified value.





The current ISO sensitivity setting is indicated by an icon when shooting ( 6).

- When **Auto** is selected, the  icon is not displayed at ISO 80, but is displayed if the ISO sensitivity automatically increases to more than 80.
- When **Fixed range auto** is selected,  and the maximum value of ISO sensitivity is displayed.

Notes About ISO sensitivity

- There are functions with which this setting cannot be enabled. See "Functions That Cannot Be Applied Simultaneously" ( 62) for more information.
- **Motion detection** ( 57) does not function when the ISO sensitivity is set to any setting other than **Auto**.

ISO 3200





When **ISO sensitivity** is set to **3200**, the available **Image mode** settings are limited to  **2272x1704**,  **1600x1200**, and  **640x480**.  is displayed next to the ISO sensitivity indicator in the bottom left of the monitor.

ISO 3200

Color Options

On the  (auto) mode shooting screen → MENU button → Color options

Make colors more vivid or save images in monochrome.

Option	Description
 Standard color (default setting)	Use for images exhibiting natural color.
 Vivid color	Use to achieve a vivid, "photoprint" effect.
 Black-and-white	Save images in black-and-white.
 Sepia	Save images in sepia tones.
 Cyanotype	Save images in cyan-blue monochrome.

At settings other than **Standard color**, the icon for the current setting is displayed in the monitor (6). Color tones in shooting display change according to the selected color option.



Note About Color Options





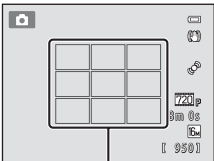

There are functions with which this setting cannot be enabled. See "Functions That Cannot Be Applied Simultaneously" (62) for more information.

AF Area Mode

On the  (auto) mode shooting screen → MENU button → AF area mode



Use this option to determine how the camera selects the focus area for autofocus.

Option	Description
 Face priority (default setting)	<p>When the camera detects a human face, it focuses on that face. See “Face Detection” (p.64) for more information. If more than one face is detected, the camera focuses on the face closest to the camera. When taking pictures of subjects other than people, or framing a subject with which no face is detected, the AF area mode setting switches to Auto, and the camera automatically selects the focus area (up to nine areas) containing the subject closest to the camera and focus on it.</p>  <p style="text-align: center;">Focus area</p>
 Auto	<p>The camera automatically selects the focus area (up to nine areas) containing the subject closest to the camera and focuses on it. Press the shutter-release button halfway to activate the focus area. When the shutter-release button is pressed halfway, the focus area (up to nine areas) selected by the camera will be displayed in the monitor.</p>  <p style="text-align: center;">Focus area</p>

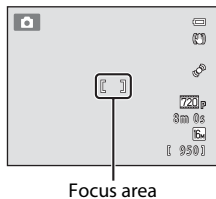
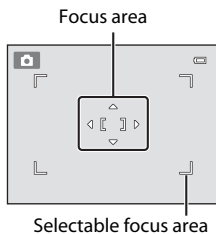
Option	Description
 Manual	<p>Select one of 99 focus areas in the monitor. This option is suited to situations in which the intended subject is relatively still and not positioned at the center of the frame. Press the multi selector ▲, ▼, ◀, or ▶ to move the focus area to the position where you want to focus, and then shoot.</p> <ul style="list-style-type: none"> Before making any of the settings below, press the  button to cancel the focus-area selection. <ul style="list-style-type: none"> Flash mode Macro mode, self-timer, or exposure compensation <p>When the settings are complete, press the  button again to reactivate the focus-area selection.</p>
 Center	<p>The camera focuses on the subject at the center of the frame. The center focus area is always displayed.</p>
 Subject tracking	<p>Use this function to take pictures of moving subjects. Register the subject on which the camera will focus. The focus area will automatically move to track the subject. See “Using Subject Tracking” (32) for more information.</p>



Notes About AF Area Mode



- When digital zoom is in effect, focus will be on the center of the screen regardless of the **AF area mode** setting.
- Autofocus may not perform as expected (29).
- There are functions with which this setting cannot be enabled. See “Functions That Cannot Be Applied Simultaneously” (62) for more information.

Using Subject Tracking

On the  (auto) mode shooting screen → MENU button → AF area mode → Subject tracking

Use this function to take pictures of moving subjects. When a subject is registered, the camera automatically moves the focus area to track the subject. If the camera detects a human face, it automatically registers the human face and begins tracking that face.

1 Register a subject.

- When a face is not detected and the white border is displayed at the center of the monitor, align the subject with the border and press the  button.
- When the border glows red, the camera is unable to focus on the subject. Change the composition and try to register the subject again.
- When the subject is registered, a yellow focus area is displayed on that subject and the camera begins tracking that subject.
- To deregister the subject, press the  button.
- If the camera cannot track the registered subject anymore, the focus area will disappear and the registration will be canceled. Register the subject again.
- When a face is detected, the camera automatically registers the face.

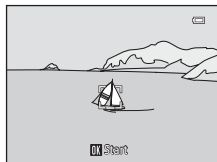

2 Press the shutter-release button all the way down to take a picture.

- The camera focuses on the focus area when the shutter-release button is pressed halfway. The focus area will glow green and focus will be locked.
- If the focus area is not displayed when the shutter-release button is pressed halfway, the camera focuses on the subject at the center of the frame.

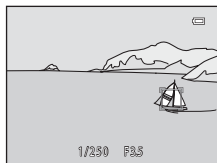

Notes About Subject Tracking Mode

- Adjust zoom position, flash mode, exposure compensation, and menu settings prior to registering the subject.
- Subject tracking may not be possible in certain shooting conditions.
- If the camera detects more than one face in the monitor, you cannot specify the face to register. Do not include faces in the frame when you want to track a subject other than faces.
- Digital zoom is not available.



Autofocus Mode

On the  (auto) mode shooting screen → MENU button → Autofocus mode

Choose how the camera focuses.

Option	Description
AF-S Single AF (default setting)	The camera focuses when the shutter-release button is pressed halfway.
AF-F Full-time AF	The camera focuses continuously until the shutter-release button is pressed halfway. Use with moving subjects. The sound of lens drive movement will be heard while the camera focuses.

Autofocus Mode for Movie Recording

Autofocus mode for movie recording can be set with **Autofocus mode** (48) in the movie menu (47).

Smart Portrait Menu

- See “Changing the Image Size (Image Mode)” (📖60) for information about **Image mode**.

Skin Softening

On the smart portrait mode screen → MENU button → Skin softening

Enable skin softening.

Option	Description
⬆️⬆️ High	When the shutter is released, the camera detects one or more human faces (up to three), and processes the image to soften facial skin tones before saving the image. You can select the amount of effect that is applied.
⬆️ Normal (default setting)	
⬆️ Low	
OFF Off	Turns skin softening off.

The current skin softening setting is indicated by an icon displayed in the monitor during shooting (📖6). No indicator is displayed when **Off** is selected. The effects of skin softening are not visible when framing pictures for shooting. Check the degree of skin softening performed in playback mode.

Smile Timer

On the smart portrait mode screen → MENU button → Smile timer

The camera detects human faces and then automatically releases the shutter whenever a smile is detected.

Option	Description
📷 On (default setting)	Enables smile timer.
OFF Off	Turns the smile timer off.

The current smile timer setting is indicated by an icon displayed in the monitor during shooting (📖6). No icon is displayed when **Off** is selected.

Blink Proof

On the smart portrait mode screen → MENU button → Blink proof

The camera automatically releases the shutter twice each time a picture is taken. Of the two shots, one in which the subject's eyes are open is saved.

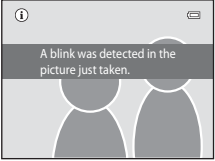
Option	Description
 On	<p>Enables blink warning. Flash cannot be used when On is selected.</p> <p>If the camera saved an image in which the subject's eyes may have been closed, the dialog shown on the right is displayed for a few seconds.</p> 
OFF Off (default setting)	Turns the blink warning off.

The current blink proof setting is indicated by an icon when shooting (📖6). No icon is displayed when **Off** is selected.

The Playback Menu

- See “Editing Images (Still Images)” (🔍10) for information about image editing features.

🖨️ Print Order (Creating a DPOF Print Order)

Press the  button (playback mode) → MENU button → 🖨️ Print order

When printing images stored on the memory card using any of the following methods, the **Print order** option in the playback menu is used to create digital “print orders” for printing on DPOF-compatible devices.



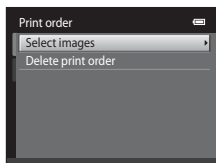

- Inserting the memory card into a DPOF-compatible (🔍17) printer’s card slot.
- Taking the memory card to a digital photo lab.
- Connecting the camera to a PictBridge-compatible (🔍17) printer (🔍18). A print order can also be created for images stored in the internal memory if the memory card is removed from the camera.

1 Use the multi selector to select **Select images** and press the button.

- In favorite pictures, auto sort, or list by date mode, the screen shown on the right is not displayed. Proceed to the step 2.



2 Choose images (up to 99) and the number of copies (up to nine) of each.

- Press the multi selector  or  to select images, and press  or  to specify the number of copies to be printed.
- Image selected for printing can be recognized by the check mark (✔️) icon and the numeral indicating the number of copies to be printed. If no copies have been specified for images, the selection is canceled.
- Rotate the zoom control to **T** (🔍) to switch to full-frame playback. Rotate the zoom control to **W** (🖼️) to switch back to 12-thumbnail display.
- Press the  button when setting is complete.



3 Choose whether or not to print shooting date and photo information.

- Choose **Date** and press the **OK** button to print the shooting date on all images in the print order.
- Choose **Info** and press the **OK** button to print shutter speed and aperture value information on all images in the print order.
- Choose **Done** and press the **OK** button to complete the print order and exit.

Images selected for printing are recognized by the  icon displayed with playback.

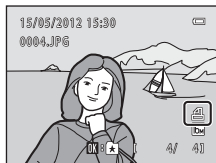
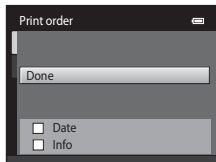

✓ Notes About Print Order

When a print order is created in favorite pictures mode, auto sort mode or list by date mode, the screen shown below is displayed if images other than those in the selected album, or category, or captured on the selected shooting date, have been marked for printing.

- Select **Yes** to mark the selected images for printing without changing the marking of other images.
- Select **No** to remove all print markings from previously marked images and restrict the print order to images in the selected album or category, or captured on the selected shooting date.

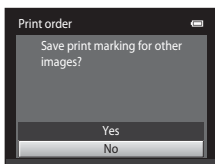

Favorite pictures mode/
auto sort mode

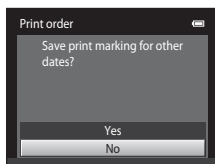

List by date mode

If the total number of marked images exceeds 99 as a result of adding the current print order setting, the screen shown below will be displayed.

- Select **Yes** to remove all print markings previously added from the print order and restrict the print order to images just marked.
- Select **Cancel** to cancel the settings that were just added without changing the print marking for previously marked images.

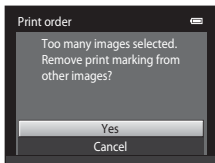

Favorite pictures mode/
auto sort mode

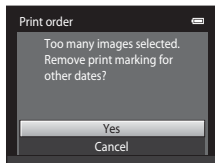

List by date mode

✔ Notes About Printing Shooting Date and Photo Information

When the **Date** and **Info** options are enabled in the print order option, shooting date and photo information are printed on images when a DPOF-compatible (🔗17) printer which supports printing of shooting date and photo information is used.

- Photo information cannot be printed when the camera is connected directly to a printer, via the included USB cable, for DPOF printing (🔗23).
- Note that **Date** and **Info** settings are reset when the **Print order** option is displayed.
- The date printed is that saved when the image was captured.
Changing the camera's date using the **Time zone and date** option in the setup menu after an image has been captured has no effect on the date printed on the image.



✎ Canceling Existing Print Order



Select **Delete print order** in step 1 of “🖨 Print Order (Creating a DPOF Print Order)” (🔗36) and press the ⏹ button to remove printing marking from all images and cancel the print order.

✎ Print Date

When date and time of recording are imprinted on images using the **Print date** option (🔗55) in the setup menu, images are recorded with shooting date and time imprinted on the image when they are captured. Images with the date imprinted on them can be printed from printers that do not support printing of the date on images.



Only the date and time imprinted on images using the print date option will be printed, even if the date print option is enabled in the **Print order** menu.

Slide Show

Press the  button (playback mode) → MENU button →  Slide show



Play back images stored in the internal memory or on a memory card one by one in an automated “slide show.”

1 Use the multi selector to choose **Start** and press the .

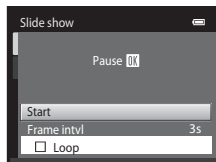
- To change the interval between images, choose **Frame intvl**, select the desired interval time, and press the  button before choosing **Start**.
- To repeat the slide show automatically, choose **Loop** and press the  button before choosing **Start**. The check mark () will be added to the loop option when enabled.





2 The slide show begins.

- While the slide show is in progress, press the multi selector  to display the subsequent image or  to display the previous image. Hold down either button to fast forward or rewind.
- To end or pause slide show, press the .





3 Choose End or Restart.



- The display at right appears when the last slide is displayed or the show is paused. Highlight  and press  to return to Step 1, or select  to restart the show.



Notes About Slide Show

- Only the first frame of movies () included in a slide show is displayed.
- The maximum playback time is about 30 minutes, even if **Loop** is enabled (.



Protect

Press the  button (playback mode) → MENU button →  Protect

Protect selected images from accidental deletion.

Select images to protect or cancel protection for previously protected images from the image selection screen. See “Selecting Images” (42).

Note that formatting the camera’s internal memory or the memory card will permanently delete protected files (60).

Protected images are recognized by the  icon (7) in playback mode.

Selecting Images

The image selection screen like that shown at right is displayed with the following operations:

- Print order>**Select images** (👁️36)
- Protect (🔒41)
- Rotate image (🔄43)
- Copy>**Selected images** (📄46)
- Welcome screen>**Select an image** (👁️49)
- Delete>**Erase selected images** (🗑️33)



Follow the procedures described below to choose the images.

1 Press the multi selector ◀ or ▶ to choose the desired image.

- Rotate the zoom control (📄2) to **T** (🔍) to switch to full-frame playback or **W** (📄) to switch back to 12-thumbnail display.
- Only one image can be selected at a time for **Rotate image** and **Welcome screen**. Proceed to step 3.



2 Press ▲ or ▼ to select or deselect (or to specify the number of copies).



- When an image is selected, a check mark (✔) is displayed with the image. Repeat steps 1 and 2 to select additional images.





3 Press the Ⓞ button to finalize selection.

- When **Selected images** is selected, a confirmation dialog is displayed. Follow the instructions displayed in the monitor.

Rotate Image

Press the  button (playback mode) → MENU button →  Rotate image

Specify the orientation in which recorded images are displayed with playback. Still images can be rotated 90 degrees clockwise or 90 degrees counterclockwise. Images that were recorded in portrait (“tall”) orientation can be rotated up to 180 degrees in either direction.

Select an image in the image selection screen (42). When the rotate image screen is displayed, press the multi selector  or  to rotate the image 90 degrees.

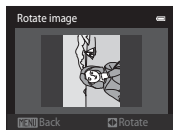

Rotate 90 degrees
counterclockwise

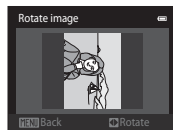



Rotate 90 degrees
clockwise



Press the  button to finalize display orientation, and save orientation data with the image.



Voice Memo

Press the  button (playback mode) → select an image → MENU button →  Voice memo

Use the camera's built-in microphone to record voice memos for images.



- When playing back an image with no voice memo attached, the screen changes to the recording screen. When playing back an image with a voice memo attached (indicated by the  icon in full-frame), the screen changes to the voice memo playback screen.

Recording Voice Memos

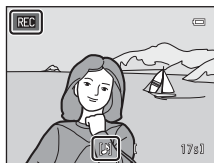
- A voice memo of up to 20 seconds can be recorded while the  button is pressed.
- Do not touch the built-in microphone during recording.
- During recording, **REC** and  flash in the monitor.
- When recording ends, the voice memo playback screen is displayed. See “Playing Voice Memos” for more information.
- Press the multi selector  before or after recording a voice memo to return to the playback menu. Press the **MENU** button to exit the playback menu.







Playing Voice Memos

- Press the  button to play the voice memo.
- Press the  button again to stop playback.
- Rotate the zoom control to **T** or **W** during playback to adjust playback volume.
- Press the multi selector  before or after playing back a voice memo to return to the playback menu. Press the **MENU** button to exit the playback menu.



Deleting Voice Memos

In voice memo playback screen, press the  button. Press the multi selector  or  to choose **Yes** and press the  button. Only the voice memo will be deleted.

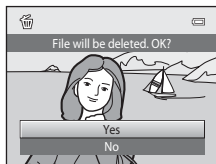



Notes About Voice Memos

- When an image with a voice memo attached is deleted, both the image and its voice memo are deleted.
- Voice memos attached to protected images cannot be deleted.
- If a voice memo already exists for the current image, it must be deleted before a new voice memo can be recorded.
- The COOLPIX S3300 is not able to record a voice memo for images captured with another make or model of digital camera.

More Information

See “Image/Sound File and Folder Names” (70) for more information.

Copy (Copy Between Internal Memory and Memory Card)

Press the  button (playback mode) → MENU button →  Copy

Copy images between the internal memory and a memory card.

1 Use the multi selector to select an option from the copy screen and press the  button.

- **Camera to card:** Copy images from internal memory to memory card.
- **Card to camera:** Copy images from memory card to internal memory.

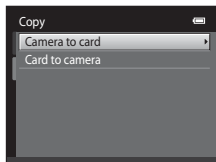



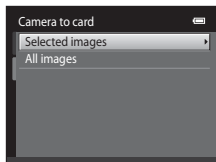

2 Select a copy option and press the  button.

- **Selected images:** Copy images selected from the image selection screen (42).
- **All images:** Copy all images.



Notes About Copying Images

- JPEG-, AVI-, and WAV-format files can be copied. Files recorded in any other format cannot be copied.
- If voice memos (44) are attached to images selected for copying, the voice memos are copied with the images.
- Operation is not guaranteed with images captured with another make of camera or that have been modified on a computer.
- When copying images selected for a **Print order** (36), the print marking is not copied. However, **Protect** (41) settings are copied with images.
- Images or movies copied from the internal memory or a memory card cannot be displayed in auto sort mode (7).
- When images added to albums (4) are copied, the copies are not automatically added to the same albums as the original images.

"Memory contains no images." Message

If a memory card that contains no images is inserted into the camera, **Memory contains no images.** will be displayed when the camera is switched to playback mode. Press the **MENU** button to select **Copy** in the playback menu and copy the images saved in the camera's internal memory to the memory card.

More Information



See "Image/Sound File and Folder Names" (70) for more information.

The Movie Menu

Movie Options

On the shooting screen → MENU button →  tab → Movie options

Select the desired movie option to record. A larger image size improves the image quality and increases the file size.

Option	Description
 HD 720p (1280×720) (default setting*)	Movies with an aspect ratio of 16:9 are recorded.
 VGA (640×480)	Movies with an aspect ratio of 4:3 are recorded.
 QVGA (320×240)	Movies with an aspect ratio of 4:3 are recorded.

* When recording in the internal memory, the default setting is  **VGA (640×480)**.

- The frame rate is approximately 30 frames per second for all options.
- See page 80 for more information about maximum movie length.

More Information

See "Image/Sound File and Folder Names" ( 70) for more information.

Autofocus Mode

On the shooting screen → MENU button →  tab → Autofocus mode

Select the autofocus method used when recording movies.

Option	Description
AF-S Single AF (default setting)	Focus is locked when the  (movie-record) button is pressed to start recording. Select this option when the distance between the camera and the subject will remain fairly consistent.
AF-F Full-time AF	Camera focuses continuously during movie recording. Select this option when the distance between the camera and subject will change significantly during recording. To prevent sound of camera focusing from interfering with recording, use of Single AF is recommended.

Wind Noise Reduction

On the shooting screen → MENU button →  tab → Wind noise reduction

Select whether wind noise is reduced when recording movies.

Option	Description
 On	Records while minimizing the noise of wind blowing on the microphone. Suitable for recording in strong winds. During playback, not only wind noise, but other sounds may also become difficult to hear.
OFF Off (default setting)	Wind noise is not reduced.

When the wind noise reduction setting is enabled, the current setting is displayed during shooting (6). When **Off** is selected, an icon for the current setting is not displayed.

The Setup Menu

Welcome Screen

Press the MENU button → Y tab → Welcome screen

Choose whether or not a welcome screen is displayed when the camera is turned on.

Option	Description
None (default setting)	The camera enters shooting or playback mode without displaying the welcome screen.
COOLPIX	The camera displays a welcome screen and enters shooting or playback mode.
Select an image	<p>Displays an image selected for the welcome screen. When the image selection screen is displayed, select an image (📷42) and press OK button.</p> <ul style="list-style-type: none">As the selected image is stored in the camera, it will be displayed when the camera is turned on even if the original image is deleted.Images captured at an Image mode (📷60) setting of 4608×2592, and copies created at a size of 320 × 240 or smaller using the small picture (📷15) or crop (📷16) function, cannot be used.

Time Zone and Date

Press the MENU button → Y tab → Time zone and date

Set the camera clock.

Option	Description
Date and time	<p>Set camera clock to current date and time. Use the multi selector to set the date and time in the displayed screen.</p> <ul style="list-style-type: none"> • Select a field: Press ◀ or ▶ (the highlight switches between D, M, Y, hour, and minute). • Edit the highlighted field: Press ▲ or ▼. • Apply the settings: Select the minute field and press the OK button.
Date format	<p>Select the order in which the day, month, and year are displayed from Year/Month/Day, Month/Day/Year, and Day/Month/Year.</p>
Time zone	<p>🏠 Home time zone can be specified and daylight saving enabled or disabled from time zone options. When the travel destination (➔) is selected, the camera automatically calculates the time difference between the travel destination and the home time zone (🏠), and saves images using the date and time of the travel destination. Useful when traveling.</p>

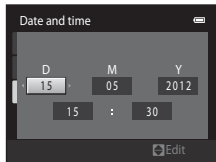

Selecting Travel Destination Time Zone

- 1 Use the multi selector to choose **Time zone** and press the OK button.

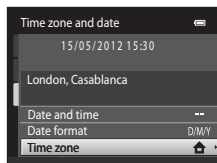

- 2 Choose ➔ **Travel destination** and press the OK button.

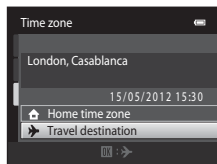

- The date and time displayed in the monitor changes according to the region currently selected.

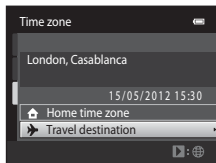

3 Press **▶**.

- The time zone selection screen is displayed.

**4** Press **◀** or **▶** to choose the travel destination time zone.

- Press **▲** in a time zone where daylight saving is in effect to enable the daylight saving time function and automatically advance the time by one hour. The  icon will be displayed at the top of the monitor. Press **▼** to disable the daylight saving time function.
- Press the **OK** button to choose the travel destination time zone.
- While the travel destination time zone is selected, the  icon will be displayed in the monitor when the camera is in shooting mode.

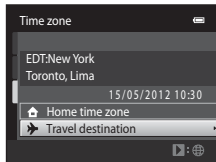
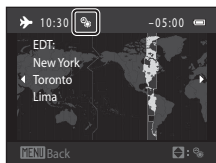
**🔧** **Home Time Zone**

- To switch to the home time zone, choose **Home time zone** in step 2 and press the **OK** button.
- To change the home time zone, choose **Home time zone** in step 2 and perform the same procedure as for **Travel destination** to set the home time zone.

🔧 **Daylight Saving Time**

When daylight saving time starts or ends, turn the daylight saving time function on or off from the time zone selection screen displayed in step 4.

🔧 **Imprinting the Date on Images**

Enable the **Print date** option (55) in the setup menu after the date and time have been set. When the **Print date** option is enabled, images will be recorded with shooting date imprinted on them.

The Setup Menu

Time Zones

The camera supports the time zones listed below. For time zone not listed below, set the camera clock to local time from the **Date and time** option.

UTC +/-	Location	UTC +/-	Location
-11	Midway, Samoa	+1	Madrid, Paris, Berlin
-10	Hawaii, Tahiti	+2	Athens, Helsinki, Ankara
-9	Alaska, Anchorage	+3	Moscow, Nairobi, Riyadh, Kuwait, Manama
-8	PST (PDT): Los Angeles, Seattle, Vancouver	+4	Abu Dhabi, Dubai
-7	MST (MDT): Denver, Phoenix	+5	Islamabad, Karachi
-6	CST (CDT): Chicago, Houston, Mexico City	+5.5	New Delhi
-5	EST (EDT): New York, Toronto, Lima	+6	Colombo, Dhaka
-4.5	Caracas	+7	Bangkok, Jakarta
-4	Manaus	+8	Beijing, Hong Kong, Singapore
-3	Buenos Aires, Sao Paulo	+9	Tokyo, Seoul
-2	Fernando de Noronha	+10	Sydney, Guam
-1	Azores	+11	New Caledonia
±0	London, Casablanca	+12	Auckland, Fiji

Monitor Settings

Press the **MENU** button → **Y** tab → Monitor settings



Set the options below.

Option	Description
Photo info	Choose information displayed in the monitor during shooting and playback mode.
Image review	On (default setting): Image is automatically displayed in the monitor immediately after it is captured and the monitor display returns to shooting mode. Off : Image is not displayed after it is captured.
Brightness	Choose from five settings for monitor brightness. The default setting is 3 .

Photo Info

Select whether or not the photo information is displayed in the monitor.

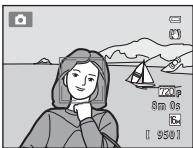
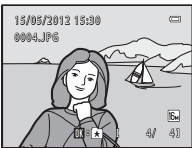
See “The Monitor” (📖6) for information on indicators displayed in the monitor.

	Shooting mode	Playback mode
Show info		
Auto info (default setting)	Current settings and operational guides are displayed as in Show info above. If no operations are performed for a few seconds, the display will be the same as Hide info . Information will be displayed again when the next operation is performed.	
Hide info		

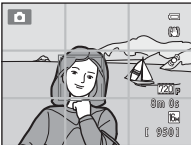
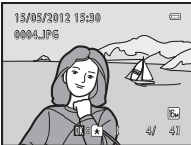
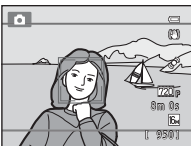
	Shooting mode	Playback mode
<p>Framing grid+auto info</p>	 <p>In addition to information shown with Auto info, a framing grid is displayed as a reference for framing a picture. The grid is not displayed when recording movies.</p>	 <p>The current settings or operational guides are displayed, as in Auto info.</p>
<p>Movie frame+auto info</p>	 <p>In addition to information shown with Auto info, a frame is displayed before recording begins that represents the area that will be captured when recording movies. The frame is not displayed when the shutter release button is pressed halfway or while recording.</p>	<p>The current settings or operational guides are displayed, as in Auto info.</p>

Print Date (Imprinting Date and Time)

Press the **MENU** button → **Y** tab → Print date

The shooting date and time can be imprinted on the images with shooting, allowing the information to be printed even from printers that do not support date printing (📷39).



Option	Description
DATE Date	Date is imprinted on the images.
DATE Date and time	Date and time are imprinted on the images.
OFF Off (default setting)	Date and time are not imprinted on the images.

The current print date setting can be confirmed in the camera monitor with shooting (📖6). When **Off** is selected, no icon is displayed.

✔ Notes About Print Date

- Imprinted dates form a permanent part of image data and cannot be deleted. The date and time cannot be imprinted on images after they have been captured.
- The date cannot be imprinted in the following situations:
 - When using **Panorama assist** scene mode
 - When recording movies
- Dates imprinted at an **Image mode** setting (📖60) of **📷 640×480** may be difficult to read. Choose **📷 1600×1200** or larger when using the **Print date** option.
- The date is recorded using the format selected in the setup menu's **Time zone and date** item (📖22, 📷50).

📝 Print Date and Print Order

If using a DPOF-compatible printer that supports the printing of shooting date and photo information, it is possible to use the **Print order** option (📷36) to print such information even on images that were not captured using the **Print date** option.

Vibration Reduction

Press the **MENU** button → **Y** tab → Vibration reduction

Reduce the effects of camera shake while shooting. Vibration reduction effectively reduces blur, caused by slight hand movement known as camera shake, which commonly occurs when shooting with zoom applied or at slow shutter speeds. The effects of camera shake are reduced when recording movies, in addition to when taking still pictures.

Set **Vibration reduction** to **Off** when using a tripod to stabilize the camera during shooting.

Option	Description
 On (default setting)	Vibration reduction is enabled.
OFF Off	Vibration reduction is disabled.

The current vibration reduction setting is indicated by an icon when shooting (6). No icon is displayed when **Off** is selected.

Notes About Vibration Reduction

- After turning on the camera or after switching from playback mode to shooting mode, wait for the shooting mode screen to be displayed completely before taking pictures.
- Due to characteristics of the vibration reduction function, images displayed in the camera's monitor immediately after shooting may be displayed blurry.
- Vibration reduction may be unable to completely eliminate the effects of camera shake in some situations.

Motion Detection

Press the MENU button → Y tab → Motion detection

Enable motion detection to reduce the effects of subject movement and camera shake when shooting still images.

Option	Description
 Auto (default setting)	<p>When the camera detects subject movement or camera shake, the ISO sensitivity and shutter speed are automatically increased to reduce blurring. However, motion detection does not function in the following situations.</p> <ul style="list-style-type: none"> • When the flash fires. • When Multi-shot 16 (🔗26) is enabled in 📷 (auto) mode. • When ISO sensitivity (🔗28) is set to Fixed range auto, or ISO sensitivity is fixed at a particular value in 📷 (auto) mode. • When AF area mode (🔗30) is set to Subject tracking in 📷 (auto) mode. • When Sports, Night portrait, Dusk/dawn, Night landscape, Museum, Fireworks show, Backlighting, or Pet portrait scene mode is enabled.
OFF Off	Motion detection is not enabled.

The current motion detection setting can be confirmed in the camera monitor with shooting (📖6). The motion detection icon turns green when the camera detects camera shake and increases shutter speed. When **Off** is selected, no icon is displayed.

👍 Notes About Motion Detection

- Motion detection may be unable to completely eliminate the effects of subject movement and camera shake in some situations.
- Motion detection may not function if the subject exhibits significant movement or is too dark.
- The images captured using motion detection may be somewhat “grainy” in appearance.

AF Assist

Press the MENU button → Y tab → AF assist

Enable or disable AF-assist illumination, which assists autofocus operation when the subject is poorly lit.

Option	Description
Auto (default setting)	AF-assist illumination is used to assist the focus operation when the subject is poorly lit. The illuminator has a range of about 1.9 m (6 ft 2 in.) at the maximum wide-angle position and about 1.1 m (3 ft 7 in.) at the maximum telephoto position. Note that for some scene modes such as Museum (📖44) or Pet portrait (🐾46) scene mode, or focus areas, the AF-assist illuminator may not light even when Auto is selected.
Off	AF-assist illuminator does not light up. The camera may be unable to focus under dim lighting.

Digital Zoom

Press the MENU button → Y tab → Digital zoom

Enable or disable digital zoom.

Option	Description
On (default setting)	When the camera is zoomed in to the maximum optical zoom position, rotating the zoom control to T (📷) triggers digital zoom (📖27).
Off	Digital zoom will not be activated (except during movie recording).

👍 Notes About Digital Zoom

- When digital zoom is used, the camera focuses at the center of the frame regardless of the AF area mode setting.
- Digital zoom cannot be used in the following situations.
 - When **Continuous** is set to **Multi-shot 16** (📷26) in 📷 (auto) mode.
 - When **AF area mode** (📷30) is set to **Subject tracking** in 📷 (auto) mode.
 - When **Scene auto selector**, **Portrait**, **Night portrait**, or **Pet portrait** scene mode is selected.
 - When smart portrait mode is selected.

Sound Settings

Press the MENU button →  tab → Sound settings

Adjust the following sound settings.

Option	Description
Button sound	Select On (default setting) or Off . When On is selected, a beep will sound once when operations are completed successfully, twice when the camera acquires focus on the subject, and three times when an error is detected. Start-up sound will also play when the camera is turned on.
Shutter sound	Select On (default setting) or Off . No sound is played with shutter release when some features such as continuous shooting or BSS (Best Shot Selector) are enabled or recording movies, even if On is selected.

Note About Sound Settings



In **Pet portrait** scene mode, button and shutter sounds are disabled.

Auto Off

Press the MENU button →  tab → Auto off

When the camera is on and a period of time passes without any operations having been performed, the monitor will be turned off and the camera will enter standby mode ( 21) to save power. In this option, set the time allowed to elapse before the camera enters standby mode. **30 s**, **1 min** (default setting), **5 min**, and **30 min** can be selected.

When the Monitor Turns off for the Power Saving Function

- Power-on lamp flashes in standby mode.
- Camera turns off after approximately three minutes passes in standby mode.
- To reactivate the monitor while the power on lamp is flashing, press any of the following buttons:
 - Power switch, shutter-release button,  button,  button or  (movie-record) button

Auto Off Settings

- The time allowed to elapse before the camera enters standby mode is fixed in the following situations:
 - When a menu is displayed: three minutes
 - During slide show playback: up to 30 minutes
 - When the AC adapter EH-62G is connected: 30 minutes
- The camera does not enter standby mode when transferring images using an Eye-Fi card.

Format Memory/Format Card

Press the MENU button → Y tab → Format memory/Format card

Use this option to format the internal memory or a memory card.

Formatting the internal memory or memory cards permanently deletes all data. Data that has been deleted cannot be restored. Be sure to transfer important images to a computer before formatting.

Formatting the Internal Memory

To format the internal memory, remove the memory card from the camera. The **Format memory** option is displayed in the setup menu.

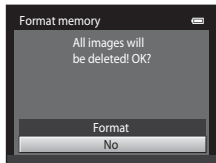

Formatting a Memory Card

A memory card can be formatted when it is inserted in the camera. The **Format card** option is displayed in the setup menu.

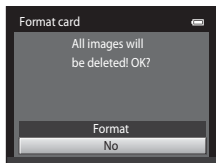

✔ Formatting Internal Memory and Memory Cards

- Formatting the internal memory or memory card restores album icon settings (006) to the default setting (displayed as number).
- Do not turn the camera off, or open the battery-chamber/memory card slot cover during formatting.
- The first time you insert a memory card that has been used in another device into this camera, be sure to format it with this camera.

Language

Press the **MENU** button → **Y** tab → Language

Choose one of 29 languages for display of camera menus and messages.

Čeština	Czech
Dansk	Danish
Deutsch	German
English	(default setting)
Español	Spanish
Ελληνικά	Greek
Français	French
Indonesia	Indonesian
Italiano	Italian
Magyar	Hungarian
Nederlands	Dutch
Norsk	Norwegian
Polski	Polish
Português (BR)	Brazilian Portuguese
Português (PT)	Portuguese

Русский	Russian
Română	Romanian
Suomi	Finnish
Svenska	Swedish
Tiếng Việt	Vietnamese
Türkçe	Turkish
Українська	Ukrainian
عربي	Arabic
简体中文	Simplified Chinese
繁體中文	Traditional Chinese
日本語	Japanese
한글	Korean
ภาษาไทย	Thai
हिन्दी	Hindi

Video Mode

Press the **MENU** button → **Y** tab → Video mode

Adjust settings necessary for connection to a television. Select from **NTSC** and **PAL**.

Charge by Computer

Press the MENU button → Y tab → Charge by computer

Choose whether or not the battery inserted in the camera is charged when the camera is connected to a computer via USB cable.

Option	Description
Auto (default setting)	When the camera is connected to a computer that is running, the battery inserted into the camera is automatically charged using power supplied by the computer.
Off	The battery inserted into the camera is not charged when the camera is connected to a computer.

Notes About Connecting the Camera to a Printer

- The battery cannot be charged with connection to a printer, even if the printer complies with the PictBridge standard.
- When **Auto** is selected for **Charge by computer**, it may be impossible to print images with direct connection of the camera to some printers. If the **PictBridge** startup screen is not displayed in the monitor after the camera is connected to a printer and turned on, turn the camera off and disconnect the USB cable. Set **Charge by computer** to **Off** and reconnect the camera to the printer.

Notes About Charging with Connection to a Computer

- The battery cannot be charged, nor can data be transferred, when the camera is connected to a computer before the camera's display language and date and time have been set (☞22). If the camera's clock battery (☞23) has been exhausted, the date and time must be reset before the battery can be charged or images can be transferred with connection to a computer. In this case, use the Charging AC Adapter EH-69P (☞16) to charge the battery and then set the camera's date and time.
- If the camera is turned off, charging will also stop.
- If a computer enters sleep mode while charging, charging will stop and the camera may turn off.
- When disconnecting the camera from a computer, turn the camera off and then disconnect the USB cable.
- It takes about 2 hours 40 minutes to charge a fully exhausted battery. Charging time increases when images are transferred while the battery is charging.
- When the camera is connected to a computer, an application installed on the computer, such as Nikon Transfer 2, may start. If the camera was connected to the computer for the sole purpose of charging the battery, exit the application.
- The camera turns off automatically if there is no communication with the computer for 30 minutes after the battery has finished charging.
- Depending upon computer specifications, settings, and power supply and allocation, it may be impossible to charge the battery inserted into the camera via computer connection.

Charge Lamp





The following chart explains charge lamp status when the camera is connected to a computer.

Charge lamp	Description
Flashes slowly (green)	Battery charging.
Off	Battery not charging. When the charge lamp changes from slow flashing (green) to off while the power-on lamp is lit, charging is complete.
Flashes quickly (green)	<ul style="list-style-type: none"> The ambient temperature is not suited to charging. Charge the battery indoors with an ambient temperature of 5°C to 35°C (41°F to 95°F). A USB cable is not correctly connected or the battery is faulty. Reconnect the USB cable correctly or replace the battery. Computer is in sleep mode and does not supply power. Reboot the computer. The battery cannot be charged because the computer's specifications or settings do not support power supply to the camera.

Blink Warning

Press the MENU button →  tab → Blink warning

Specify whether or not the camera detects human subjects that have blinked when shooting with face detection (64) in the following modes.

-  (auto) mode (when **Face priority** (30) is selected for AF area mode option).
- **Scene auto selector** (40), **Portrait** (40), or **Night portrait** (41) is selected for the scene mode.

Option	Description
On	When the camera detects that one or more human subjects may have blinked in an image captured using face detection, the Did someone blink? screen is displayed in the monitor. The face of the human subject that may have blinked when the shutter was released is framed by a yellow border. Should this occur, check the image and determine whether or not another image should be captured. See “Operating the Blink Warning Screen” ( 65) for more information.
Off (default setting)	Blink warning is not enabled.

Note About Blink Warning

The blink warning does not function at continuous settings of **Continuous**, **BSS**, or **Multi-shot 16**.

Operating the Blink Warning Screen

When the **Did someone blink?** screen shown on the right is displayed in the monitor, the operations described below are available.



If no operations are performed within a few seconds, the camera automatically returns to shooting mode.



Option	Use	Description
Enlarge the detected face that blinked	T (Q)	Rotate the zoom control to T (Q).
Switch to full-frame playback	W (Q)	Rotate the zoom control to W (Q).
Select the face to be displayed		If the camera detects that more than one human subject blinked, press ◀ or ▶ with display zoomed in to switch to another face.
Delete the image		Press the button.
Switch to shooting mode		Press the button or the shutter-release button.

Eye-Fi Upload

Press the MENU button →  tab → Eye-Fi upload





Option	Description
 Enable	Upload images created by the camera to a preselected destination.
 Disable (default setting)	Images will not be uploaded.

Notes About Eye-Fi Cards

- Note that images will not be uploaded if signal strength is insufficient even if **Enable** is selected.
- Select **Disable** where wireless devices are prohibited.
- Refer to the instruction manual of your Eye-Fi card for more information. In the event of malfunction, contact the card manufacturer.
- The camera can be used to turn Eye-Fi cards on and off, but may not support other Eye-Fi functions.
- The camera is not compatible with the endless memory function. When it is set on a computer, disable the function. If the endless memory function is enabled, the number of pictures taken may not be displayed correctly.
- Eye-Fi cards are for use only in the country of purchase. Observe all local laws concerning wireless devices.
- Leaving the setting as **Enable** will result in the battery being depleted in a shorter period of time.

Eye-Fi communication indicator

The communication status of the Eye-Fi card in the camera can be confirmed on the monitor (.

- : **Eye-Fi upload** is set to **Disable**.
-  (lights): Eye-Fi upload enabled; waiting to begin upload.
-  (flashes): Eye-Fi upload enabled; uploading data.
- : Eye-Fi upload enabled but no images available for upload.
- : An error occurred. The camera cannot control the Eye-Fi card.

Supported Eye-Fi Cards

As of November 2011, the following Eye-Fi cards can be used. Be sure that the Eye-Fi card firmware has been updated to the latest version.

- Eye-Fi Connect X2 SDHC 4GB
- Eye-Fi Mobile X2 SDHC 8GB
- Eye-Fi Pro X2 SDHC 8GB

Reset All

Press the MENU button → Y tab → Reset all

When **Reset** is selected, the camera's settings will be restored to their default values.

Basic Shooting Functions

Option	Default value
Flash mode (📖53)	Auto
Self-timer (📖55)	Off
Macro mode (📖56)	Off
Exposure compensation (📖57)	0.0

Shooting Menu

Option	Default value
Image mode (📖60)	16M 4608×3456
White balance (🔧24)	Auto
Continuous (🔧26)	Single
ISO sensitivity (🔧28)	Auto
Color options (🔧29)	Standard color
AF area mode (🔧30)	Face priority
Autofocus mode (🔧33)	Single AF

Scene Mode

Option	Default value
Scene mode setting in the shooting mode selection menu (📖39)	Scene auto selector
Hue adjustment in Food mode (📖43)	Center
Continuous in pet portrait mode (📖46)	Continuous
Pet portrait auto release in pet portrait mode (📖46)	On

Special Effects Mode

Option	Default value
Special effects mode setting in the shooting mode selection menu (📖47)	Soft

Smart Portrait Menu

Option	Default value
Skin softening (0034)	Normal
Smile timer (0034)	On
Blink proof (0035)	Off

Movie Menu

Option	Default value
Movie options (0047)	When using a memory card: 720p HD 720p (1280x720) When using the internal memory: VGA VGA (640x480)
Autofocus mode (0048)	Single AF
Wind noise reduction (0048)	Off

Setup Menu

Option	Default value
Welcome screen (0049)	None
Photo info (0053)	Auto info
Image review (0053)	On
Brightness (0053)	3
Print date (0055)	Off
Vibration reduction (0056)	On
Motion detection (0057)	Auto
AF assist (0058)	Auto
Digital zoom (0058)	On
Button sound (0059)	On
Shutter sound (0059)	On
Auto off (0059)	1 min
Charge by computer (0062)	Auto
Blink warning (0064)	Off
Eye-Fi upload (0066)	Disable

Others

Option	Default value
Paper size (Fn20, Fn21)	Default
Frame interval for slide show (Fn40)	3 s

- Choosing **Reset all** also clears the current file number (Fn70) from memory. Numbering will continue from the lowest number available. To reset file numbering to "0001", delete all images stored in the internal memory or on the memory card (Fn32) before selecting **Reset all**.
- The following menu settings will remain unaffected when menus are reset with **Reset all**.
Shooting menu: Preset manual data (Fn25) acquired for **White balance**
Setup menu: Image selected for **Welcome screen** (Fn49), **Time zone and date** (Fn50), **Language** (Fn61), and **Video mode** (Fn61)

Firmware Version

Press the MENU button → Y tab → Firmware version

View the current camera firmware version.



Image/Sound File and Folder Names

Images, movies or voice memos are assigned file names as follows.

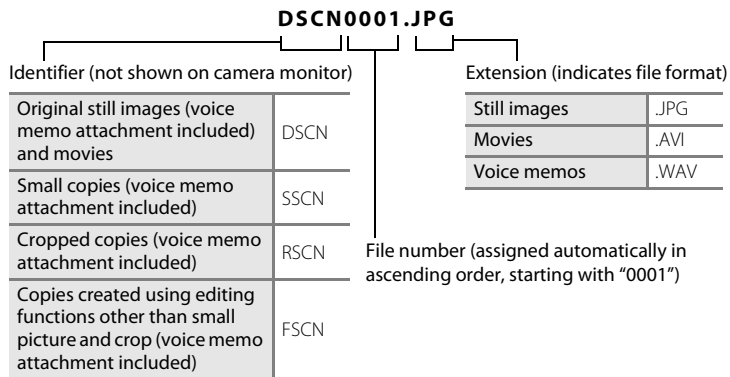

- Files are stored in folders named with a folder number followed by a five-character identifier: "P_" plus a three-digit sequential number for images captured in **Panorama assist** scene mode (e.g. "101P_001"; 2) and "NIKON" for all other images (e.g. "100NIKON"). When the number of files within a folder reaches 9999, a new folder will be created. File numbers will be assigned automatically starting with "0001."
- Voice memo file names have the same identifier and file number as the image to which the voice memo is attached.
- Files copied using **Copy>Selected images** are copied to the current folder, where they are assigned new file numbers in ascending order starting from the largest file number in memory. **Copy>All images** copies all folders from the source medium; file names do not change but new folder numbers are assigned in ascending order, starting from the largest folder number on the destination medium (46).
- A single folder can hold up to 200 files; if the current folder already contains 200 files, a new folder, named by adding one to the current folder name, will be created the next time a file is stored. If the current folder is numbered 999 and contains 200 files, or a file is numbered 9999, no further files can be stored until the internal memory or memory card is formatted (60), or a new memory card is inserted.

Optional Accessories

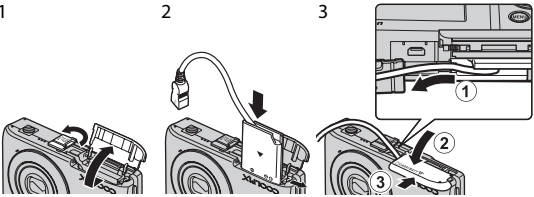



Rechargeable battery	Rechargeable Li-ion Battery EN-EL19 ¹
Charging AC Adapter	Charging AC Adapter EH-69P ^{1,2}
Battery charger	Battery Charger MH-66 (Charging time when no charge remains: Approx. 1 h 50 min)
AC adapter	AC Adapter EH-62G (connect as shown)  Be sure that the power connector cord has been properly aligned in power connector and battery chamber grooves before closing the battery-chamber/memory card slot cover. If part of the cord runs out of the grooves, the cover or cord may be damaged when the cover is closed.
USB cable	USB Cable UC-E6 ¹
Audio/video cable	Audio Video Cable EG-CP14 ¹





¹ Included with the camera at the time of purchase (→  ii).

² When using in other countries, use a plug adapter (available commercially) as necessary.
For more information about plug adapters, consult your travel agency.











Error Messages







The following table lists the error messages and other warnings displayed in the monitor, as well as the solutions for dealing with them.

Display	Cause/Solution	
 (flashes)	Clock not set. Set date and time.	 50
Battery exhausted.	Charge or replace the battery.	14, 16
Battery temperature high	Battery temperature is high. Turn off camera, and allow battery to cool down before resuming use. After five seconds, the monitor will turn off and the power-on lamp will flash rapidly. After the lamps flash for three minutes, the camera will turn off automatically. Pressing the power switch also turns off the camera.	21
The camera will turn off to prevent overheating.	The camera has become hot. The camera turns off automatically. Leave the camera off until it has cooled and then turn it on again.	80
 ● (● flashes red)	Camera cannot focus. <ul style="list-style-type: none"> • Refocus. • Use focus lock. 	26, 29 67
Please wait for the camera to finish recording.	Camera cannot perform other operations until recording is complete. Wait until message clears from display automatically when recording is complete.	–
Memory card is write protected.	Write-protect switch is in “lock” position. Slide write-protect switch to “write” position.	–
Not available if Eye-Fi card is locked.	Write-protect switch of Eye-Fi card is in “lock” position. Slide the write-protect switch to “write” position.	–
	Error accessing Eye-Fi card. <ul style="list-style-type: none"> • Use an approved card. • Check that terminals are clean. • Confirm that Eye-Fi card is correctly inserted. 	 66 18 18
This card cannot be used.	Error accessing memory card. <ul style="list-style-type: none"> • Use approved card. 	19
This card cannot be read.	<ul style="list-style-type: none"> • Check that connectors are clean. 	18
	<ul style="list-style-type: none"> • Confirm that memory card is correctly inserted. 	18

Display	Cause/Solution	
Card is not formatted. Format card? Yes No	Memory card has not been formatted for use in COOLPIX S3300. Formatting deletes all data stored on the memory card. If you need to keep copies of any images, make sure to select No and save the copies to a computer or other medium before formatting the memory card. Select Yes and press the  button to format the memory card.	18
Out of memory.	Memory card is full. <ul style="list-style-type: none"> • Choose smaller image size. • Delete images. • Insert new memory card. • Remove memory card and use internal memory. 	60 32 18 19
Image cannot be saved.	Error occurred while saving image. Format internal memory or memory card.	 60
	Camera has run out of file numbers. Insert a new memory card, or format internal memory or memory card.	 70
	Image cannot be used for welcome screen. The following images cannot be registered as welcome screen. <ul style="list-style-type: none"> • Images captured at an Image mode setting of  4608x2592 • Images reduced to 320 x 240 size or smaller with cropping or small picture editing 	 49
	Insufficient space to save a copy. Delete images from destination.	32
Album is full. No further pictures can be added.	200 images have already been added to album. <ul style="list-style-type: none"> • Remove some images from album. • Add to other albums. 	 5  4
Sound file cannot be saved.	A voice memo cannot be attached to this file. <ul style="list-style-type: none"> • Voice memos cannot be attached to movies. • Select an image captured with COOLPIX S3300. 	–  45
A blink was detected in the picture just taken.	One or more portrait subjects may have blinked when the image was captured. Check the image in playback mode.	30, 51
Image cannot be modified.	Cannot edit selected image. <ul style="list-style-type: none"> • Select images that support editing function. • Movies cannot be edited. 	 11 –
Cannot record movie.	Time out error while recording movie. Choose memory card with faster write speed.	19

Error Messages

Display	Cause/Solution	
Memory contains no images.	No images in the internal memory or memory card. <ul style="list-style-type: none"> To play back images stored in internal memory, remove memory card from the camera. To copy the images saved in the camera's internal memory to the memory card, press the MENU button to select Copy in the playback menu. 	19  46
	The image has not been added to album. <ul style="list-style-type: none"> Add the image to album. Choose the album that the image was added. 	 4  5
	No images are contained in the category selected in auto sort mode. Select the category containing the sorted images.	 7
File contains no image data.	File not created with COOLPIX S3300.	–
This file cannot be played back.	File cannot be viewed on COOLPIX S3300. View file using a computer or the devices used to create or edit this file.	–
All images are hidden.	No images available for a slide show.	 40
This image cannot be deleted.	Image is protected. Disable protection.	 41
Travel destination is in the current time zone.	Destination in same time zone as home.	 50
Lens error	The lens is not working properly. Turn camera off and then on again. If error persists, contact retailer or Nikon-authorized service representative.	20
Communications error	An error occurred during communication with printer. Turn camera off and reconnect USB cable.	 19
System error	An error occurred in camera's internal circuitry. Turn camera off, remove and reinsert battery, and turn camera on. If error persists, contact retailer or Nikon-authorized service representative.	14, 21
Printer error: check printer status.	An error occurred with the printer. Check printer. After solving the problem, select Resume and press the  button to resume printing.*	–
Printer error: check paper	Specified size of paper is not loaded in printer. Load the specified paper, select Resume and press the  button to resume printing.*	–

Display	Cause/Solution	
Printer error: paper jam	Paper has jammed in the printer. Remove the jammed paper, select Resume and press the  button to resume printing.*	–
Printer error: out of paper	No paper is loaded in printer. Load the specified paper, select Resume and press the  button to resume printing.*	–
Printer error: check ink	An error occurred with the ink. Check ink, select Resume and press the  button to resume printing.*	–
Printer error: out of ink	Running out of ink or ink cartridge is empty. Replace ink cartridge, select Resume and press the  button to resume printing.*	–
Printer error: file corrupt	An error occurred with the image file to be printed. Select Cancel and press the  button to cancel printing.	–

* See the documentation provided with your printer for further guidance and information.



A series of horizontal dashed lines spanning the width of the page, intended for handwriting practice.



Technical Notes and Index

Maximizing Camera Life and Performance	2
Memory Cards.....	5
Cleaning.....	6
Storage	6
Troubleshooting	7
Specifications.....	14
Supported Standards.....	17
Index	18

Maximizing Camera Life and Performance

To ensure continued enjoyment of this Nikon product, observe the precautions described below in addition to the warnings in "For Your Safety" (📖vi) when using or storing the device.

The Camera

✔ Keep Dry

The device will be damaged if immersed in water or subjected to high humidity.

✔ Do Not Drop

The product may malfunction if subjected to strong shock or vibration.

✔ Handle the Lens and All Moving Parts with Care

Do not apply force to the lens, lens cover, monitor, memory card slot or battery chamber. These parts are easily damaged. Applying force to the lens cover could result in camera malfunction or damage to the lens. Should the monitor break, care should be taken to avoid injury caused by broken glass and to prevent the liquid crystal from the display touching the skin or entering the eyes or mouth.

✔ Do Not Point the Lens at Strong Light Sources for Extended Periods

Avoid pointing the lens at the sun or other strong light sources for extended periods when using or storing the camera. Intense light may cause deterioration of the CCD image sensor, producing a white blur effect in photographs.

✔ Keep Away from Strong Magnetic Fields

Do not use or store this device in the vicinity of equipment that generates strong electromagnetic radiation or magnetic fields. Strong static charge or the magnetic fields produced by equipment such as radio transmitters could interfere with the monitor, damage data stored on the memory card, or affect the product's internal circuitry.

✔ Avoid Sudden Changes in Temperature

Sudden changes in temperature, such as when entering or leaving a heated building on a cold day, can cause condensation to form inside the device. To prevent condensation, place the device in a carrying case or a plastic bag before exposing it to sudden changes in temperature.

✔ Turn the Product Off Before Removing or Disconnecting the Power Source or Memory Card

Do not remove the battery while the product is on, or while images are being recorded or deleted. Forcibly cutting power in these circumstances could result in loss of data or in damage to product memory or internal circuitry.

 **Notes on the Monitor**

- Monitors and electronic viewfinders are constructed with extremely high precision; at least 99.99% of pixels are effective, with no more than 0.01% being missing or defective. Hence while these displays may contain pixels that are always lit (white, red, blue, or green) or always off (black), this is not a malfunction and has no effect on images recorded with the device.
- White or colored streaks may be visible when bright subjects are framed in the monitor. This phenomenon, known as “smear,” occurs when extremely bright light strikes the image sensor; it is characteristic of image sensors and does not indicate a malfunction. Smear may also take the form of partial discoloration in the monitor during shooting. It does not appear in images recorded with the camera except in the cases of movies and of images recorded with **Multi-shot 16** selected for **Continuous**. When shooting in these modes, we recommend that you avoid bright subjects such as the sun, reflected sunlight, and electric lights.
- Images in the monitor may be difficult to see under bright lighting.
- The monitor is lit by an LED backlight. Should the monitor begin to dim or flicker, contact your Nikon-authorized service representative.

The Battery

- Check the battery level before using the camera and replace or charge the battery if necessary. Do not continue charging once the battery is fully charged as this will result in reduced battery performance. Whenever possible, carry a fully charged spare battery when taking pictures on important occasions.
- Do not use the battery at ambient temperatures below 0°C (32°F) or above 40°C (104°F).
- Charge the battery indoors with an ambient temperature of 5°C to 35°C (41°F to 95°F) before use.
- When charging the battery inserted into the COOLPIX S3300 using the Charging AC Adapter EH-69P or a computer, the battery is not charged at battery temperatures below 0°C (32°F) or above 45°C (113°F).
- Note that the battery may become hot during use; wait for the battery to cool before charging. Failure to observe these precautions could damage the battery, impair its performance, or prevent it from charging normally.
- On cold days, the capacity of batteries tends to decrease. Be sure that the battery is fully charged before heading outside to take pictures in cold weather. Keep spare batteries in a warm place and exchange as necessary. Once warmed, a cold battery may recover some of its charge.
- Dirt on the battery terminals can prevent the camera from functioning. Should the battery terminals become dirty, wipe them off with a clean, dry cloth before use.
- If the battery will not be used for some time, insert it in the camera and completely exhaust it before removing it for storage. The battery should be stored in a cool location with an ambient temperature of 15°C to 25°C (59°F to 77°F). Do not store the battery in hot or extremely cold locations.
- Always remove the battery from the camera or optional battery charger when it is not being used. When inserted, minute amounts of current flow even when unused, and the battery may become excessively drained and no longer function. Turning the camera on or off while the battery is exhausted can result in reduced battery life.
- Recharge the battery at least once every six months and completely exhaust it before returning it to storage.
- After removing the battery from the camera or optional battery charger, put the battery in the battery case and store it in a cool place.
- A marked drop in the time a fully charged battery retains its charge, when used at room temperature, indicates that the battery needs to be replaced. Purchase a new EN-EL19 battery.
- Replace the battery when it no longer holds a charge. Used batteries are a valuable resource. Please recycle used batteries in accordance with local regulations.

Charging AC Adapter

- The Charging AC Adapter EH-69P is for use only with compatible devices. Do not use with another make or model of device.
- The EH-69P is compatible with AC 100-240 V, 50/60 Hz electrical outlets. When using in other countries, use a plug adapter (available commercially) as necessary. For more information about plug adapters, consult your travel agency.
- Do not, under any circumstances, use another make or model of AC adapter other than Charging AC Adapter EH-69P or USB-AC adapter. Failure to observe this precaution could result in overheating or in damage to the camera.

Memory Cards

- Use only Secure Digital memory cards. See “Approved Memory Cards” (📖19) for more information about memory cards.
- Be sure to follow the precautions described in the documentation included with the memory card.
- Do not put labels or stickers on memory cards.
- When you use memory cards that have been used with other devices for the first time, be sure to format them with this camera. We recommend formatting new memory cards with this camera before using them with this camera.
- Note that **formatting permanently deletes all images and other data on the memory card**. Be sure to make copies of any images you wish to keep before formatting the memory card.
- If the message **Card is not formatted. Format card?** is displayed when the camera is turned on, the memory card must be formatted. If there is data that you do not want to delete, select **No**. Copy the necessary data to a computer, etc. If you want to format the card, select **Yes**. The confirmation dialog will be displayed. To start formatting, press the  button.
- Do not perform the following during formatting, while data is being written to or deleted from the memory card, or during data transfer to a computer. Failure to observe this precaution could result in the loss of data or in damage to the camera or memory card:
 - Open the battery-chamber/memory card slot cover to remove/insert the battery or memory card.
 - Turn off the camera.
 - Disconnect the AC adapter.
- Do not format the memory card using a computer.

Cleaning

Lens	Avoid touching the lens with your fingers. Remove dust or lint with a blower (typically a small device with a rubber bulb attached to one end that is pumped to produce a stream of air out the other end). To remove fingerprints or other stains that cannot be removed with a blower, wipe the lens with a soft cloth, using a spiral motion that starts at the center of them and working toward the edges. If this fails, clean the lens using a cloth lightly dampened with commercial lens cleaner.
Monitor	Remove dust or lint with a blower. To remove fingerprints and other stains, clean the monitor with a soft, dry cloth, being careful not to apply pressure.
Body	Use a blower to remove dust, dirt or sand, then wipe gently with a soft, dry cloth. After using the camera at the beach or other sandy or dusty environment, wipe off any sand, dust or salt with a dry cloth lightly dampened with fresh water and dry thoroughly. Note that foreign matter inside the camera could cause damage not covered by the warranty.

Do not use alcohol, thinner, or other volatile chemicals.

Storage

Turn the camera off when not in use. Be sure that the power-on lamp is off before putting the camera away. Remove the battery if the camera will not be used for an extended period. Do not store the camera with naphtha or camphor moth balls, or in any of the following locations:

- Next to equipment that produces strong electromagnetic fields, such as televisions or radios
- Exposed to temperatures below -10°C (14°F) or above 50°C (122°F)
- Places that are poorly ventilated or subject to humidity of over 60%







To prevent mold or mildew, take the camera out of storage at least once a month. Turn the camera on and release the shutter a few times before putting the camera away again.

- For storing the battery, follow the precautions in “The Battery” (🔋4) in “Maximizing Camera Life and Performance.”













Troubleshooting

If the camera fails to function as expected, check the list of common problems below before consulting your retailer or Nikon-authorized service representative.

Display, Settings and Power Supply

Problem	Cause/Solution	
Battery inserted into the camera cannot be charged.	<ul style="list-style-type: none"> • Confirm all connections. • Off is selected for Charge by computer in the setup menu. • When charging by connecting the camera to a computer, battery charging stops when the camera is turned off. • When charging by connecting the camera to a computer, battery charging stops if the computer is suspended (sleeping), and the camera may turn off. • Depending upon computer specifications, settings, and status, it may be impossible to charge the battery inserted into the camera via computer connection. 	16 88,  62 88,  62 88,  62 –
The camera cannot be turned on.	<ul style="list-style-type: none"> • Battery is exhausted. • When connecting to an electrical outlet using a Charging AC Adapter, the camera cannot be turned on. 	20 16
The camera turns off without warning.	<ul style="list-style-type: none"> • Battery is exhausted. • The camera automatically turns off to save power if no operations are performed for an extended period of time. • The camera and battery may not work properly at low temperatures. • The camera turns off if the Charging AC Adapter is connected while the camera is on. • The USB cable connecting the camera to the computer or printer has been disconnected. Reconnect the USB cable. • The internal temperature of the camera or the memory card is high. Leave the camera off until it has cooled and then turn it on again. 	20 21,  59  4 16 72,  19 –

Troubleshooting









Problem	Cause/Solution	
Monitor is blank.	<ul style="list-style-type: none"> The camera is off. Battery is exhausted. Standby mode for saving power. Press the power switch, shutter-release button,  button,  button, or  button. When flash lamp flashes, wait until flash has charged. The camera and computer are connected via USB cable. The camera and TV are connected via audio/video cable. 	21 20 21 53 72, 75 72,  17
Monitor is hard to read.	<ul style="list-style-type: none"> Adjust monitor brightness. Monitor is dirty. Clean monitor. 	86,  53  6
Date and time of recording are not correct.	<ul style="list-style-type: none"> If the camera clock has not been set, "Date not set" indicator flashes with shooting and movie recording. Images and movies recorded before clock is set are dated "00/00/0000 00:00" or "01/01/2012 00:00" respectively. Set the correct time and date from the Time zone and date option in the setup menu. The camera clock is not as accurate as ordinary watches or clocks. Periodically compare the time of the camera clock with that of a more accurate timepieces and reset as required. 	22,  50 23,  50
No indicators displayed in monitor.	Hide info is selected for Photo info in Monitor settings in the setup menu.	86,  53
Print date not available.	The camera clock has not been set.	22, 86,  50
Date not appearing on images even when Print date is enabled.	<ul style="list-style-type: none"> The current shooting mode is one that does not support Print date. The date cannot be imprinted on movies. 	86,  55
Screen for setting time zone and date is displayed when the camera is turned on.	Clock battery is exhausted; all settings were restored to their default values.	22, 23
The camera settings reset.		
Monitor turns off, and the power-on lamp flashes rapidly.	Battery temperature is high. Turn off the camera and allow battery to cool down before resuming use. After the lamp flashes for three minutes, the camera will turn off automatically. Pressing the power switch also turns off the camera.	21

Problem	Cause/Solution	
The camera becomes hot.	The camera may become hot when used for an extended period of time to shoot movies or send images using an Eye-Fi card, or when used in a hot environment; this is not a malfunction.	–













Electronically Controlled Cameras















In extremely rare instances, unusual characters may appear in the monitor and the camera may stop functioning. In most cases, this phenomenon is caused by a strong external static charge. Turn the camera off, remove and reinsert the battery, then turn the camera on again. In the event of continued malfunction, contact your retailer or Nikon-authorized service representative. Note that disconnecting the power source as described above may result in the loss of any data not recorded to internal memory or the memory card at the time the problem occurred. Data already recorded will not be affected.

Shooting

Problem	Cause/Solution	
No image captured when shutter-release button is pressed.	<ul style="list-style-type: none"> When the camera is in playback mode, press the  button, shutter-release button, or  ( movie-record) button. When menus are displayed, press the MENU button. Battery is exhausted. When flash lamp flashes, flash is charging. 	8, 30 10 20 53
The camera cannot focus.	<ul style="list-style-type: none"> The subject is too close to the camera. Try shooting using macro mode, or Scene auto selector or Close-up scene mode. The intended subject is one with which autofocus does not perform well. Select Auto for AF assist in the set up menu. Turn the camera off and then on again. 	40, 43, 56 29 87,  58 21
Images are blurred.	<ul style="list-style-type: none"> Use flash. Increase the ISO sensitivity value. Enable vibration reduction or motion detection. Use BSS. Use a tripod to stabilize the camera when shooting (using the self-timer at the same time is more effective). 	53 37,  28 87,  56,  57 37, 44,  26 55

Troubleshooting







Problem	Cause/Solution	
Streaks of light or partial discoloration are visible in the monitor.	Smear may occur when extremely bright light strikes the image sensor. When shooting with Continuous set to Multi-shot 16 and when recording movies, avoiding bright objects, such as the sun, reflections of the sun, and electric lights is recommended.	 27,  3
Bright specks appear in images captured with flash.	Flash is reflecting off particles in air. Set the flash mode setting to  (Off).	54
Flash does not fire.	<ul style="list-style-type: none"> • The flash mode is set to  (Off). • Some scene modes with which the flash does not function are selected. • On is selected for Blink proof in smart portrait menu. • Another function that restricts flash is enabled. 	54 59 51 62
Optical zoom cannot be used.	Optical zoom cannot be used while recording movies.	79
Digital zoom cannot be used.	<ul style="list-style-type: none"> • Digital zoom is set to Off in the setup menu. • Digital zoom is not available in the following situations. <ul style="list-style-type: none"> - When Continuous is set to Multi-shot 16 in  (auto) mode. - When AF area mode is set to Subject tracking in  (auto) mode. - When Scene auto selector, Portrait, Night portrait, or Pet portrait scene mode is selected. - When shooting in smart portrait mode. 	87,  58 37,  26 38,  30 40, 41, 46 49
Image mode not available.	Another function that restricts the Image mode option is enabled.	60
No sound when shutter is released.	<ul style="list-style-type: none"> • Off is selected for Sound settings>Shutter sound in the setup menu. No sound is produced with some shooting modes and settings, even when On is selected. • The speaker is blocked. Do not cover the speaker. 	87,  59 3, 26
AF-assist illuminator does not light up.	Off is selected for AF assist in the setup menu. AF-assist illuminator may not light depending on the position of the focus area or the current scene mode, even when Auto is selected.	87,  58









Problem	Cause/Solution	
Images appear smeared.	Lens is dirty. Clean lens.	 :6
Colors are unnatural.	White balance does not match light source.	37, 43,  24
Randomly spaced bright pixels ("noise") appear in image.	Shutter speed is too slow or ISO sensitivity is high as the subject is dark. Noise can be reduced by: <ul style="list-style-type: none"> • Using flash. • Specifying a lower ISO sensitivity setting. 	53 37,  28
Randomly spaced bright pixels ("noise") appear in movies.	When recording movies in dim lighting, the image may become somewhat "grainy" in appearance. This occurs when the ISO sensitivity increases, and it does not indicate a malfunction.	–
Images are too dark (underexposed).	<ul style="list-style-type: none"> • The flash mode is set to  (Off). • Flash window is blocked. • Subject is beyond flash range. • Adjust exposure compensation. • Increase ISO sensitivity. • Subject is backlit. Select Backlighting scene mode or set the flash mode setting to  (Fill flash). 	54 26 53 57 37,  28 44, 54
Images are too bright (overexposed).	Adjust exposure compensation.	57
Unexpected results when flash set to  (Auto with red-eye reduction).	When taking pictures with  (Auto with red-eye reduction) or fill flash with slow sync and red-eye reduction in Night portrait scene mode, In-Camera Red Eye Fix may be applied to areas not affected by red-eye. Use any scene mode other than Night portrait , and change the flash mode to any setting other than  (Auto with red-eye reduction) and try shooting again.	41, 54
Skin tones are not softened.	<ul style="list-style-type: none"> • Under some shooting conditions, facial skin tones may not be softened. • Use  (Skin softening) for Glamour retouch in the playback menu for images containing more than three faces. 	66,  34 66,  13
Saving images takes time.	It may take more time to save images in the following situations. <ul style="list-style-type: none"> • When the noise reduction function is in operation. • When the flash mode is set to  (Auto with red-eye reduction). • When the skin softening function is applied while shooting. 	– 54 40, 41, 66,  34

Troubleshooting

Problem	Cause/Solution	
Colored circles or light streaks appear in the monitor or images.	When shooting with backlighting or when a very strong light source (such as sunlight) is in the frame, colored circles or light streaks (ghosting) may occur. Change the position of the light source, or frame the picture so that the light source does not enter the frame and try again.	–

Playback

Problem	Cause/Solution	
File cannot be played back.	<ul style="list-style-type: none"> File or folder was overwritten or renamed by computer or other make of the camera. Movies recorded by a camera other than the COOLPIX S3300 cannot be played back. 	– 82
Cannot zoom in on image.	<ul style="list-style-type: none"> Images captured with cameras other than COOLPIX S3300 may not be enlarged. Playback zoom cannot be used with movies, small pictures, or images that have been cropped to a size of 320 × 240 or smaller. 	–
Cannot record or play back voice memos.	<ul style="list-style-type: none"> Voice memos cannot be attached to movies. Voice memos cannot be attached to images captured with other cameras. Voice memos attached to images using another camera cannot be played back on this camera. 	– 71,  44
Cannot edit images.	<ul style="list-style-type: none"> These options cannot be used with movies. These options cannot be used with images captured at an Image mode setting of  4608×2592. Select images that support editing functions. The camera is unable to edit images captured with other cameras. 	– 60 71,  11  10
Images not displayed on television.	<ul style="list-style-type: none"> Select correct Video mode. Memory card contains no images. Replace the memory card. Remove the memory card to play back images from the internal memory. 	88,  61 18
Album icon restored to default settings, or images added to album not displayed in favorite pictures mode.	Data in the memory card may not be played back correctly if overwritten by a computer.	–

Problem	Cause/Solution	
The recorded images are not displayed in auto sort mode.	<ul style="list-style-type: none"> The desired image was sorted into a category other than the category currently displayed. Images recorded by a camera other than the COOLPIX S3300 and images copied using the copy option cannot be displayed in auto sort mode. Images recorded in internal memory or on the memory card may not be played back correctly if overwritten by a computer. Up to 999 images or movie files can be added to each category. If the desired category already contains 999 images, new images or movies cannot be added. 	70,  70,  ,  46 – 70, 
Nikon Transfer 2 does not start when the camera is connected to a computer.	<ul style="list-style-type: none"> The camera is off. Battery is exhausted. USB cable is not properly connected. The camera is not recognized by the computer. Confirm system requirements. Computer is not set to start Nikon Transfer 2 automatically. For more information on Nikon Transfer 2, refer to help information contained in ViewNX 2. 	21 20 72 – 73 73
The PictBridge startup screen is not displayed when the camera is connected to a printer.	With some PictBridge-compatible printers, the PictBridge startup screen may not be displayed and it may be impossible to print images when Auto is selected for the Charge by computer option in the setup menu. Set the Charge by computer option to Off and reconnect the camera to the printer.	72,  62
Images to be printed are not displayed.	<ul style="list-style-type: none"> Memory card contains no images. Replace the memory card. Remove the memory card to print images from the internal memory. 	18
Cannot select paper size with the camera.	Paper size cannot be selected from the camera in the following situations, even when printing from a PictBridge-compatible printer. Select paper size from the printer. <ul style="list-style-type: none"> The printer does not support the paper size specified by the camera. The printer automatically selects the paper size. 	72,  , 20,  21 –

Specifications

Nikon COOLPIX S3300 Digital Camera

Type	Compact digital camera
Effective pixels	16.0 million
Image sensor	¹ /2.3-in. type CCD; total pixels: approx. 16.44 million
Lens	6× optical zoom, NIKKOR lens
Focal length	4.6–27.6mm (angle of view equivalent to that of 26–156 mm lens in 35mm [135] format)
f/-number	f/3.5–6.5
Construction	5 elements in 5 groups
Digital zoom	Up to 4× (angle of view equivalent to that of approx. 624 mm lens in 35mm [135] format)
Vibration reduction	Lens shift
Autofocus (AF)	Contrast-detect AF
Focus range (from lens)	<ul style="list-style-type: none">• [W]: Approx. 50 cm (1 ft 8 in.) to ∞, [T]: Approx. 1.0 m (3 ft 4 in.) to ∞• Macro mode: Approx. 5 cm (2 in.) (wide-angle position) to ∞
Focus-area selection	Face priority, auto (9-area automatic selection), center, manual with 99 focus areas, subject tracking
Monitor	6.7-cm (2.7-in.), approx. 230k-dot, TFT LCD with anti-reflection coating, and 5-level brightness adjustment
Frame coverage (shooting mode)	Approx. 98% horizontal and 98% vertical (compared to actual image)
Frame coverage (playback mode)	Approx. 100% horizontal and 100% vertical (compared to actual image)
Storage	
Media	<ul style="list-style-type: none">• Internal memory (approx. 42 MB)• SD/SDHC/SDXC memory card
File system	DCF, Exif 2.3, and DPOF compliant
File formats	Still images: JPEG Sound files (Voice Memo): WAV Movies: AVI (Motion-JPEG compliant)
Image size (pixels)	<ul style="list-style-type: none">• 16M (high image quality) [4608 × 3456★]• 16M [4608 × 3456]• 8M [3264 × 2448]• 4M [2272 × 1704]• 2M [1600 × 1200]• VGA [640 × 480]• 16:9 [4608 × 2592]

ISO sensitivity (Standard output sensitivity)	<ul style="list-style-type: none"> • ISO 80, 100, 200, 400, 800, 1600, 3200 • Auto (auto gain from ISO 80 to 1600) • Fixed range auto (ISO 80 to 400, 80 to 800)
Exposure	
Metering	256-segment matrix, center-weighted (digital zoom less than 2x), spot (digital zoom 2x or more)
Exposure control	Programmed auto exposure with motion detection and exposure compensation (-2.0 to +2.0 EV in steps of $\frac{1}{3}$ EV)
Shutter	Mechanical and charge-coupled electronic shutter
Speed	$\frac{1}{2000}$ –1 s 4 s (when scene mode is set to Fireworks show)
Aperture	Electronically-controlled ND filter (-3.3 AV) selection
Range	2 steps (f/3.5 and f/11.5 [W])
Self-timer	Can be selected from 10 and 2 second durations
Built-in flash	
Range (approx.) (ISO sensitivity: Auto)	[W]: 0.5 to 4.5 m (1 ft 8 in. to 14 ft) [T]: 0.5 to 2.4 m (1 ft 8 in. to 7 ft 10 in.)
Flash control	TTL auto flash with monitor preflashes
Interface	Hi-Speed USB
Data Transfer Protocol	MTP, PTP
Video output	Can be selected from NTSC and PAL
I/O terminal	Audio/video (A/V) output; digital I/O (USB)
Supported languages	Arabic, Chinese (Simplified and Traditional), Czech, Danish, Dutch, English, Finnish, French, German, Greek, Hindi, Hungarian, Indonesian, Italian, Japanese, Korean, Norwegian, Polish, Portuguese (European and Brazilian), Romanian, Russian, Spanish, Swedish, Thai, Turkish, Ukrainian, Vietnamese
Power sources	One Rechargeable Li-ion Battery EN-EL19 (included) AC Adapter EH-62G (available separately)
Charging time	Approx. 2 h 30 min (when using Charging AC Adapter EH-69P and when no charge remains)
Battery life (EN-EL19)	Still images*: Approx. 210 shots Movies: Approx. 1 h 30 min (HD 720p (1280x720) , the maximum file size for a single movie is 2 GB or the maximum recording time for a single movie is 29 minutes, even when there is sufficient free space on the memory card for longer recording.)
Tripod socket	1/4 (ISO 1222)
Dimensions (W x H x D)	Approx. 94.8 x 57.8 x 19.5 mm (3.8 x 2.3 x 0.8 in.) (excluding projections)

Specifications

Weight	Approx. 128 g (4.6 oz) (with battery and SD memory card)
Operating environment	
Temperature	0°C to 40°C (32°F to 104°F)
Humidity	Less than 85% (no condensation)

- Unless otherwise stated, all figures are for a camera with a fully-charged Rechargeable Li-ion Battery EN-EL19 operated at an ambient temperature of 25°C (77°F).

* Based on Camera and Imaging Products Association (CIPA) standards for measuring the life of camera batteries. Measured at 23 (±2) °C (73 (±4) °F); zoom adjusted with each shot, flash fired with every other shot, image mode set to  **4608x3456**. Battery life may vary depending on shooting interval and length of time menus and images are displayed.

Rechargeable Li-ion Battery EN-EL19

Type	Rechargeable lithium-ion battery
Rated capacity	DC 3.7 V, 700 mAh
Operating temperature	0°C to 40°C (32°F to 104°F)
Dimensions (W × H × D)	Approx. 31.5 × 39.5 × 6 mm (1.3 × 1.6 × 0.3 in.) (excluding projections)
Weight	Approx. 14.5 g (0.5 oz) (excluding battery case)

Charging AC Adapter EH-69P

Rated input	AC 100–240 V, 50/60 Hz, 0.068–0.042 A
Rated output	DC 5.0 V, 550 mA
Operating temperature	0°C to 40°C (32°F to 104°F)
Dimensions (W × H × D)	Approx. 55 × 22 × 54 mm (2.2 × 0.9 × 2.2 in.) (excluding plug adapter) For Argentina: Approx. 55 × 59 × 63 mm (2.2 × 2.4 × 2.5 in.) For Korea: Approx. 55 × 59 × 66.5 mm (2.2 × 2.4 × 2.7 in.)
Weight	Approx. 55 g (2.0 oz) (excluding plug adapter) For Argentina and Korea: Approx. 80 g (2.9 oz)

Specifications

- Nikon will not be held liable for any errors this manual may contain.
- The appearance of this product and its specifications are subject to change without notice.

Supported Standards































- **DCF:** Design Rule for Camera File System is a standard widely used in the digital camera industry to ensure compatibility among different makes of camera.
- **DPOF:** Digital Print Order Format is an industry-wide standard that allows images to be printed from print orders stored on memory cards.
- **Exif version 2.3:** This camera supports Exchangeable image file format (Exif) version 2.3 for digital still cameras, a standard that allows information stored with photographs to be used for optimal color reproduction when images are output from Exif-compliant printers.
- **PictBridge:** A standard developed cooperatively by the digital camera and printer industries, allowing photographs to be output directly to a printer without connecting the camera to a computer.

Index

Symbols

Auto mode 20, 24, 36
 Scene mode 39
 Special effects mode 47
 Smart portrait mode 49
 Playback mode 30, 70
 Favorite pictures mode 70,
 Auto sort 70,
 List by date 70,
 Setup menu 86
T (Telephoto) 2, 27
W (Wide-angle) 2, 27
 Playback zoom 2, 31
 Thumbnail playback 2, 31
 Help 2, 39
 (movie-record) button 3, 4, 5, 78
 (Shooting mode) button 3, 4, 5, 8, 24
 Playback button 3, 4, 5, 8, 30
 Apply selection button 3, 5, 9
MENU Menu button 3, 4, 5, 10, 37, 71, 81, 86
 Delete button 3, 4, 5, 32, 83,
 Flash mode 53
 Self timer 55
 Macro mode 56
 Exposure compensation 57
AE/AF-L
A
AC adapter 17,
Adding favorite pictures
Advanced red-eye reduction 54
AF area mode 38,
AF assist 87,
Album

Aperture value 28
Audio/video cable 72,
Auto flash 54
Auto mode 36
Auto off 87,
Auto sort menu 71,
Auto sort mode 70,
Autofocus 38, 56, 81,
Autofocus mode 38, 81,
AVI
B
Backlighting 44
Battery 14, 16, 23,
Battery chamber 3
Battery charger 17,
Battery latch 3, 14
Battery level 20
Battery-chamber/memory card slot cover 3, 14, 18
Beach 41
Best Shot Selector 44,
Black and white copy 44
Black-and-white
Blink proof 51,
Blink warning 88,
Brightness
BSS 37, 44,
Built-in microphone 2
Button sound 87,
C
Calendar Display 31
Charge by computer 88,
Charge lamp 3, 17,
Charging AC Adapter 16,
Close-up 43
Cloudy
Color options 38,

- Compression ratio 60
- Connector cover 3
- Continuous 37, 26
- Copying pictures 71, 46
- Crop 31, 16
- Cross screen 71, 14
- Cyanotype 38, 29
- D**
- Date and time 22, 50
- Date format 22, 50
- Daylight 24
- Daylight saving time 23, 86, 51
- Delete 32, 83, 45
- Digital zoom 27, 87, 58
- Direct print 72, 18
- D-Lighting 71, 12
- DPOF 17
- DPOF printing 23
- DSCN 70
- Dusk/dawn 42
- E**
- Editing images 10
- EH-69P ii, 16
- EN-EL19 ii, 14, 16, 71
- Exposure compensation 57
- Extension 70
- Eye-Fi upload 88, 66
- Eyelet for camera strap 2
- E**
- Face detection 26, 64
- Face priority 38, 30
- Favorite pictures menu 71, 5
- Favorite pictures mode 70, 4
- File names 70
- Fill flash 54
- Filter effects 71, 14
- Fireworks show 44
- Firmware version 88, 69
- Fisheye 71, 14
- Fixed range auto 28
- Flash 53
- Flash lamp 53
- Flash mode 53, 54
- Flash off 54
- Focus 28, 38, 30
- Focus area 28
- Focus indicator 6, 28
- Focus lock 67
- Folder names 70
- Food 43
- Format 18, 88, 60
- Format memory 88, 60
- Format memory card 18, 88, 60
- FSCN 70
- Full-frame playback 30
- Full-time AF 38, 81, 33, 48
- G**
- Glamour retouch 71, 13
- H**
- HD 720p 81, 47
- Help 39
- High key 47
- High-contrast monochrome 47
- I**
- Identifier 70
- Image mode 60, 61
- Image review 53
- Imprinting date and time 23, 39, 55
- Internal memory 19
- Internal memory indicator 6, 20, 78
- ISO sensitivity 37, 28
- J**
- JPG 70
- L**
- Landscape 40

Index

Language 88, 61

Lens 2, 14

Lens cover 2

List by date menu 71, 09

List by date mode 70, 09

Low key LO 47

M

Macro mode 56

Memory card 18, 19

Memory card slot 3, 18

Miniature effect 71, 14

Monitor 3, 6, 6

Monitor settings 86, 53

Motion detection 87, 57

Movie length 78, 80

Movie menu 81, 47

Movie options 81, 47

Movie playback 82

Movie recording 78

Multi selector 3, 4, 5, 9

Multi-shot 16 37, 26

Museum  44

N

Night landscape  42

Night portrait * 41

Nikon Transfer 2 74, 76

Nostalgic sepia SE 47

Number of exposures remaining 20, 61

Q

Optional accessories 71

P

Panorama assist  45, 02

Panorama Maker 6 45, 03



Paper size 20, 21

Party/indoor  41

Pet portrait auto release 46

Pet portrait  46

Photo info 53

PictBridge 72, 18, 17

Playback 30, 82, 44

Playback menu 71, 36

Playback mode 8, 30, 70

Playback zoom 31



Portrait  40



Power 20, 21, 22

Power switch 2, 20, 21

Power-on lamp 2, 20, 21

Preset manual 25

Print 71, 72, 20, 21

Print date 23, 86, 37, 39, 55

Print order 71, 36

Printer 72, 18

Protect settings 71, 41

Q

Quick retouch 71, 12

QVGA 81, 47

R

Rechargeable battery 71

Rechargeable Li-ion battery 14, 16, 71

Red-eye reduction 54

Remaining recording time 80

Removing favorite pictures 05

Reset all 88, 67

Rotate image 71, 43

RSCN 70

S

Scene auto selector SE 40

Scene mode 39, 40

Selective color  47





























Self-timer 55

Self-timer lamp 2, 50, 55











Sepia 38, 29

Setup menu 86, 49

Shooting 24, 26, 28

Shooting menu 37, 24
 Shooting mode 8, 24
 Shutter sound 87, 59
 Shutter speed 28
 Shutter-release button 2, 4, 5, 28
 Single 37, 26
 Single AF 38, 81, 33, 48
 Skin softening 51, 66, 34
 Slide show 71, 40
 Slow sync 54
 Small picture 71, 15
 Smart portrait menu 51, 34
 Smart portrait mode 49
 Smile timer 51, 34
 Snow  42
 Soft 71, 14
 Soft  47
 Sound settings 87, 59
 Speaker 3
 Special effects mode 47
 Sports  41
 SSCN 70
 Standard color 38, 29
 Strap ii, 11
 Subject tracking 38, 31, 32
 Sunset  42
I
 Telephoto 27
 Televisions 72, 17
 Thumbnail display 31
 Time zone 86, 50, 52
 Time zone and date 22, 86, 50
 Tripod socket 3, 15
U
 USB cable 72, 19
 USB/audio/video output connector 3,
 72, 17, 19

V

VGA 81, 47
 Vibration reduction 87, 56
 Video mode 88, 61
 Video-in jack/audio-in jack 17
 ViewNX 2 73
 Vivid color 38, 29
 Voice memo 71, 44
 Volume 82, 44
W
 WAV 70
 Welcome screen 86, 49
 White balance 37, 24
 Wide-angle 27
 Wind noise reduction 6, 81, 48

Z

Zoom control 2, 4, 5, 27, 82
 Zoom in 27
 Zoom out 27



A series of horizontal dashed lines spanning the width of the page, intended for handwriting practice.

Nikon

No reproduction in any form of this manual, in whole or in part (except for brief quotation in critical articles or reviews), may be made without written authorization from NIKON CORPORATION.



NIKON CORPORATION

© 2012 Nikon Corporation

YP2A01(11)
6MM23211-01