

**Nikon**

DIGITAL CAMERA

# COOLPIX S6100

## User's Manual

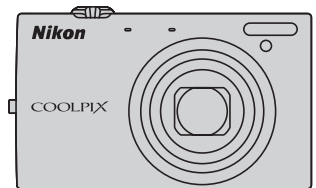

En

### **Trademark Information**

- Microsoft, Windows and Windows Vista are either registered trademarks or trademarks of Microsoft Corporation in the United States and/or other countries.
- Macintosh, Mac OS, and QuickTime are trademarks of Apple Inc., registered in the U.S. and other countries.
- Adobe and Acrobat are registered trademarks of Adobe Systems Inc.
- SDXC, SDHC and SD Logos are trademarks of SD-3C, LLC.
- PictBridge is a trademark.
- HDMI, **HDMI** logo and High-Definition Multimedia Interface are trademarks or registered trademarks of HDMI Licensing LLC.
- All other trade names mentioned in this manual or the other documentation provided with your Nikon product are trademarks or registered trademarks of their respective holders.

### **AVC Patent Portfolio License**

This product is licensed under the AVC Patent Portfolio License for the personal and non-commercial use of a consumer to (i) encode video in compliance with the AVC standard ("AVC video") and/or (ii) decode AVC video that was encoded by a consumer engaged in a personal and non-commercial activity and/or was obtained from a video provider licensed to provide AVC video. No license is granted or shall be implied for any other use. Additional information may be obtained from MPEG LA, L.L.C.

See <http://www.mpegla.com>.

**Introduction**

**First Steps**

**Basic Photography and Playback: 📷 (Auto) Mode**

**More on Shooting**

**More on Playback**

**Editing Images**

**Movie Recording and Playback**

**Connecting to Televisions, Computers and Printers**

**Basic Camera Setup**

**Caring for the Camera**

**Technical Notes and Index**

## For Your Safety

To prevent damage to your Nikon product or injury to yourself or to others, read the following safety precautions in their entirety before using this equipment. Keep these safety instructions where all those who use the product will read them.



This icon marks warnings, information that should be read before using this Nikon product, to prevent possible injury.

### WARNINGS

#### **Turn off in the event of malfunction**

Should you notice smoke or an unusual smell coming from the camera or Charging AC Adapter, unplug the Charging AC Adapter and remove the battery immediately, taking care to avoid burns. Continued operation could result in injury. After removing or disconnecting the power source, take the equipment to a Nikon-authorized service representative for inspection.

#### **Do not disassemble**

Touching the internal parts of the camera or Charging AC Adapter could result in injury. Repairs should be performed only by qualified technicians. Should the camera or Charging AC Adapter break open as the result of a fall or other accident, take the product to a Nikon-authorized service representative for inspection, after unplugging the product and/or removing the battery.

#### **Do not use the camera or Charging AC Adapter in the presence of flammable gas**

Do not use electronic equipment in the presence of flammable gas, as this could result in explosion or fire.

#### **Handle the camera strap with care**

Never place the strap around the neck of an infant or child.

#### **Keep out of reach of children**

Particular care should be taken to prevent infants from putting the battery or other small parts into their mouths.

### **Observe caution when handling the battery**

The battery may leak, overheat, or explode if improperly handled.

Observe the following precautions when handling the battery for use in this product:

- Before replacing the battery, turn the product off. If you are using the Charging AC Adapter/AC adapter, be sure it is unplugged.
- Use only a Rechargeable Li-ion Battery EN-EL12 (supplied). Charge the battery by using a camera that supports battery charging or by using a Battery Charger MH-65 (available separately). To charge the battery with the camera, use either Charging AC Adapter EH-69P (supplied) or the **Charge by computer** function.
- When inserting the battery, do not attempt to insert it upside down or backwards.
- Do not short or disassemble the battery or attempt to remove or break the battery insulation or casing.
- Do not expose the battery to flame or to excessive heat.
- Do not immerse in or expose to water.
- Replace the terminal cover when transporting the battery. Do not transport or store with metal objects such as necklaces or hairpins.
- The battery is prone to leakage when fully discharged. To avoid damage to the product, be sure to remove the battery when no charge remains.
- Discontinue use immediately should you notice any change in the battery, such as discoloration or deformation.

### **Observe the following precautions when handling the Charging AC Adapter**

- If liquid from the damaged battery comes in contact with clothing or skin, rinse immediately with plenty of water.
- Keep dry. Failure to observe this precaution could result in fire or electric shock.
- Dust on or near the metal parts of the plug should be removed with a dry cloth. Continued use could result in fire.
- Do not handle the plug or go near the Charging AC Adapter during lightning storms. Failure to observe this precaution could result in electric shock.
- Do not damage, modify, forcibly tug or bend the USB cable, place it under heavy objects, or expose it to heat or flames. Should the insulation be damaged and the wires become exposed, take it to a Nikon-authorized service representative for inspection. Failure to observe these precautions could result in fire or electric shock.
- Do not handle the plug or Charging AC Adapter with wet hands. Failure to observe this precaution could result in electric shock.
- Do not use with travel converters or adapters designed to convert from one voltage to another or with DC-to-AC inverters. Failure to observe this precaution could damage the product or cause overheating or fire.

 **Use appropriate cables**

When connecting cables to the input and output jacks, use only the cables provided or sold by Nikon for the purpose, to maintain compliance with product regulations.

 **Handle moving parts with care**

Be careful that your fingers or other objects are not pinched by the lens cover or other moving parts.

 **CD-ROMs**

The CD-ROMs supplied with this device should not be played back on audio CD equipment. Playing CD-ROMs on an audio CD player could cause hearing loss or damage the equipment.

 **Observe caution when using the flash**

Using the flash close to your subject's eyes could cause temporary visual impairment. Particular care should be observed if photographing infants, when the flash should be no less than 1 m (3 ft. 4 in.) from the subject.

 **Do not operate the flash with the flash window touching a person or object**

Failure to observe this precaution could result in burns or fire.

 **Avoid contact with liquid crystal**

Should the monitor break, care should be taken to avoid injury caused by broken glass and to prevent liquid crystal from the monitor touching the skin or entering the eyes or mouth.

 **Turn the power off when using inside an airplane or the hospital**

Turn the power off while inside the airplane during take off or landing. Follow the instructions of the hospital when using while in a hospital. The electromagnetic waves given out by this camera may disrupt the electronic systems of the airplane or the instruments of the hospital.

# Notices

## Notices for Customers in the U.S.A.

### **IMPORTANT SAFETY INSTRUCTIONS - SAVE THESE INSTRUCTIONS.**

### **DANGER - TO REDUCE THE RISK OF FIRE OR ELECTRIC SHOCK, CAREFULLY FOLLOW THESE INSTRUCTIONS**

For connection to a supply not in the U.S.A., use an attachment plug adapter of the proper configuration for the power outlet if needed.

The power supply unit is intended to be correctly orientated in a vertical or floor mount position.

### **Federal Communications Commission (FCC) Radio Frequency Interference Statement**

This equipment has been tested and found to comply with the limits for a Class B digital device, pursuant to Part 15 of the FCC rules. These limits are designed to provide reasonable protection against harmful interference in a residential installation. This equipment generates, uses, and can radiate radio frequency energy and, if not installed and used in accordance with the instructions, may cause harmful interference to radio communications. However, there is no guarantee that interference will not occur in a particular installation. If this

equipment does cause harmful interference to radio or television reception, which can be determined by turning the equipment off and on, the user is encouraged to try to correct the interference by one or more of the following measures:

- Reorient or relocate the receiving antenna.
- Increase the separation between the equipment and receiver.
- Connect the equipment into an outlet on a circuit different from that to which the receiver is connected.
- Consult the dealer or an experienced radio/television technician for help.



**Nikon**

**COOLPIX S6100**

### **CAUTIONS**

#### **Modifications**

The FCC requires the user to be notified that any changes or modifications made to this device that are not expressly approved by Nikon Corporation may void the user's authority to operate the equipment.

#### **Interface Cables**

Use the interface cables sold or provided by Nikon for your equipment. Using other interface cables may exceed the limits of Class B Part 15 of the FCC rules.

## **Notice for customers in the State of California**

### **WARNING**

Handling the cord on this product will expose you to lead, a chemical known to the State of California to cause birth defects or other reproductive harm.

#### ***Wash hands after handling.***

Nikon Inc.,

1300 Walt Whitman Road  
Melville, New York 11747-3064  
USA

Tel: 631-547-4200

## **Notice for customers in Canada**

### **CAUTION**

This Class B digital apparatus complies with Canadian ICES-003.

### **ATTENTION**

Cet appareil numérique de la classe B est conforme à la norme NMB-003 du Canada.

## **Notices for customers in Europe**

### **CAUTIONS**

#### **RISK OF EXPLOSION IF BATTERY IS REPLACED BY AN INCORRECT TYPE.**

#### **DISPOSE OF USED BATTERIES ACCORDING TO THE INSTRUCTIONS.**

This symbol indicates that this product is to be collected separately.



The following apply only to users in European countries:

- This product is designated for separate collection at an appropriate collection point. Do not dispose of as household waste.
- For more information, contact the retailer or the local authorities in charge of waste management.

This symbol on the battery indicates that the battery is to be collected separately.









The following apply only to users in European countries:













- All batteries, whether marked with this symbol or not, are designated for separate collection at an appropriate collection point. Do not dispose of as household waste.
- For more information, contact the retailer or the local authorities in charge of waste management.



















# Table of Contents



















For Your Safety.....	ii
WARNINGS.....	ii
Notices.....	v
<hr/>	
Introduction.....	1
About This Manual.....	1
Information and Precautions.....	2
Parts of the Camera.....	4
The Camera Body.....	4
Basic Operations.....	6
The  (Shooting Mode) Button.....	6
The  (Playback) Button.....	6
The  (Movie-record) Button.....	6
Shutter-release Button.....	7
Attaching the Camera Strap.....	7
Operating the Touch Panel.....	8
Tapping.....	8
Dragging.....	8
Dragging and Dropping.....	8
Using the Stylus.....	9
Main Display of the Monitor/Touch Panel and Basic Operations.....	10
Shooting (Information Display).....	10
Shooting (Operation Controls).....	11
Playback (Information Display).....	12
Playback (Operation Controls).....	13
Operating the Tabs.....	14
<hr/>	
First Steps.....	16
Inserting the Battery.....	16
Removing the Battery.....	17
Charging the Battery.....	18
Turning On and Off the Camera.....	21
Setting Display Language, Date and Time.....	22
Inserting Memory Cards.....	24
Removing Memory Cards.....	24
<hr/>	
Basic Photography and Playback:  (Auto) Mode.....	26
Step 1 Turn the Camera On and Select  (Auto) Mode.....	26
Indicators Displayed in  (Auto) Mode.....	27
Step 2 Frame a Picture.....	28
Using the Zoom.....	29
Step 3 Focus and Shoot.....	30
Step 4 Playing Back and Deleting Images.....	32
Playing Back Images (Playback Mode).....	32
Deleting Unwanted Images.....	33

## Table of Contents

Using the Basic Shooting Functions .....	34
 Flash Mode.....	34
 Taking Pictures with the Self-timer.....	37
 Macro Mode.....	39
 Changing the Brightness Using Exposure Compensation.....	40
<hr/>	
More on Shooting .....	41
Selecting a Shooting Mode .....	41
Adjusting the  (Auto) Mode setting .....	44
 Image Mode (Changing Image Quality/Image Size) .....	45
 Touch Shutter (Tapping the Monitor to Release the Shutter) .....	47
 Subject Tracking (Focusing on a Moving Subject).....	50
 Touch AF/AE (Tapping the Monitor to Focus).....	52
 ISO Sensitivity .....	55
 Continuous .....	56
 White Balance (Adjusting Hue) .....	57
Shooting Suited to Scenes (Scene Mode) .....	59
Selecting a Scene Mode.....	59
Shooting in the Scene Mode Selected by the Camera (Scene Auto Selector).....	62
Selecting a Scene Mode to Take Pictures (Features).....	64
Using the Draw Option .....	72
Shooting for a Panorama.....	74
Shooting Smiling Faces (Smart Portrait Mode) .....	76
Changing the Smart Portrait Mode Settings.....	78
Camera Settings That Cannot Be Applied Simultaneously.....	80
<hr/>	
More on Playback .....	82
Operations in Full-frame Playback Mode .....	82
Viewing Multiple Images: Thumbnail Playback.....	83
Taking a Closer Look: Playback Zoom .....	85
Selecting Playback Mode .....	87
Sorting Favorite Pictures (Favorite Pictures Mode) .....	88
Adding Images to Albums .....	88
Viewing Images in an Album .....	90
Removing Images from Albums .....	91
Operations in Favorite Pictures Mode .....	92
Changing Icons Assigned to Albums.....	93
Image Searching in Auto Sort Mode .....	95
Viewing Images in Auto Sort Mode .....	95
Operations in Auto Sort Mode .....	97
Selecting Images Captured on a Specific Day (List by Date Mode) .....	98
Selecting a Date in List by Date Mode .....	98
Operations in List by Date Mode .....	99
Playback Options .....	100

Setting the Image Rating .....	101
Playing Back Images by Rating.....	101
 Enjoying Slide Show .....	102
 Protecting Important Images (Protect).....	104
Protecting One Image .....	104
Protecting Multiple Images.....	105
Removing Protection from Images.....	105
 Creating a DPOF Print Order.....	106
Creating a Print Order for One Image.....	106
Creating a Print Order for Multiple Images.....	108
Canceling Print Order.....	109
 Rotate Image.....	110
 Voice Memo: Recording and Playback.....	111
Recording Voice Memos.....	111
Playing Voice Memos.....	112
Deleting Voice Memos.....	112
<hr/>	
Editing Images.....	113
Editing Functions.....	113
Image Editing .....	115
 Paint.....	115
 Quick Retouch: Enhancing Contrast and Saturation .....	118
 D-Lighting: Enhancing Brightness and Contrast.....	119
 Stretch: Stretching Images.....	120
 Perspective Control: Adjusting a Sense of Perspective.....	121
 Filter Effects (Digital Filter).....	122
 Glamour Retouch.....	124
 Small Picture: Decreasing Image Size.....	126
 Crop: Creating a Cropped Copy .....	127
<hr/>	
Movie Recording and Playback.....	128
Recording Movies .....	128
Changing the Movie Recording Settings .....	130
 Movie Options .....	130
 Movie AF Mode .....	131
 Wind Noise Reduction.....	132
Movie Playback.....	133
<hr/>	
Connecting to Televisions, Computers and Printers.....	134
Connecting to a TV.....	134
Connecting to a Computer.....	137
Before Connecting the Camera.....	137
Transferring Images from a Camera to a Computer.....	138
Charging While Connecting to a Computer .....	142

## Table of Contents

Connecting to a Printer.....	143
Connecting the Camera to a Printer.....	144
Printing Images One at a Time.....	145
Printing Multiple Images.....	146
<hr/>	
Basic Camera Setup.....	149
Setup Menu.....	149
 Welcome Screen.....	151
 Time Zone and Date.....	152
 Monitor Settings.....	155
 Print Date (Imprinting Date and Time).....	157
 Vibration Reduction.....	158
 Motion Detection.....	159
 AF Assist.....	160
 Digital Zoom.....	160
 Sound Settings.....	161
 Auto Off.....	162
 Format Memory/Format Card.....	163
 Language.....	164
 TV Settings.....	164
 Charge by Computer.....	165
 Blink Warning.....	166
 Reset All.....	168
 Copy (Copy Between Internal Memory and Memory Card).....	171
 Firmware Version.....	172
<hr/>	
Caring for the Camera.....	173
Maximizing Camera Life and Performance.....	173
Cleaning.....	175
Storage.....	175
<hr/>	
Technical Notes and Index.....	176
Optional Accessories.....	176
Approved Memory Cards.....	177
File and Folder Names.....	178
Error Messages.....	179
Troubleshooting.....	184
Specifications.....	192
Supported Standards.....	196
Index.....	197

# About This Manual

Thank you for your purchase of a Nikon COOLPIX S6100 digital camera. This manual was written to help you enjoy taking pictures with your Nikon digital camera. Read this manual thoroughly before use, and keep it where all those who use the product will read it.

## Symbols and Conventions

To make it easier to find the information you need, the following symbols and conventions are used:



This icon marks cautions, information that should be read before use, to prevent damage to the camera.



This icon marks tips, additional information that may be helpful when using the camera.



This icon marks notes, information that should be read before using the camera.



This icon indicates that more information is available elsewhere in this manual.

## Notations

- Secure Digital (SD) memory card, SDHC memory card, and SDXC memory card are referred to as “memory card.”
- The setting at the time of purchase is referred to as the “default setting.”
- The names of menu items displayed in the camera monitor, and the names of buttons or messages displayed on a computer monitor appear in bold.

## Screen Samples

In this manual, images are sometimes omitted from monitor display samples so that monitor indicators can be more clearly shown.

## Illustrations and Screen Display

Illustrations and text displays shown in this manual may differ from actual display.

## Internal Memory and Memory Cards

Pictures taken with this camera can be stored in the camera’s internal memory or on removable memory cards. If a memory card is inserted, all new pictures will be stored on the memory card and delete, playback and format operations will apply only to the pictures on the memory card. The memory card must be removed before the internal memory can be formatted or accessed for picture storage, deletion, or viewing.

# Information and Precautions

## Life-Long Learning

As part of Nikon's "Life-Long Learning" commitment to ongoing product support and education, continually updated information is available online at the following sites:

- For users in the U.S.A.: <http://www.nikonusa.com/>
- For users in Europe and Africa: <http://www.europe-nikon.com/support/>
- For users in Asia, Oceania, and the Middle East: <http://www.nikon-asia.com/>

Visit these sites to keep up-to-date with the latest product information, tips, answers to frequently asked questions (FAQs), and general advice on digital imaging and photography. Additional information may be available from the Nikon representative in your area. Visit the site below for contact information:

<http://imaging.nikon.com/>

## Use Only Nikon Brand Electronic Accessories

Nikon COOLPIX cameras are designed to the highest standards and include complex electronic circuitry. Only Nikon brand electronic accessories (including battery charger, batteries, Charging AC Adapter, and AC adapters) certified by Nikon specifically for use with this Nikon digital camera are engineered and proven to operate within the operational and safety requirements of this electronic circuitry.

THE USE OF NON-NIKON ELECTRONIC ACCESSORIES COULD DAMAGE THE CAMERA AND MAY VOID YOUR NIKON WARRANTY.

The use of third-party rechargeable Li-ion batteries not bearing the Nikon holographic seal could interfere with normal operation of the camera or result in the batteries overheating, igniting, rupturing, or leaking.

For more information about Nikon brand accessories, contact a local authorized Nikon dealer.



### Holographic seal:

Identifies this device as an authentic Nikon product.

## Before Taking Important Pictures

Before taking pictures on important occasions (such as at weddings or before taking the camera on a trip), take a test shot to ensure that the camera is functioning normally. Nikon will not be held liable for damages or lost profits that may result from product malfunction.

## About the Manuals

- No part of the manuals included with this product may be reproduced, transmitted, transcribed, stored in a retrieval system, or translated into any language in any form, by any means, without Nikon's prior written permission.
- Nikon reserves the right to change the specifications of the hardware and software described in these manuals at any time and without prior notice.
- Nikon will not be held liable for any damages resulting from the use of this product.
- While every effort was made to ensure that the information in these manuals is accurate and complete, we would appreciate it were you to bring any errors or omissions to the attention of the Nikon representative in your area (address provided separately).

## Notice Concerning Prohibition of Copying or Reproduction

Note that simply being in possession of material that was digitally copied or reproduced by means of a scanner, digital camera or other device may be punishable by law.

- **Items prohibited by law from being copied or reproduced**

Do not copy or reproduce paper money, coins, securities, government bonds or local government bonds, even if such copies or reproductions are stamped "Sample." The copying or reproduction of paper money, coins, or securities which are circulated in a foreign country is prohibited. Unless the prior permission of the government was obtained, the copying or reproduction of unused postage stamps or post cards issued by the government is prohibited. The copying or reproduction of stamps issued by the government and of certified documents stipulated by law is prohibited.

- **Cautions on certain copies and reproductions**

The government has issued cautions on copies or reproductions of securities issued by private companies (shares, bills, checks, gift certificates, etc.), commuter passes or coupon tickets, except when a minimum of necessary copies are to be provided for business use by a company. Also, do not copy or reproduce passports issued by the government, licenses issued by public agencies and private groups, ID cards and tickets, such as passes and meal coupons.

- **Comply with copyright notices**

The copying or reproduction of copyrighted creative works such as books, music, paintings, woodcut prints, maps, drawings, movies and photographs is governed by national and international copyright laws. Do not use this product for the purpose of making illegal copies or to infringe copyright laws.

## Disposing of Data Storage Devices

Please note that deleting images or formatting data storage devices such as memory cards or built-in camera memory does not completely erase the original image data. Deleted files can sometimes be recovered from discarded storage devices using commercially available software, potentially resulting in the malicious use of personal image data. Ensuring the privacy of such data is the user's responsibility.

Before discarding a data storage device or transferring ownership to another person, erase all data using commercial deletion software, or format the device and then completely refill it with images containing no private information (for example, pictures of empty sky). Be sure to also replace any pictures selected for the welcome screen (📖 151). Care should be taken to avoid injury or damage to property when physically destroying data storage devices.

# Parts of the Camera

## The Camera Body

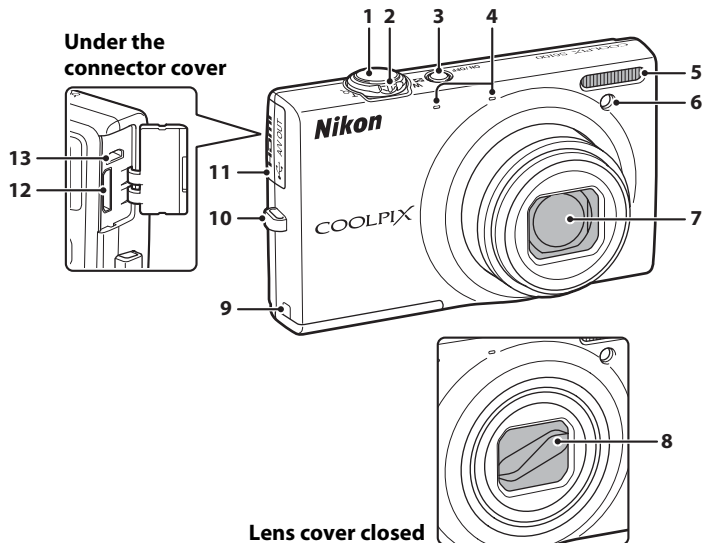

<b>1</b>	Shutter-release button.....	30	<b>7</b>	Lens.....	175, 192	
	Zoom control.....	29	<b>8</b>	Lens cover.....	173	
	<b>W</b> : wide-angle.....	29		Power connector cover (for connection with an optional AC Adapter).....	176	
<b>2</b>	<b>T</b> : telephoto.....	29	<b>9</b>	<b>10</b>	Eyelet for camera strap.....	7
	: thumbnail playback.....	83		<b>11</b>	Connector cover.....	134, 138, 144
	: playback zoom.....	85	<b>12</b>	<b>13</b>	HDMI mini connector (Type C).....	135
<b>3</b>	Power switch/power-on lamp.....	26, 162			USB/audio/video output connector.....	134, 138, 144
<b>4</b>	Built-in microphone (stereo)....	111, 128				
<b>5</b>	Flash.....	34				
<b>6</b>	Self-timer lamp.....	37				
	AF-assist illuminator.....	160				



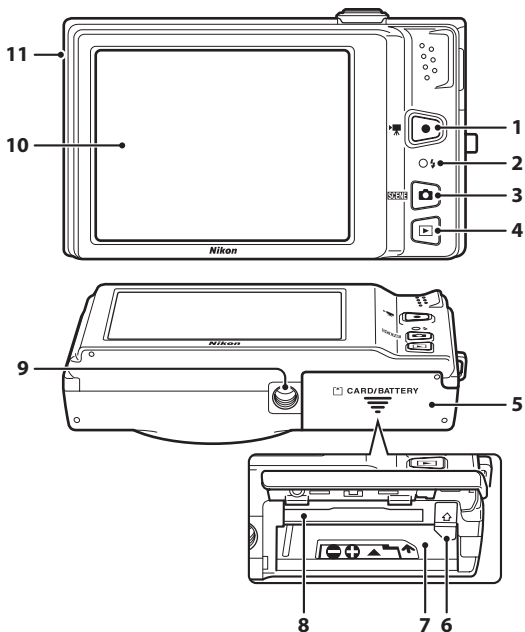





<b>1</b>	● (movie-record) button.....	6, 128
<b>2</b>	Charge lamp .....	19, 165
	Flash lamp .....	35
<b>3</b>	📷 (shooting mode) button.....	6, 41
<b>4</b>	▶ (playback) button .....	6, 32, 87
<b>5</b>	Battery-chamber/ memory card slot cover .....	16, 24

<b>6</b>	Battery latch.....	16, 17
<b>7</b>	Battery chamber.....	16
<b>8</b>	Memory card slot.....	24
<b>9</b>	Tripod socket	
<b>10</b>	Monitor/touch panel.....	10
<b>11</b>	Speaker .....	112, 133

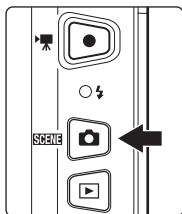
## Basic Operations





### The (Shooting Mode) Button

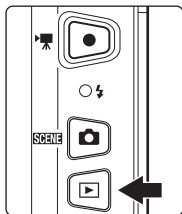

- Press the  button in playback mode to enter shooting mode.
- Press the  button in shooting mode to display the shooting-mode selection menu and switch shooting modes ( 41).





### The (Playback) Button

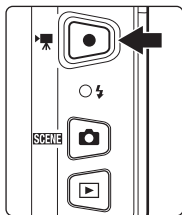

- Press the  button in shooting mode to enter playback mode.
- Press the  button in playback mode to display the playback-mode selection menu and switch playback modes ( 87).
- If the camera is turned off, hold down the  button to turn the camera on in playback mode.

### The (Movie-record) Button



- Press the  (movie-record) button in shooting mode to start movie recording ( 128). Press the  (movie-record) button again to stop movie recording.
- Press the  (movie-record) button in playback mode to enter shooting mode.

## Shutter-release Button

The camera features a two-stage shutter-release button. To set focus and exposure, press the shutter-release button halfway, stopping when you feel resistance. When the shutter-release button is pressed halfway, focus and exposure (shutter speed and aperture value) are set. Focus and exposure remain locked while the shutter-release button is pressed halfway.

While the shutter-release button is held in this position, release the shutter and take a picture by pressing the shutter-release button the rest of the way down. Do not use force when pressing the shutter-release button, as this may result in camera shake and blurred images.



Press the shutter-release button halfway to set focus and exposure



Press the shutter-release button the rest of the way down to take a picture

## Attaching the Camera Strap

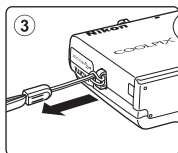
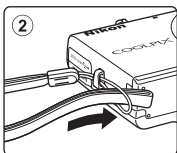
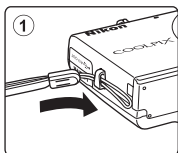

## Operating the Touch Panel

The monitor on the COOLPIX S6100 is a touch panel display. Use a finger or the supplied stylus to operate the touch panel.

### Tapping

#### Tap the touch panel.

Use this operation to:

Select icons or other controls

Select images in thumbnail playback mode (📖 83)

Perform touch shutter (📖 47), subject tracking (📖 50), or touch AF/AE (📖 52) operations

Drag the tab to display the setting controls during shooting or playback (📖 14)

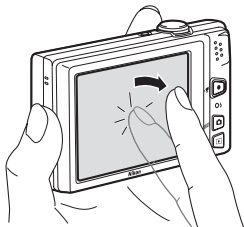

### Dragging

#### Drag your finger across the touch panel and remove it from the touch panel.

Use this operation to:

Scroll through images in full-frame playback mode (📖 32)

Move the visible portion of an image enlarged with playback zoom (📖 85)

Use sliders to adjust exposure compensation (📖 40) or other settings

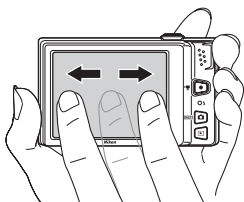

### Dragging and Dropping

#### Place your finger on the touch panel, drag it to the desired location (①), and remove it from the touch panel (②).

Use this operation to:

Apply the rating setting (📖 101)

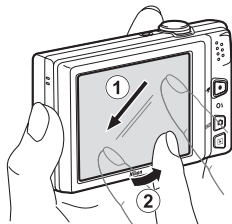

## Using the Stylus

Use the stylus for operations that require more precision than using a finger, such as when using the draw option (📖 72) or the paint option (📖 116).



## Attaching the Stylus

Attach the stylus to the strap as shown.

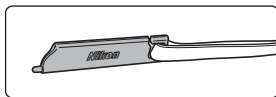

### ✔ Notes on the Touch Panel

- Do not press on the touch panel with pointed objects other than the supplied stylus.
- Do not apply unnecessary pressure to the touch panel.

### ✔ Notes on Tapping/Dragging

- When tapping, the camera may not respond if your finger is left in one place too long.
- When dragging, the camera may not respond if you do any of the following:
  - Bounce your finger off the display
  - Drag your finger over too short a distance
  - Stroke the display too lightly
  - Move your finger too quickly
- When tapping the touch panel, the camera may not respond properly if something else is touching another area of the touch panel.

### ✔ Notes on the Stylus

- Keep the stylus out of reach of small children.
- Do not carry the camera by the stylus. The stylus may slip off the strap and the camera may fall.

# Main Display of the Monitor/Touch Panel and Basic Operations

## Shooting (Information Display)

Displayed information on the monitor varies depending on the camera settings or status.

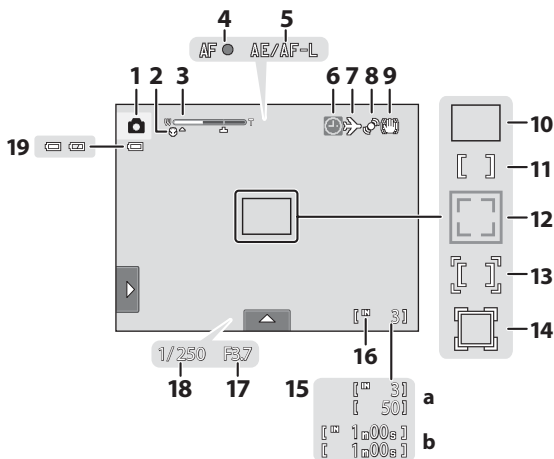

<b>1</b>	Shooting mode <sup>1</sup> .....	26, 59, 76	<b>11</b>	Focus area (center)
<b>2</b>	Macro mode .....	39	<b>12</b>	Focus area (face detection, pet detection) ....
<b>3</b>	Zoom indicator .....	29, 39	<b>13</b>	Focus area (touch AF/AE) .....
<b>4</b>	Focus indicator .....	30	<b>14</b>	Focus area (subject tracking mode) ...
<b>5</b>	AE/AF-L indicator .....	75	<b>a</b>	Number of exposures remaining (still images) <sup>2</sup> .....
<b>6</b>	☺ "Date not set" indicator .....	179	<b>b</b>	Movie length .....
	DATE DATE Print date indicator .....	157	<b>15</b>	Internal memory indicator .....
<b>7</b>	Travel destination icon .....	152	<b>16</b>	Aperture .....
<b>8</b>	Motion detection .....	159	<b>17</b>	Shutter speed .....
<b>9</b>	Vibration reduction icon .....	158	<b>18</b>	Battery level indicator .....
<b>10</b>	Focus area (auto) .....	30		

<sup>1</sup> Indicators displayed vary with current shooting mode.

<sup>2</sup> Indicator is displayed when there are 50 or fewer exposures remaining.

## Shooting (Operation Controls)

Tap the following controls to change settings.

- Tap the tab to display the setting controls and shooting settings can be changed (📖 14).
- The controls available and indicators displayed vary with shooting mode and the current camera settings.

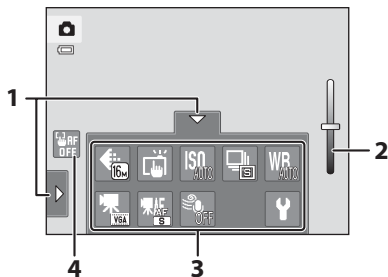

**1** Tab ..... 14

**2** Scene effect adjustment slider ..... 61

**3** Setting controls ..... 15

**4** Touch AF/AE cancellation ..... 52

## Playback (Information Display)

The following monitor display shows information for the image currently displayed and camera status.

- The displayed information varies depending on the image played back and the current camera status.
- Indicators below are displayed when turning on the camera or operating the camera, and turn off after a few seconds elapse ( 155).

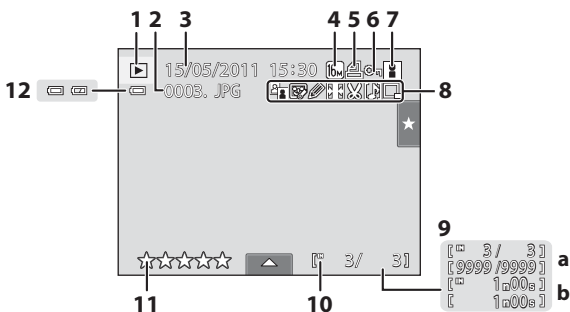

<b>1</b>	Playback mode <sup>1</sup> .....	32, 88, 95, 98
<b>2</b>	File number and type .....	178
<b>3</b>	Date/time of recording.....	22
<b>4</b>	 Image mode <sup>2</sup> .....	45
	 Movie options <sup>2</sup> .....	130
<b>5</b>	Print order icon .....	106
<b>6</b>	Protect icon.....	104
<b>7</b>	Album icon in favorite pictures mode <sup>3</sup> .....	90
	Category icon in auto sort mode <sup>3</sup> .....	95

<b>8</b>	Quick retouch icon .....	118
	D-Lighting icon .....	119
	Glamour retouch icon .....	124
	Filter effects icon .....	122
	Paint icon .....	115
	Stretch icon .....	120
	Perspective control icon.....	121
	Crop icon .....	127
<b>9</b>	Voice memo icon.....	112
	Small picture icon.....	126
<b>a</b>	Current frame number/ total number of frames .....	32
	<b>b</b> Movie length.....	133
<b>10</b>	Internal memory indicator.....	27
<b>11</b>	Rating indicator .....	101
<b>12</b>	Battery level indicator.....	26

<sup>1</sup> Indicators displayed vary with current playback mode.

<sup>2</sup> Indicators displayed vary depending on the setting for shooting.

<sup>3</sup> The icon for the selected album or category in auto sort mode currently selected in playback mode is displayed.



## Playback (Operation Controls)

Tap the following controls to change settings.

- Tap the tab to display the setting controls and delete or edit images (📖 14).
- The controls available and indicators displayed vary with the image played back and the current camera settings.

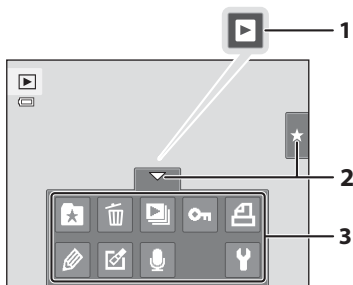





**1** Movie playback..... 133

**2** Tab..... 14

**3** Setting controls..... 15

## Operating the Tabs

When in shooting or playback mode, use the setting controls to make shooting or playback settings. Display the controls by tapping the tab at the bottom, left and right sides of the monitor.

- Tap the icon of the desired item to display the setting screen for that item.
- Tap  (setup) in the setting controls to make the basic camera settings.
- When  or  is displayed on the setting screen, tap  to exit the setting screen. Tap  to return to the previous screen.
- Tap the tab again to hide the setting controls.

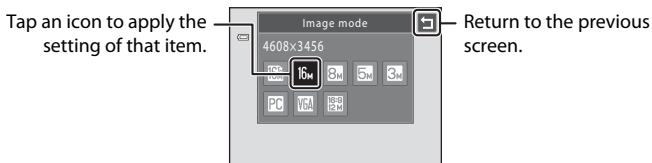
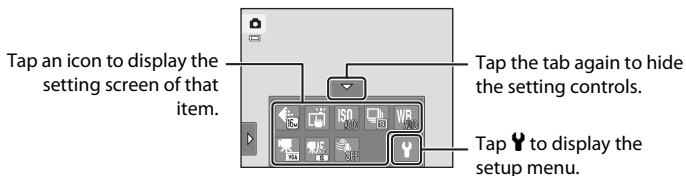
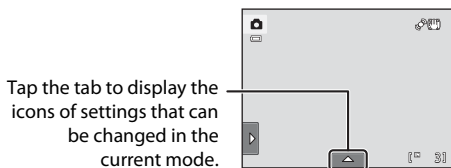

## Shooting

Shooting settings can be made.

- The available setting items vary depending on the shooting mode (📖 41).
- Each icon also indicates the current setting.

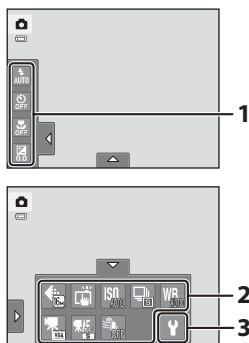

1	Flash mode .....	34
	Self-timer .....	37
	Macro mode .....	39
	Exposure compensation .....	40
	Image mode .....	45
	Touch shooting	
	Touch shutter .....	47
	Subject tracking .....	50
	Touch AF/AE .....	52
2	ISO ISO sensitivity .....	55
	Continuous .....	56
	White balance .....	57
	Movie options .....	130
	Movie AF mode .....	131
	Wind noise reduction .....	132
3	Set up .....	149

## Playback

Images can be edited and deleted, and playback settings can be made.

- The available setting items vary depending on the type of image or playback mode.

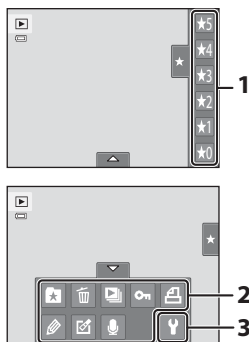

1	Rating .....	101
	★ Add images to albums (except in favorite pictures mode) .....	88
	Remove images from albums (in favorite pictures mode) .....	91
2	🗑️ Delete .....	33
	🎞️ Slide show .....	102
	🔒 Protect .....	104
	📄 DPOF print order .....	106
	🎨 Paint .....	115
	🔍 Retouch .....	113
	🗣️ Voice memo .....	111
3	Set up .....	149

## Inserting the Battery

Insert a Rechargeable Li-ion Battery EN-EL12 (supplied) into the camera.

- Charge the battery before the first use or when the battery is running low (📖 18).

- 1 Open the battery-chamber/memory card slot cover.

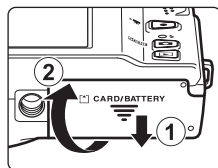

- 2 Insert the battery.

Use the battery to push up the orange battery latch in the direction indicated by the arrow (①) and fully insert the battery (②).

When the battery is fully inserted, the battery latch will lock it in place.

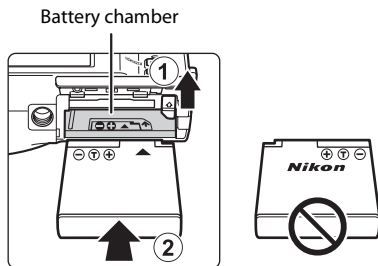

### ✔ Inserting the Battery

**Inserting the battery upside down or backwards could damage the camera.** Be sure to check that the battery is in the correct orientation.

- 3 Close the battery-chamber/memory card slot cover.

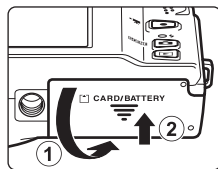

## Removing the Battery

Turn the camera off (📖 21) and be sure that the power-on lamp and the monitor have turned off before opening the battery-chamber/memory card slot cover.

To eject the battery, open the battery-chamber/memory card slot cover and slide the orange battery latch in the direction indicated by the arrow (①). The battery can then be removed by hand (②).

- Note that the camera, battery, and memory card may become hot during use; observe due caution when removing the battery.

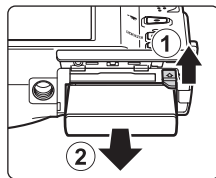

### ✓ Notes on the Battery

- Be sure to read and follow the warnings for the battery on page iii and the section, “The Battery” (📖 174), before using the battery.
- If the battery is not used for an extended period, recharge it at least once every six months and completely exhaust it before returning it to storage.

# Charging the Battery

Charge the supplied Rechargeable Li-ion Battery EN-EL12 inserted into the camera, by connecting the supplied Charging AC Adapter EH-69P to the camera via the supplied USB Cable UC-E6, and then plugging the Charging AC Adapter into an electrical outlet.

## 1 Prepare the Charging AC Adapter EH-69P.

If a plug adapter\* is included, attach the plug adapter to the plug on the Charging AC Adapter. Push the plug adapter firmly until it is securely held in place. Once the two are connected, attempting to forcibly remove the plug adapter could damage the product.

\* The shape of the plug adapter varies according to the country or region in which the camera was purchased.  
The Charging AC Adapter comes with the plug adapter attached in Argentina and Korea.

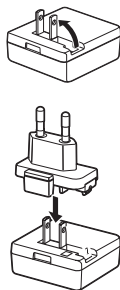

## 2 Insert the battery (📖 16).

Do not turn the camera on.

## 3 Use the supplied USB cable to connect the Charging AC Adapter to the camera.

Be sure that connectors are properly oriented. Do not attempt to insert connectors at an angle, and do not use force when connecting or disconnecting the USB cable.

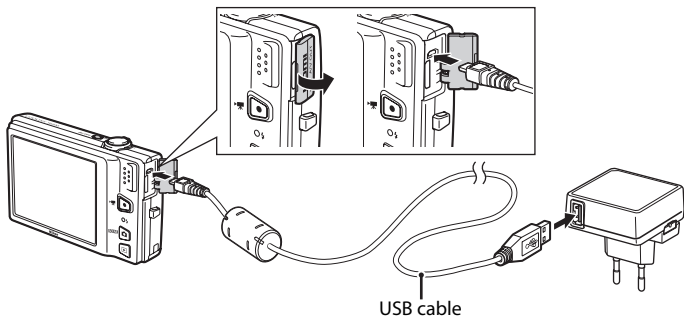

## 4 Plug the Charging AC Adapter into an electrical outlet.

The charge lamp slowly blinks green to indicate that the battery is charging.

About 3 hours and 20 minutes are required to charge a fully exhausted battery.

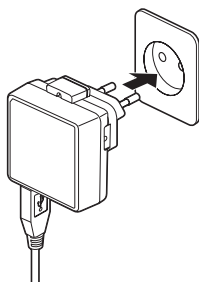

The following chart explains charge lamp status when the camera is plugged into the electrical outlet.

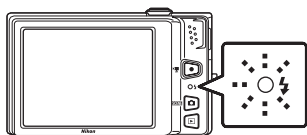

Charge lamp	Description
Blinks slowly (green)	Battery charging.
Off	Battery not charging. When charging is complete, the charge lamp stops blinking green and turns off.
Flickers (green)	<ul style="list-style-type: none"> <li>The ambient temperature is not suited to charging. Charge the battery indoors with an ambient temperature of 5 °C to 35 °C (41 °F to 95 °F).</li> <li>The USB cable or Charging AC Adapter is not properly connected, or there is a problem with the battery. Disconnect the USB cable or unplug the Charging AC Adapter and correctly connect it again, or change the battery.</li> </ul>

## 5 Disconnect the Charging AC Adapter from the electrical outlet and then disconnect the USB cable.

### **Notes on Charging AC Adapter**

- The Charging AC Adapter EH-69P is for use only with compatible devices. Do not use with another make or model of device.
- Be sure to read and follow the warnings for the Charging AC Adapter EH-69P on page iii and the section, "The Battery" (📖 174), before use.
- The Charging AC Adapter EH-69P is compatible with AC 100-240 V, 50/60 Hz electrical outlets. When using in other countries, use a plug adapter (available commercially) as necessary. For more information about plug adapters, consult your travel agency.
- The Charging AC Adapter EH-69P is for charging the battery inserted into the camera. When the camera is connected to an electrical outlet with the Charging AC Adapter EH-69P, the camera cannot be turned on.
- Do not, under any circumstances, use another make or model of USB-AC adapter other than the Charging AC Adapter EH-69P. Failure to observe this precaution could result in overheating or in damage to the camera.

### **Notes on AC Power Supply**

- If the AC Adapter EH-62F (available separately; 📖 176) is used, power is supplied to the camera from an electrical outlet and taking pictures and playing back images are available with this camera.
- Do not, under any circumstances, use another make or model of AC adapter other than the AC Adapter EH-62F. Failure to observe this precaution could result in overheating or in damage to the camera.

### **Charging Using Computer or Battery Charger**

- Connecting the COOLPIX S6100 to a computer also charges the Rechargeable Li-ion Battery EN-EL12 (📖 137, 165).
- The Rechargeable Li-ion Battery EN-EL12 can be charged without using the camera by using the Battery Charger MH-65 (available separately; 📖 176).



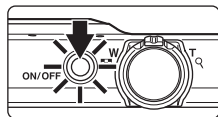

## Turning On and Off the Camera

To turn on the camera, press the power switch. The power-on lamp (green) will light and the monitor will turn on (the power-on lamp turns off when the monitor turns on).



To turn off the camera, press the power switch again.





When the camera is turned off, both the power-on lamp and monitor will turn off.

- If the camera is turned off, hold down the  button to turn the camera on in playback mode ( 32).

## Power Saving Function (Auto Off)

If no operations are performed for a while, the monitor will turn off, the camera will enter standby mode, and the power-on lamp will blink. If no operations are performed for another three minutes, the camera will turn off automatically.

To reactivate the monitor while the power on lamp is blinking, press any of the following buttons:

- Power switch, shutter-release button,  button,  button or  (movie-record) button
- Camera enters standby mode in about a minute (default setting) during shooting or playback mode.
- The time allowed to elapse before the camera enters standby mode can be changed from the **Auto off** option ( 162) in the setup menu ( 149).

# Setting Display Language, Date and Time



A language-selection dialog is displayed the first time the camera is turned on.

## 1 Press the power switch to turn on the camera.

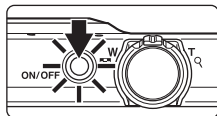
The power-on lamp (green) will light and the monitor will turn on (the power-on lamp turns off when the monitor turns on).



## 2 Tap the desired language.

If the desired language is not displayed, tap  or  to view other language options.

For more information about operating the touch panel, see "Operating the Touch Panel" (📖 8).



## 3 Tap Yes.

To cancel setting the time zone and date, tap **No**.

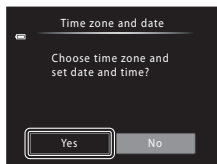



## 4 Tap or to select your home time zone (📖 154) and tap **OK**.

Tap  to return to the previous screen.



## Daylight Saving Time

If daylight saving time is in effect, tap  in the time zone selection screen displayed in step 4 to turn on the daylight saving time option.



When the daylight saving time option is enabled,  is displayed at the top of the monitor. To turn off the daylight saving time option, tap  again.

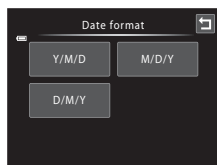

- 5** Tap the order in which the day, month, and year are displayed.



- 6** Edit the date and time.

Tap the desired item (D, M, Y, Hour, and Minute) and  or  to edit the highlighted item.

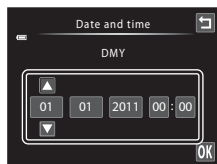



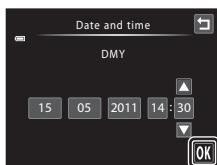

- 7** Tap **OK**.

When settings are finished, the lens extends and the camera switches to shooting mode.



## Imprinting and Changing the Date and Time

- To imprint the date on images when shooting, enable date imprint from the **Print date** option ( 157) in the setup menu ( 149) after the date and time have been set.
- To change the date and time settings of the camera clock, select **Time zone and date** ( 152) in the setup menu ( 149).

## Inserting Memory Cards

Image, sound, and movie files are saved in the camera's internal memory (approximately 20 MB) or on removable Secure Digital (SD) memory cards (available commercially;  177).

**If a memory card is inserted in the camera, data are automatically saved on the memory card and data saved to the memory card can be played back, deleted or transferred. Remove the memory card to save data in the internal memory, or play back, delete or transfer data from the internal memory.**

- 1 Be sure that the power-on lamp and the monitor are off and open the battery-chamber/memory card slot cover.

Be sure to turn off the camera before opening the cover.

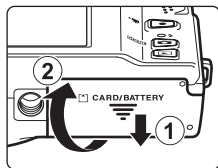

- 2 Insert the memory card.

Slide the memory card in correctly until it clicks into place.

Memory card slot

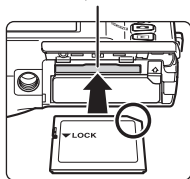

### Inserting Memory Cards

**Inserting the memory card upside down or backwards could damage the camera or the memory card.** Be sure to check that the memory card is in the correct orientation.

- 3 Close the battery-chamber/memory card slot cover.

## Removing Memory Cards

Before removing memory cards, turn the camera off and confirm that the power-on lamp and monitor are off. Press the card in (1) to partially eject the card, then remove the card by hand while being careful not to remove the card at an angle (2).

- Note that the camera, battery, and memory card may become hot during use; observe due caution when removing the memory card.

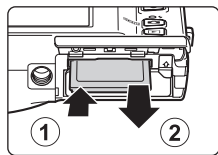

## ✓ Formatting Memory Cards

If the message on the right is displayed when the camera is turned on, the memory card must be formatted before use (📖 163). Note that **formatting permanently deletes all images and other data on the memory card**. Be sure to make copies of any images you wish to keep before formatting the memory card.

Tap **Yes** to format. When the confirmation dialog is displayed, tap **Yes**. To start formatting, tap **OK**.

- Do not turn the camera off or open the battery-chamber/memory card slot cover until formatting is complete.
- Be sure to use this camera to format memory cards previously used in other devices the first time they are inserted into the COOLPIX S6100 (📖 163).

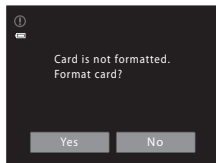

## ✓ The Write Protect Switch

When memory card's switch is in the "lock" position, data cannot be written to, or deleted from, the memory card. If the switch is in the "lock" position, unlock it by sliding the switch to the "write" position to save or delete images, or to format the memory card.

Write protect switch

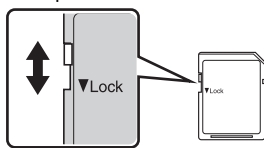

## ✓ Memory Cards

- Use only Secure Digital memory cards.
- Do not perform the following during formatting, while data is being written to or deleted from the memory card, or during data transfer to a computer. Failure to observe this precaution could result in the loss of data or in damage to the camera or memory card:
  - Take out the battery or memory card
  - Turn off the camera
  - Disconnect the AC adapter
- Do not format the memory card using a computer.
- Do not disassemble or modify.
- Do not drop, bend, or expose to water or strong physical shock.
- Do not touch the metal terminals with your fingers or metal objects.
- Do not affix labels or stickers to the memory card.
- Do not leave in direct sunlight, closed vehicles or areas exposed to high temperatures.
- Do not expose to humidity, dust, or corrosive gases.



**Step 1 Turn the Camera On and Select  (Auto) Mode**

This section describes taking pictures in  (auto) mode, an automatic, “point-and-shoot” mode recommended for first-time users of digital cameras.

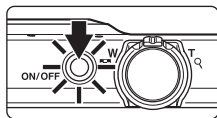
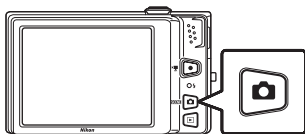

**1 Press the power switch to turn on the camera.**

The lens extends and the monitor will turn on.

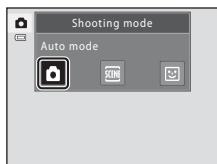
 (auto) mode is initially activated at the time of purchase. Proceed to step 4.

**2 Press the  button.****3 Tap  in the monitor.****4 Check the battery level indicator and the number of exposures remaining.**

Battery level indicator

Display	Description
	Battery level high.
	Battery level low. Prepare to charge or replace the battery.
 <b>Battery exhausted.</b>	Cannot take pictures. Charge or replace the battery.

Battery level indicator

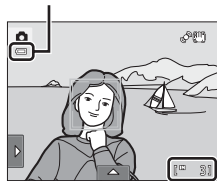

Number of exposures remaining

**Number of Exposures Remaining**

Indicator is displayed when there are 50 or fewer exposures remaining.

The number of images that can be saved varies depending on the capacity of the internal memory or memory card and image mode setting (📖 45).

## Indicators Displayed in (Auto) Mode

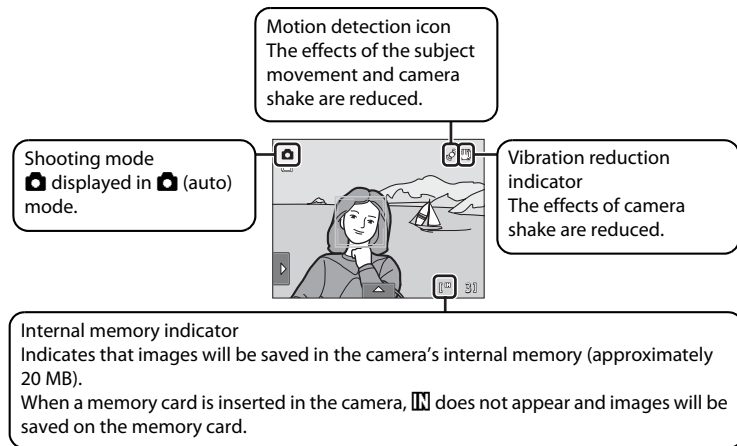



When the monitor has turned off in standby mode to save power (the power-on lamp is blinking) ( 162), press the following buttons to turn it back on.

- Power switch, shutter-release button,  button or  (movie-record) button



### **Note on Touch Shutter**

At the default setting, the shutter can be released by simply tapping a subject in the monitor ( 47). Take care that you do not release the shutter accidentally.

### **Functions Available in (Auto) Mode**

- When the camera is pointed at a human face, the face detection function, with which the camera automatically detects that face and focuses on it, activates ( 30).
- Shooting settings ( 44) can be changed by tapping the left or bottom tab to display the setting controls.

### **Vibration Reduction and Motion Detection**

See **Vibration reduction** ( 158) or **Motion detection** ( 159) in the setup menu ( 149) for more information.

## Step 2 Frame a Picture

### 1 Ready the camera.

Hold the camera steadily in both hands, keeping your fingers and other objects away from the lens, flash, AF-assist illuminator, and built-in microphone.

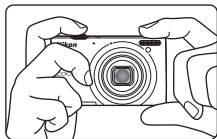

When taking pictures in portrait ("tall") orientation, turn the camera so that the built-in flash is above the lens.

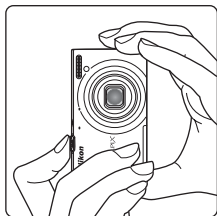

### 2 Frame the picture.

A face detected by the camera will be framed by a yellow double border (focus area).

Up to 12 faces can be detected. If more than one face is detected, the face closest to the camera will be framed by a double border, and the others by a single border.

When taking pictures of subjects other than people, or framing a subject with which no face is detected, a focus area will not be displayed. Frame the picture so that the intended subject is at or near the center of the frame.



### ✓ Notes on Tripod Use

- When attaching the camera to a tripod, be careful not to open the battery-chamber/memory card slot cover and tighten the tripod screw.
- Set **Vibration reduction** (📖 158) to **Off** when using a tripod to stabilize the camera during shooting.



## Using the Zoom

Use the zoom control to activate optical zoom. Rotate the zoom control toward **T** to zoom in, increasing the size of the subject. Rotate the zoom control toward **W** to zoom out, increasing the area visible in the frame.

- The zoom position is set at the maximum wide-angle position when the camera is turned on.
- A zoom indicator is displayed at the top of the monitor when the zoom control is rotated.

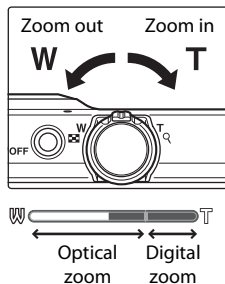

## Digital Zoom

When the camera is zoomed in to the maximum optical zoom position, rotating and holding the zoom control at **T** triggers digital zoom.

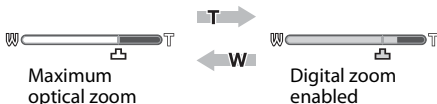

Digital zoom can magnify the subject up to about 4x beyond the maximum magnification of the optical zoom.



The camera focuses at the center of the frame and the focus area is not displayed when digital zoom is in effect.

## Digital Zoom and Interpolation

Unlike optical zoom, digital zoom uses a digital imaging process known as interpolation to magnify images, resulting in slight deterioration of image quality according to the image mode (📖 45) and digital zoom magnification.

Interpolation is applied at zoom positions beyond  when taking still images. When zoom is increased beyond the  position, interpolation is initiated and the zoom indicator turns yellow to indicate that interpolation is being applied. The position of  moves to the right as image size decreases, allowing for confirmation of the zoom positions at which shooting without interpolation is possible at the current image mode setting.



- Digital zoom can be disabled from the **Digital zoom** option (📖 160) in the setup menu (📖 149).

## Step 3 Focus and Shoot

### 1 Press the shutter-release button halfway.

When the shutter-release button is pressed halfway (📖 7), the camera sets focus and exposure (shutter speed and aperture value).

Focus and exposure remain locked while the shutter-release button is pressed halfway.

When a face is detected, it is framed by the double border indicating the active focus area. When the subject is in focus, the double border turns green.

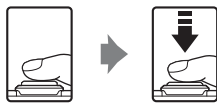

Shutter Speed Aperture

If the camera does not detect any faces, the camera selects the focus areas (up to nine areas) containing the subject closest to the camera. When the subject is in focus, the focus area that is selected is displayed in green.

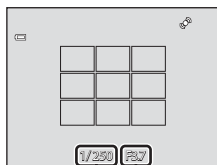

Shutter Speed Aperture

When digital zoom is used, the focus area is not displayed and the camera focuses at the center of the frame. Once focus has been acquired, the focus indicator will glow green.

If the focus area or the focus indicator blinks red when the shutter-release button is pressed halfway, the camera is unable to focus. Modify the composition and press the shutter-release button halfway again.

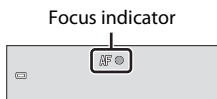

Focus Indicator

### 2 Press the shutter-release button the rest of the way down.

The shutter is released and the image will be saved to the memory card or internal memory.



### ✔ During Saving

While images are being saved, the number of exposures remaining will blink. **Do not open the battery-chamber/memory card slot cover** while images are being saved. Cutting power or removing the memory card in these circumstances could result in loss of data or in damage to the camera or card.

### ✔ Autofocus

Autofocus may not perform as expected in the following situations. In some rare cases, the subject may not be in focus despite the fact that the focus area or the focus indicator glows green.

- Subject is very dark
- Objects of sharply differing brightness are included in the scene (e.g. the sun behind the subject makes that subject appear very dark)
- No contrast between the subject and surroundings (e.g. a portrait subject, wearing a white shirt, is standing in front of a white wall)
- Several objects are at different distances from the camera (e.g. the subject is inside a cage)
- Regular geometric patterns (e.g. window blind or windows in a skyscraper)
- Subject is moving rapidly

In the situations noted above, try pressing the shutter-release button halfway to refocus several times, or focus on another subject (📖 54). When focusing on another subject, be sure that the alternate subject is at the same distance from the camera as the intended subject while the shutter-release button is pressed halfway.

### ✔ Note on Face detection

See “Notes on the Face Detection Function” (📖 42) for more information.

### ✔ When the Subject Is Close to the Camera

If the camera cannot focus, try shooting with macro mode (📖 39) or the **Close-up** scene mode (📖 68).

### ✎ Touch Shutter

At the default setting, the shutter can be released by simply tapping a subject in the monitor (📖 47) without pressing the shutter-release button. The **Touch shutter** option can be changed to the **Touch AF/AE** option, which allows the camera to set the focus and exposure on the subject that is tapped on the monitor. When using the **Touch AF/AE** option, the picture is taken by pressing the shutter-release button (📖 52).

### ✎ AF-assist Illuminator and Flash

If the subject is poorly lit, the AF-assist illuminator (📖 160) may light when the shutter-release button is pressed halfway, or the flash (📖 34) may fire when the shutter-release button is pressed all the way down.

## Step 4 Playing Back and Deleting Images

### Playing Back Images (Playback Mode)

Press the  (playback) button.

● (movie-record) button

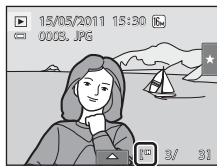
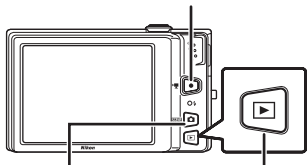

 (shooting mode) button

 (playback) button

Internal memory indicator

The last image captured will be displayed in full-frame playback mode.

Drag the current image left or right to display the previous or next image. Drag your finger quickly across half of the monitor or more to skip past the previous or subsequent five images. Tap the monitor to stop at an image as it slides past.

Display the previous image

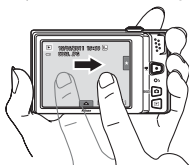

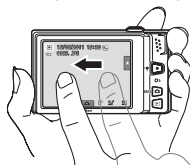

Display the next image



Images may be displayed briefly at low resolution while being read from the memory card or internal memory.

Press the  button, ● (movie-record) button, or shutter-release button to switch to shooting mode.

When playing back images saved in the camera's internal memory,  is displayed. When a memory card is inserted in the camera,  is not displayed and images saved on the memory card are played back.

#### When the Monitor Has Turned Off to Save Power

When the power-on lamp is blinking, press the power switch, shutter-release button,  button, or ● (movie-record) button to turn the monitor back on (162).

#### Operations Available in Playback Mode

See "More on Playback" (82) or "Editing Images" (113) for more information.

#### Pressing the Button to Turn On the Camera

When the camera is off, holding down the  button will turn the camera on in playback mode. The lens will not extend.

#### Viewing Images

Images captured using face detection (42) or pet detection (71) function will be rotated and displayed automatically according to the orientation of the faces detected, in full-frame playback mode (except images captured using **Subject tracking** (50), **Continuous, BSS**, and **Multi-shot 16**; (56, 71).

## Deleting Unwanted Images

- 1 Play back an image to be deleted, tap the bottom tab to display the setting controls (📖 14), and tap 🗑️.



- 2 Tap the desired delete option.

**Current image:** Delete the currently displayed full-frame image or movie (📖 133).

**Erase selected images:** Select multiple images and delete them. See “Operating the Erase Selected Images Screen” for more information.

**All images:** Delete all images.

Select either **Erase selected images** or **All images** when performing step 1 in thumbnail playback mode (📖 83).

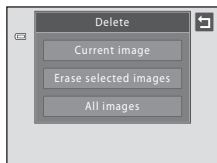

- 3 Tap **Yes** on the delete confirmation dialog.

Deleted images cannot be recovered.

To exit without deleting the image, tap **No** or **No**.

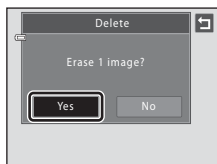

## Operating the Erase Selected Images Screen

- 1 Tap an image to display ✓.

To deselect the image, tap the image again and ✓ will be hidden.

Tap **⏮** or **⏭** to display previous or next page.

Tap **🔍** or **🔍**, or rotate the zoom control to **T** or **W** to change the number of images displayed.



- 2 Display ✓ to all images to delete and tap **OK** to apply the selection.

The confirmation screen is displayed. Follow the on-screen instructions for more operations.

### ✓ Notes on Deletion

- Once deleted, images cannot be recovered. Transfer important images to a computer before deleting them.
- Protected images cannot be deleted (📖 104).

# Using the Basic Shooting Functions

## ⚡ Flash Mode

Flash mode can be selected to suit the shooting conditions. When **ISO sensitivity** is set to **Auto**, the flash has a range of 0.5–4.5 m (1 ft. 8 in.–14 ft.) at the maximum wide-angle zoom position and a range of 1.1–2.4 m (3 ft. 8 in.–7 ft. 10 in.) at the maximum telephoto zoom position.



Auto

Flash fires automatically when lighting is poor.



Auto with red-eye reduction

Reduce “red-eye” in portraits (📖 36).



Off

Flash will not fire even when lighting is poor.



Fill flash

Flash fires whenever a picture is taken. Use to “fill-in” (illuminate) shadows and backlit subjects.



Slow sync

 (auto) is combined with slow shutter speed. Suited to evening and night portraits that include background scenery. Flash illuminates main subject; slow shutter speeds are used to capture background at night or under dim lighting.

## Setting the Flash Mode

- 1 Tap the left tab to display the setting controls (📖 14) and tap the flash mode icon.



- 2 Tap the desired flash mode icon.

Tap  to return to the previous screen.

To hide the setting controls after applying the setting, tap the tab again.

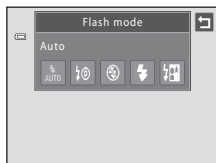

## ✓ Shooting When the Flash is Disabled (🚫) or Lighting is Dim

- Use of a tripod is recommended. Set **Vibration reduction** (📖 158) to **Off** in the setup menu (📖 149) when using a tripod to stabilize the camera during shooting.
- The noise reduction function may be activated with some shooting conditions such as dim lighting. More time than usual is required to save images to which noise reduction is applied.

## ✓ Note on Using the Flash

When using the flash, reflections from dust particles in the air may appear as bright spots in images. To reduce these reflections, set the flash to 🚫 (off).

## 📎 The Flash Lamp

The flash lamp indicates flash status when the shutter-release button is pressed halfway.

- On: Flash will fire when a picture is taken.
- Blinks: Flash charging. Wait a few seconds and try again.
- Off: Flash will not fire when a picture is taken.

If the battery is low, the monitor display will turn off, and remain off, until the flash is fully charged.

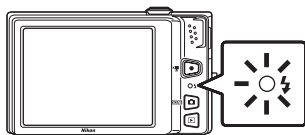

## 📎 The Flash Mode Setting

The default flash mode setting varies with shooting mode (📖 41).

- 📷 (auto) mode: 📷 (auto)
- Scene: varies with the selected scene mode (📖 60)
- 📷 (smart portrait): fixed at 📷 (auto) when **Off** is selected for **Blink proof**; 🚫 (off) when **On** is selected for **Blink proof** (📖 79)
- There are functions with which the flash cannot be enabled. See “Camera Settings That Cannot Be Applied Simultaneously” (📖 80) for more information.
- The flash mode setting applied in 📷 (auto) mode is saved in the camera’s memory even after the camera is turned off.

### **Red-eye Reduction**

This camera uses advanced red-eye reduction ("In-Camera Red-Eye Fix").

If the camera detects red-eye when a picture is taken, the affected area is processed to reduce red-eye before the image is saved.

Note the following when shooting:

- More time than usual is required to save images.
- Red-eye reduction may not produce the desired results in some situations.
- In extremely rare instances, areas not subject to red-eye may be affected by red-eye reduction processing; in these cases, choose another flash mode and try again.



## 🕒 Taking Pictures with the Self-timer

The camera is equipped with a ten-second and two-second timer for self-portraits. This feature is useful for reducing the effects of camera shake that occurs when pressing the shutter-release button. When using the self-timer, use of a tripod is recommended. Set **Vibration reduction** (📖 158) to **Off** in the setup menu (📖 149) when using a tripod to stabilize the camera during shooting.

- 1 Tap the left tab to display the setting controls (📖 14) and tap the self-timer icon.

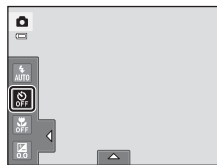

- 2 Tap **10s** or **2s**.

**10s** (ten seconds): Use on important occasions, such as weddings

**2s** (two seconds): Use to prevent camera shake

The mode selected for self-timer is displayed.

Tap 🏠 to return to the previous screen.

To hide the setting controls after applying the setting, tap the tab again.

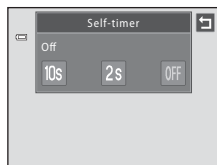

- 3 Frame the picture and press the shutter-release button halfway.

Focus and exposure will be set.

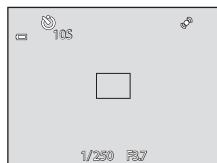

#### 4 Press the shutter-release button the rest of the way down.

The self-timer starts, and the number of seconds remaining before the shutter is released is displayed in the monitor. The self-timer lamp blinks while the timer is counting down. About one second before the shutter is released, the lamp stops blinking and glows steadily.

When the shutter is released, the self-timer will be set to **Off**.

To stop the timer before a picture is taken, press the shutter-release button again.

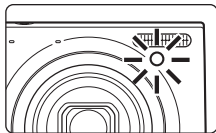
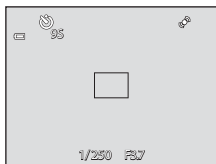

#### Note on Self-timer

There are functions with which this setting cannot be enabled. See “Camera Settings That Cannot Be Applied Simultaneously” (📖 80) for more information.

## Macro Mode

Macro mode is used for taking pictures of objects as close as 3 cm (1.2 in.). Note that the flash may be unable to light the entire subject at distances of less than 50 cm (1 ft. 8 in.).

- 1 Tap the left tab to display the setting controls ( 14) and tap the macro mode icon.

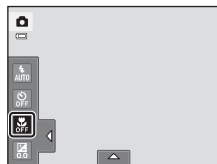



- 2 Tap **ON**.

Tap  to return to the previous screen.

To hide the setting controls after applying the setting, tap the tab again.



- 3 Rotate the zoom control to the zoom position at which  and the zoom indicator glow green.

The closest possible shooting distance may vary according to the zoom position. In the zoom position where the  icon and zoom indicator glow green (near the  icon), the camera can focus on subjects as close as 3 cm (1.2 in.) from the lens.



### Note on Macro Mode Setting

There are functions with which this setting cannot be enabled. See “Camera Settings That Cannot Be Applied Simultaneously” ( 80) for more information.

### Autofocus

When taking still pictures in macro mode, the camera continuously adjusts the focus until the shutter-release button is pressed halfway to lock the focus. The sound of the camera focusing can be heard.

### The Macro Mode Setting

When using  (auto) mode, the macro mode setting is saved in the camera’s memory even if the camera is turned off.

## Changing the Brightness Using Exposure Compensation

Exposure compensation is used to alter exposure from the value suggested by the camera to make images brighter or darker.

- 1 Tap the left tab to display the setting controls ( 14) and tap the exposure compensation icon.

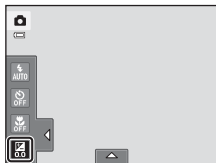

- 2 Drag the slider to change the exposure compensation value.

To make the image brighter, apply positive (+) exposure compensation.

To make the image darker, apply negative (-) exposure compensation.

Tap  to return to the previous screen.

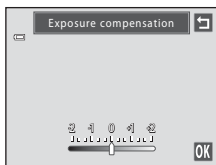

- 3 Tap **OK**.

To hide the setting controls after applying the setting, tap the tab again.

To exit without setting the exposure compensation, set the value to **0** and tap **OK**.

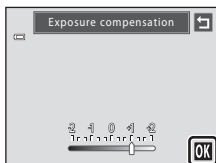

### Exposure Compensation Value

The exposure compensation value applied in  (auto) mode is saved in the camera's memory even after the camera is turned off.

## Selecting a Shooting Mode

Following shooting modes can be selected.



### Auto mode

26

Pictures can be taken with an automatic, point-and-shoot mode recommended for first-time users of digital cameras. Pictures can be taken with the flash mode or macro mode settings. Other settings can be made, such as the continuous setting or the “subject tracking” option, which moves the active focus area to track the registered subject.



### Scene mode

59

Camera settings are automatically optimized for the selected scene. In scene auto selector mode, the camera automatically selects the optimum scene mode for simpler shooting.



### Smart portrait mode

76

The camera uses the face detection function to detect human faces, and automatically releases the shutter when a smile is detected. The skin softening option can be used to make skin tones of human faces displayed smoothly.

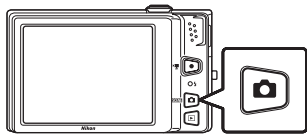

## 1 Press the button in shooting mode.

The shooting-mode selection menu is displayed.



## 2 Tap the desired shooting mode icon.

The camera enters the selected shooting mode.

To select a scene mode, first tap  (scene), and then tap the icon of the desired scene mode ( 59).

To return to the current shooting mode without switching shooting modes, press the  button or the shutter-release button.

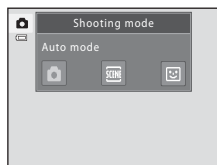

### Face Detection

In the following shooting modes, when the camera is pointed at a person's face, the camera detects the face and focuses on it. When more than one face is detected, the face that is focused on is framed by a double border indicating the active focus area, and faces outside of the active focus area are framed by a single border.



Shooting mode	Number of faces that can be detected	Focus area (double border)
📷 (auto) mode (📖 26)	Up to 12	The face closest to the camera
<b>Scene auto selector, Portrait, Night portrait</b> scene mode (📖 59)	Up to 12	The face closest to the camera
Smart portrait mode (📖 76)	Up to 3	The face closest to the center of the frame

- If no faces are detected when the shutter-release button is pressed halfway in 📷 (auto) mode, the camera automatically selects one or more of the nine focus areas containing the subject closest to the camera.
- When using **Scene auto selector**, the focus area varies depending on the scene mode selected by the camera.
- If no faces are detected when the shutter-release button is pressed halfway in the **Portrait** and **Night portrait** scene modes or in smart portrait mode, the camera will focus on the subject at the center of the frame.
- Tap the face framed by a single border to change the focus area to that face (📖 47, 52)
- When using subject tracking (📖 50), tap a face that was detected by the camera and framed by a border to begin tracking that face

### ✔ Notes on the Face Detection Function

- The camera may be unable to detect faces in the following situations:
  - When faces are partially hidden by sunglasses or other obstructions
  - When faces take up too much or too little of the frame
- When the frame includes more than one face, the faces detected by the camera and the face on which the camera focuses depend upon a variety of factors, including the direction in which the faces are looking.
- In some cases, including those noted in "Autofocus" (📖 31), autofocus may not perform as expected, and the subject may not be in focus despite the fact that the double border glows green. Should this occur, refocus on another subject positioned at the same distance from the camera as the actual portrait subject (📖 54).

## Viewing Images That Were Captured Using Face Detection

- Depending on the orientation of the face, images may be automatically rotated during playback (except images captured with **Subject tracking** (📖 50), **Continuous, BSS**, or **Multi-shot 16**; 📖 56).
- Rotate the zoom control to **T** (📖 86) in full-frame playback mode to zoom in on the face detected at the time of shooting (📖 86) (except images captured with **Subject tracking** (📖 50), **Continuous, BSS**, or **Multi-shot 16**; 📖 56).







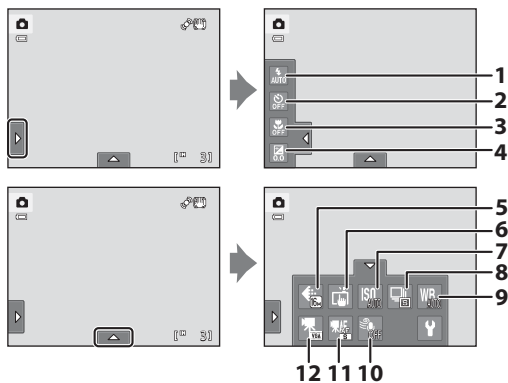

## Adjusting the (Auto) Mode setting





In  (auto) mode, the camera settings indicated below can be adjusted by tapping the tabs to display the setting controls.

- Each icon also indicates the current setting.
- Tap the icon of the desired item to display the setting screen for that item.
- Tap the tab again to hide the setting controls.

The settings applied in  (auto) mode are saved in the camera's memory even after the camera is turned off (except for self-timer).



<b>1</b>	 Flash mode <sup>1</sup> .....	34
<b>2</b>	 Self-timer <sup>1</sup> .....	37
<b>3</b>	 Macro mode <sup>2</sup> .....	39
<b>4</b>	 Exposure compensation <sup>1</sup> .....	40
<b>5</b>	 Image mode <sup>1</sup> .....	45
Touch shooting		
<b>6</b>	 Touch shutter <sup>1</sup> .....	47
	 Subject tracking.....	50
	 Touch AF/AE <sup>1</sup> .....	52

<b>7</b>	<b>ISO</b> ISO sensitivity.....	55
<b>8</b>	 Continuous.....	56
<b>9</b>	<b>WB</b> White balance.....	57
<b>10</b>	 Wind noise reduction.....	132
<b>11</b>	 Movie AF mode <sup>1</sup> .....	131
<b>12</b>	 Movie options <sup>1</sup> .....	130

<sup>1</sup> Available for some scene modes (📖 59) and smart portrait mode (📖 76)

<sup>2</sup> Available for some scene modes (📖 59)

### Camera Settings That Cannot Be Applied Simultaneously













Some shooting settings cannot be used with other functions. See “Camera Settings That Cannot Be Applied Simultaneously” (📖 80) for more information.





## Image Mode (Changing Image Quality/Image Size)

 (auto) → Tap the bottom tab → Image mode

Image mode refers to the combination of image size and image quality (compression) at which images are saved. Choose the image mode best suited to the manner in which images will be used and the capacity of the internal memory or memory card. The higher the image mode setting, the larger the size at which it can be printed or displayed without appearing noticeably “grainy,” but limiting the number of images that can be saved.









Option	Size (pixels)	Description
 4608×3456★	4608 × 3456	Higher quality than  suitable for enlargements or high-quality prints. The compression ratio is approximately 1:4.
 4608×3456 (default setting)	4608 × 3456	Best choice in most situations. The compression ratio is approximately 1:8.
 3264×2448	3264 × 2448	
 2592×1944	2592 × 1944	
 2048×1536	2048 × 1536	Smaller size than  ,  , or  allows more images to be saved. The compression ratio is approximately 1:8.
 1024×768	1024 × 768	Suited to display on a computer monitor. The compression ratio is approximately 1:8.
 640×480	640 × 480	Suited to full-screen display on a television with an aspect ratio of 4:3, or distribution by e-mail. The compression ratio is approximately 1:8.
 4608×2592	4608 × 2592	Images with an aspect ratio of 16:9 are saved. The compression ratio is approximately 1:8.

### Image Mode

- To change the image mode setting when using shooting modes other than  (auto) mode, tap the bottom tab to display the setting controls and tap .
- Change made to this setting applies to all shooting modes.
- There are functions with which this setting cannot be enabled. See “Camera Settings That Cannot Be Applied Simultaneously” (📖 80) for more information.

 **Number of Exposures Remaining**





The following table lists the approximate number of images that can be saved in internal memory and on a 4 GB memory card. Note that the number of images that can be saved will differ depending on the composition of the image (due to JPEG compression). In addition, this number may vary depending on the make of memory card, even when the memory cards have the same specified capacity.

Setting	Internal memory (approx. 20 MB)	Memory card (4 GB)	Print size* (cm/in.)
 4608×3456★	1	620	39 × 29/15 × 11.5
 4608×3456	3	1060	39 × 29/15 × 11.5
 3264×2448	7	2050	28 × 21/11 × 8
 2592×1944	12	3240	22 × 16/8.5 × 6.5
 2048×1536	20	5120	17 × 13/7 × 5
 1024×768	65	16400	9 × 7/3.5 × 2.5
 640×480	108	24100	5 × 4/2 × 1.5
 4608×2592	5	1380	39 × 22/15 × 8.5

\* Print size at an output resolution of 300 dpi. Print sizes are calculated by dividing the number of pixels by printer resolution (dpi) and multiplying by 2.54 cm (1 in.). However, at the same image size, images printed at higher resolutions will print smaller than the size indicated, and those printed at lower resolutions will print larger than the size indicated.





- The number of exposures remaining is displayed on the shooting screen when 50 or fewer remain ( 26).
- If there are 10,000 or more images saved in the camera, "9999" is displayed on the playback screen as the current frame number or total number of frames.

## Touch Shutter (Tapping the Monitor to Release the Shutter)

 (auto) → Tap the bottom tab →  /  /  Touch shooting

Pictures can be taken by simply tapping the monitor.

- **Touch shutter** is set by default. Proceed to step 2.

- 1 Tap the bottom tab, tap  /  /  (  44 ), and then tap .

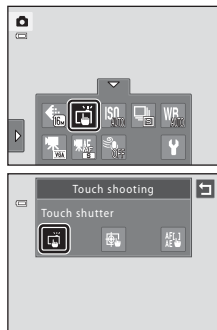



- 2 Tap the desired subject to take a picture.

Do not use force when tapping the monitor as this may cause slight movement of the camera, resulting in blurred images.





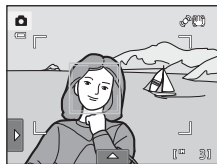
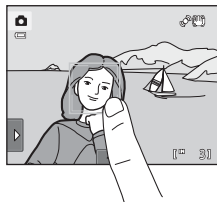

When digital zoom is in effect, the camera focuses on the subject in the center of the frame.

The shutter-release button can also be used when the touch shutter option is selected.

If  is displayed when the monitor is tapped, the shutter cannot be released. Tap an area within  or a border displayed when the camera detects a face.













### Notes on Touch Shutter

- When taking pictures with **Continuous** or **BSS** in **Continuous** setting ( 56) enabled, or in **Sports** or **Museum** scene mode ( 59), use the shutter-release button to take pictures. Only one image can be captured at a time using the touch shutter function.
- Prevent shooting with accidental tapping of the monitor in  (auto) mode and some scene modes by changing the touch shooting setting to **Touch AF/AE** ( 52). At this setting, the shutter is not released when the monitor is tapped.
- When shooting subjects with which autofocus may not perform as expected, the subject may not be in focus ( 31).
- When a subject displayed in the monitor is tapped with the self-timer ( 37) enabled, the camera locks focus and releases the shutter after ten or two seconds.
- There are functions with which this setting cannot be enabled. See “Camera Settings That Cannot Be Applied Simultaneously” ( 80) for more information.

 **Shooting Modes That Support Touch Shutter**

The touch shutter can be used in  (auto) mode and other shooting modes. Touch shutter operation differs according to the current shooting mode as follows.

Shooting mode	Touch shutter operation
 (auto) mode (  26), <b>Sports, Party/indoor, Beach, Snow, Close-up, Food, Museum, Black and white copy, and Backlighting</b> scene modes (  59)	Tap the intended subject. Focus and exposure are set for the area tapped. When the camera detects more than one face, tap a face framed by a single border to set focus and exposure for that face.
<b>Scene auto selector</b> scene mode (  59), smart portrait mode (when <b>Smile timer</b> is set to <b>Off</b> ;  76)	<ul style="list-style-type: none"> <li>• When a face is detected by the camera, it is framed by a border. Tap a detected face to set the focus and exposure on that face.</li> <li>• When no face is detected, the camera focuses at the area tapped.</li> </ul>
<b>Portrait and Night portrait</b> scene modes (  59)	Only a border displayed by the face detection function can be selected. When the camera detects more than one face, tap a face framed by a single border to set focus and exposure for that face.
<b>Landscape, Sunset, Dusk/dawn, Night landscape, Fireworks show, and Panorama assist</b> scene modes (  59)	Focus and exposure are set for the same focus area used when pictures are taken by pressing the shutter-release button. See “Selecting a Scene Mode to Take Pictures (Features)” (  64) for more information.
Smart portrait mode (when <b>Smile timer</b> is set to <b>On</b> ) (  76)	Touch shutter cannot be enabled. When the camera detects more than one face, tap a face framed by a single border to move the focus area to that face.
<b>Pet portrait</b> scene mode (  59)	Tap the intended subject. Focus and exposure are set for the area tapped. However, if the camera detects a pet when pet portrait auto release is set to <b>On</b> , the camera focuses on the detected face and releases the shutter automatically.

## Subject Tracking (Focusing on a Moving Subject)

(auto) → Tap the bottom tab → / / Touch shooting

In (auto) mode ( 26), the touch shooting setting can be changed from **Touch shutter** (default setting) to **Subject tracking**. Use this option to take pictures of moving subjects. Tap the subject on which the camera will focus. The focus area will automatically move to track the subject.

- 1 Tap the bottom tab, tap / / ( 44), and then tap (**Subject tracking**).  
 (subject tracking) is enabled only in (auto) mode.



## 2 Register a subject.

Tap the desired tracking subject in the monitor.

- The subject is registered.
- When a face is detected by the camera, tap a face framed by a border to register the face and begin tracking the subject. If multiple faces were detected, all borders disappear except for the border framing the registered face.
- When the subject registered is not a face, a yellow focus area is displayed around that subject and the camera begins tracking the subject.
- When the border framing the subject glows red, the camera is unable to focus. Change the composition and try again.

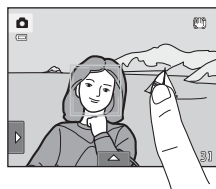

If the tapped area does not contain a subject that can be registered, is displayed in the monitor. Tap a subject within .

Tap another subject to change a subject to follow.

To cancel the registration of the subject, tap , displayed at left in the monitor.

If the camera cannot track the registered subject anymore, the focus area will disappear and the registration will be canceled. Register the subject again.



### 3 Press the shutter-release button to take a picture.

The camera focuses on the focus area when the shutter-release button is pressed halfway. The focus area will glow green and focus will be locked.





When the camera is unable to focus, the focus area will blink. Press the shutter-release button halfway again to focus.

If the shutter-release button is pressed halfway while the focus area is not displayed, the camera will focus on the subject at the center of the frame.

Press the shutter-release button all the way down to release the shutter.



### Notes on Subject Tracking Mode

- Digital zoom is not available.
- The sound of the camera focusing can be heard when the subject tracking function is working.
- Adjust zoom position and apply shooting settings ( 44) before registering the subject. If these settings are adjusted after the subject has been registered, subject registration will be canceled.
- It may be impossible to register the desired subject, or the camera may be unable to track the registered subject or may begin tracking a different subject, if the subject is moving rapidly, if there is a significant amount of camera shake, or if the camera detects a similar subject. The camera's ability to accurately track the registered subject is also dependent upon the size and brightness of the subject.
- In some rare cases, subjects with which autofocus may not perform as expected ( 31) may be out of focus despite the fact that the focus area glows green. In this situation, focus on another subject which is at the same distance from the camera as the intended subject while the shutter-release button is pressed halfway ( 54).
- There are functions with which this setting cannot be enabled. See "Camera Settings That Cannot Be Applied Simultaneously" ( 80) for more information.

### Touch Shooting Setting

Subject registration with subject tracking will be canceled when the camera is turned off.

## **Touch AF/AE (Tapping the Monitor to Focus)**

(auto) → Tap the bottom tab → /Touch shooting

The touch shooting setting can be changed from **Touch shutter** (default setting) to **Touch AF/AE**.

Tap a subject in the monitor to select the area at which the camera focuses. Press the shutter-release button halfway to lock focus and exposure for the area tapped, and press the shutter-release button the rest of the way down to take the picture.

- 1 Tap the bottom tab, tap /Touch shooting (book 44), and then tap (touch AF/AE).



- 2 Tap the subject at which the camera focuses.

or a double border will be displayed at the area tapped.

When digital zoom is applied, the focus area cannot be selected.

To cancel the focus area selection, tap displayed at left in the monitor.

If a position at which focus cannot be acquired is tapped, will be displayed in the monitor. Tap another position inside .

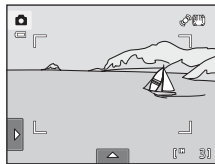



### 3 Press the shutter-release button to take a picture.

Press the shutter-release button halfway to acquire focus and exposure and press it all the way down to release the shutter.













#### **Note on Touch AF/AE**

When shooting subjects with which autofocus may not perform as expected, the subject may not be in focus ( 31).

#### **Shooting Modes That Enable Touch AF/AE Function**

Touch AF/AE can be used in  (auto) mode and other shooting modes. Touch AF/AE operation differs according to the current shooting mode as follows.

Shooting mode	Touch AF/AE operation
 (auto) mode (  , <b>Sports, Party/indoor, Beach, Snow, Close-up, Food, Museum, Black and white copy, and Backlighting</b> scene modes ( 	Focus and exposure are set for the area tapped.
<b>Scene auto selector</b> scene mode (  , smart portrait mode (when <b>Smile timer</b> is set to <b>Off</b> ; 	<ul style="list-style-type: none"> <li>When the camera detects a face, only a face framed by a border can be selected. When the camera detects more than one face, tap a face framed by a single border to move the focus area to that face.</li> <li>When no face is detected, the camera focuses at the area tapped.</li> </ul>
<b>Portrait</b> and <b>Night portrait</b> scene modes (  , smart portrait mode (when <b>Smile timer</b> is set to <b>On</b> ; 	Only a border displayed by the face detection function can be selected. When the camera detects more than one face, tap a face framed by a single border to move the focus area to that face.
<b>Landscape, Sunset, Dusk/dawn, Night landscape, Fireworks show, and Panorama assist</b> scene modes ( 	The focus area cannot be changed.
<b>Pet portrait</b> scene mode ( 	When pet portrait auto release (  ) is set to <b>Off</b> , touch shutter (default setting) and touch AF/AE can be selected. When touch AF/AE is selected, focus and exposure are set for the area tapped. However, if the camera detects a pet when pet portrait auto release is set to <b>On</b> with touch AF/AE still selected, the camera focuses on the detected face and releases the shutter automatically.

### **Taking Pictures of Subjects with Which Autofocus may not Perform as Expected**

When taking pictures of subjects with which autofocus may not perform as expected ( 31), try pressing the shutter-release button halfway to refocus several times, or try the following techniques.

- 1 Switch to  (auto) mode and select **Touch AF/AE** for the touch shooting setting.
- 2 Tap another subject that is as far from the camera as the desired subject.
- 3 Press the shutter-release button halfway.
  - The camera focuses on the subject and the focus area glows green.
  - Exposure is locked for the subject on which focus is acquired when the shutter-release button is pressed halfway.
- 4 Continue holding down the shutter-release button halfway and recompose the picture.
  - Be sure to maintain the same distance between the camera and the subject while the shutter-release button is pressed halfway.
- 5 Press the shutter-release button the rest of the way down to take the picture.

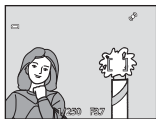
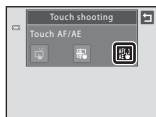

## ISO ISO Sensitivity

 (auto) → Tap the bottom tab → **ISO** ISO sensitivity

The higher the sensitivity, the less light is needed to expose an image, allowing capturing darker subjects.

Also, a higher sensitivity allows higher shutter speeds, resulting in the image with less camera shake and subject blur in comparison to the same subject taken under the same brightness.

- Although high ISO sensitivity settings are suited to images of subjects captured under dim lighting, those captured without flash, or those captured at telephoto setting, high sensitivity settings are often associated with “noise”- randomly spaced, brightly colored pixels- concentrated in dark portions of images.

### **AUTO** Auto (default setting)

Sensitivity is ISO 80 under normal conditions; when lighting is poor, the camera compensates by raising sensitivity to a maximum of ISO 1600.



### Fixed range auto

Choose the range in which the camera automatically adjusts ISO sensitivity, from **ISO 80-400** or **ISO 80-800**. The camera will not increase sensitivity beyond the maximum value in the selected range. Set the maximum value for ISO sensitivity for effective control over the amount of “grain” that appears in images.

**80, 100, 200, 400, 800, 1600, 3200**

Sensitivity is locked at the specified value.

## **Notes on ISO Sensitivity**

- There are functions with which this setting cannot be enabled. See “Camera Settings That Cannot Be Applied Simultaneously” ( 80) for more information.
- When the ISO sensitivity setting is set to any option other than **Auto, Motion detection** ( 159) is disabled.

## Continuous

 (auto) → Tap the bottom tab →  Continuous

Enable continuous shooting or BSS (best shot selector).

### Single (default setting)

One image is captured each time the shutter-release button is pressed.

### Continuous

While the shutter-release button is held down, about two images are captured at a rate of up to about 1.2 frames per second (at an image mode setting of  **4608×3456**).

### **BSS** BSS (Best Shot Selector)

The “best shot selector” is recommended when shooting with the flash off or the camera zoomed in, or in other situations in which inadvertent motion can result in blurred images. When BSS is on, the camera shoots up to ten images while the shutter-release button is held down. The sharpest image in the series is automatically selected and saved.

### Multi-shot 16

Each time the shutter-release button is pressed, the camera takes 16 shots at a rate of about 30 fps and arranges them in a single image.

Images are saved at an image mode setting of  (image size: 2560 × 1920 pixels). This setting cannot be changed.

Digital zoom is not available.

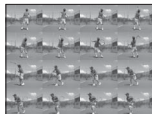

## Notes on Continuous Shooting

- When **Continuous**, **BSS**, or **Multi-shot 16** is selected, the flash is disabled. Focus, exposure, and white balance are fixed at the values determined with the first image in each series.
- The frame rate with continuous shooting may vary depending upon the current image mode setting, the memory card used, or shooting condition.
- There are functions with which this setting cannot be enabled. See “Camera Settings That Cannot Be Applied Simultaneously” ( 80) for more information.

## Note on BSS

**BSS** is effective when taking pictures of still subjects. BSS may not produce the desired results if the subject moves or the composition changes while the shutter-release button is held down.

## Note on Multi-shot 16

Smear ( 175) visible in the monitor when shooting with **Multi-shot 16** enabled will be saved with images. Avoiding bright objects such as the sun, reflections of the sun, and electric lights when shooting with **Multi-shot 16** enabled is recommended.

## WB White Balance (Adjusting Hue)

 (auto) → Tap the bottom tab → WB White balance

The color of light reflected from an object varies with the color of the light source. The human brain is able to adapt to changes in the color of the light source, with the result that white objects appear white whether seen in the shade, direct sunlight, or under incandescent lighting. Digital cameras can mimic this adjustment by processing images according to the color of the light source. This is known as “white balance.” For natural colors, choose a white balance setting that matches the light source before shooting. Although the default setting, **Auto**, can be used under most types of lighting, the white balance setting suited to a particular light source can be specified manually to achieve more accurate results.

### Auto (default setting)

White balance automatically adjusted to suit lighting conditions. Best choice in most situations.

### Preset manual

Neutral-colored object used as reference to set white balance under unusual lighting conditions. See “Preset Manual” ( 58) for more information.

### Daylight

White balance adjusted for direct sunlight.

### Incandescent

Use under incandescent lighting.

### Fluorescent

Use under fluorescent lighting.

### Cloudy

Use when taking pictures under overcast skies.

### Flash

Use with the flash.

### Note on White Balance

At white-balance settings other than **Auto** or **Flash**, turn the flash off () ( 34).

## Preset Manual

Preset manual is used with mixed lighting or to compensate for light sources with a strong color cast when the desired effect has not been achieved with white balance settings like **Auto** and **Incandescent** (for example, to make images shot under a lamp with a red shade look as though they had been shot under white light).

Follow the procedure below to measure the white balance value according to the light source when shooting.

**1** Place a white or gray reference object under the lighting that will be used during shooting.

**2** Tap the bottom tab to display the setting controls ( 14) and tap **WB**.



**3** Tap **PRE**.

The camera zooms in to the position for measuring white balance.

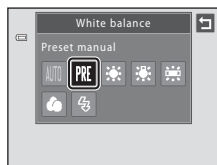

**4** Frame the reference object in the measuring window.

To apply the most recently measured value for preset manual, tap **Cancel**.

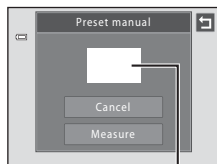

Measuring window

**5** Tap **Measure** to measure a value for preset manual.

The shutter is released and the new white balance value is set. No image is saved.

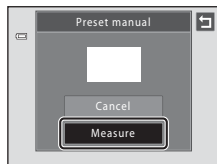

### **Note on Preset Manual**

A value for flash lighting cannot be measured with **Preset manual**. When shooting using the flash, set **White balance** to **Auto** or **Flash**.

# Shooting Suited to Scenes (Scene Mode)

Camera settings are automatically optimized for the selected subject type. The following scene modes are available.

Scene auto selector	Portrait	Landscape	Sports	Night portrait
Party/indoor	Beach	Snow	Sunset	Dusk/dawn
Night landscape	Close-up	Food	Museum	Fireworks show
Black and white copy	Draw	Backlighting	Panorama assist	Pet portrait

## Selecting a Scene Mode

- 1 Press the button in shooting mode and tap .

The scene mode selection screen is displayed.

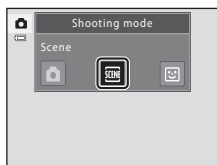
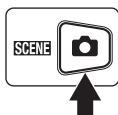

- 2 Tap the desired scene icon.

The display changes to that for the selected scene mode.

For more information about features of scene modes, see page 64.



- 3 Frame the subject and take a picture.

The degree of effects can be adjusted with the scene effect adjustment slider ( 61) depending on the scene mode.



## Displaying the Description of Each Scene Mode (Help)

In the scene selection screen (step 2), if is tapped the help selection screen is displayed. Tap a scene icon to display a description of the features of that mode. Tap to return to the help selection screen.









































- In the help selection screen, tap to return to the monitor display shown in step 2.



## Shooting Suited to Scenes (Scene Mode)

### Shooting Settings in Scene Mode

The shooting settings for each scene mode are shown below.

	Flash mode (📖 34)	Self-timer (📖 37)	Macro mode (📖 39)	Exposure compensation (📖 40)	Touch shooting (📖 47, 52)
	 <sup>1</sup> AUTO	Off <sup>2</sup>	- <sup>3</sup>	0 <sup>2</sup>	 <sup>2</sup>
	  <sup>2</sup>	Off <sup>2</sup>	Off	0 <sup>2</sup>	 <sup>2</sup>
	 	Off <sup>2</sup>	Off	0 <sup>2</sup>	
	  <sup>4</sup>	Off <sup>2</sup>	Off	0 <sup>2</sup>	 <sup>2</sup>
	  <sup>2, 5</sup>	Off <sup>2</sup>	Off	0 <sup>2</sup>	 <sup>2</sup>
	 <sup>2</sup> AUTO	Off <sup>2</sup>	Off	0 <sup>2</sup>	 <sup>2</sup>
	 <sup>2</sup> AUTO	Off <sup>2</sup>	Off	0 <sup>2</sup>	 <sup>2</sup>
	  <sup>2</sup>	Off <sup>2</sup>	Off	0 <sup>2</sup>	
	 	Off <sup>2</sup>	Off	0 <sup>2</sup>	
	 <sup>2</sup> AUTO	Off <sup>2</sup>	On	0 <sup>2</sup>	 <sup>2</sup>
	 	Off <sup>2</sup>	On	0 <sup>2</sup>	 <sup>2</sup>
	 	Off <sup>2</sup>	Off <sup>2</sup>	0 <sup>2</sup>	 <sup>2</sup>
	 	Off	Off	0	
	  <sup>2</sup>	Off <sup>2</sup>	Off <sup>2</sup>	0 <sup>2</sup>	 <sup>2</sup>
	-	-	-	-	-
	 	Off <sup>2</sup>	Off	0 <sup>2</sup>	 <sup>2</sup>
	  <sup>2</sup>	Off <sup>2</sup>	Off <sup>2</sup>	0 <sup>2</sup>	 <sup>2</sup>
	 	- <sup>6</sup>	Off <sup>2</sup>	0 <sup>2</sup>	 <sup>7</sup>

<sup>1</sup> The camera automatically selects the optimum flash mode setting for the scene mode it has selected (📖 63). Can be changed to  (off).

<sup>2</sup> The default setting can be changed by tapping the tabs to display the setting controls.

<sup>3</sup> The setting changes to macro mode when the camera selects close-up scene mode (📖 63).

<sup>4</sup> The flash mode setting is fixed at fill flash with slow sync with red-eye reduction.

<sup>5</sup> The setting may change to slow sync with red-eye reduction.

<sup>6</sup> Self-timer is not available. Pet portrait auto release can be set to **On** or **Off** (📖 71).

<sup>7</sup> When pet portrait auto release (📖 71) is set to **Off**, touch shutter (default setting) and touch AF/AE can be selected.

### Image Mode (Image Quality/Image Size) Setting

The image mode (📖 45) setting previously specified in other shooting modes applies. To change the image mode setting in scene mode, tap the bottom tab to display the setting controls and tap .





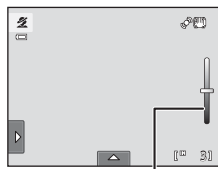

## Adjusting Scene Effect

The scene effect adjustment slider is displayed in the scene modes listed below. Tap or drag the scene effect adjustment slider to adjust the degree of effect to be applied to images captured in the selected scene mode.









Scene effect adjustment slider

Portrait,  Night portrait, Beach,  Snow, Night landscape,  Backlighting	 <p>Brighter</p> <p>Darker</p>
Food	 <p>More red</p> <p>More blue</p>
Landscape,  Close-up	 <p>More vivid</p> <p>Less vivid</p>
Sunset,  Dusk/dawn	 <p>More red</p> <p>More blue</p>

## Shooting in the Scene Mode Selected by the Camera (Scene Auto Selector)

By simply framing a picture, the camera automatically selects one of the following scene modes for simpler shooting.

- : Auto (general shooting)
- : Landscape
- : Night landscape
- : Backlighting
- : Portrait
- : Night portrait
- : Close-up

### 1 Press the button in shooting mode and tap .

The scene mode selection screen is displayed.

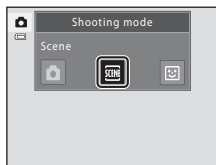
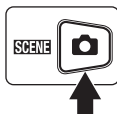

### 2 Tap (scene auto selector) scene mode ( 59).

The camera enters scene auto selector scene mode.



### 3 Frame the subject and take a picture.



The shooting mode icon changes to that for the scene mode currently enabled.

Press the shutter-release button halfway to set focus and exposure. When the subject is in focus, the active focus area glows green.



Press the shutter-release button the rest of the way down to take the picture.



## Notes on Scene Auto Selector Scene Mode





- Digital zoom is not available.
- Depending upon shooting conditions, the camera may not select the desired scene mode. Should this occur, switch to  (auto) mode ( 26) or select the desired scene mode manually ( 59).

### Focusing in Scene Auto Selector Scene Mode

- When the camera recognizes a human face in scene auto selector scene mode, it focuses on that face. See “Face Detection” (📖 42) for more information.
- When the shooting mode indicator  or  (close-up) is displayed, the camera automatically selects the focus area (up to nine areas) containing the subject closest to the camera.

### Functions Available in Scene Auto Selector Scene Mode

Tap the left tab or the bottom tab to display the setting controls and change settings for flash mode (📖 34), self-timer (📖 37), exposure compensation (📖 40), image mode (📖 45), and touch shooting (📖 47, 52).

-  (auto; default setting) and  (off) flash modes can be specified (📖 34). When  (auto) is applied, the camera automatically selects the optimum flash mode for the scene mode it has selected. When  (off) is applied, the flash does not fire, regardless of shooting conditions.
- Macro mode is disabled. Macro mode is only enabled when the camera selects Close-up scene mode.
- Changes made to these settings apply to all shooting modes.

## Selecting a Scene Mode to Take Pictures (Features)

See “Shooting in the Scene Mode Selected by the Camera (Scene Auto Selector)” (📖 62) for more information on scene auto selector.

### Portrait

Use this mode for portraits.

- When the camera detects a human face, that face will be framed by a yellow double border (focus area). See “Face Detection” (📖 42) for more information.
- If more than one face is detected, the face nearest to the camera will be framed by a yellow double border (focus area) and the other faces will be framed by a single border. Tap the face framed by a single border to change the focus area to that face (📖 47, 52).
- The camera softens skin tones (in up to three faces) by applying the skin softening function before saving images (📖 77).
- If no faces are detected when the shutter-release button is pressed halfway, the camera focuses on the subject at the center of the frame.
- Digital zoom is not available.
- The default setting for flash mode is  **Auto with red-eye reduction**.
- Use the scene effect adjustment slider (📖 61) to adjust image brightness.



### Landscape

Use this mode for vivid landscapes and cityscapes.



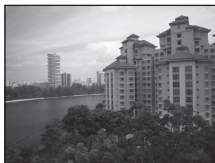

- The camera focuses at infinity. The focus area or focus indicator (📖 30) always glows green when the shutter-release button is pressed halfway. Note, however, that objects in the foreground may not always be in focus.
- Flash is disabled.
- AF-assist illuminator (📖 160) does not light.
- Use the scene effect adjustment slider (📖 61) to adjust image saturation.



Use of a tripod is recommended in scene modes with which  is indicated. Set **Vibration reduction** (📖 158) to **Off** when using a tripod to stabilize the camera.

### Sports

Use this mode for dynamic action shots that freeze the action in a single shot and save motion in a series of images.





- The camera focuses on the subject at the center of the frame. The area focused can be changed by the touch shutter ( 47) or touch AF/AE ( 52). The camera continuously adjusts the focus until the shutter-release button is pressed halfway to lock the focus.
- While the shutter-release button is held down, about two images are captured at a rate of up to about 1.2 frames per second (fps) when image mode is set to  **4608x3456**.
- Focus, exposure, and white balance are fixed at the values determined with the first image in each series.
- The maximum frame rate with continuous shooting may vary depending upon the current image mode setting, the memory card used, or shooting condition.
- Continuous shooting is disabled and only one image can be captured at a time when the shutter is released using the **Touch shutter** function ( 47).
- Flash is disabled.
- AF-assist illuminator ( 160) does not light.



### Night portrait



Use this mode for portraits taken at sunset or at night. The flash fires to light the portrait subject while preserving background lighting to achieve a natural balance between the main subject and background ambience.

- When the camera detects a human face, that face will be framed by a yellow double border (focus area). See “Face Detection” ( 42) for more information.
- If more than one face is detected, the face nearest to the camera will be framed by a yellow double border (focus area) and the other faces by a single border. Tap the face framed by a single border to change the focus area to that face ( 47, 52).
- The camera softens skin tones (in up to three faces) by applying the skin softening function before saving images ( 77).
- If no faces are detected when the shutter-release button is pressed halfway, the camera focuses on the subject at the center of the frame.
- Digital zoom is not available.
- The flash mode setting is fixed at fill flash with slow sync with red-eye reduction.
- Use the scene effect adjustment slider ( 61) to adjust image brightness.



## Shooting Suited to Scenes (Scene Mode)

### Party/indoor

Captures the effects of candlelight and other indoor background lighting.

- The camera focuses on the subject at the center of the frame. The area focused can be changed by the touch shutter (📖 47) or touch AF/AE (📖 52).
- The default setting for flash mode is  **Auto with red-eye reduction**. The flash mode setting may automatically switch to slow sync with red-eye reduction.
- As images are easily affected by camera shake, hold the camera steadily. Use of a tripod is recommended in dark surroundings. Set **Vibration reduction** (📖 158) to **Off** when using a tripod to stabilize the camera.



### Beach

Captures the brightness of such subjects as beaches or sunlit expanses of water.

- The camera focuses on the subject at the center of the frame. The area focused can be changed by the touch shutter (📖 47) or touch AF/AE (📖 52).
- Use the scene effect adjustment slider (📖 61) to adjust image brightness.



### Snow

Captures the brightness of such subjects as snowfield.

- The camera focuses on the subject at the center of the frame. The area focused can be changed by the touch shutter (📖 47) or touch AF/AE (📖 52).
- Use the scene effect adjustment slider (📖 61) to adjust image brightness.



### Sunset



Preserves the deep hues seen in sunsets and sunrises.

- The camera focuses on the subject at the center of the frame.
- The default setting for flash mode is  **Off**.
- Use the scene effect adjustment slider (📖 61) to adjust image color.



Use of a tripod is recommended in scene modes with which  is indicated. Set **Vibration reduction** (📖 158) to **Off** when using a tripod to stabilize the camera.

 Dusk/dawn

Preserves the colors seen in the weak natural light before sunrise or after sunset.

- The camera focuses at infinity. The focus area or focus indicator (📖 30) always glows green when the shutter-release button is pressed halfway. Note, however, that objects in the foreground may not always be in focus.
- Flash is disabled.
- AF-assist illuminator (📖 160) does not light.
- Use the scene effect adjustment slider (📖 61) to adjust image color.

 Night landscape

Slow shutter speeds are used to produce stunning night landscapes.







- The camera focuses at infinity. The focus area or focus indicator (📖 30) always glows green when the shutter-release button is pressed halfway. Note, however, that objects in the foreground may not always be in focus.
- Flash is disabled.
- AF-assist illuminator (📖 160) does not light.
- Use the scene effect adjustment slider (📖 61) to adjust image brightness.



## Shooting Suited to Scenes (Scene Mode)

### Close-up







Use this mode to photograph flowers, insects and other small objects at close range.

- Macro mode ( 39) is enabled and the camera automatically zooms to the closest position at which it can focus.
- The closest possible shooting distance may vary according to the zoom position. In the zoom position where the  icon and zoom indicator glow green (near the  icon), the camera can focus on subjects as close as 3 cm (1.2 in.) from the lens.
- Note that the flash may be unable to light entire subject at distances of less than 50 cm (1 ft. 8 in.).
- The camera focuses on the subject at the center of the frame. The area focused can be changed by the touch shutter ( 47) or touch AF/AE ( 52).
- The camera focuses continuously until focus is locked by pressing the shutter-release button halfway.
- As images are easily affected by camera shake, be sure that **Vibration reduction** ( 158) is enabled and hold the camera steadily.
- Use the scene effect adjustment slider ( 61) to adjust image saturation.





### Food

Use when taking pictures of food.

- Macro mode ( 39) is enabled and the camera automatically zooms to the closest position at which it can focus.
- The closest possible shooting distance may vary according to the zoom position. In the zoom position where the  icon and zoom indicator glow green (near the  icon), the camera can focus on subjects as close as 3 cm (1.2 in.) from the lens.
- Flash is disabled.
- The camera focuses on the subject at the center of the frame. The area focused can be changed by the touch shutter ( 47) or touch AF/AE ( 52).
- The camera focuses continuously until focus is locked by pressing the shutter-release button halfway.
- As images are easily affected by camera shake, be sure that **Vibration reduction** ( 158) is enabled and hold the camera steadily.
- Use the scene effect adjustment slider ( 61) to adjust the subject's hue affected by the lighting. This adjustment is saved in the camera's memory even after the camera is turned off.









Use of a tripod is recommended in scene modes with which  is indicated. Set **Vibration reduction** ( 158) to **Off** when using a tripod to stabilize the camera.



## Museum

Use indoors where flash photography is prohibited (for example, in museums and art galleries) or in other settings in which you do not want to use the flash.



- The camera focuses on subject at the center of the frame. The area focused can be changed by the touch shutter ( 47) or touch AF/AE ( 52).
- BSS (best shot selector) can be enabled ( 56).
- BSS (best shot selector) is disabled with touch shutter shooting ( 47).
- As images are easily affected by camera shake, be sure that **Vibration reduction** ( 158) is enabled and hold the camera steadily.
- Flash is disabled.
- AF-assist illuminator ( 160) does not light.



## Fireworks show



Slow shutter speeds are used to capture the expanding burst of light from a firework.



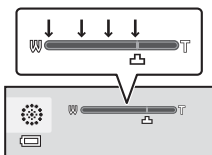

- The camera focuses at infinity. The focus indicator ( 30) always glows green when the shutter-release button is pressed halfway. Note, however, that objects in the foreground may not always be in focus.
- Flash is disabled.
- AF-assist illuminator ( 160) does not light.
- Only the four optical zoom positions shown on the right can be applied. When the zoom control is rotated, zoom will not stop at any position other than the four indicated (digital zoom is available).



## Shooting Suited to Scenes (Scene Mode)

### Black and white copy

Provides clear images of text or drawings on a white board or in print.

- The camera focuses on subject at the center of the frame. The area focused can be changed by the touch shutter ( 47) or touch AF/AE ( 52).
- Use macro mode ( 39) to focus at short ranges.
- Colored text and drawings may not show up well.
- The default setting for flash mode is  **Off**.

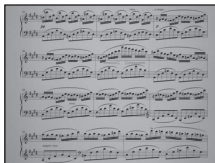



### Draw

Write a memo, or draw a picture, on the touch panel display and save it as an image. See “Using the Draw Option” ( 72) for more information.

### Backlighting

Use when light is coming from behind subject, throwing features or details into shadow. The flash fires automatically to “fill in” (illuminate) shadows.

- The camera focuses on subject at the center of the frame. The area focused can be changed by the touch shutter ( 47) or touch AF/AE ( 52).
- The flash mode setting is fixed at  **Fill flash**.
- Use the scene effect adjustment slider ( 61) to adjust image brightness.



### Panorama assist









Use when taking a series of pictures that will later be joined to form a single panorama using the supplied Panorama Maker 5 software. See “Shooting for a Panorama” ( 74) for details.

- The default setting for flash mode is  **Off**.

### Pet portrait

Use this mode for taking portraits of pets (dogs or cats). When the camera detects the face of a dog or cat, it focuses on the face and automatically releases the shutter (pet portrait auto release) three times at the default setting.



- A double border (focus area) is displayed around the detected face, and it turns green when the focus is acquired.  
Up to five faces can be detected. When the camera detects more than one face, the double border is displayed around the largest face, and single borders are displayed around the others.
- If the shutter-release button is pressed all the way down when no pet faces are detected, the camera focuses on the subject at the center of the frame.
- To change the  **Continuous** setting used in this mode, tap the bottom tab to display the setting controls.
  - **Single**: The camera captures one image at a time.
  - **Continuous** (default setting): When the pet portrait auto release function is activated and the focus is acquired on the detected face, the camera releases the shutter three times. When the pet portrait auto release function is disabled, about two images can be continuously captured at a rate of up to about 1.2 frames per second while the shutter-release button is held down (when the image mode setting is  **4608x3456**).
- To change the  **Pet portrait auto release** setting, tap the bottom tab to display the setting controls.
  - **On** (default setting): The shutter is automatically released when the focus is acquired on the detected face.
  - **Off**: The shutter is released using the shutter-release button or touch shutter ( 47).
- Digital zoom is not available.
- Flash is disabled.
- AF-assist illuminator ( 160) does not light up. Shutter sound ( 161) is disabled.
- Factors such as the distance between the pet and the camera, the orientation or brightness of the face, and the speed at which the pet is moving may prevent the camera from detecting the faces of dogs or cats or may cause it to detect faces other than those of dogs or cats.

## Using the Draw Option

Write a memo, or draw a picture, on the touch panel display and save it as an image. The image is saved at an image mode size setting of **VGA 640×480**.

- 1 Press the  button in shooting mode and tap **SCENE**.

The scene mode selection screen is displayed.

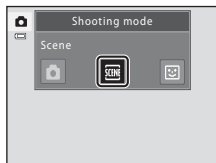
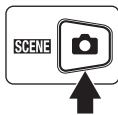



- 2 Tap  (draw) scene mode (📖 59).







- 3 Write a memo or draw pictures.

Tap  (pen) to write or draw (📖 116).

Tap  (eraser) to use the eraser (📖 116).

Tap  to display the picture in full-frame playback mode

and tap  again to enlarge the picture display by 3x.

Tap , , , or  to change the portion of the picture visible in the monitor. Tap  to return to the original display size.



- 4 Tap **OK**.

Tap , before tapping **OK**, to undo the last operation applied using the pen or eraser tool (up to the last five operations can be undone).

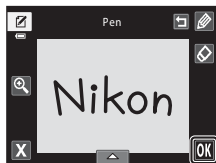

**5** Tap **Yes**.

The memo is saved.

To cancel saving the memo, tap **No**.

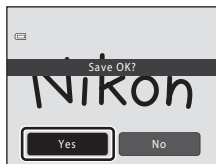

## Shooting for a Panorama

The camera focuses on the subject at the center of the frame. Use a tripod for the best results. Set **Vibration reduction** (📖 158) to **Off** in the setup menu (📖 149) when using a tripod to stabilize the camera.

- 1 Press the  button in shooting mode and tap .

The scene mode selection screen is displayed.

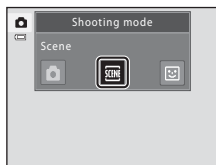
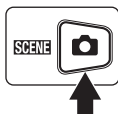

- 2 Tap  **Panorama assist** (📖 59).

Panorama direction icons are displayed to show the direction in which images will be joined.



- 3 Tap a direction icon.

Select the direction in which images will be joined in the completed panorama; right (▶), left (◀), up (▲) or down (▼).

A different direction can be selected by tapping a different panorama direction icon.

Change shooting settings (📖 60) before the first picture is taken in the next step.



- 4 Take the first picture.

One third of the image will be displayed as translucent.



## 5 Take the next picture.

Frame the next image so that one-third of the frame overlaps the previous image and press the shutter-release button.

Repeat this process until the necessary number of pictures have been taken to complete the scene.



## 6 Tap X when shooting is complete.

The camera returns to step 3.



### Notes on Panorama Assist

- Apply or adjust shooting settings (📖 60) before releasing the shutter for the first image. Shooting settings cannot be changed after the first picture is taken. Images cannot be deleted, nor can zoom operate after the first picture has been taken.
- Shooting for the panorama series is terminated if the auto off function (📖 162) initiates standby mode during shooting. Setting the time allowed to elapse before the auto off function is enabled to a longer setting is recommended.

### AE/AF-L Indicator

In **Panorama assist** scene mode, exposure, white balance, and focus for all images in a panorama are fixed at the values for the first image in each series.

When the first picture is taken, **AE/AF-L** is displayed to indicate that exposure, white balance, and focus are locked.



### Panorama Creation

Transfer images to a computer (📖 137) and use Panorama Maker 5 (📖 141) to join them in a single panorama. Install Panorama Maker 5 from the supplied ViewNX 2 CD.

### More Information

See "File and Folder Names" (📖 178) for more information.

## Shooting Smiling Faces (Smart Portrait Mode)

At the default settings, the camera uses the face detection function to detect human faces, and then automatically releases the shutter when a smile is detected (smile timer). The skin softening option can be used to smooth skin tones of human faces.

### 1 Press the button in shooting mode and tap .

The camera enters smart portrait mode.

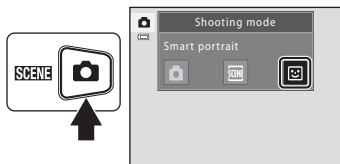

### 2 Frame a picture.

Point the camera at the subject.

When the camera detects a human face, a yellow double border (focus area) is displayed around that face. When focus is acquired on that face, the double border will turn green for a moment and focus is locked.

Up to three faces can be detected. When the camera detects more than one face, the double border is displayed around the face closest to the center of the frame, and single borders around the others.

Tap the face framed by a single border to change the focus area to that face.



### 3 The shutter is automatically released.

If the camera detects that the face framed by the double border is smiling, **Smile timer** (📖 79) is activated and the shutter is automatically released.

Each time the shutter is released, the camera again initiates face detection and smile detection operations for continuous automatic shooting.

### 4 Shooting ends.

To stop automatic shooting of smiling faces, either turn the camera off, set **Smile timer** to **Off**, or press the  button and select another shooting mode.

### Notes on Smart Portrait Mode

- Digital zoom is not available.
- In some shooting conditions, the camera may be unable to detect faces or smiles.
- See “Notes on the Face Detection Function” (📖 42) for more information.



## Notes on Skin Softening Function

- More time than usual may be required to save an image when shooting with skin softening function.
- In some shooting conditions, facial skin tones may not be smoothed or parts other than face may be modified though the camera detects a face. If the desired results are not produced, set **Skin softening** to **Off** and shoot again.
- The skin softening level cannot be adjusted when the portrait or night portrait scene mode is selected.
- Retouch effects such as the glamour retouch function's skin softening effect can be applied to images after they are captured ( 124).

## Self-timer Lamp

The self-timer lamp blinks slowly when the smile timer is enabled and the camera detects a face, and it blinks quickly immediately after the shutter is released.

## Releasing the Shutter Manually

Pictures can also be taken by pressing the shutter-release button. The camera focuses on the subject at the center of the frame when faces are not detected.

## Auto Power Off in Smile Timer Mode

When **Smile timer** is set to **On**, the auto off function ( 162) is activated and the camera turns off when either of the situations indicated below persists and no other operations are performed.

- The camera does not detect any faces.
- The camera detected a face, but cannot detect a smile.

## More Information

See "Autofocus" ( 31) for more information.

## Changing the Smart Portrait Mode Settings

The settings indicated below can be made by tapping the tabs to display the setting controls in smart portrait mode.

- Each icon also indicates the current setting.
- Tap the icon of the desired item to display the setting screen for that item.
- Tap the tab again to hide the setting controls.

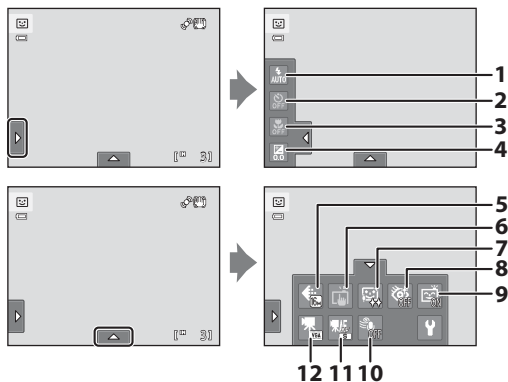

**1** **Flash mode**

Set the flash mode (📖 34) when taking pictures in smart portrait mode.

**2** **Self-timer**

Set the self-timer mode (📖 37). This setting is not available when **Smile timer** (📖 79) is set to **On**.

**3** **Macro mode**

Macro mode (📖 39) is not available.

**4** **Exposure compensation**

Adjust **Exposure compensation** setting (📖 40) used when shooting in smart portrait mode.

**5** **Image mode**

Choose the image mode (combination of image size and compression rate) at which images are saved (📖 45). Changes made to the image mode setting apply to all shooting modes.

6  Touch shooting

Can be changed between touch shutter ( 47) and touch AF/AE ( 52). This setting is not available when **Smile timer** is set to **On**.

7  Skin softening

Enable skin softening. When the shutter is released, the camera detects one or more human faces (up to three), and processes the image to soften facial skin tones before saving the image.

The degree of skin softening applied can be selected from **High**, **Normal** (default setting), and **Low**. When **Off** is selected, the skin softening function is disabled.

- The effects of skin softening are not visible when framing pictures for shooting. Check the degree of skin softening performed in playback mode.

8  Blink proof

When **On** is selected, the camera automatically releases the shutter twice each time a picture is taken. Of the two shots, one in which the subject's eyes are open is saved.

- If the camera saved an image in which the subject's eyes may have been closed, the dialog shown on the right is displayed for a few seconds.
- When **On** is selected, the flash is disabled.
- The default setting is **Off**.

9  Smile timer

- **On** (default setting): The camera uses the face detection function to detect a human face, and then automatically releases the shutter whenever a smile is detected.
- **Off**: The camera does not release the shutter automatically with smile detection. Press the shutter-release button to take a picture.

10  Wind noise reduction

Set whether or not to reduce wind noise during movie recording ( 132).

11  Movie AF mode

Select how the camera focuses during movie recording ( 128, 131).

12  Movie options

Select the desired movie option when recording movies ( 128, 130).

## Settings in Smart Portrait Mode

There are functions with which this setting cannot be enabled. See "Camera Settings That Cannot Be Applied Simultaneously" ( 80) for more information.





## Camera Settings That Cannot Be Applied Simultaneously

Some shooting settings cannot be used with other functions.

Restricted function	Option	Description
Flash mode	Continuous (📖 56)	When <b>Continuous</b> , <b>BSS</b> , or <b>Multi-shot 16</b> is selected, flash is disabled.
	Blink proof (📖 79)	When <b>On</b> is selected, flash is disabled.
Self-timer	Subject tracking (📖 50)	When the touch shooting is set to <b>Subject tracking</b> , self-timer is disabled.
Macro mode	Subject tracking (📖 50)	When the touch shooting is set to <b>Subject tracking</b> , macro mode is disabled.
Image mode	Continuous (📖 56)	When <b>Multi-shot 16</b> is selected, the <b>Image mode</b> setting is fixed at <b>5M</b> (image size: 2560 × 1920 pixels).
ISO sensitivity	Continuous (📖 56)	When <b>Multi-shot 16</b> is selected, the <b>ISO sensitivity</b> setting is automatically specified according to the brightness.
Continuous	Self-timer (📖 37)	When taking a picture using the self-timer, the continuous setting is fixed at <b>Single</b> .
	Touch shutter (📖 47)	When using the touch shutter function, one image is captured each time the monitor is tapped.
Motion detection	Subject tracking (📖 50)	When taking a picture using the subject tracking function, <b>Motion detection</b> is disabled.
	ISO sensitivity (📖 55)	When the ISO sensitivity is set to any setting other than <b>Auto</b> , <b>Motion detection</b> is disabled.
	Continuous (📖 56)	When <b>Multi-shot 16</b> is selected, <b>Motion detection</b> is disabled.
Digital zoom	Subject tracking (📖 50)	When the touch shooting is set to <b>Subject tracking</b> , digital zoom is disabled.
	Continuous (📖 56)	When <b>Multi-shot 16</b> is selected, digital zoom is not available.
Blink warning	Continuous (📖 56)	When <b>Continuous</b> , <b>BSS</b> , or <b>Multi-shot 16</b> is selected, <b>Blink warning</b> is disabled.

### **Restricted Functions in Shooting Mode**



The restricted functions vary with the shooting mode ( 41). See the following pages for details on the functions available in each shooting mode:

-  (auto) mode →  44
- Scene mode →  60
- Smart portrait mode →  78

### **More Information**















See “Notes on Digital Zoom” ( 160) for more information.

## Operations in Full-frame Playback Mode

Press the  (playback) button to enter playback mode and display images that have been captured ( 32).



The following operations are available in full-frame playback mode.

Function	Icon/button	Description	
Select an image	–	Drag the image to the right to display the previous image and to the left to display the next image.	32
View thumbnails	<b>W</b> 	Rotate the zoom control to <b>W</b>  to display 4, 9 or 16 image thumbnails.	83
Playback zoom	<b>T</b> 	Rotate the zoom control to <b>T</b>  to enlarge the image up to 10x. Tap <b>X</b> to return to full-frame playback mode.	85
Playback movies		Tap  to play back the movie currently displayed.	133
Set the image rating/play back images by rating	Right tab 	Apply a rating of one to five to each image or play back images by rating.	101
Make playback settings	Bottom tab	Tap the bottom tab to specify the playback settings and edit images.	100
Switch to another playback mode		Press the  button to display the playback-mode selection menu and change to favorite pictures, auto sort, or list by date mode.	87
Switch to shooting mode	  	Press the  button,  (movie-record) button, or shutter-release button.	32

### Changing the Orientation (Vertical/Horizontal) of Images





Image orientation can be changed after taking a picture using Rotate image ( 110).

## Viewing Multiple Images: Thumbnail Playback

Rotate the zoom control to **W** (📐) in full-frame playback mode (📖 82) to display images in “contact sheets” of thumbnail images.



The following operations are available while thumbnails are displayed.

Function	Icon/button	Description	📖
Increase the number of images displayed	<b>W</b> (📐)	Rotate the zoom control to <b>W</b> (📐) to increase the number of the image thumbnails displayed: 4 → 9 → 16.	
Decrease the number of images displayed	<b>T</b> (📐)	Rotate the zoom control to <b>T</b> (📐) to decrease the number of image thumbnails displayed: 16 → 9 → 4. Rotate the zoom control to <b>T</b> (📐) in 4-image thumbnail display to return to full-frame playback mode.	–
Scroll display	⬆️ or ⬇️	Tap ⬆️ or ⬇️. It is also possible to scroll through the thumbnails by dragging your finger up or down across the monitor.	–
Switch to full-frame playback mode	–	Tap an image.	32
Set the image rating/play back images by rating	Right tab (★)	Apply a rating of one to five to each image or play back images by rating.	101
Make playback settings	Bottom tab	Tap the bottom tab, and <b>Delete</b> , <b>Slide show</b> , <b>Protect</b> , or <b>Print order</b> settings can be enabled.	100
Switch to shooting mode	  	Press the  button,  (🎬 movie-record) button, or shutter-release button.	32

## Viewing Multiple Images: Thumbnail Playback

### **Thumbnail Playback Mode Display**

When images with rating (📖 101), or marked using **Protect** (📖 104) are selected, the icons shown on the right are displayed with them. Movies are displayed as film frames.

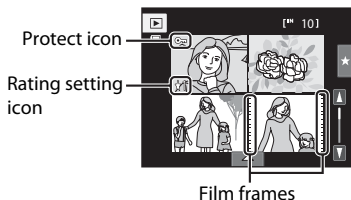

### **Thumbnail Display in Favorite Pictures and Auto Sort Mode**

- In favorite pictures mode (📖 88), the favorite pictures icon is displayed in the monitor.
- In auto sort mode (📖 95), the images' category icon is displayed in the monitor.









## Taking a Closer Look: Playback Zoom

Rotating the zoom control to **T** (📏) in full-frame playback mode (📖 82) enlarges display of the center portion of the current image.

- The guide displayed at bottom right shows the portion of the image currently displayed.



The following operations can be performed while image display is enlarged.

Function	Icon/button	Description	📖
Zoom in	<b>T</b> (📏)	Zoom increases each time the zoom control is rotated to <b>T</b> (📏), to a maximum of 10x.	-
Zoom out	<b>W</b> (📏)	Zoom decreases each time the zoom control is rotated to <b>W</b> (📏). When the magnification ratio reaches 1x, the display returns to full-frame playback mode.	-
Change the display area	-	The area of the image currently displayed can be changed by dragging the image.	-
Delete images	🗑️	Tap 🗑️ to delete the image.	33
Switch to full-frame playback	✕	Tap ✕ to switch to full-frame playback.	32
Crop image	✂️	Tap ✂️ to crop current image to contain only the portion visible in the monitor.	127
Switch to shooting mode	  	Press the  button,  (▶️📽️ movie-record) button, or shutter-release button.	32

## Images Captured with Face Detection or Pet Detection









When zooming in (playback zoom) on an image captured using the face detection (📖 42) or pet detection (📖 71) function by rotating the zoom control to **T** (📷), the image will be enlarged with the face detected at the time of shooting at the center of the monitor (except images captured with **Subject tracking** (📖 50), **Continuous, BSS**, and **Multi-shot 16**; 📖 56, 71).



- If more than one face was detected, the image will be enlarged with the face on which focus was acquired at the center of the monitor. Tap 📷 or 📷 to display other detected faces.
- When the zoom control is further rotated in the **T** (📷) or **W** (📷) direction, the zoom ratio changes and becomes a normal playback zoom display.

# Selecting Playback Mode

Following playback modes can be selected.

- |  |                               |  |
|--|-------------------------------|--|
|                         | <b>Playback mode</b>          |  32 |
| Play back all images.  |                               |  |
|                         | <b>Favorite pictures mode</b> |  88 |
| Play back images added to an album.  |                               |  |
|                         | <b>Auto sort mode</b>         |  95 |
| Play back images and movies by selecting the category to which they were sorted at the time of shooting. |                               |  |
|                         | <b>List by date mode</b>      |  98 |
| Play back images captured on the selected date.  |                               |  |

## 1 Press the button in playback mode.

The playback mode selection menu is displayed.

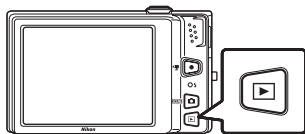

## 2 Tap the desired playback mode icon.

The camera enters the selected playback mode.

To return to the current playback mode, press the  button.

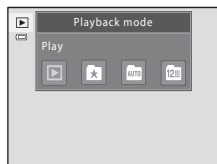

## Sorting Favorite Pictures (Favorite Pictures Mode)

Images can be sorted to albums. Once images have been sorted to albums, “★ favorite picture mode” can be used to play back only the images in a specific album.

- Adding images to albums makes finding a particular image faster and easier.
- Images can be sorted to albums categorized by themes such as travel or weddings.
- A single image can be added to multiple albums.

### Adding Images to Albums

Images can be added to albums and sorted.

**1** Display images in playback mode (📖 32), auto sort mode (📖 95), or list by date mode (📖 98).

**2** Select an image and tap the bottom tab.

Display an image in full-frame playback mode and tap the bottom tab.

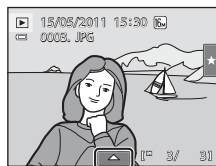

**3** Tap ★.

The albums selection screen is displayed.



**4** Tap the desired album.

The image is added to the album and monitor display returns to full-frame playback mode.

Repeat from step 1 or step 2 to add an image to multiple albums.



### **Notes on Adding Favorite Pictures**

- An album can contain up to 200 images.
- Movies cannot be added to albums.
- If the selected image has already been added to an album, the album icon turns yellow.
- When images are added to albums, they are not physically copied to albums or moved from the folder (📁 178) to which they were originally saved (📁 94).

### **More Information**

See “Removing Images from Albums” (📖 91) for more information.

## Viewing Images in an Album

Images can be displayed by selecting the album to which they were added in “Favorite pictures mode.”

- In full-frame playback mode, just as with normal playback mode, images can be displayed as thumbnails, or image display can be enlarged. When the bottom tab is tapped to display the setting controls, settings can be made and editing can be performed on images sorted to the specified album (📖 100).

- 1** Press the  button in playback mode and tap .

A list of albums is displayed.

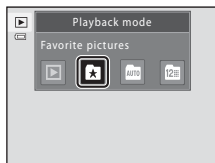

- 2** Tap the desired album.

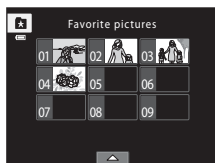

The images in the selected album will be displayed in full-frame playback mode.

The icon for the current album is displayed on the screen.

Repeat steps 1 and 2 to select a different album.

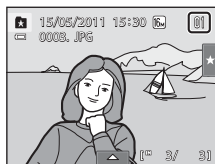

## Removing Images from Albums

To remove an image from an album without permanently deleting it, follow the procedures described below.

- Select the desired image in full-frame display in step 2 in favorite pictures mode (📖 90), tap the bottom tab to display the setting controls, and then tap . The confirmation dialog is displayed.
- Tap **Yes** to remove the image from the album. To exit without removing the image, tap **No**.















### Note on Deleting Images in Favorite Pictures Mode

Note that deleting an image in favorite pictures mode deletes not only the image from the album, but also deletes the original image from the internal memory or memory card permanently (📖 94).

## Operations in Favorite Pictures Mode

The following operations are available in the album list screen (step 2 of  90).

Function	Icon/button	Description	
Change the album icon		Tap the bottom tab to display the setting controls, and tap  .	93
Delete all images in the selected album		When the bottom tab is tapped to display the setting controls, and  is tapped, the album selection screen is displayed. Select the desired album and tap <b>OK</b> .	-
Switch to another playback mode		Press the  button to display the playback-mode selection menu.	87
Switch to shooting mode	  	Press the  button,  (movie-record) button, or shutter-release button.	32





## Changing Icons Assigned to Albums

The icon assigned to an album can be changed to reflect the theme of images included in the album.

- 1 Press the  button in playback mode and tap .

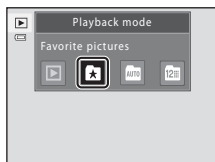
A list of albums is displayed.



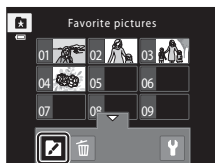

- 2 Tap the bottom tab to display the setting controls and tap .

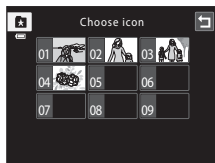

- 3 Tap the desired folder.

The album icon and icon color selection screen is displayed.



- 4 Tap the desired icon to be assigned to an album, tap or drag the slider to select the icon's color, and tap .

The icon is modified and the monitor display returns to the list of albums.

Tap  to return to the album selection screen without changing settings.

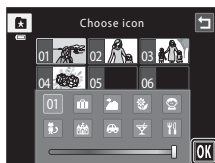

### Notes on Icons for Albums

Choose icons for albums separately for the internal memory and for every memory card used.

- To change the icon for an album containing images saved in the internal memory, remove the memory card from the camera.
- The default setting for icons are numbers.

## Sorting Favorite Pictures (Favorite Pictures Mode)

### Adding/Viewing Favorite Pictures

When images are added to albums, they are not physically copied to albums or moved from the folder to which they were originally saved (📖 178). Only the file names of images are added to albums. In favorite pictures mode, images with file names that have been added to the specified album are played back. Note that deleting an image (📖 33, 92) played back in favorite pictures mode deletes not only the image from the album, but also deletes the original image from the internal memory or memory card permanently.

### Adding Images to Albums

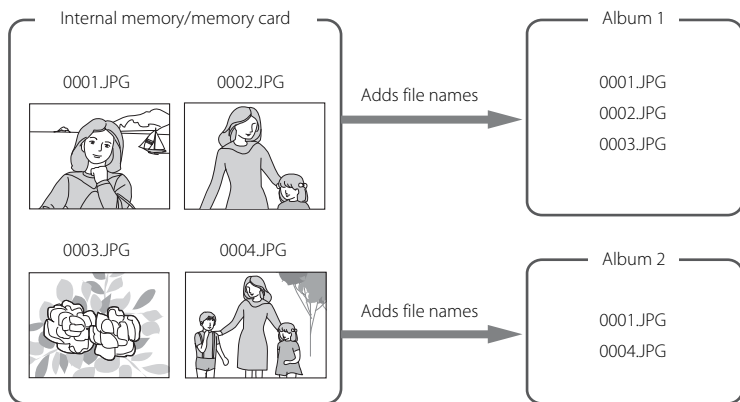





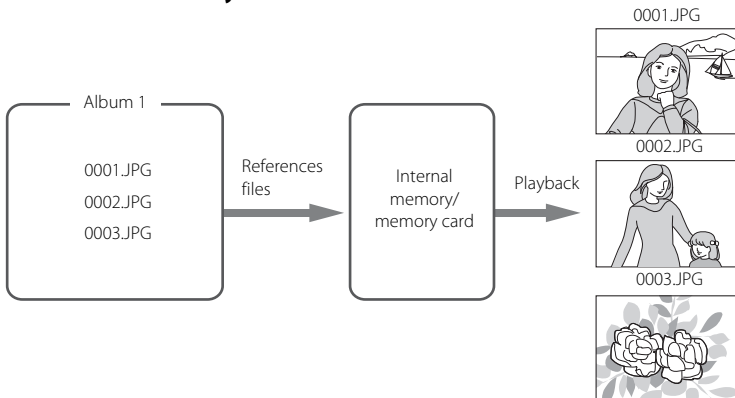





More on Playback

### Favorites Picture Playback



## Image Searching in Auto Sort Mode

When taking pictures and movies, they are automatically sorted to one of the categories shown below. When “**AUTO** (auto sort) mode” is selected, images and movies can be viewed by selecting the category to which they were sorted.

 Smile	 Portrait	 Food
 Landscape	 Dusk to dawn	 Close-up
 Pet portrait	 Movie	 Retouched copies
 Other scenes		

- In full-frame playback mode, just as with normal playback mode, images can be displayed as thumbnails, or image display can be enlarged, and movies can be played back. When the bottom tab is tapped to display the setting controls, settings can be made and editing can be performed on images sorted to the specified category ( 100).

## Viewing Images in Auto Sort Mode

- 1** Press the  button in playback mode and tap **AUTO**.

A list of categories is displayed.

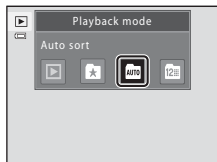

- 2** Tap the desired category.

For more information on categories, see “Auto Sort Mode Categories” ( 96).















An image sorted to the selected category will be displayed in full-frame playback mode.

The icon for the category currently selected is displayed.

Repeat steps 1 and 2 to select a different category.



## Auto Sort Mode Categories

Category	Description
 Smile	Images captured in smart portrait mode (📖 76) with the smile timer setting set to <b>On</b> are displayed.
 Portrait	Images captured in  (auto) mode (📖 26) with the face detection function. Images captured in <b>Portrait*</b> , <b>Night portrait*</b> , <b>Party/indoor</b> , and <b>Backlighting*</b> scene modes (📖 59). Images captured in smart portrait mode (📖 76) with the smile timer setting set to <b>Off</b> .
 Food	Images captured in <b>Food</b> scene mode (📖 59).
 Landscape	Images captured in <b>Landscape*</b> scene mode (📖 59).
 Dusk to dawn	Images captured in <b>Sunset</b> , <b>Dusk/dawn</b> , <b>Night landscape*</b> , and <b>Fireworks show</b> scene modes (📖 59).
 Close-up	Images captured in  (auto) mode with the macro mode setting (📖 39). Images captured in <b>Close-up*</b> scene mode (📖 59).
 Pet portrait	Images captured in <b>Pet portrait</b> scene mode (📖 59).
 Movie	Movies (📖 128).
 Retouched copies	Copies created using editing functions (📖 113).
 Other scenes	All other images that cannot be defined by the categories described above are displayed.











\* Images captured in scene auto selector (📖 62) are also sorted to the appropriate categories.

### Notes on Auto Sort Mode

- Up to 999 images and movie files can be sorted to each category in auto sort mode. If 999 images or movies have already been sorted to a specific category, new images and movies cannot be sorted to that category or displayed in auto sort mode. Display images and movies that could not be sorted to a category in normal playback mode (📖 32) or list by date mode (📖 98).
- Images or movies copied from the internal memory to a memory card, or vice versa (📖 171), cannot be displayed in auto sort mode.
- Images or movies saved by a camera other than the COOLPIX S6100 cannot be displayed in auto sort mode.

## Operations in Auto Sort Mode

The following operations are available in the category list screen (step 2 of  95).

Function	Icon/button	Description	
Delete all images in the selected category		When the bottom tab is tapped to display the setting controls, and  is tapped, the category selection screen is displayed. Select the desired category and tap <b>OK</b> .	-
Switch to another playback mode		Press the  button to display the playback-mode selection menu.	87
Switch to shooting mode	  	Press the  button,  (  movie-record) button, or shutter-release button.	32

## Selecting Images Captured on a Specific Day (List by Date Mode)

In “ list by date mode”, images captured on a same date can be played back.

- In full-frame playback mode, just as with normal playback mode, images can be displayed as thumbnails, or image display can be enlarged, and movies can be played back. When the bottom tab is tapped to display the setting controls, settings can be made and editing can be performed on images captured on a specific day ( 100).

### Selecting a Date in List by Date Mode

- 1 Press the  button in playback mode and tap .

Dates for which images exist are listed.

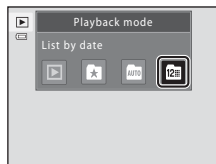

- 2 Tap the desired date.

To change the displayed month, tap  or .

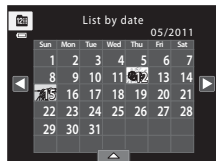

The first image captured on the selected date will be displayed in full-frame playback mode.

Repeat steps 1 and 2 to select a different date.

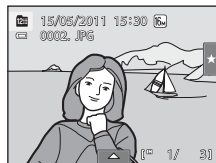















### Notes on List by Date Mode

- Up to 9,000 of the most recently saved images can be displayed in list by date mode.
- Images captured when the camera's date and time have not been set are treated as images captured on January 1, 2011.

## Operations in List by Date Mode

The following operations are available in the list by date screen (step 2 of  98).

Function	Icon/button	Description	
Change the month	 or 	Tap  or  .	–
Delete all images in the selected date		When the bottom tab is tapped to display the setting controls, and  is tapped, the date selection screen is displayed. Select the desired date and tap <b>OK</b> .	–
Switch to another playback mode		Press the  button to display the playback-mode selection menu.	87
Switch to shooting mode	  	Press the  button,  (movie-record) button, or shutter-release button.	32

## Playback Options

To adjust image settings or edit images, tap the tab in full-frame playback mode to display the setting controls.

- The controls available and monitor display vary depending upon the current image and camera settings.
- Tap the icon of the desired item to display the setting screen for that item.
- Tap the tab again to hide the setting controls.

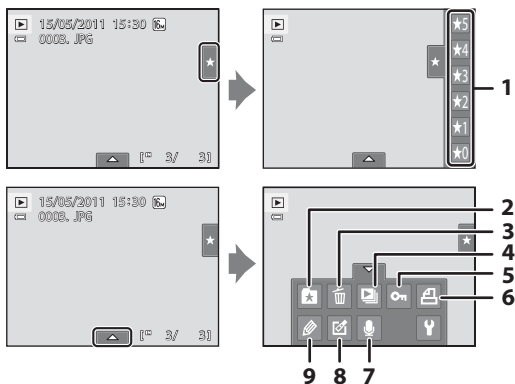

<b>1</b>	Rating* .....	101
<b>2</b>	★ Add images to albums (except in favorite pictures mode) .....	88
	Remove images from albums (in favorite pictures mode) .....	91
<b>3</b>	🗑 Delete* .....	33
<b>4</b>	📺 Slide show* .....	102

<b>5</b>	🔒 Protect* .....	104
<b>6</b>	🖨 DPOF print order* .....	106
<b>7</b>	🎤 Voice memo .....	111
<b>8</b>	🔍 Retouch .....	113
	🔄 Rotate image .....	110
<b>9</b>	🖌 Paint .....	115

\* This function can also be performed in thumbnail playback mode. If the camera is switched to thumbnail playback mode while images are played back in favorite pictures, auto sort, or list by date mode, this function can be performed only on the images sorted to the selected folder, category or date.



## Setting the Image Rating

A rating of one to five can be assigned to each image. It is also possible to play back only the images that have been assigned a specific rating.

- 1 Tap the right tab in full-frame playback (📖 82) or thumbnail playback (📖 83) mode.  
See "Operating the Tabs" (📖 14) for more information.

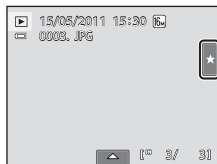

- 2 Drag and drop (📖 8) the desired rating icon onto the image.  
Rating is applied.  
Drag and drop another icon to change the rating.  
Drag and drop ★0 to cancel the rating.  
An image's rating can be confirmed by the number of ☆ shown in full-frame playback mode.

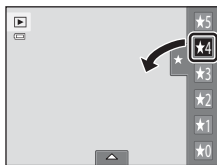

## Playing Back Images by Rating

- 1 Tap the right tab in full-frame playback (📖 82) or thumbnail playback (📖 83) mode.



- 2 Tap a rating icon to display the images with that rating.  
The icon of the tapped rating turns yellow, and only the images assigned with the selected rating are displayed.  
Multiple ratings can be selected.  
To stop displaying images of a selected rating, tap the icon of the rating to deselect it.  
To stop playback by rating, deselect all ratings.



### ✓ Notes on the Rating

- Each rating can be applied to a maximum of 999 images.
- Rating cannot be applied to movies.
- The ratings applied on the COOLPIX S6100 are not recognized by your computer.





## Enjoying Slide Show

Play back images saved in the internal memory or on a memory card one by one in an automated “slide show.”

- 1 Tap the bottom tab in playback mode to display the setting controls, and tap .



- 2 Tap .

Tap  (effects),  (frame interval),  (background music), or  (volume) to change each setting (103) before tapping .

To repeat slide show automatically, tap  (loop playback).

To exit without playing back images in a slide show, tap .

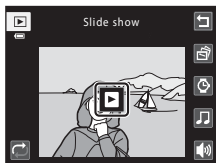









- 3 The slide show begins.

Tap the monitor to display the operation panel at the bottom of the screen.

Tap the icons in the operation panel to perform the corresponding operation. The following operations are available.



Function	Icon	Description
Volume		Adjust the volume of background music. Volume can also be adjusted by rotating the zoom control to <b>T</b> or <b>W</b> .
Rewind		Tap and hold  to rewind slide show.
Advance		Tap and hold  to advance slide show.
Pause		Pause playback. <ul style="list-style-type: none"><li>• To resume playback, tap  displayed at the center of the screen.</li></ul>
End		End slide show.

### Notes on Slide Show

- Only the first frame of movies included in slide shows is displayed.
- Even when  is selected, the slide show will only be played for a maximum of 30 minutes (162).

## Slide Show Options

Tap  (effects),  (frame intvl),  (background music) or  (volume) in the step 2 under “ Enjoying Slide Show” ( 102) to change each setting.

### Effects

Select from **Classic** (default setting), **Zoom** or **Animated**.

### Frame intvl

Select the length of time each image is displayed from **2 s**, **3 s** (default setting), **5 s**, and **10 s**.



### Background music

Select from **Up-tempo**, **Moderate tempo**, **Slow tempo**, and **None** (default setting).

### Volume

Tap the volume icon to adjust the volume of the background music.

## Protecting Important Images (Protect)

Protect selected images from accidental deletion. Protected images can be identified by the  icon ( 12) in playback mode.

### Protecting One Image

- 1 Select the desired image to be protected in full-frame playback mode and tap the bottom tab.



- 2 Tap .



- 3 Tap **On**.

The selected image is protected.

To exit without protecting images, tap .

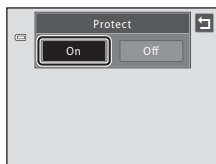

### Note on Protecting Images

Note that formatting the camera's internal memory or the memory card will permanently delete protected files ( 163).

## Protecting Multiple Images

Multiple images can be protected at a time.

- 1 Switch to thumbnail playback mode (📖 83), tap the bottom tab to display the setting controls, and tap **On**.

The monitor display switches to the **Protect** screen.

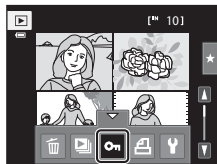

- 2 Tap the desired images to be protected.

When an image is selected, a check mark is displayed. To cancel the selection, tap the image again.

Tap **🔍** or **🔍**, or rotate the zoom control to **T** (🔍) or **W** (🔍) to change the number of images displayed.



- 3 Tap **OK**.

The selected images are protected.

To exit without protecting images, tap **🔍**.





## Removing Protection from Images

- To remove protection from an image, display a protected image in full-frame playback mode, follow the procedure in “Protecting One Image” (📖 104), and tap **Off** in step 3.
- To remove protection from multiple images at a time, uncheck protected images in step 2 of “Protecting Multiple Images.”

## Creating a DPOF Print Order

When printing images saved on the memory card using any of the following methods, the **Print order** option in the playback menu is used to create digital “print orders” for printing on DPOF-compatible devices.

- Inserting the memory card into a DPOF-compatible ( 196) printer’s card slot
- Taking the memory card to a digital photo lab
- Connecting the camera to a PictBridge-compatible ( 196) printer ( 143). A print order can also be created for images saved in the internal memory if the memory card is removed from the camera

### Creating a Print Order for One Image

- 1** Select the desired image in full-frame playback mode and tap the bottom tab.



- 2** Tap .



- 3** Tap the desired number of copies (up to nine) and tap .

To exit without making the print order, tap .



If the total number of images in a print order, including images just added, exceeds 99, the screen shown on the right will be displayed.

- Tap **Yes** to remove images previously added from the print order and restrict the print order to images just marked.
- Tap **Cancel** to remove the images just added from the print order and restrict the print order to images previously marked.

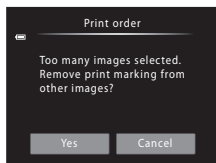



#### 4 Choose whether or not to print shooting date and shooting information.

Tap **Date** to place  in the checkbox to imprint the shooting date on the image.

Tap **Info** to place  in the checkbox to imprint the shooting information (shutter speed and aperture) on the image.

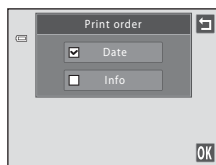
Tap **OK** to complete the print order.



Images selected for printing can be identified by the  icon displayed with playback.



More on Playback

## Creating a Print Order for Multiple Images

- 1 Switch to thumbnail playback mode (📖 83), tap the bottom tab to display the setting controls, and tap 🖨️.

The monitor switches to the print selection screen.



- 2 Tap the desired images to print (up to 99) and tap 📄 or 📄 at the upper left in the monitor to specify the number of copies (up to nine) for each.

Images selected for printing can be identified by the check mark (✔️) and the numeral indicating the number of copies to be printed. If no copies have been specified for images, the selection is canceled.

Tap 📄 or 📄, or rotate the zoom control to **T** (🔍) or **W** (📐) to change the number of images displayed.

Tap 🗑️ to remove print marking from all images and cancel the print order.

Tap **OK** when setting is complete.



- 3 Choose whether or not to print shooting date and shooting information.

Tap **Date** to place ✔️ in the checkbox to imprint the shooting date on all images in the print order.

Tap **Info** to place ✔️ in the checkbox to imprint the shooting information (shutter speed and aperture) on all images in the print order.

Tap **OK** to complete the print order.

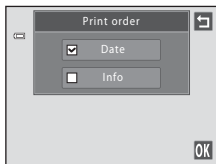



## Canceling Print Order

- To remove a print marking from an image, display an image selected for printing in full-frame playback mode, follow the procedure in “Creating a Print Order for One Image” (106), and tap “0” in step 3.
- To remove print markings from multiple images at a time, remove the print markings of the desired images in step 2 of “Creating a Print Order for Multiple Images” (108). Tap  to remove print markings from all images.

### Notes on Printing Shooting Date and Shooting Information

When the **Date** and **Info** options are enabled in the print order option, shooting date and shooting information are printed on images when a DPOF-compatible printer (196) that supports printing of shooting date and shooting information is used.

- Shooting information cannot be printed when the camera is connected directly to a printer, via the supplied USB cable, for DPOF printing (148).
- Note that **Date** and **Info** settings are reset each time the **Print order** is displayed again.
- The date printed is that saved when the image was captured. Changing the camera’s date using the **Date and time** or **Time zone** setting in the **Time zone and date** option in the setup menu after an image has been captured has no effect on the date printed on the image.





### Print Date

When shooting date and time are imprinted on images using the **Print date** option (157) in the setup menu, images are saved with shooting date and time imprinted on the image when they are captured. Images with the date imprinted on them can be printed from printers that do not support printing of the date on images.

Only the date and time imprinted on images with the print date option will be printed, even if the **Print order** date option is enabled.

## Rotate Image

Specify the orientation in which saved images are displayed with playback. Still images can be rotated 90 degrees clockwise or 90 degrees counterclockwise. Images that were saved in portrait (“tall”) orientation can be rotated up to 180 degrees in either direction.

- 1 Select an image in the full-frame playback mode ( 82), tap the bottom tab to display the setting controls, and tap .

The retouch menu is displayed.



- 2 Tap .

The rotate image screen is displayed.

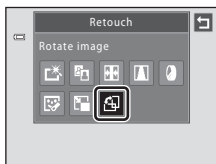

- 3 Tap  or .

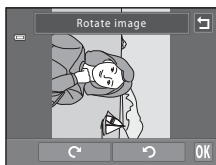

Rotate 90 degrees clockwise

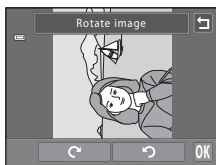
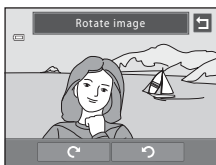

Rotate 90 degrees counterclockwise

The image rotates 90 degrees.

Tap **OK** to finalize display orientation and save the orientation information with the image.

To exit without rotating image, tap .

## Voice Memo: Recording and Playback

Use the camera's built-in microphone to record voice memos for images.

### Recording Voice Memos

- 1 Select the desired image from full-frame playback mode ( 82) and tap the bottom tab.



- 2 Tap .

The screen for recording voice memos is displayed.



- 3 Tap  to record a voice memo.

Recording ends after about 20 seconds.

Do not touch the built-in microphone during recording.

To exit without recording voice memos, tap .

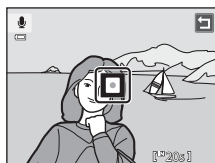

During recording, **REC** blinks in the monitor.

Recording ends when  is tapped during recording.

When recording ends, the voice memo playback screen is displayed. Follow the instructions in step 3 of "Playing Voice Memos" ( 112) to play the voice memo.

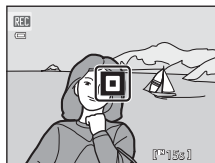

### More Information

See "File and Folder Names" ( 178) for more information.

## Playing Voice Memos

Images for which voice memos have been recorded are indicated by  in full-frame playback mode.

- 1 Select the desired image from full-frame playback mode ( 82) and tap the bottom tab.



- 2 Tap .

The voice memo playback screen is displayed.



- 3 Tap  to play the voice memo.

Tap  to stop playback.

Tap  during playback to adjust playback volume.

 blinks during playback.

To exit without playing voice memos, tap .



## Deleting Voice Memos

Tap  in step 3 of “Playing Voice Memos.” Tap **Yes** to delete only the voice memo.

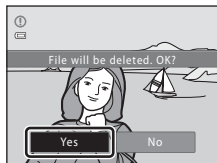

### Notes on Voice Memos

- When an image with a voice memo attached is deleted, both the image and its voice memo are deleted.
- If a voice memo already exists for the current image, it must be deleted before a new voice memo can be recorded.
- The COOLPIX S6100 is not able to record a voice memo for images captured with another make or model of digital camera.

## Editing Functions

Use the COOLPIX S6100 to edit images in-camera and save them as separate files (📖 178). The editing functions described below are available.

Editing function	Description
Paint (📖 115)	Draw on images, or add decorations, to images.
Quick retouch (📖 118)	Easily create retouched copies in which contrast and saturation have been enhanced.
D-Lighting (📖 119)	Create a copy of the current image with enhanced brightness and contrast, brightening dark portions of the image.
Stretch (📖 120)	Stretch the current image horizontally to make the subject appear thinner or wider.
Perspective control (📖 121)	Adjust the perspective of images captured in landscape orientation. Apply perspective control similar to that available with shift lenses. This option is suited to images of buildings or architecture.
Filter effects (📖 122)	Apply a variety of effects using digital filter. The available effects are <b>Color options</b> , <b>Soft</b> , <b>Selective color</b> , <b>Cross screen</b> , <b>Fisheye</b> , and <b>Miniature effect</b> .
Glamour retouch (📖 124)	Make faces appear smoother, make faces smaller, and make eyes larger.
Small picture (📖 126)	Create a small copy of images suitable for use as e-mail attachments.
Crop (📖 127)	Crop a portion of the image. Use to zoom in on a subject or arrange a composition.

See page 110 for the rotate image function for more information.

### ✔ Notes on Image Editing

- Images captured at an **Image mode** setting (📖 45) of **4608x2592** cannot be edited.
- The editing functions of COOLPIX S6100 cannot be used for images captured with another make or model of digital cameras.
- If no face is detected in an image, a copy cannot be created using the glamour retouch function (📖 124).
- Edited copies created with COOLPIX S6100 may not be displayed properly on a different model of digital camera. It may also be impossible to transfer them to a computer using a different model of digital camera.
- Editing functions are not available when there is not enough free space in the internal memory or on the memory card to save the edited copies.
- Images created in draw scene mode (📖 72) can only be edited with the paint, small picture, or crop function.



### Restrictions on Image Editing

When an edited copy is further modified with another editing function, check the following restrictions.

Editing function used	Editing function to add
Paint	The paint, small picture, or crop function can be added.
Quick retouch D-Lighting Stretch Perspective control Filter effects	The paint, glamour retouch, small picture, or crop function can be added.
Glamour retouch	The editing functions other than glamour retouch can be added.
Small picture	Another editing function cannot be added.
Crop	Another editing function cannot be added. However, the paint function can be applied to cropped copies saved at an image size of 640 × 480 pixels or larger.

- Copies created with editing functions other than the paint function cannot be further edited with the same function used to create them.
- When combining the small picture or crop function and another editing function, use the small picture and crop functions after other editing functions have been applied.
- Retouch effects such as the glamour retouch function's skin softening effect can be applied to images captured with the skin softening function ( 79).

### Original and Edited Images

- Copies created with editing functions are not deleted if the original images are deleted. The original images are not deleted if copies created with editing functions are deleted.
- Edited copies are saved with the same shooting date and time as the original.
- The rating settings ( 101), protect settings ( 104), and print markings ( 106) of the original image are not applied to edited copies.



# Image Editing

## Paint







Draw on images or decorate them. Shooting date decoration can also be added. Painted copies are saved as separate files.

- 1 Select an image in full-frame playback mode (📖 82), tap the bottom tab to display the setting controls, and tap .



- 2 Use the , , , and  tools to paint images.

For more information about using each tool, see “Write and Draw on Images” (📖 116).

Tap  to display the image in full-frame playback mode and tap  again to enlarge the image display by 3x. Tap , , , or  to change the portion of the image that is displayed in the monitor. Tap  to return to the original display size.

Tap  to undo the last operation applied using the pen, eraser, or decoration tool (up to the last five operations can be undone).

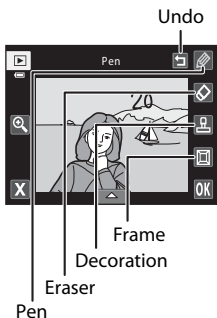

- 3 Tap **OK**.



## 4 Tap Yes.

A new, painted copy is created.

Images captured at an **Image mode** setting (📖 45) of **3M 2048×1536** or larger are saved at a size of 2048 × 1536 and images captured at **PC 1024×768** or **VGA 640×480** are saved at a size of 640 × 480.

To exit without saving the copy, tap **No**.

Painted copies can be identified by the 🖋 icon displayed during playback.



## Using the Paint Tools

### Write and Draw on Images

Tap 🖋 to write or draw on images.

To change the pens' color or thickness, tap the bottom tab to display the screen shown on the right.

- Tap or drag the pen's color slider to select pen's color.
- Tap the pen's thickness slider to select pen's thickness.

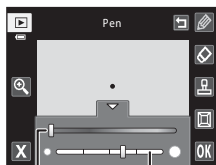

Pen's  
color

Pen's  
thickness

### Erase Paint Tool Additions

Tap ✖ to erase additions to images using the paint or decoration tool.

To change the eraser's size, tap the bottom tab to display the screen shown on the right.

- Tap the eraser's size slider to select the size of the eraser.

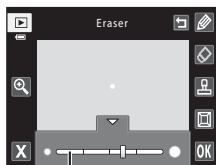



Eraser's size



## Add Decorations

Tap  to add a decoration.

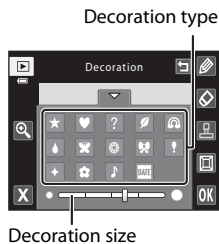

To change the decoration type or size, tap the bottom tab to display the screen shown on the right.

- Decoration type can be selected from 14 types.
- Tap the decoration size slider to select the decoration size.
- When  is selected for the decoration type,  (day, month, year) and  (day, month, year, time) options are available.





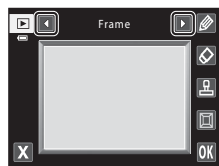

## Add a Frame

Tap  to add a frame around the image.

- Tap  or  to display seven different frames one at a time. Tap  to select a frame.



## ✓ Notes on Shooting Date Decoration



- When the shooting date decoration is added to images captured at an **Image mode** setting ( 45) of  **640×480**, the shooting date may be difficult to read. Set **Image mode** to  **1024×768** or larger when shooting.
- The date added with the shooting date decoration uses the format selected for **Date format** ( 152) in **Time zone and date** in the setup menu.
- The date and time added with the shooting date decoration are the date and time at which the image was captured. These cannot be changed.

## More Information

See “File and Folder Names” ( 178) for more information.

## Quick Retouch: Enhancing Contrast and Saturation

Quick retouch can be used to easily create retouched copies in which contrast and saturation have been enhanced. Copies created with the quick retouch function are saved as separate files.

- 1 Select an image in full-frame playback mode ( 82), tap the bottom tab to display the setting controls, and tap .

The retouch menu is displayed.

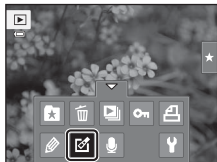

- 2 Tap .

The screen for selecting the degree of enhancement is displayed.

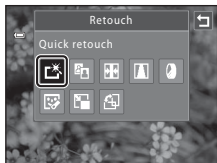

- 3 Choose the degree of enhancement performed and tap .



- 4 Tap **Yes**.

A new retouched copy is created.

To exit without saving the copy, tap **No**.

Copies created with the quick retouch option can be identified by the  icon displayed in playback mode.





### More Information

See “File and Folder Names” ( 178) for more information.

## D-Lighting: Enhancing Brightness and Contrast

D-Lighting can be used to create copies with enhanced brightness and contrast, brightening dark portions of an image. New copies are saved as separate files.

- 1 Select an image in full-frame playback mode ( 82), tap the bottom tab to display the setting controls, and tap .

The retouch menu is displayed.



- 2 Tap .

The original version will be shown on the left and the edited version will be shown on the right.



- 3 Tap .

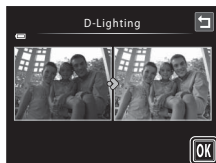

- 4 Tap **Yes**.

A new, edited copy is created.

To exit without saving the copy, tap **No**.

Copies created with the D-Lighting function can be identified by the  icon displayed in playback mode.





### More Information

See “File and Folder Names” ( 178) for more information.

## Stretch: Stretching Images

Stretch images horizontally. Stretched copies are saved as separate files.

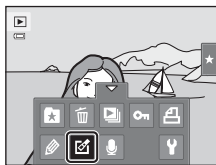

- 1 Select an image in full-frame playback mode ( 82), tap the bottom tab to display the setting controls, and tap .

The retouch menu is displayed.

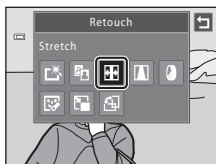

- 2 Tap .



- 3 Tap  or , or tap or drag the slider at the bottom of the screen to adjust stretch effect.

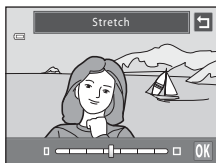

- 4 Tap .

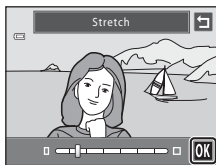

- 5 Tap **Yes**.

A new, stretched copy is created.

To exit without saving the copy, tap **No**.

Stretched copies can be identified by the  icon displayed in playback mode.





### More Information

See "File and Folder Names" ( 178) for more information.

## Perspective Control: Adjusting a Sense of Perspective

Adjust the sense of perspective in the image captured in landscape orientation. Copies created with the perspective control function are saved as separate files.

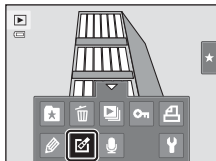

- 1 Select an image in full-frame playback mode ( 82), tap the bottom tab to display the setting controls, and tap .

The retouch menu is displayed.

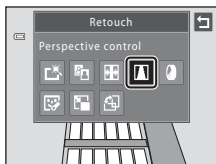

- 2 Tap .



- 3 Tap  or , or tap or drag the slider at the bottom of the screen to adjust perspective control.

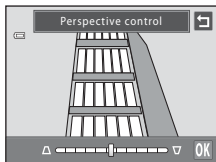

- 4 Tap .

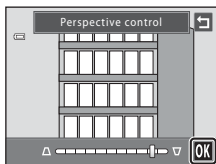

- 5 Tap **Yes**.

A new, edited copy is created.

To exit without saving the copy, tap **No**.

Copies created using the perspective control function can be identified by the  icon displayed in playback mode.

### More Information

See "File and Folder Names" ( 178) for more information.

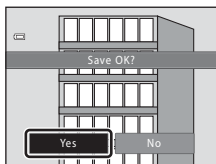

## Filter Effects (Digital Filter)

Apply a variety of effects using digital filter. The available effects are **Color options**, **Soft**, **Selective color**, **Cross screen**, **Fisheye**, or **Miniature effect**. New copies are saved as separate files.

- 1 Select an image in full-frame playback mode (82), tap the bottom tab to display the setting controls, and tap .

The retouch menu is displayed.





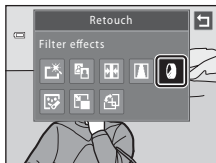

- 2 Tap .



- 3 Tap  or  to select the type of the effects.



Type	Description
Color options	Modify color tones. <ul style="list-style-type: none"> <li>• Select option from  (vivid color),  (black-and-white),  (sepia), or  (cyanotype), and tap .</li> </ul>



Type	Description
Soft	<p>Give the image a soft look by blurring the area surrounding the point that is tapped.</p> <ul style="list-style-type: none"> <li>Tap the monitor, select the degree of effects, and tap <b>OK</b>.</li> </ul>
Selective color	<p>Keep one specified color in the image, and change the other colors to black and white.</p> <ul style="list-style-type: none"> <li>Tap the color slider displayed on the screen to select the color to keep, and tap <b>OK</b>.</li> </ul>
Cross screen	<p>Produce star-like rays of light that radiate outward from bright objects such as sunlight reflections and city lights. This effect is suitable for night scenes.</p> <ul style="list-style-type: none"> <li>Confirm the degree of enhancement, and tap <b>OK</b>.</li> </ul>
Fisheye	<p>Make an image look as if it were captured with a fisheye lens. This effect is well-suited for images captured in macro mode.</p> <ul style="list-style-type: none"> <li>Confirm the degree of enhancement, and tap <b>OK</b>.</li> </ul>
Miniature effect	<p>Make an image look like a miniature scene captured in macro mode. This effect is well-suited for images captured from a high vantage point with the main subject at the center of the image.</p> <ul style="list-style-type: none"> <li>Confirm the degree of enhancement, and tap <b>OK</b>.</li> </ul>

A confirmation screen for saving the edited copy is displayed.

Tap  to return to the retouch menu without making any changes.

#### 4 Tap **Yes** in the confirmation dialog.

A new, edited copy is created.

To exit without saving the copy, tap **No**.

Copies created using the filter effects function can be identified by the  icon displayed in playback mode.





#### More Information

See "File and Folder Names" ( 178) for more information.

## Glamour Retouch

Glamour retouch can be used to soften the skin tone of faces detected in an image and make the faces look smaller with larger eyes. New copies are saved as separate files.

- 1 Select an image in full-frame playback mode ( 82), tap the bottom tab to display the setting controls, and tap .

The retouch menu is displayed.



- 2 Tap .

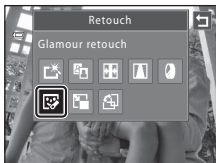

- 3 Tap  (skin softening) or  (both).

: Soften facial skin tones.

: Soften facial skin tones, make faces look smaller, and make eyes look larger.



The preview screen is displayed.



- 4 Preview the result of the effects.

Skin tones in up to 12 faces, in the order of that closest to the center of the frame, are softened.

Tap **Before** or **After** to view the image with or without the effects.

If more than one face was retouched, tap  or  to display a different face.

To change the effect, tap  to return to step 3.

Tap **OK** to display the confirmation dialog for saving the new copy.

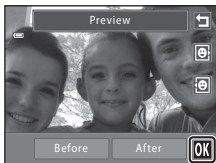



## 5 Tap **Yes**.

A new, edited copy is created.

To exit without saving the copy, tap **No**.

Copies created using the glamour retouch function can be identified by the  icon displayed in playback mode.





### **Notes on Glamour Retouch**

- If no faces are detected in the image, the glamour retouch function cannot be used.
- The glamour retouch function may not perform as expected depending on the direction in which the faces are looking or the brightness of the faces in the image.

### **More Information**

See "File and Folder Names" ( 178) for more information.

## **Small Picture: Decreasing Image Size**

Create a small copy of the current image. This feature is useful for creating copies for display on Web pages or e-mail attachments. Small copies are saved as JPEG files with a compression ratio of 1:16. The  **640×480**,  **320×240**, and  **160×120** sizes are available.

- 1** Select an image in full-frame playback mode (📖 82), tap the bottom tab to display the setting controls, and tap .

The retouch menu is displayed.



- 2** Tap .

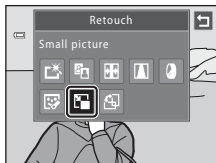

- 3** Tap the desired small copy size control and tap **OK**.



- 4** Tap **Yes**.

A new, small copy is created.

To exit without saving the copy, tap **No**.

The copy is displayed with a gray frame.





## **More Information**

See "File and Folder Names" (📖 178) for more information.

## ✂ Crop: Creating a Cropped Copy

Create a copy containing only the portion visible in the monitor when  is displayed with playback zoom ( 85) enabled. Cropped copies are saved as separate files.

- 1 Rotate the zoom control to **T** () in full-frame playback mode ( 82) to zoom in on the image.

To crop an image displayed in “tall” (portrait) orientation, zoom in on the image until the black bars displayed on the both sides of the monitor disappear. The cropped image will be displayed in landscape orientation.

To crop the image in its current “tall” (portrait) orientation, first rotate the image ( 110) so that it is displayed in landscape orientation. Next, enlarge the image for cropping, crop the image, and then rotate the cropped image back to “tall” (portrait) orientation.

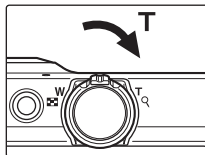

- 2 Refine crop composition.

Rotate the zoom control to **T** () or **W** () to adjust the zoom ratio.

Drag the image so that only the portion to be copied is visible in the monitor.



- 3 Tap .



- 4 Tap **Yes**.

A cropped copy is created.

To exit without saving the copy, tap **No**.

Copies created using the crop function can be identified by the  icon displayed in playback mode.



### Image Size

As the area to be saved is reduced, the image size (pixels) of the cropped copy is also reduced. When the size of the cropped copy is 320 × 240 or 160 × 120, a gray frame is displayed around the image, and the small picture icon () is displayed on the top of the screen in full-frame playback mode.

### More Information

See “File and Folder Names” ( 178) for more information.

## Recording Movies

High-definition movies with sound recorded via the built-in microphone can be recorded.

- The maximum movie length for a single movie is 29 minutes, even when there is sufficient free space on the memory card for longer recording (📖 131).
- When a memory card is not inserted (i.e., when the internal memory is used), **Movie options** (📖 130) is fixed at **VGA (640×480). HD 720p (1280×720)** cannot be selected.

### 1 Turn on the camera and be sure that it is in shooting mode.

Movie recording can be started in any shooting mode (except the draw option) (📖 41).



### 2 Press the **●** (📹 movie-record) button to start movie recording.

Recording begins after the monitor turns off briefly.

The camera focuses at the center of the frame. Focus areas are not displayed during recording.

When **HD 720p (1280×720)** (default setting) is selected for **Movie options** (📖 130), monitor display changes to an aspect ratio of 16:9 with movie recording (the area indicated on the right is recorded).

If the **Shooting** setting in **Monitor settings** (📖 155) in the setup menu is set to **View/hidden movie frm**, a frame is displayed before recording begins that represents the area that is captured when recording movies.

The approximate remaining movie length is displayed during recording.

Recording stops automatically when the maximum movie length has been recorded.

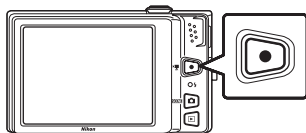

### 3 Press the **●** (📹 movie-record) button again to end recording.





#### ✔ Note on Saving Movies

After a movie has been recorded, it is not fully saved to the internal memory or memory card until monitor display returns to the shooting display. **Do not open the battery-chamber/memory card slot cover** before movies have been fully saved. Removing the memory card while movies are being saved could result in loss of data or in damage to the camera or card.

## ✓ Recording Movies

- Memory cards with an SD Speed Class rating of 6 or faster are recommended when recording movies (📖 177). Movie recording may stop unexpectedly when memory cards with a lower Speed Class ratings are used.
- There may be some degradation in image quality when digital zoom is used.
- When recording ends, digital zoom turns off.
- In some cases, movie recordings may capture the sounds of the camera, such as the sounds produced by the zoom control operation, the movement of the lens during auto focus or zoom, the vibration reduction function, or the aperture control when the brightness changes.
- Smear (📖 175) visible in the monitor with movie recording will be recorded with movies. Avoiding bright objects such as the sun, reflections of the sun, and electric lights when recording movies is recommended.
- When recording or playing back movies, colored stripes (interference patterns or moiré) may appear on subjects that have a regular, repeating grid, such as pattern of weave in cloths or windows in a building, depending on the shooting distance or zoom ratio. This phenomenon occurs when the subject's pattern interferes with the camera sensor grid, and it does not indicate a malfunction.



## ✓ Notes on Autofocus for Movie Recording

- When  **Single AF** (default setting) is selected for **Movie AF mode**, focus is locked by pressing the  to start recording (📖 131).
- Autofocus may not perform as expected (📖 31). Should this occur, try the following:
  1. Set **Movie AF mode** to  **Single AF** (default setting) before starting movie recording.
  2. Frame a different subject (positioned at the same distance from the camera as the intended subject) in the center of the frame, press the  to start recording, and then modify the composition.

## ✓ Camera Temperature

The camera may become warm when shooting movies for an extended period of time or when the camera is used in a hot area; this is not a malfunction.

## 📎 Functions Available with Movie Recording

- Current exposure compensation setting, white balance setting specified for  (auto) mode, and the scene effect adjustment slider specified for scene mode setting are also applied with movie recording. When macro mode is enabled, movies of subjects closer to the camera can be recorded. Confirm settings before starting movie recording.
- The self-timer (📖 37) can be used. When the  button is pressed after the self-timer is enabled, the camera focuses on the center of the frame and movie recording starts ten or two seconds later.
- The flash will not fire.
- The **Movie options**, **Movie AF mode**, or **Wind noise reduction** setting can be made before starting movie recording (📖 130).

## Changing the Movie Recording Settings

The movie settings described below can be made. Apply the settings before starting movie recording.

### Movie options 📖 130

Select the desired movie option for recording movies.

### Movie AF mode 📖 131

Choose how the camera focuses when recording movies.



### Wind noise reduction 📖 132

Set whether or not to reduce wind noise during movie recording.

## Movie Options

In the shooting screen → Tap the bottom tab (📖 14) →  Movie options



Select the desired movie option to record. Larger image sizes and faster movie bit rates mean greater image quality and larger movie file sizes.

Option	Description
 HD 720p (1280×720) (default setting*)	Movies with an aspect ratio of 16:9 are recorded in high definition. This option is suited to playback on a wide screen TV. <ul style="list-style-type: none"> <li>• Image size: 1280 × 720 pixels</li> <li>• Movie bit rate: 9.1 Mbps</li> </ul>
 VGA (640×480)	Movies with an aspect ratio of 4:3 are recorded. <ul style="list-style-type: none"> <li>• Image size: 640 × 480 pixels</li> <li>• Movie bit rate: 3.1 Mbps</li> </ul>

\* When a memory card is not inserted (i.e., when the internal memory is used), the setting is fixed at  **VGA (640×480)**.

- The movie bit rate is the volume of movie data recorded per second. As a variable bit rate (VBR) system has been adopted, the movie recording rate varies automatically according to the subject so that more data is recorded per second for movies containing frequently moving subjects, thus increasing movie file size.
- The frame rate is approximately 30 frames per second in any options.

## Movie Options and Maximum Movie Length

Option	Internal memory (approx. 20 MB)	Memory card <sup>2</sup> (4 GB)
 HD 720p (1280×720)	— <sup>1</sup>	55 min
 VGA (640×480)	29 s	2 h 45 min

All figures are approximate. The maximum movie length may vary by make of memory card or movie bit rate.

<sup>1</sup> When the internal memory is used,  **HD 720p (1280×720)** cannot be selected.

<sup>2</sup> The maximum movie length for a single movie is 29 minutes. The maximum movie length displayed during recording is 29 minutes, even when there is enough free space on the memory card for a longer movie.



## More Information

See “File and Folder Names” (📖 178) for more information.

## Movie AF Mode

In the shooting screen → Tap the bottom tab (📖 14) →  Movie AF mode

Choose how the camera focuses with recording movies.

Option	Description
 <b>Single AF</b> (default setting)	Focus is locked when the ● (📷 movie-record) button is pressed to start recording. Select this option when the distance between the camera and the subject will remain fairly consistent.
 <b>Full-time AF</b>	Camera focuses continuously during movie recording. Select this option when the distance between the camera and the subject will change. To prevent the sound of the camera focusing from interfering with recording, use of <b>Single AF</b> is recommended.

 **Wind Noise Reduction**

In the shooting screen → Tap the bottom tab (📖 14) →  Wind noise reduction

Set whether or not to reduce wind noise during movie recording.

Option	Description
 On	Reduces the sound heard when wind passes over the microphone. Use when recording movies in locations with strong winds. Other sounds may become difficult to hear during playback.
OFF Off (default setting)	Wind noise reduction is not enabled.



# Movie Playback

In full-frame playback mode (📖 82), movies can be identified by 🎬 icon. Tap 🎬 to play a movie.

To adjust the volume before playback, tap the bottom tab to display the setting controls and tap 🔊.

Rotate the zoom control to **T** or **W** during playback to adjust playback volume. Tap the monitor during playback to display the playback control panel at the bottom in the monitor.

Tap a playback control to perform the corresponding operation. The operations described below are available.



During playback



Function	Icon	Description
Volume	🔊	Tap 🔊 to adjust volume.
Rewind	⏮	Touch and hold ⏮ to rewind movie.
Advance	⏭	Touch and hold ⏭ to advance movie.
Pause	⏸	Tap ⏸ to pause playback. The following operations can be performed while playback is paused.
		Tap ⏮ to rewind movie one frame. Touch and hold ⏮ for continuous rewinding.
		Tap ⏭ to advance movie one frame. Touch and hold ⏭ for continuous advancing.
End	⏹	Tap ⏹ to end movie playback and return to full-frame playback mode.

## ✔ Movie Playback

Movies recorded by a camera other than the COOLPIX S6100 cannot be played back.

## ✂ Deleting Movie

See "Deleting Unwanted Images" (📖 33) for more information.

## Connecting to a TV

Connect the camera to a television to play images or movies back on the television. If your TV is equipped with an HDMI jack, a commercially available HDMI cable can be used to connect the camera to the TV for high-definition display.

- 1 Turn off the camera.

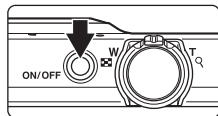

- 2 Connect the camera to the TV.

### When using the supplied audio/video cable

Connect the yellow plug to the video-in jack and the white and red plugs to the audio-in jacks on the TV.

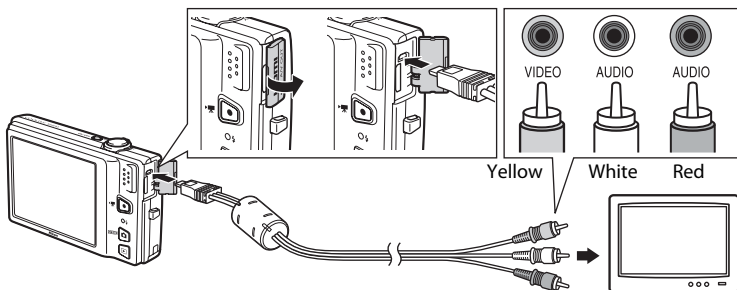

### When using a commercially available HDMI cable

Connect the plug to the HDMI jack on the TV.

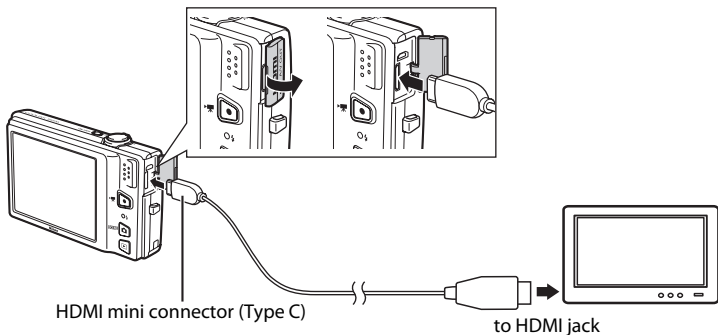

### 3 Tune the television to the video channel.

See the documentation provided with your television for details.

### 4 Hold down the button to turn on the camera.



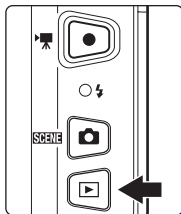

The camera enters playback mode and images are displayed on the television.

The camera monitor turns off when images are displayed on the television.

See "Operations with TV Connection" ( 136) for more information.





### Notes on Connecting the HDMI Cable

- HDMI cable is not provided. Use a commercially available HDMI cable to connect the camera to a high-definition TV. The output terminal on this camera is an HDMI mini connector (type C). When purchasing an HDMI cable, be sure that the device end of the cable is an HDMI mini connector.
- **Image mode** ( 45) settings of  **2048 x 1536** or higher and **Movie options** ( 130) settings of  **HD 720p (1280 x 720)** or higher are recommended for images or movies that will be played back on a TV via HDMI connection.

### Connecting the Audio/Video Cable

- When connecting the audio/video cable, be sure that the camera connector is properly oriented. Do not use force when connecting the audio/video cable to the camera. When disconnecting the audio/video cable, do not pull the connector at an angle.
- Do not connect cables to the HDMI mini connector (Type C) and to the USB/audio/video output connector simultaneously.

### Video Mode

Be sure that the camera's **TV settings** setting ( 164) in the **Set up** menu ( 149) conforms to the standard used by your television.

### Operations with TV Connection

While images are displayed full-frame on the TV, the previous or next image can be viewed by dragging your finger across the camera monitor.

- By operating the zoom control, images can be displayed as thumbnails (📖 83) and image display can be enlarged (📖 85).
- When the first frame of a movie is displayed, the movie can be played back by holding your finger on the camera monitor and removing it after about one second.
- Tap the camera monitor to turn TV display off and display the image in the camera monitor. When images are displayed in the camera monitor, tap the controls displayed to operate the camera.
- Images will be automatically displayed on the TV in the following situations.
  - No operations are performed for a few seconds.
  - A slide show is played back.
  - A movie is played back.

### Using a TV Remote Control (HDMI Device Control)

The remote control of an HDMI-CEC-compatible TV can be used to control playback. Image selection, movie playback and pause, and switching between full-frame playback mode and 4-image thumbnail display mode are available.

- Set the **HDMI device control** setting (📖 164) of **TV settings** to **On** (default setting) and then connect the camera and TV using an HDMI cable.
- Aim the remote control at the TV when operating it.
- Refer to the TVs operating instructions for information about the TVs HDMI-CEC compatibility.

## Connecting to a Computer

Use the supplied USB cable to connect the camera to a computer and copy (transfer) images to the computer.

### Before Connecting the Camera

#### Install the Software

Use the supplied ViewNX 2 CD and install the following software on the computer. For more information on installing the software, refer to the *Quick Start Guide*.

- ViewNX 2: Use the image transfer feature “Nikon Transfer 2” to save images that were captured with the camera on the computer. Saved images can be viewed and printed. Image and movie editing features are also supported.
- Panorama Maker 5: This software can join a series of images to create a single panorama image.

#### Compatible Operating Systems

##### Windows

Windows 7 Home Basic/Home Premium/Professional/Enterprise/Ultimate, Windows Vista Home Basic/Home Premium/Business/Enterprise/Ultimate (Service Pack 2), or Windows XP Home Edition/Professional (Service Pack 3)

##### Macintosh

Mac OS X (version 10.4.11, 10.5.8, 10.6.5)

For information on the requirements for playing back high-definition movies, refer to “System Requirements” in the ViewNX 2 help information (📖 141).

Refer to the Nikon website for the latest information on operating system compatibility.

#### Note on Computer Connection

Disconnect other USB devices such as commercial USB chargers from the computer. Simultaneous connection of the camera and other USB devices to the computer could result in operation malfunction or excessive supply of power to the camera, causing damage to the camera or memory card. Refer to the documentation supplied with other USB devices for more information.

## Connecting to a Computer

### ✔ Notes on Power Source

- When connecting the camera to a computer, use a battery with a sufficient amount of charge remaining to prevent the camera from turning off unexpectedly.
- When the camera is connected to a computer via the supplied USB cable with **Auto** (default setting) selected for the **Charge by computer** option in the setup menu, the battery inserted into the camera is automatically charged using power supplied by the computer (142, 165).
- If the AC Adapter EH-62F (176) (available separately) is used, COOLPIX S6100 can be powered from an electrical outlet. Do not use any other make or model of AC adapter as they may cause the camera to overheat or malfunction.

## Transferring Images from a Camera to a Computer

- 1 Start the computer to which ViewNX 2 was installed.
- 2 Be sure that the camera is off.
- 3 Connect the camera to the computer using the supplied USB cable.

Be sure that connectors are properly oriented. Do not attempt to insert connectors at an angle, and do not use force when connecting or disconnecting the USB cable.

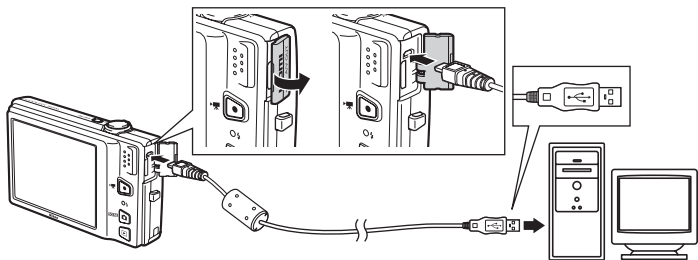

The camera is automatically turned on and the power-on lamp will light. The camera monitor will remain off.

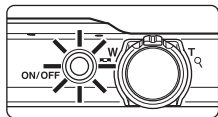

### ✔ Connecting the USB Cable

The connection may not be recognized if the camera is connected to the computer via a USB hub.

## 4 Start the ViewNX 2 image transfer feature “Nikon Transfer 2” installed on the computer.

### • Windows 7

When the **Devices and Printers ▶ S6100** screen is displayed, click **Change program** under **Import pictures and videos**. Select **Import File using Nikon Transfer 2** in the **Change program** dialog and click **OK**.

Double-click **Import File** on the **Devices and Printers ▶ S6100** screen.

### • Windows Vista

When the **AutoPlay** dialog is displayed, click **Import File using Nikon Transfer 2**.

### • Windows XP

When the action selection dialog is displayed, select **Nikon Transfer 2 Import File**, and click **OK**.

### • Mac OS X

Nikon Transfer 2 will start automatically when the camera is connected to the computer if **Yes** was selected in the **Auto-Launch setting** dialog when ViewNX 2 was first installed.

• See “Starting Nikon Transfer 2 Manually” (📖 141) for more information.

- If charge for the battery inserted into the camera is low, the computer may not recognize the camera. If the camera is not recognized, images will not be transferred. When battery charging starts automatically using power supplied by the computer, wait until battery charge has reached a sufficient level to begin transfer.
- If there are a large number of images on the memory card, it may take some time for Nikon Transfer 2 to start.

## 5 Confirm that the source device is displayed in the transfer options **Source** panel and click **Start Transfer**.

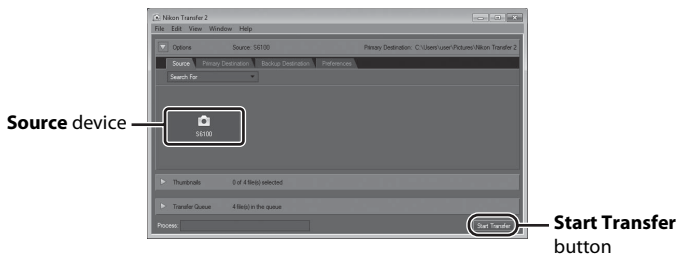

Any images that have not been transferred to the computer will be transferred (default setting of ViewNX 2).

## Connecting to a Computer

When transfer is complete, the ViewNX 2 screen is displayed (ViewNX 2 default setting) and transferred images are displayed.

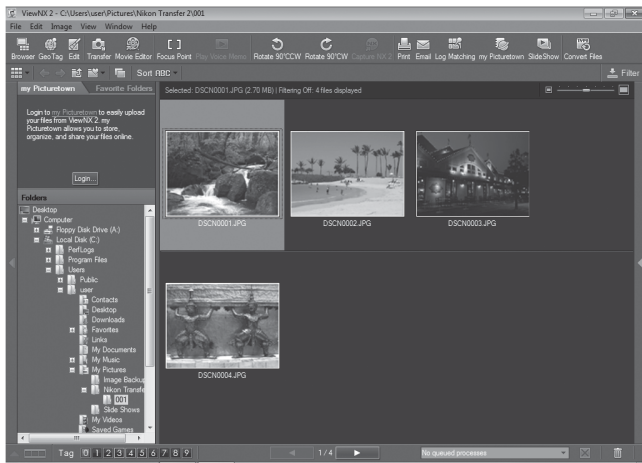

For more information on using ViewNX 2, refer to the ViewNX 2 help information (141).

## Disconnecting the Camera

Do not turn off the camera or disconnect the camera from the computer during transfer.

When transfer is complete, turn off the camera and disconnect the USB cable.

The camera turns off automatically if there is no communication with the computer for 30 minutes while the camera is connected via the USB cable.

## Charging the Battery

The charge lamp slowly blinks green while the battery inserted into the camera is charging (142).



## Transferring Images Using a Computer's Card Slot or a Commercially-available Card Reader

When the memory card is inserted into a computer's card slot or into a commercially-available card reader, the images can be transferred using "Nikon Transfer 2", the image transfer feature of ViewNX 2.

- Make sure that the memory card being used is supported by the card reader or other card reading device.
- To transfer images, insert the memory card into the card reader or card slot and follow the procedure from step 4 (📖 139).
- To transfer images saved in the camera's internal memory, the images must first be copied to a memory card using the camera (📖 171).

## Starting ViewNX 2 Manually

### Windows

Choose **Start** menu > **All Programs** > **ViewNX 2** > **ViewNX 2**.

Double-clicking the **ViewNX 2** shortcut icon on the desktop will also start ViewNX 2.

### Mac OS X

Open the **Applications** folder, open the **Nikon Software** > **ViewNX 2** folders in that order, and then double-click the **ViewNX 2** icon. Clicking the **ViewNX 2** icon on the Dock will also start ViewNX 2.

## Starting Nikon Transfer 2 Manually

To start Nikon Transfer 2, first start ViewNX 2, and then click the **Transfer** icon at the top of the screen or select **Launch Transfer** from the **File** menu.

## For More Information on Using ViewNX 2 and Nikon Transfer 2

For more information on ViewNX 2 or Nikon Transfer 2, start ViewNX 2 or Nikon Transfer 2 and select **ViewNX 2 Help** from the **Help** menu.

## Panorama Creation with Panorama Maker 5

- Use a series of images captured in **Panorama assist** scene mode (📖 74) to create a single panorama photo with Panorama Maker 5.
- Panorama Maker 5 can be installed on a computer using the supplied ViewNX 2 CD.
- After installation is complete, follow the procedure described below to start Panorama Maker 5.

### Windows

Choose **Start** menu > **All Programs** > **ArcSoft Panorama Maker 5** > **Panorama Maker 5**.

### Mac OS X

Open **Applications** and double-click the **Panorama Maker 5** icon.

- For more information on using Panorama Maker 5, refer to the on-screen instructions and help information contained in Panorama Maker 5.

## Image File Names and Folder Names

See "File and Folder Names" (📖 178) for more information.

## Charging While Connecting to a Computer

When the **Charge by computer** option (📖 165) in the camera's setup menu is set to **Auto** (default setting), if the camera is connected to a computer using the USB cable, the battery inserted into the camera can be automatically charged depending on the ability of the computer to supply power.

See "Before Connecting the Camera" (📖 137) and "Transferring Images from a Camera to a Computer" (📖 138) for more information on connecting the camera to a computer.

### Charge Lamp

The following chart explains charge lamp status when the camera is connected to a computer.

Charge lamp	Description
Blinks slowly (green)	Battery charging.
Off	Battery not charging. If the charge lamp changes from slow blinking (green) to off while the power-on lamp is lit, charging is complete.
Flickers (green)	<ul style="list-style-type: none"> <li>The ambient temperature is not suited to charging. Charge the battery indoors with an ambient temperature of 5 °C to 35 °C (41 °F to 95 °F).</li> <li>A USB cable is not correctly connected or the battery is faulty. Reconnect the USB cable correctly or replace the battery.</li> <li>Computer is in sleep mode and does not supply power. Reboot the computer.</li> <li>The battery cannot be charged as computer's specifications or settings does not support power supply to the camera.</li> </ul>

### ✓ Notes on Charging with Connection to a Computer

- The battery cannot be charged, nor can data be transferred, when the camera is connected to a computer before the camera's display language and date and time have been set (📖 22). If the camera's clock battery (📖 153) has been exhausted, the date and time must be reset before the battery can be charged or images can be transferred with connection to a computer. In this case, use the Charging AC Adapter EH-69P (📖 18) to charge the battery and then set the camera's date and time.
- If the camera is turned off, charging will also stop.
- If a computer enters sleep mode while charging, charging will stop and the camera may be turned off.
- When disconnecting the camera from a computer, turn the camera off and then disconnect the USB cable.
- About 3 hours and 50 minutes are required to charge a fully exhausted battery. Charging time increases when images are transferred while the battery is charging.
- When the camera is connected to a computer, an application installed on the computer, such as Nikon Transfer 2, may start. If the camera was connected to the computer for the sole purpose of charging the battery, exit the application.
- The camera turns off automatically if there is no communication with the computer for 30 minutes after the battery has finished charging.
- Depending upon computer specifications, settings, and power supply and allocation, it may be impossible to charge the battery inserted into the camera via computer connection.

## Connecting to a Printer

Users of PictBridge-compatible (📖 196) printers can connect the camera directly to the printer and print images without using a computer. Follow the procedures below to print images.

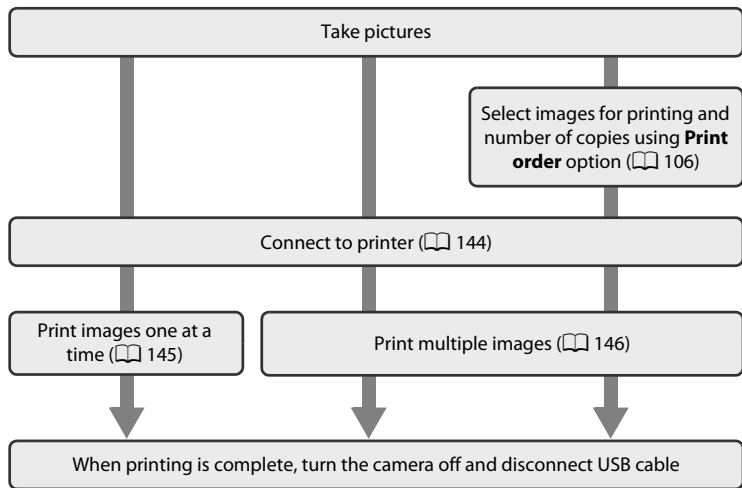

### ✓ Notes on Power Source

- When connecting the camera to a printer, use a fully charged battery to prevent the camera from turning off unexpectedly.
- If the AC Adapter EH-62F (available separately) is used, COOLPIX S6100 can be powered from an electrical outlet. Do not use any other make or model of AC adapter as they may cause the camera to overheat or malfunction.

### 🔍 Printing Images

In addition to printing images transferred to a computer from your personal printer and printing over a direct camera-to-printer connection, the following options are also available for printing images:

- Inserting a memory card into a DPOF-compatible printer's card slot
- Taking a memory card to a digital photo lab

For printing using these methods, specify the images and the number of prints each to the memory card using the **Print order** menu (📖 106).

## Connecting the Camera to a Printer

- 1 Turn off the camera.

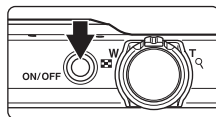

- 2 Turn on the printer.

Check printer settings.

- 3 Connect the camera to the printer using the supplied USB cable.

Be sure that connectors are properly oriented. Do not attempt to insert connectors at an angle, and do not use force when connecting or disconnecting the USB cable.

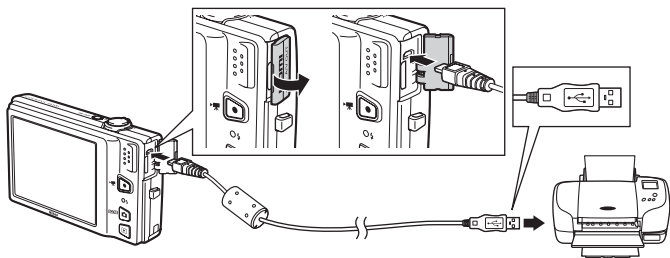

- 4 The camera is automatically turned on.

When properly connected, the **PictBridge** startup screen (①) will be displayed in the camera monitor, followed by the **Print selection** screen (②).

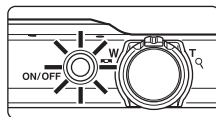

### ✔ If the PictBridge Startup Screen Is Not Displayed

Turn the camera off and disconnect the USB cable. Set the **Charge by computer** option (📖 165) in the camera's setup menu to **Off** and reconnect the cable.

## Printing Images One at a Time

After properly connecting the camera to the printer (📖 144), follow the procedure described below to print an image.

- 1 Tap **▲** or **▼** to choose the desired image and tap **OK**.

Tap **🔍** or rotate the zoom control to **W** (🗍) to switch to 9-thumbnail display. Tap **🔍** or rotate the zoom control to **T** (📺) to switch back to full-frame playback.

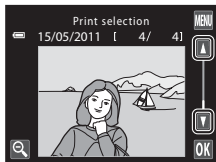

- 2 Tap **Copies**.



- 3 Tap the desired number of copies (up to nine).



- 4 Tap **Paper size**.

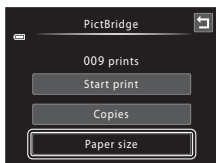

- 5 Tap the desired paper size.

Tap **▲** or **▼** to display additional options.

To specify paper size using printer settings, choose **Default** in the paper size menu.

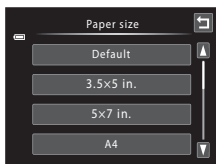

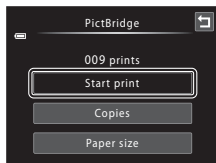
**6** Tap **Start print.****7** Printing begins.

Monitor display returns to the print selection screen shown in step 1 when printing is complete.

To cancel printing before all copies have been printed, tap **Cancel**.



Current number of copies/  
total number of prints

**Printing Multiple Images**

After properly connecting the camera to the printer (📖 144), follow the procedure described below to print multiple images.

**1** When the **Print selection** screen is displayed, tap **MENU**.

The **Print menu** screen is displayed.

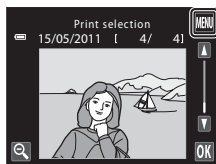
**2** Tap **Paper size.**

To exit the print menu, tap **OK**.



### 3 Tap the desired paper size.

Tap **A** or **I** to display additional options.

To specify paper size using printer settings, choose **Default** in the paper size option.

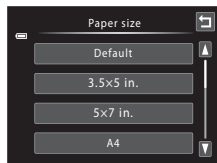

### 4 Tap **Print selection**, **Print all images**, or **DPOF printing**.

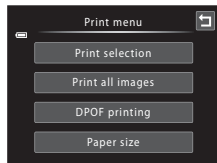

#### Print selection

Choose images (up to 99) and the number of copies (up to nine) of each.

- Tap the desired image and tap **+** or **-** at the upper left in the monitor to specify the number of copies to be printed.
- Images selected for printing can be identified by the check mark (✓) and the numeral indicating the number of copies to be printed. If no copies have been specified for images, the selection is canceled.
- Tap **T** (🔍) or rotate the zoom control to **T** (🔍) to switch to full-frame playback. Tap **W** (🔍) or rotate the zoom control to **W** (🔍) to switch back to 9-thumbnail display.
- Tap **Cancel** to cancel the selection of all images.
- Tap **OK** when setting is complete.
- When the screen shown on the right is displayed, tap **Start print** to start printing. Tap **Cancel** to return to the print menu.

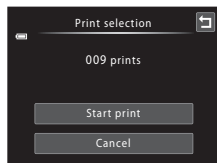

### Print all images

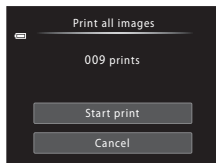

One copy each of all images saved in the internal memory, or on the memory card, is printed.

- When the screen shown on the right is displayed, tap **Start print** to start printing. Tap **Cancel** to return to the print menu.



### DPOF printing

Print images for which a print order was created using the **Print order** option (📖 106).

- When the screen shown on the right is displayed, tap **Start print** to start printing. Tap  to return to the print menu.
- To view the current print order, tap **View images**. To print images, tap .

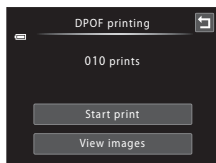

## 5 Printing begins.

Monitor display returns to the print menu (step 2) when printing is complete.

To cancel printing before all copies have been printed, tap **Cancel**.



Current number of copies/  
total number of prints

### Paper Size















The camera supports the following paper sizes: **Default** (the default paper size for the printer connected to the camera), **3.5x5 in.**, **5x7 in.**, **100x150 mm**, **4x6 in.**, **8x10 in.**, **Letter**, **A3**, and **A4**.

Only sizes supported by the printer will be displayed. To specify paper size using printer settings, choose **Default** in the paper size option.







## Setup Menu

The setup menu contains the following options.

	<b>Welcome screen</b> <span style="float: right;">📖 151</span>
	Choose whether or not a welcome screen is displayed when camera is turned on.
	<b>Time zone and date</b> <span style="float: right;">📖 152</span>
	Set camera clock and choose home and destination time zones.
	<b>Monitor settings</b> <span style="float: right;">📖 155</span>
	Set the photo information that is displayed during shooting, during playback, and after shooting, and also adjust the monitor brightness.
	<b>Print date</b> <span style="float: right;">📖 157</span>
	Imprint shooting date and time on images.
	<b>Vibration reduction</b> <span style="float: right;">📖 158</span>
	Choose whether or not vibration reduction is enabled.
	<b>Motion detection</b> <span style="float: right;">📖 159</span>
	Enable or disable motion detection, which reduces the effects of subject movement and camera shake in still images.
	<b>AF assist</b> <span style="float: right;">📖 160</span>
	Enable or disable AF-assist illuminator.
	<b>Digital zoom</b> <span style="float: right;">📖 160</span>
	Enable or disable digital zoom.
	<b>Sound settings</b> <span style="float: right;">📖 161</span>
	Adjust sound settings.
	<b>Auto off</b> <span style="float: right;">📖 162</span>
	Set time before the monitor turns off for saving power.
	<b>Format memory/Format card</b> <span style="float: right;">📖 163</span>
	Format internal memory or memory card.
	<b>Language</b> <span style="float: right;">📖 164</span>
	Choose the language used for camera monitor display.
	<b>TV settings</b> <span style="float: right;">📖 164</span>
	Adjust settings necessary for connection to television.
	<b>Charge by computer</b> <span style="float: right;">📖 165</span>
	Choose whether or not to charge the camera battery when connecting to a computer via the USB cable.

## Setup Menu

	<b>Blink warning</b> <span style="float: right;">📖 166</span>
Specify whether or not the camera detects if the eyes of a face that is detected at the time of shooting are blinking.	
	<b>Reset all</b> <span style="float: right;">📖 168</span>
Restore camera settings to default values.	
	<b>Copy</b> <span style="float: right;">📖 171</span>
Copy files between memory card and internal memory.	
	<b>Firmware version</b> <span style="float: right;">📖 172</span>
Display camera firmware version.	

## Operating the Setup Menu

- 1 Tap the bottom tab in shooting or playback mode.

See "Operating the Tabs" (📖 14) for more information.





- 2 Tap .



The setup menu is displayed.



- 3 Tap the desired option.

Tap  or  to display previous or next page.

Tap  to return to the previous screen.

When  is displayed in a screen, tap  to apply the setting.

To exit the setup menu, tap  or press the shutter-release button (when shooting).

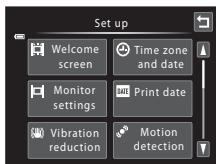

## 📷 Welcome Screen

Tap the bottom tab (📖 150) → Tap 📷 (Setup menu) → 📷 Welcome screen

Choose whether or not a welcome screen is displayed when the camera is turned on.

### None (default setting)

The camera enters shooting or playback mode without displaying the welcome screen.

### COOLPIX

The camera displays a welcome screen and enters shooting or playback mode.

### Select an image

Displays an image selected for the welcome screen. When the **Select image** screen is displayed, select an image and tap **OK**.

- In the **Select image** screen, tap 📷 or rotate the zoom control to **T** (📷) to switch to full-frame playback and tap 📷 or rotate the zoom control to **W** (📷) to switch back to 9-thumbnail display.
- As the selected image is saved by the camera, it will be displayed when the camera is turned on even if the original image is deleted.
- Images captured at an **Image mode** setting (📖 45) of 📷 **4608x2592**, and copies created at a size of 320 x 240 or smaller using small picture (📖 126) or the crop (📖 127) function, cannot be used.

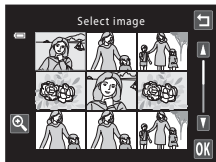

## ⌚ Time Zone and Date

Tap the bottom tab (📖 150) → Tap 🛠️ (Setup menu) → ⌚ Time zone and date

Set the camera clock.

### Date and time

Set camera clock to current date and time.

Tap the items (day, month, year, hour, or minute) on the displayed screen to set the date and time.

- Select the item: tap the desired item.
- Edit the highlighted item: tap ⬆️ or ⬆️.
- Apply the setting: tap **OK**.

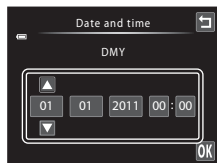

### Date format

The available date formats are **Year/Month/Day**, **Month/Day/Year**, and **Day/Month/Year**.

### Time zone

🏠 Home time zone can be specified and daylight saving time is enabled or disabled from Time zone options. When the destination time zone (🌐) is selected, local time (📖 154) is automatically calculated and the date and time in the selected region are saved with images. Useful when traveling.

## Selecting Travel Destination Time Zone

### 1 Tap **Time zone**.

The **Time zone** menu is displayed.

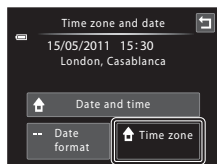

### 2 Tap ➔ **Travel destination**.

The date and time displayed in the monitor changes according to the region currently selected.

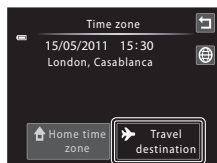

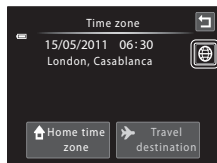

### 3 Tap .

The time zone selection screen is displayed.



### 4 Tap or to choose the travel destination time zone and tap **OK**.

If daylight saving time is in effect, tap  to enable daylight saving time function.  is displayed at the top of the monitor and the camera clock is advanced one hour. Tap  again to disable the daylight saving time function.

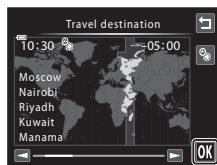



While the travel destination time zone is selected, the  icon will be displayed in the monitor when the camera is in shooting mode.

### **Note on the Clock Battery**

The camera clock is powered by the clock battery. The clock battery charges when the main battery is inserted or an AC adapter is connected, and can provide several days of backup power after about ten hours of charging.

### **Home Time Zone**

- To switch to the home time zone, tap  **Home time zone** in step 2.
- To change the home time zone, tap  **Home time zone** in step 2 and complete steps 3 and 4.

### **Daylight Saving Time**

When daylight saving time starts or ends, turn the daylight saving time option on or off from the time zone selection screen displayed in step 4.

### **Imprinting Date on Images**

Enable date imprint from the **Print date** option ( 157) in the setup menu after the date and time have been set. When the **Print date** option is enabled, images will be saved with shooting date imprinted on them.

 **Time Zones**

The camera supports the time zones listed below.

For time zones not listed below, set the camera clock to local time from the **Date and time** option.

UTC +/-	Location	UTC +/-	Location
-11	Midway, Samoa	+1	Madrid, Paris, Berlin
-10	Hawaii, Tahiti	+2	Athens, Helsinki, Ankara
-9	Alaska, Anchorage	+3	Moscow, Nairobi, Riyadh, Kuwait, Manama
-8	PST (PDT): Los Angeles, Seattle, Vancouver	+4	Abu Dhabi, Dubai
-7	MST (MDT): Denver, Phoenix	+5	Islamabad, Karachi
-6	CST (CDT): Chicago, Houston, Mexico City	+5.5	New Delhi
-5	EST (EDT): New York, Toronto, Lima	+6	Colombo, Dhaka
-4.5	Caracas	+7	Bangkok, Jakarta
-4	Manaus	+8	Beijing, Hong Kong, Singapore
-3	Buenos Aires, Sao Paulo	+9	Tokyo, Seoul
-2	Fernando de Noronha	+10	Sydney, Guam
-1	Azores	+11	New Caledonia
±0	London, Casablanca	+12	Auckland, Fiji

## Monitor Settings

Tap the bottom tab (📖 150) → Tap 🗨️ (Setup menu) → 📺 Monitor settings

Set the options below.

### Shooting

Select whether the movie frame or framing grid is displayed on the shooting screen.

- **View/hide movie frm:** A frame is displayed before recording begins that represents the area that will be captured when recording movies.
- **View/hide framing grid:** A framing grid is displayed to help frame pictures. It is not displayed when recording movies.



- **Off** (default setting): The movie area and framing grid are not displayed.

### Playback

Set the shooting information displayed in the monitor during playback. See "Playback (Information Display)" (📖 12) for more information.

- **Show info:**



- **Auto info** (default setting): Current settings and operational guides are displayed as in **Show info** above. If no operations are performed for a few seconds, information is hidden. Information will be displayed again when the next operation is performed.

### Image review

- **On** (default setting): Image is automatically displayed in the monitor immediately after it is captured and the monitor display returns to shooting mode.
- **Off**: Image is not displayed after it is captured.

### Brightness

Choose from five settings for monitor brightness. The default setting is **3**.



## **DATE** Print Date (Imprinting Date and Time)

Tap the bottom tab (📖 150) → Tap **Y** (Setup menu) → **DATE** Print date

The shooting date and time can be imprinted on images and saved. Images with the date imprinted on them can be printed from printers that do not support printing of the date on images (📖 109).



### **DATE** Date

Date is imprinted on images.

### **DATE** Date and time

Date and time are imprinted on images.

### Off (default setting)

Date and time are not imprinted on images.

The print date setting can be confirmed in the monitor when shooting (📖 10). When **Off** is selected, no icon is displayed.



## **✓** Notes on Print Date

- Imprinted dates form a permanent part of image data and cannot be deleted. The date and time cannot be imprinted on images after they have been captured.
- The date is not imprinted in the following situations:
  - Images captured in **Panorama assist** scene mode
  - Movies
- Dates imprinted at an **Image mode** setting (📖 45) of **VGA 640×480** may be difficult to read. Choose an **Image mode** setting of **PC 1024×768** or larger when using date imprint.
- The date is saved using the format selected in the setup menu's **Time zone and date** item (📖 22, 152).

## **✍** Print Date and Print Order

When printing from DPOF-compatible printers that support the printing of shooting date and shooting information, the date and information can be printed without imprinting this information on them, using settings in the **Print order** option (📖 106).

## **Vibration Reduction**

Tap the bottom tab ( 150) → Tap  (Setup menu) →  Vibration reduction

Choose a vibration reduction option for shooting.

Vibration reduction reduces blur caused by slight hand movement known as camera shake, which commonly occurs when shooting with telephoto zoom applied or at slow shutter speeds. The effects of camera shake are reduced when recording movies, in addition to when taking still pictures.

Set **Vibration reduction** to **Off** when using a tripod to stabilize the camera during shooting.

 **On (default setting)**

The vibration reduction is enabled.

**OFF** Off

Vibration reduction is disabled.

The current vibration reduction setting can be confirmed in the camera monitor when shooting ( 10, 27). When **Off** is selected, no icon is displayed.

### **Notes on Vibration Reduction**

- Vibration reduction may take a few seconds to activate after the power is turned on, or the camera enters shooting mode from playback mode. Wait until the image of the monitor stabilizes before shooting.
- Due to characteristics of the vibration reduction function, images displayed in the camera's monitor immediately after shooting may be displayed blurry.
- Vibration reduction may be unable to completely eliminate the effects of camera shake in some situations.

## Motion Detection













Tap the bottom tab ( 150) → Tap  (Setup menu) →  Motion detection

Enable motion detection to reduce the effects of subject movement and camera shake when shooting still images.

### Auto (default setting)

When the camera detects subject movement or camera shake, the ISO sensitivity and shutter speed are automatically increased to reduce blurring.

However, motion detection does not function in the following situations.

- When the flash fires
- In  (auto) mode, when **Subject tracking** ( 50) is selected
- In  (auto) mode, when **ISO sensitivity** ( 55) is set to any setting other than **Auto**
- In  (auto) mode, when **Multi-shot 16** ( 56) is selected
- In the following scene modes:
  - **Sports** ( 65)
  - **Night portrait** ( 65)
  - **Dusk/dawn** ( 67)
  - **Night landscape** ( 67)
  - **Museum** ( 69)
  - **Fireworks show** ( 69)
  - **Backlighting** ( 70)

### OFF Off

Motion detection is disabled.

The current motion detection setting can be confirmed in the camera monitor when shooting ( 10, 27). The motion detection icon turns green when the camera detects camera shake and increases shutter speed. When **Off** is selected, no icon is displayed.

## Notes on Motion Detection

- Motion detection may be unable to completely eliminate the effects of subject movement and camera shake in some situations.
- Motion detection may not function if the subject exhibits significant movement or is too dark.
- The images captured using motion detection may be somewhat “grainy” in appearance.

## AF Assist

Tap the bottom tab ( 150) → Tap  (Setup menu) →  AF assist

Enable or disable AF-assist illumination, which assists autofocus operation when the subject is dimly lit.

### Auto (default setting)

AF-assist illumination will be used to assist the focus operation when the subject is dimly lit. The illuminator has a range of about 1.9 m (6 ft. 2 in.) at the maximum wide-angle position and about 1.1 m (3 ft. 7 in.) at the maximum telephoto position. Note that for some scene modes or focus areas, AF-assist illuminator may not light.

### Off



AF-assist illuminator does not light. The camera may be unable to focus under dim lighting.

## Digital Zoom

Tap the bottom tab ( 150) → Tap  (Setup menu) →  Digital zoom

Enable or disable digital zoom.

### On (default setting)

When the camera is zoomed in to the maximum optical zoom position, rotating the zoom control to **T** () triggers digital zoom ( 29).

### Off

Digital zoom will not be activated.

## Notes on Digital Zoom

- When digital zoom is in effect, the camera focuses at the center of the frame.
- Digital zoom cannot be used in the following situations.
  - When **Subject tracking** is selected for the touch shooting setting
  - When **Multi-shot 16** ( 56) is selected
  - When **Scene auto selector**, **Portrait**, **Night portrait** or **Pet portrait** scene mode is selected
  - When smart portrait mode is selected

## 🔊 Sound Settings

Tap the bottom tab (📖 150) → Tap 🛠️ (Setup menu) → 🔊 Sound settings

Adjust the following sound settings.

### Button sound

Select **On** (default setting) or **Off**.

When **On** is selected, a beep will sound once when operations are completed successfully, twice when the camera acquires focus on the subject, and three times when an error is detected. Start-up sound will also play when the camera is turned on.

### Shutter sound

Select **On** (default setting) or **Off**.

However, when some features such as continuous shooting or BSS (best shot selector) are enabled, when using the **Pet portrait** scene mode, or when recording movies, the shutter sound is not heard even if set to **On**.



## Auto Off

Tap the bottom tab ( 150) → Tap  (Setup menu) →  Auto off

When the camera is on and a period of time passes without any operations having been performed, the monitor will be turned off and the camera will enter standby mode ( 21) to save power.

In this option, set the time allowed to elapse before the camera enters standby mode. **30 s**, **1 min** (default setting), **5 min**, and **30 min** can be selected.

### When the Monitor Turns off for the Power Saving Function





- Power-on lamp blinks in standby mode.
- Camera turns off after three minutes passes in standby mode.
- To reactivate the monitor while the power on lamp is blinking, press any of the following buttons:
  - The power switch, shutter-release button,  button,  button, or  movie-record button

### Auto Off Settings

The time allowed to elapse before the camera enters standby mode is fixed in the following situations:

- When a setting screen, mode selection menu, or setup menu is displayed: three minutes
- During slide show playback: up to 30 minutes
- When the AC adapter EH-62F is connected: 30 minutes

## / **Format Memory/Format Card**

Tap the bottom tab ( 150) → Tap  (Setup menu) →  
 Format memory /  Format card

Use this option to format the internal memory or a memory card.

**Formatting the internal memory or memory cards permanently deletes all data. Data that has been deleted cannot be restored.** Be sure to transfer important images to a computer before formatting.

### **Formatting the Internal Memory**

To format the internal memory, remove the memory card from the camera.

The **Format memory** option is displayed in the setup menu.

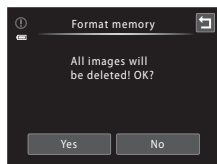

### **Formatting a Memory Card**

When a memory card is inserted in the camera, the **Format card** option is displayed in the setup menu.

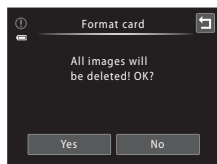

## **Formatting Internal Memory and Memory Cards**

- Album icon settings ( 93) are reset to their default settings (number icons) when the internal memory or memory card is formatted.
- Do not turn the camera off or open the battery-chamber/memory card slot cover during formatting.
- Be sure to use this camera to format memory cards previously used in other devices the first time they are inserted into the COOLPIX S6100.

## Language

Tap the bottom tab ( 150) → Tap  (Setup menu) →  Language

Choose one of 26 languages for display of camera menus and messages.

Čeština	Czech
Dansk	Danish
Deutsch	German
English	(default setting)
Español	Spanish
Ελληνικά	Greek
Français	French
Indonesia	Indonesian
Italiano	Italian
Magyar	Hungarian
Nederlands	Dutch
Norsk	Norwegian
Polski	Polish

Português	Portuguese
Русский	Russian
Română	Romanian
Suomi	Finnish
Svenska	Swedish
Türkçe	Turkish
Українська	Ukrainian
عربي	Arabic
简体中文	Simplified Chinese
繁體中文	Traditional Chinese
日本語	Japanese
한국	Korean
ภาษาไทย	Thai

## TV Settings

Tap the bottom tab ( 150) → Tap  (Setup menu) →  TV settings

Adjust settings for connection to a television.

### Video mode

Adjust video mode settings for connection to a television. Select from **NTSC** and **PAL**.

### HDMI

Choose an image resolution for HDMI output from **Auto** (default setting), **480p**, **720p**, or **1080i**. When **Auto** is selected, the option best suited to the high-definition TV to which the camera is connected is automatically selected from **480p**, **720p**, or **1080i**.

### HDMI device control



Select whether or not the camera can receive signals from a TV that supports the HDMI-CEC standard when it is connected to the TV via HDMI. When **On** (default setting) is selected, the TV's remote control can be used to control the camera during playback. See "Using a TV Remote Control (HDMI Device Control)" ( 136) for more information.

## HDMI and HDMI-CEC

HDMI (High-Definition Multimedia Interface) is a multimedia interface. HDMI-CEC (HDMI-Consumer Electronics Control) allows compatible devices to inter-operate.



## Charge by Computer

Tap the bottom tab ( 150) → Tap  (Setup menu) →  Charge by computer

Choose whether or not the battery inserted into the camera is charged when the camera is connected to a computer via the USB cable ( 142).

### Auto (default setting)

When the camera is connected to a computer that is running, the battery inserted into the camera is automatically charged using power supplied by the computer.

### Off

The battery inserted into the camera is not charged when the camera is connected to a computer.

## Notes on Connecting the Camera to a Printer

- The battery cannot be charged with connection to a printer, even if the printer complies with the PictBridge standard.
- When **Auto** is selected for **Charge by computer**, it may be impossible to print images with direct connection of the camera to some printers. If the PictBridge startup screen is not displayed in the monitor after the camera is connected to a printer and turned on, turn the camera off and disconnect the USB cable. Set **Charge by computer** to **Off** and reconnect the camera to the printer.

## Blink Warning

Tap the bottom tab ( 150) → Tap  (Setup menu) →  Blink warning

Specify whether or not the camera detects human subjects that have blinked using the face detection function ( 42) when shooting in the following modes.

-  (auto) mode ( 26).
- **Scene auto selector** ( 62), **Portrait** ( 64) or **Night portrait** ( 65) is selected for the scene mode.

### On

When the camera detects that one or more human subjects may have blinked in an image captured using the face detection function, the **Blink warning** screen is displayed in the monitor.

The face of the human subject that may have blinked when the shutter was released is framed by a yellow border. Should this occur, check the image and determine whether or not another image should be captured.

See "Operating the Blink Warning Screen" ( 167) for more information.

### Off (default setting)

Blink warning is disabled.

## Note on Blink Warning

The blink warning does not function at continuous settings of **Continuous**, **BSS**, or **Multi-shot 16**.

## Operating the Blink Warning Screen

When the blink warning screen shown on the right is displayed in the monitor, the operations described below are available.

If no operations are performed within a few seconds, the camera automatically returns to shooting mode.







Function	Icon	Description
Enlarge the detected face that blinked	<b>T</b> (Q)	Rotate the zoom control to <b>T</b> (Q). If the camera detects that more than one human subject blinked, tap  or  to switch display to another face.
Switch to full-frame playback	<b>W</b> (checkered flag)	Rotate the zoom control to <b>W</b> (checkered flag).
Delete the image		Tap .
Switch to shooting mode	<b>OK</b>	Tap <b>OK</b> . The shutter-release button can also be pressed to return to shooting mode.

## Reset All







Tap the bottom tab ( 150) → Tap  (Setup menu) →  Reset all

When **Reset** is selected, the camera's settings will be restored to their default values.





### Basic Shooting Functions

Option	Default value
Flash mode (  34)	Auto
Self-timer (  37)	Off
Macro mode (  39)	Off
Exposure compensation (  40)	0



### Auto Mode Shooting Mode

Option	Default value
Image mode (  45)	 4608x3456
Touch shooting (  47, 50, 52)	Touch shutter
ISO sensitivity (  55)	Auto
Continuous (  56)	Single
White balance (  57)	Auto

### Scene Mode

Option	Default value
Scene mode setting in the shooting-mode selection menu (  59)	Scene auto selector
Scene effect adjustment slider (  61)	Center
Continuous shooting in pet portrait mode (  71)	Continuous
Pet portrait auto release (  71)	On

### Smart Portrait Mode

Option	Default value
Skin softening (  79)	Normal
Blink proof (  79)	Off
Smile timer (  79)	On

**Playback Mode**

Option	Default value
Slide show (📖 103) Effects	Classic
Slide show (📖 103) Frame intvl	3 s
Slide show (📖 103) Background music	None
Slide show (📖 103) Volume	Medium

**Movie Recording**

Option	Default value
Movie options (📖 130)	When a memory card is inserted: 📺 HD 720p (1280x720)
Movie AF mode (📖 131)	Single AF
Wind noise reduction (📖 132)	Off

**Setup Menu**

Option	Default value
Welcome screen (📖 151)	None
Shooting (📖 155)	Off
Playback (📖 155)	Auto info
Image review (📖 156)	On
Brightness (📖 156)	3
Print date (📖 157)	Off
Vibration reduction (📖 158)	On
Motion detection (📖 159)	Auto
AF assist (📖 160)	Auto
Digital zoom (📖 160)	On
Button sound (📖 161)	On
Shutter sound (📖 161)	On
Auto off (📖 162)	1 min
HDMI (📖 164)	Auto
HDMI device control (📖 164)	On
Charge by computer (📖 165)	Auto
Blink warning (📖 166)	Off

**Others**

Option	Default value
Paper size (📖 145, 146)	Default

- Selecting **Reset** also clears the current file number (📖 178) from memory. Numbering will continue from the lowest number available. To reset file numbering to “0001”, delete all images saved in the internal memory or on the memory card (📖 33) before selecting **Reset**.
- The following menu settings will remain unaffected when menus are reset with **Reset all**.  
Shooting settings: Preset manual data (📖 58) acquired for **White balance**  
Setup menu: **Time zone and date** (📖 152), **Language** (📖 164), and **Video mode** under **TV settings** (📖 164)

## ☒ Copy (Copy Between Internal Memory and Memory Card)

Tap the bottom tab (📖 150) → Tap 📷 (Setup menu) → ☒ Copy

Copy images between the internal memory and a memory card.

### 1 Tap the desired option from the copy screen.

📷 → 📁: Copy images from internal memory to memory card.

📁 → 📷: Copy images from memory card to internal memory.

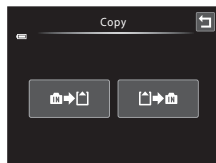

### 2 Tap the desired copy option.

**Selected images:** Copy images selected. Proceed to step 3.

**All images:** Copy all images. When a confirmation dialog is displayed, tap **Yes**. Images are copied. To return to the setup menu without copying, tap **No**.

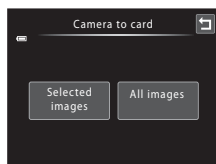

### 3 Tap the images to be copied.

When an image is selected, a check mark is displayed. To cancel the selection, tap the image again. A check mark is removed.

Tap 🔍 or rotate the zoom control to T (📷) to switch to full-frame playback and tap 🔍 or rotate the zoom control to W (📁) to switch back to 9-thumbnail display.



### 4 Tap OK.

When a confirmation dialog is displayed, tap **Yes**. Images are copied. To return to the setup menu without copying, tap **No**.

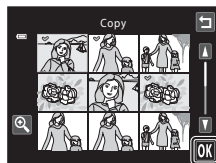

### **Notes on Copying Images**

- JPEG-, MOV-, and WAV-format files can be copied. Files saved in any other format cannot be copied.
- If voice memos (📖 111) are attached to images selected for copying, voice memos are copied with the images.
- Operation is not guaranteed with images captured with another make of camera or that have been modified on a computer.
- When copying images selected for a **Print order** (📖 106), the print order marking is not copied. However, rating (📖 101) and **Protect** (📖 104) settings are copied with images.
- Images or movies copied from the internal memory to a memory card, or vice versa, cannot be displayed in auto sort mode (📖 95).
- When images added to albums (📖 88) are copied, the copies are not automatically added to the same albums as the original images.

### **“Memory contains no images.” Message**

If there are no images saved on a memory card inserted in the camera when playback mode is applied, the message **Memory contains no images.** will be displayed. Perform the followings to copy images in the internal memory to a memory card.

1. Tap the bottom tab to display the setting controls and tap .
2. Tap **Copy** in the displayed setup menu.

### **More Information**

See “File and Folder Names” (📖 178) for more information.

## **Ver. Firmware Version**

Tap the bottom tab (📖 150) → Tap  (Setup menu) → **Ver.** Firmware version

View the current camera firmware version.





# Maximizing Camera Life and Performance

To ensure continued enjoyment of this Nikon product, observe the following precautions when using or storing the device.

### **Keep dry**

The device will be damaged if immersed in water or subjected to high humidity.

### **Do not drop**

The product may malfunction if subjected to strong shock or vibration.

### **Handle the lens, and all moving parts with care**

Do not apply force to the lens, lens cover, monitor, memory card slot or battery chamber. These parts are easily damaged. Applying force to the lens cover could result in camera malfunction or damage to the lens. Should the monitor break, care should be taken to avoid injury caused by broken glass and to prevent the liquid crystal from the display touching the skin or entering the eyes or mouth.

### **Do not point the lens at strong light sources for extended periods**

Avoid pointing the lens at the sun or other strong light sources for extended periods when using or storing the camera. Intense light may cause deterioration of the CCD image sensor, producing a white blur effect in photographs.

### **Keep away from strong magnetic fields**

Do not use or store this device in the vicinity of equipment that generates strong electromagnetic radiation or magnetic fields. Strong static charge or the magnetic fields produced by equipment such as radio transmitters could interfere with the monitor, damage data saved on the memory card, or affect the product's internal circuitry.

### **Avoid sudden changes in temperature**

Sudden changes in temperature, such as when entering or leaving a heated building on a cold day, can cause condensation to form inside the device. To prevent condensation, place the device in a carrying case or a plastic bag before exposing it to sudden changes in temperature.

### **Turn the product off before removing or disconnecting the power source**

Do not remove the battery while the product is on, or while images are being saved or deleted. Forcibly cutting power in these circumstances could result in loss of data or in damage to product memory or internal circuitry.

### **The Battery**

- Check the battery level before using the camera and replace or charge the battery if necessary. Do not continue charging once the battery is fully charged as this will result in reduced battery performance. Whenever possible, carry a fully charged spare battery when taking pictures on important occasions.
- Do not use the battery at ambient temperatures below 0 °C (32 °F) or above 40 °C (104 °F). Failure to observe this precaution could damage the battery or impair its performance.
- Charge the battery indoors with an ambient temperature of 5 °C to 35 °C (41 °F to 95 °F) before use.
- When charging the COOLPIX S6100 using the Charging AC adapter EH-69P or a computer, the charge capacity may decrease at ambient temperatures 45 °C to 60 °C (113 °F to 140 °F). The battery is not charged at ambient temperatures below 0 °C (32 °F) or above 60 °C (140 °F).
- Note that the battery may become hot during use; wait for the battery to cool before charging. Failure to observe these precautions could damage the battery, impair its performance, or prevent it from charging normally.
- On cold days, the capacity of batteries tends to decrease. Be sure that the battery is fully charged before heading outside to take pictures in cold weather. Keep spare batteries in a warm place and exchange as necessary. Once warmed, a cold battery may recover some of its charge.
- Dirt on the battery terminals can prevent the camera from functioning. Should the battery terminals become dirty, wipe them off with a clean, dry cloth before use.
- If the battery will not be used for some time, insert it in the camera and run it flat before removing it for storage. The battery should be stored in a cool location with an ambient temperature of 15 to 25 °C (59 to 77 °F). Do not store the battery in hot or extremely cold locations.
- Always remove the battery from the camera or optional battery charger when it is not being used. When inserted, minute amounts of current are drawn from the battery even when not in use. This may result in excessive draining of the battery and complete loss of function. Turning the camera on or off while the battery is exhausted can result in reduced battery life.
- Recharge the battery at least once every six months and completely exhaust it before returning it to storage.
- After removing the battery from the camera or battery charger, replace the supplied terminal cover and store in a cool place.
- A marked drop in the time a fully-charged battery retains its charge, when used at room temperature, indicates that the battery needs to be replaced. Purchase a new EN-EL12 battery.
- Replace the battery when it no longer holds a charge. Used batteries are a valuable resource. Please recycle used batteries in accordance with local regulations.

## Cleaning

Lens	Avoid touching the lens with your fingers. Remove dust or lint with a blower (typically a small device with a rubber bulb attached to one end that is pumped to produce a stream of air out the other end). To remove fingerprints or other stains that cannot be removed with a blower, wipe the lens with a soft cloth, using a spiral motion that starts at the center of them and working toward the edges. If this fails, clean them using a cloth lightly dampened with commercial lens cleaner.
Monitor	Remove dust or lint with a blower. To remove fingerprints and other stains, clean the monitor with a soft, dry cloth, being careful not to apply pressure.
Body	Use a blower to remove dust, dirt or sand, then wipe gently with a soft, dry cloth. After using the camera at the beach or other sandy or dusty environment, wipe off any sand, dust, or salt with a dry cloth lightly dampened with fresh water and dry thoroughly. <b>Note that foreign matter inside the camera could cause damage not covered by the warranty.</b>

Do not use alcohol, thinner, or other volatile chemicals.

## Storage

Turn the camera off when not in use. Be sure that the power-on lamp is off before putting the camera away. Remove the battery if the camera will not be used for an extended period. Do not store the camera with naphtha or camphor moth balls, or in any of the following locations:

- Next to equipment that produces strong electromagnetic fields, such as televisions or radios
- Exposed to temperatures below  $-10^{\circ}\text{C}$  ( $14^{\circ}\text{F}$ ) or above  $50^{\circ}\text{C}$  ( $122^{\circ}\text{F}$ )
- Places that are poorly ventilated or subject to humidity of over 60%

To prevent mold or mildew, take the camera out of storage at least once a month. Turn the camera on and release the shutter a few times before putting the camera away again.

### Notes on the Monitor

- The monitor may contain a few pixels that are always lit or that do not light. This is a characteristic common to all TFT LCD displays, and does not indicate a malfunction. Images saved using the product will not be affected.
- White or colored streaks may be visible when bright subjects are framed in the monitor. This phenomenon, known as “smear,” occurs when extremely bright light strikes the image sensor; it is characteristic of image sensors and does not indicate a malfunction. Smear may also take the form of partial discoloration in the monitor during shooting. It does not appear in images saved with the camera except in the cases of movies and of images saved with **Multi-shot 16** selected for **Continuous**. When shooting in these modes, we recommend that you avoid bright subjects such as the sun, reflected sunlight, and electric lights.
- Images in the monitor may be difficult to see under bright lighting.
- The monitor is lit by an LED backlight. Should the monitor begin to dim or flicker, contact your Nikon-authorized service representative.

## Optional Accessories

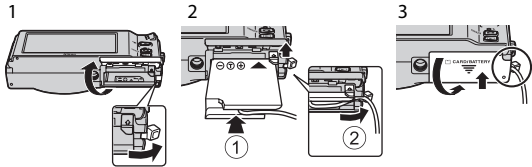
Rechargeable battery	Rechargeable Li-ion Battery EN-EL12 <sup>1</sup>
Charging AC adapter	Charging AC Adapter EH-69P <sup>1, 2</sup>
Battery charger	Battery Charger MH-65
AC adapter	<p>AC Adapter EH-62F (connect as shown)</p>  <p>Be sure that the power connector cord has been properly aligned in power connector and battery chamber grooves before closing the battery-chamber/memory card slot cover. If part of the cord runs out of the grooves, the cover or cord may be damaged when the cover is closed.</p>
USB cable	USB Cable UC-E6 <sup>1</sup>
Audio/video cable	Audio Video Cable EG-CP16 <sup>1</sup>

<sup>1</sup> Supplied with camera at time of purchase (see page 3 of the Quick Start Guide).



<sup>2</sup> When using in other countries, use a plug adapter (commercially available) as necessary. For more information about plug adapters, consult your travel agency.

## Approved Memory Cards

The following Secure Digital (SD) memory cards have been tested and approved for use in this camera.

- Memory cards with an SD Speed Class rating of 6 or faster are recommended for recording movies. Movie recording may stop unexpectedly when memory cards with a lower Speed Class rating are used.

	SD memory card	SDHC memory card <sup>2</sup>	SDXC memory card <sup>3</sup>
SanDisk	2 GB <sup>1</sup>	4 GB, 8 GB, 16 GB, 32 GB	64 GB
TOSHIBA	2 GB <sup>1</sup>	4 GB, 8 GB, 16 GB, 32 GB	64 GB
Panasonic	2 GB <sup>1</sup>	4 GB, 8 GB, 12 GB, 16 GB, 24 GB, 32 GB	48 GB, 64 GB
Lexar	2 GB <sup>1</sup>	4 GB, 8 GB, 16 GB, 32 GB	–

- If the memory card is used with a card reader or similar device, be sure that the device supports an SD memory card of 2 GB or more.
- SDHC compliant. If the memory card is used with a card reader or similar device, be sure that the device is compliant with the SDHC standard. 
- SDXC compliant. If the memory card is used with a card reader or similar device, be sure that the device is compliant with the SDXC standard. 

Contact the manufacturer for details on the above cards.

## File and Folder Names



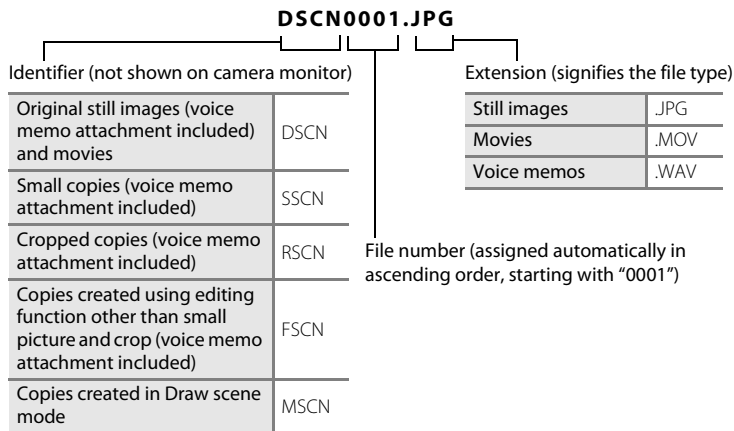





Images, movies, or voice memos are assigned file names as follows.





- Files are saved in folders named with a folder number followed by a five-character identifier: "P\_" plus a three-digit sequence number for images captured using **Panorama assist** scene mode (e.g. "101P\_001"; 📖 74) and "NIKON" for all other images (e.g. "100NIKON"). When the number of files within a folder reaches 9999, a new folder will be created. File numbers will be assigned automatically starting with "0001."
- Voice memo file names have the same identifier and file number as the image to which the voice memo is attached.
- Files copied using **Copy>Selected images** are copied to the current folder, where they are assigned new file numbers in ascending order starting from the largest file number in memory. **Copy>All images** copies all folders from the source medium; file names do not change but new folder numbers are assigned in ascending order, starting from the largest folder number on the destination medium (📖 171).
- A single folder can hold up to 200 images; if the current folder already contains 200 images, a new folder, named by adding one to the current folder name, will be created the next time an image is captured. If the current folder is numbered 999 and contains 200 images, or an image is numbered 9999, no further images can be captured until the internal memory or memory card is formatted (📖 163), or a new memory card is inserted.

## Error Messages









The following table lists the error messages and other warnings displayed in the monitor, as well as the solutions for dealing with them.

Display	Description	Solution	
 (blinks)	Clock not set.	Set date and time.	152
 Battery exhausted.	Battery exhausted.	Charge or replace the battery.	16, 18
 Battery temperature high	Battery temperature is high.	Turn off camera, and allow battery to cool down before resuming use. After five seconds, this message will disappear, the monitor will turn off, and the power-on lamp will blink rapidly. After the lamps blink for three minutes, the camera will turn off automatically. Pressing the power switch also turns off the camera.	21
 ● (● blinks red)	Camera cannot focus.	<ul style="list-style-type: none"> <li>• Refocus.</li> <li>• Focus on another subject positioned at the same distance from the camera as the intended subject.</li> </ul>	30, 31 54
 Please wait for the camera to finish recording.	Camera cannot perform other operations until saving is complete.	Wait until message clears from display automatically when saving is complete.	–
 Memory card is write protected.	Write-protect switch is in “lock” position.	Slide write-protect switch to “write” position.	25
 This card cannot be used.	Error accessing memory card.	<ul style="list-style-type: none"> <li>• Use approved card.</li> <li>• Check that connectors are clean.</li> <li>• Confirm that memory card is correctly inserted.</li> </ul>	177 24
 This card cannot be read.			24











## Error Messages





Display	Description	Solution	
<p><b>!</b> Card is not formatted. Format card? Yes No</p>	Memory card has not been formatted for use in COOLPIX S6100.	Formatting deletes all data saved on the memory card. Be sure to tap <b>No</b> and make copies of any images which need to be kept before formatting the memory card. Tap <b>Yes</b> to format the memory card.	25
<p><b>i</b> Out of memory.</p>	Memory card is full.	<ul style="list-style-type: none"> <li>• Choose smaller image size.</li> <li>• Delete images.</li> <li>• Insert new memory card.</li> <li>• Remove memory card and use internal memory.</li> </ul>	45 33 24 24
<p><b>!</b> Image cannot be saved.</p>	Error occurred while saving image.	Format internal memory or memory card.	163
	Camera has run out of file numbers.	Insert new memory card, or format internal memory or memory card.	178
	Image cannot be used for welcome screen.	<p>The following images cannot be registered as welcome screen.</p> <ul style="list-style-type: none"> <li>• Images captured at an <b>Image mode</b> setting of  <b>4608x2592</b></li> <li>• Images reduced to 320 x 240 size or smaller with cropping or small picture editing</li> </ul>	151
	Insufficient space to save a copy.	Delete images from destination.	33
<p><b>!</b> Album is full. No further pictures can be added.</p>	200 images have already been added to album.	<ul style="list-style-type: none"> <li>• Remove some images from album.</li> <li>• Add to other albums.</li> </ul>	91 88
<p><b>i</b> A blink was detected in the picture just taken.</p>	One or more portrait subjects may have blinked when the image was captured.	Check the image in playback mode.	79, 82



Display	Description	Solution	
 Sound file cannot be saved.	A voice memo cannot be attached to this file.	<ul style="list-style-type: none"> <li>Voice memos cannot be attached to movies.</li> <li>Select an image captured with COOLPIX S6100.</li> </ul>	– 112
 Image cannot be modified.	Cannot edit selected image.	<ul style="list-style-type: none"> <li>Select images that support editing function.</li> <li>Movies cannot be edited.</li> </ul>	113 –
 Cannot record movie.	Time out error while recording movie.	Choose memory card with faster write speed.	129, 177
 Memory contains no images.	No images in the internal memory or memory card.	<ul style="list-style-type: none"> <li>Remove the memory card from the camera to play back images saved in the camera's internal memory.</li> <li>To copy image from internal memory to memory card, display the setup menu and select <b>Copy</b>.</li> </ul>	24 171
	The image has not been added to album.	<ul style="list-style-type: none"> <li>Add the image to album.</li> <li>Choose the album to which image was added.</li> </ul>	88 90
	No images are contained in the category selected in auto sort mode.	Select the category containing the sorted images.	96
 File contains no image data.	File not created with this camera.	File cannot be viewed on this camera. View file using a computer or the device used to create or edit this file.	–
 This file cannot be played back.			
 All images are hidden.	No images are available for a slide show.	–	102
 This image cannot be deleted.	Image is protected.	Disable protection.	104

## Error Messages

Display	Description	Solution	
 Travel destination is in the current time zone.	Destination in same time zone as home.	–	154
 Rating maximum reached. No further pictures can be rated.	999 images have already been rated.	Cancel the rating setting of them.	101
 No images with this rating found.	There are no images with the selected rating.	<ul style="list-style-type: none"> <li>• Apply the rating to images.</li> <li>• Select a rating that has been applied to images.</li> </ul>	101 101
 Movies can not be rated.	Tried to rate a movie.	Ratings cannot be applied to movies. Select a still image.	101
Lens error 	Lens error.	Turn camera off and then on again. If error persists, contact retailer or Nikon-authorized service representative.	21, 26
 Communications error	USB cable disconnected during data transfer to printer.	Turn camera off and reconnect cable.	144
System error 	Error has occurred in camera's internal circuitry.	Turn camera off, remove and reinsert battery, and turn camera on. If error persists, contact retailer or Nikon-authorized service representative.	17
 Printer error: check printer status.	Printer error.	Check printer. After solving the problem, tap <b>Resume</b> to resume printing.*	–
 Printer error: check paper	Specified size of paper is not loaded in printer.	Load the specified paper, tap <b>Resume</b> to resume printing.*	–
 Printer error: paper jam	Paper has jammed in printer.	Eject the jammed paper, tap <b>Resume</b> to resume printing.*	–

Display	Description	Solution	
 Printer error: out of paper	No paper is loaded in printer.	Load the specified paper, tap <b>Resume</b> to resume printing.*	–
 Printer error: check ink	Ink error.	Check ink, tap <b>Resume</b> to resume printing.*	–
 Printer error: out of ink	Running out of ink or ink cartridge is empty.	Replace ink cartridge, tap <b>Resume</b> to resume printing.*	–
 Printer error: file corrupt	An error caused by the image file has occurred.	Tap <b>Cancel</b> to cancel printing.	–





\* See the documentation provided with your printer for further guidance and information.

## Troubleshooting

If the camera fails to function as expected, check the list of common problems below before consulting your retailer or Nikon-authorized service representative.

### Display, Settings and Power Supply

Problem	Cause/Solution	
The battery inserted in the camera cannot be charged.	• Confirm all connections.	18
	• <b>Off</b> is selected for <b>Charge by computer</b> in the setup menu.	165
	• When charging by connecting the camera to a computer, battery charging stops when the camera is turned off.	142
	• When charging by connecting the camera to a computer, battery charging stops when the computer is suspended (sleeping), and the camera may turn off.	142
	• Depending upon computer specifications, settings, and status, charging the battery inserted in the camera may not be possible via computer connection.	–
Camera cannot be turned on.	• Battery is exhausted.	26
	• The camera cannot be turned on while connected to an electrical outlet via the Charging AC Adapter.	18
Camera turns off without warning.	• Battery is exhausted.	26
	• Camera has turned off automatically to save power.	162
	• The camera and battery may not work properly at low temperatures.	174
	• The camera turns off if the Charging AC Adapter is connected while the camera is on.	18
	• The camera turns off if the USB cable connecting it to a computer or printer is disconnected. Reconnect the USB cable.	138, 140, 144
	• Inside of the camera has become hot. Leave the camera off until the inside of the camera has cooled, and then try turning it on again.	–

Problem	Cause/Solution	
Monitor is blank.	<ul style="list-style-type: none"> <li>• Camera is off.</li> <li>• Standby mode for saving power: press the power switch, the shutter-release button,  button,  button, or  button.</li> </ul>	21 21, 162
	<ul style="list-style-type: none"> <li>• When flash lamp blinks, wait until flash has charged.</li> </ul>	35
	<ul style="list-style-type: none"> <li>• Camera and computer are connected via USB cable.</li> </ul>	138
	<ul style="list-style-type: none"> <li>• Camera and TV are connected via audio/video cable or HDMI cable.</li> </ul>	134
	Date and time of recording are not correct.	<ul style="list-style-type: none"> <li>• If camera clock has not been set, "Date not set" indicator blinks during shooting and movie recording. Images and movies saved before clock is set are dated "00/00/0000 00:00" or "01/01/2011 00:00" respectively. Set the correct time and date using the <b>Date and time</b> setting in <b>Time zone and date</b> option in the setup menu.</li> </ul>
<ul style="list-style-type: none"> <li>• Check camera clock regularly against more accurate timepieces and reset as required.</li> </ul>		152
Monitor is hard to read.	<ul style="list-style-type: none"> <li>• Adjust monitor brightness.</li> <li>• Monitor is dirty. Clean monitor.</li> </ul>	155 175
No indicators displayed in monitor.	<b>Playback</b> is set to <b>Auto info</b> for <b>Monitor settings</b> in the setup menu.	155
<b>Print date</b> not available.	Set the correct time and date using the <b>Date and time</b> setting in <b>Time zone and date</b> option in the setup menu.	22, 152
Date not appearing on images even when <b>Print date</b> is enabled.	<ul style="list-style-type: none"> <li>• Another function that restricts the <b>Print date</b> option is enabled.</li> </ul>	80
	<ul style="list-style-type: none"> <li>• The current shooting mode is one that does not support <b>Print date</b>.</li> </ul>	157
Screen for setting date and time is displayed when camera is turned on. Camera settings reset.	Clock battery is exhausted; all settings were restored to their default values.	153



Problem	Cause/Solution	
Monitor turns off, and the power-on lamp blinks rapidly.	Battery temperature is high. Turn off camera and allow battery to cool down before resuming use. After the lamp blinks for three minutes, the camera will turn off automatically. Pressing the power switch also turns off the camera.	21
Camera becomes hot.	The camera may become hot when shooting movies for an extended period of time or when the camera is used in a hot area; this is not a malfunction.	–







### Electronically Controlled Cameras

In extremely rare instances, unusual characters may appear in the monitor and the camera may stop functioning. In most cases, this phenomenon is caused by a strong external static charge. Turn the camera off, remove and replace the battery, then turn the camera on again. In the event of continued malfunction, contact your retailer or Nikon-authorized service representative. Note that disconnecting the power source as described above may result in the loss of any data not saved to internal memory or the memory card at the time the problem occurred. Data already saved will not be affected.



### Shooting

Problem	Cause/Solution	
Cannot switch to shooting mode.	Disconnect HDMI cable or USB cable.	134, 138, 144
No image captured when shutter-release button is pressed.	• When camera is in playback mode, or setting items or setup menu are displayed, press the shutter-release button.	32
	• Battery is exhausted.	26
	• When flash lamp blinks, flash is charging.	35



Problem	Cause/Solution	
Camera cannot focus.	<ul style="list-style-type: none"> <li>• Subject is too close. Try shooting using macro mode, or the <b>Scene auto selector</b> or <b>Close-up</b> scene mode.</li> <li>• The intended subject is one with which autofocus does not perform well.</li> <li>• Set <b>AF assist</b> in the setup menu to <b>Auto</b>.</li> <li>• Turn camera off and then on again.</li> </ul>	39, 62, 68  31  160 21
Images are blurred.	<ul style="list-style-type: none"> <li>• Use flash.</li> <li>• Increase the ISO sensitivity value.</li> <li>• Enable vibration reduction or motion detection.</li> <li>• Use <b>BSS</b> (best shot selector).</li> <li>• Use tripod and self-timer.</li> </ul>	34 55 158, 159 56 37
Streaks of light or partial discoloration are visible in the monitor.	Smear occurs when extremely bright light strikes the image sensor. When shooting with <b>Continuous</b> set to <b>Multi-shot 16</b> and when recording movies, avoiding bright objects, such as the sun, reflections of the sun, and electric lights is recommended.	175
Bright specks appear in images captured with flash.	Flash is reflecting off particles in air. Set the flash mode setting to  (off).	35
Flash does not fire.	<ul style="list-style-type: none"> <li>• The flash mode is set to  (off).</li> <li>• Scene mode with which the flash does not function is selected.</li> <li>• <b>On</b> is selected for <b>Blink proof</b> in smart portrait mode.</li> <li>• Another function that restricts flash is enabled.</li> </ul>	34 60 79 80
Digital zoom cannot be used.	<ul style="list-style-type: none"> <li>• <b>Digital zoom</b> is set to <b>Off</b> in the setup menu.</li> <li>• Digital zoom is not available in the following situations.                             <ul style="list-style-type: none"> <li>- When <b>Subject tracking</b> is selected for the touch shooting setting.</li> <li>- When <b>Scene auto selector, Portrait, Night portrait</b> or <b>Pet portrait</b> scene mode is selected.</li> <li>- When shooting in smart portrait mode</li> <li>- When <b>Continuous</b> is set to <b>Multi-shot 16</b>.</li> </ul> </li> </ul>	160  50 62, 64, 65, 71 76 56
<b>Image mode</b> not available.	Another function that restricts the <b>Image mode</b> option is enabled.	80

Problem	Cause/Solution	
No sound when shutter is released.	<b>Off</b> is selected for <b>Sound settings&gt;Shutter sound</b> in setup menu. No sound is heard with some shooting modes and settings, even when <b>On</b> is selected.	161
AF-assist illuminator does not light.	<b>Off</b> is selected for the <b>AF assist</b> option in the setup menu. AF-assist illuminator may not light depending on the position of the focus area or the current scene mode, even when <b>Auto</b> is selected.	64-71, 160
Images appear smeared.	Lens is dirty. Clean lens.	175
Colors are unnatural.	White balance does not match light source.	57
Randomly spaced bright pixels ("noise") appear in image.	Shutter speed too slow or ISO sensitivity is high as the subject is dark. Noise can be reduced by: <ul style="list-style-type: none"> <li>• Using flash.</li> <li>• Specifying a lower ISO sensitivity setting.</li> </ul>	34 55
Images are too dark (underexposed).	<ul style="list-style-type: none"> <li>• The flash mode is set to  (off)</li> <li>• Flash window is blocked.</li> <li>• Subject is beyond flash range.</li> <li>• Adjust exposure compensation.</li> <li>• Increase ISO sensitivity.</li> <li>• Subject is backlit. Select <b>Backlighting</b> scene mode or set the flash mode setting to  (fill flash).</li> </ul>	34 28 34 40 55 34, 70
Images are too bright (overexposed).	Adjust exposure compensation.	40
Unexpected results when flash set to  (auto with red-eye reduction).	When taking pictures with  (auto with red-eye reduction) or fill flash with slow sync and red-eye reduction in <b>Night portrait</b> scene mode, In-Camera Red-Eye Fix may be applied to areas not affected by red-eye. Use any scene mode other than <b>Night portrait</b> , and change the flash mode to any setting other than  (auto with red-eye reduction) and try shooting again.	34, 65
Skin tones are not softened.	<ul style="list-style-type: none"> <li>• Under some shooting conditions, facial skin tones may not be softened.</li> <li>• Select  (skin softening) for <b>Glamour retouch</b> in the retouch menu for images containing four or more faces.</li> </ul>	77 124



Problem	Cause/Solution	
Saving images takes time.	It may take more time to save images in the following situations.	35
	<ul style="list-style-type: none"> <li>When the noise reduction function is in operation</li> <li>When flash mode is set to  (auto with red-eye reduction)</li> </ul>	36
	<ul style="list-style-type: none"> <li>When the skin softening function is applied while shooting</li> </ul>	64, 65, 79

## Playback



Problem	Cause/Solution	
File cannot be played back.	<ul style="list-style-type: none"> <li>File or folder was overwritten or renamed by computer or other make of camera.</li> <li>The COOLPIX S6100 is not able to playback movies recorded with another make or model of digital camera.</li> </ul>	– 133
Cannot zoom in on image.	<ul style="list-style-type: none"> <li>Playback zoom cannot be used with movies, small pictures, or images that have been cropped to a size of 320 × 240 or smaller.</li> <li>The COOLPIX S6100 is not able to zoom in on images captured with another make or model of digital camera.</li> </ul>	–
Cannot record or play back voice memos.	<ul style="list-style-type: none"> <li>Voice memos cannot be attached to movies.</li> <li>Voice memos cannot be attached to images captured with other cameras. Voice memos attached to images using another camera cannot be played back on this camera.</li> </ul>	133 111
Cannot edit images.	<ul style="list-style-type: none"> <li>These options cannot be used with movies.</li> <li>These options cannot be used with images captured at an <b>Image mode</b> setting of  <b>4608×2592</b>.</li> <li>Select images that support editing functions.</li> <li>Camera is unable to edit images captured with other cameras.</li> </ul>	133 45 113 113

Problem	Cause/Solution	
Images not displayed on television.	<ul style="list-style-type: none"> <li>• <b>Video mode</b> or <b>HDMI</b> is not correctly set in the <b>TV settings</b> setup menu.</li> <li>• Both an HDMI cable and an audio/video cable, or both an HDMI cable and a USB cable are connected.</li> <li>• Memory card contains no images. Replace the memory card. Remove the memory card to play back images from the internal memory.</li> <li>• TV display is turned off and images are displayed in the camera monitor.</li> </ul>	164 134, 138 24 136
Album icon restored to default settings, or images added to album not displayed in favorite pictures mode.	Data on the memory card may not be played back correctly if overwritten by a computer.	–
The saved images are not displayed in auto sort mode.	<ul style="list-style-type: none"> <li>• The desired image was sorted to a category other than the category currently displayed.</li> <li>• Images saved by a camera other than the COOLPIX S6100 and images copied using the <b>Copy</b> option cannot be displayed in auto sort mode.</li> <li>• Images saved in the internal memory or on the memory card may not be played back correctly if overwritten by a computer.</li> <li>• Up to 999 images and movies in total can be added to each category. If the desired category already contains 999 images or movies in total, new images or movies cannot be added.</li> </ul>	95 171 – 96
Nikon Transfer 2 does not start when camera is connected.	<ul style="list-style-type: none"> <li>• Camera is off.</li> <li>• Battery is exhausted.</li> <li>• USB cable is not correctly connected.</li> <li>• Camera is not recognized by the computer.</li> <li>• Confirm system requirements.</li> <li>• Computer is not set to start Nikon Transfer 2 automatically. For more information on Nikon Transfer 2, refer to help information contained in ViewNX 2.</li> </ul>	21 26 138 – 137 141

Problem	Cause/Solution	
The PictBridge startup screen is not displayed when the camera is connected to a printer.	With some PictBridge-compatible printers, the PictBridge startup screen may not be displayed and it may be impossible to print images when <b>Auto</b> is selected for the <b>Charge by computer</b> option in the setup menu. Set the <b>Charge by computer</b> option to <b>Off</b> and reconnect the camera to the printer.	165
Images to be printed are not displayed.	<ul style="list-style-type: none"> <li>• Memory card contains no images. Replace the memory card.</li> <li>• Remove the memory card to print images from the internal memory.</li> </ul>	24 24
Cannot select paper size with camera.	Paper size cannot be selected from the camera in the following situations, even when printing from a PictBridge-compatible printer: <ul style="list-style-type: none"> <li>• The printer does not support the paper sizes specified by the camera.</li> <li>• The printer automatically selects the paper size.</li> </ul>	145, 146 –

# Specifications

## Nikon COOLPIX S6100 Digital Camera

Type	Compact digital camera
Effective pixels	16.0 million
Image sensor	<sup>1</sup> /2.3-in. type CCD; total pixels: approx. 16.44 million
Lens	7x optical zoom, NIKKOR lens
Focal length	5.0-35.0mm (angle of view equivalent to that of 28-196 mm lens in 35mm [135] format)
f/-number	f/3.7-5.6
Construction	9 elements in 7 groups
Digital zoom	Up to 4x (angle of view equivalent to that of approx. 784 mm lens in 35mm [135] format)
Vibration reduction	Lens-shift
Autofocus (AF)	Contrast-detect AF
Focus range (from lens)	<ul style="list-style-type: none"><li>• Approx. 50 cm (1 ft. 8 in.) to ∞ (W); approx. 1.1 m (3 ft. 8 in.) to ∞ (T)</li><li>• Macro mode: Approx. 3 cm (1.2 in.) (zoom position on the wide-angle side from the  icon where the  icon glows green) to ∞</li></ul>
Focus-area selection	Face priority, auto (9-area automatic selection), center, manual (focus area can be selected using the touch panel), subject tracking
Monitor	7.5 cm (3-in.), approx. 460k-dot, TFT LCD (touch panel) with anti-reflection coating and 5-level brightness adjustment
Frame coverage (shooting mode)	Approx. 97% horizontal and 97% vertical (compared to actual picture)
Frame coverage (playback mode)	Approx. 100% horizontal and 100% vertical (compared to actual picture)
Storage	
Media	<ul style="list-style-type: none"><li>• Internal memory (approx. 20 MB)</li><li>• SD/SDHC/SDXC memory card</li></ul>
File system	DCF, Exif 2.3, and DPOF compliant
File formats	Still pictures: JPEG Sound files (Voice Memo): WAV Movies: MOV (Video: H.264/MPEG-4 AVC, Audio: AAC stereo)
Image size (pixels)	<ul style="list-style-type: none"><li>• 16M (High image quality) [4608 × 3456 ★]</li><li>• 16M [4608 × 3456]</li><li>• 8M [3264 × 2448]</li><li>• 5M [2592 × 1944]</li><li>• 3M [2048 × 1536]</li><li>• PC [1024 × 768]</li><li>• VGA [640 × 480]</li><li>• 16:9 [4608 × 2592]</li></ul>

ISO sensitivity (Standard output sensitivity)	<ul style="list-style-type: none"> <li>• ISO 80, 100, 200, 400, 800, 1600, 3200</li> <li>• Auto (auto gain from ISO 80 to 1600)</li> <li>• Fixed range auto (ISO 80 to 400, 80 to 800)</li> </ul>
Exposure	
Metering	256-segment matrix, center-weighted (digital zoom less than 2x), spot (digital zoom 2x or more)
Exposure control	Programmed auto exposure with motion detection and exposure compensation (-2.0 to +2.0 EV in steps of 1/3 EV)
Shutter	Mechanical and charge-coupled electronic shutter
Speed	1/2000-1 s 4 s (when scene mode is set to <b>Fireworks show</b> )
Aperture	Electronically-controlled ND filter (-3 AV) selection
Range	2 steps (f/3.7 and f/10.4 [W])
Self-timer	Can be selected from 10 and 2 second duration
Flash	
Range (approx.) (ISO sensitivity: <b>Auto</b> )	[W]: 0.5 to 4.5 m (1 ft. 8 in. to 14 ft.) [T]: 1.1 to 2.4 m (3 ft. 8 in. to 7 ft. 10 in.)
Flash control	TTL auto flash with monitor preflashes
Interface	Hi-Speed USB
Data transfer protocol	MTP, PTP
Video output	Can be selected from NTSC and PAL
HDMI output	Can be selected from Auto, 480p, 720p, and 1080i
I/O terminal	Audio video output/digital I/O (USB), HDMI mini connector (Type C) (HDMI output)
Supported languages	Arabic, Chinese (Simplified and Traditional), Czech, Danish, Dutch, English, Finnish, French, Greek, German, Hungarian, Indonesian, Italian, Japanese, Korean, Polish, Portuguese, Norwegian, Romanian, Russian, Spanish, Swedish, Thai, Turkish, Ukrainian
Power sources	One EN-EL12 Rechargeable Li-ion Battery (supplied) AC Adapter EH-62F (available separately)
Charging time	Approx. 3 hours and 20 minutes (when using Charging AC Adapter EH-69P and when no charge remains)
Battery life (EN-EL12)	Still pictures*: Approx. 210 shots Movies: Approx. 1 h 35 min ( <b>HD 720p (1280x720)</b> )
Tripod socket	1/4 (ISO 1222)
Dimensions (W x H x D)	Approx. 97.9 x 58.0 x 26.6 mm (3.9 x 2.3 x 1.1 in.) (excluding projections)
Weight	Approx. 175 g (6.2 oz.) (with battery and SD memory card)

## Specifications

### Operating environment

**Temperature** 0°C to 40°C (32°F to 104°F)

**Humidity** Less than 85% (no condensation)

- Unless otherwise stated, all figures are for a camera with a fully-charged Rechargeable Li-ion Battery EN-EL12 operated at an ambient temperature of 25 °C (77 °F).
- \* Based on Camera and Imaging Products Association (CIPA) standards for measuring the life of camera batteries. Measured at 23 (±2) °C (73 (±4) °F); zoom adjusted with each shot, flash fired with every other shot, image mode set to  **4608x3456**. Battery life may vary depending on shooting interval and length of time menus and images are displayed.

**Rechargeable Li-ion Battery EN-EL12**

Type	Rechargeable lithium-ion battery
Rated capacity	DC 3.7 V, 1050 mAh
Operating temperature	0°C to 40°C (32°F to 104°F)
Dimensions (W × H × D)	Approx. 32 × 43.8 × 7.9 mm (1.3 × 1.7 × 0.3 in.) (excluding projections)
Weight	Approx. 22.5 g (0.8 oz) (excluding terminal cover)

**Charging AC Adapter EH-69P**

Rated input	AC 100-240 V, 50/60 Hz, 0.068-0.042 A
Rated capacity	6.8-10.1 VA
Rated output	DC 5.0 V, 550 mA
Operating temperature	0°C to 40°C (32°F to 104°F)
Dimensions (W × H × D)	Approx. 55 × 22 × 54 mm (2.2 × 0.9 × 2.2 in.) (excluding plug adapter) For Argentina: Approx. 55 × 59 × 63 mm (2.2 × 2.4 × 2.5 in.)
Weight	Approx. 55 g (2.0 oz) (excluding plug adapter) For Argentina: Approx. 80 g (2.9 oz)

**✓ Specifications**

Nikon will not be held liable for any errors this manual may contain. The appearance of this product and its specifications are subject to change without notice.

## Supported Standards

- **DCF:** Design Rule for Camera File System is a standard widely used in the digital camera industry to ensure compatibility among different makes of camera.
- **DPOF:** Digital Print Order Format is an industry-wide standard that allows images to be printed from print orders saved on memory card.
- **Exif version 2.3:** This camera supports Exchangeable image file format (Exif) version 2.3 for digital still cameras, a standard that allows information saved with photographs to be used for optimal color reproduction when images are output from Exif-compliant printers.
- **PictBridge:** A standard developed cooperatively by the digital camera and printer industries, allowing photographs to be output directly to a printer without connecting the camera to a computer.



# Index

## Symbols

**T** (Tele) 4

**W** (Wide) 4

**AE/AF-L** 75

 Auto mode 26

 Auto sort mode 95

 Exit icon 14

 Favorite pictures mode 88

 List by date mode 98

 Movie record button 6

 Playback button 5, 6, 32

 Playback mode 32

 Playback zoom 4, 85

 Return icon 14

 Scene mode 59

 Setup menu 149

 Shooting mode button 5, 6

 Smart portrait mode 76

 Thumbnail playback 4, 83

## A

AC adapter 176

AF area 30

AF assist 160

Album 90

Aperture 30

Audio/video cable 134, 176

Audio/video-in jack 134

Auto flash 34

Auto mode 26

Auto off 162

Auto sort mode 95

Autofocus 39

## B

Back light  70

Battery 16, 18, 153

Battery charger 20, 176

Battery latch 5, 16

Battery level indicator 26

Battery-chamber 5

Battery-chamber/memory card slot cover  
5, 16, 24

Beach  66

Best Shot Selector 56

Blink proof 79

Brightness 156

BSS 56

Built-in microphone (stereo) 4, 111

Button sound 161

## C

Charge by computer 165

Charge lamp 5, 19, 142

Charger 18

Charging AC Adapter 18

Close-up  68

Cloudy 57

Compression ratio 45

Computer 137

Connector cover 4

Continuous 56

Copy  70

Copying images 171

Crop 127

## D

Date and time 152

Date format 23, 152

Daylight 57

Daylight saving time 22, 153

Delete 33, 112

Digital zoom 29, 160

Direct print 143

D-Lighting 119

DPOF 196

DPOF print 148

Drag 8

Drag and drop 8

Draw  70, 72



DSCN 178

Dusk/dawn  67

**E**

EH-69P 18  
 EN-EL12 16, 18  
 Exposure compensation 40  
 Extension 178  
 Eyelet for camera strap 4

**F**

Face detection 28, 42  
 Favorite pictures mode 92  
 File names 178  
 Fill flash 34  
 Filter effects 122  
 Fireworks show  69  
 Firmware version 172  
 Fixed range auto 55  
 Flash 4, 34, 35  
 Flash lamp 5, 35  
 Flash off 34  
 Fluorescent 57  
 Focus 7, 30  
 Folder name 178  
 Food  68  
 Format 25, 163  
 Format memory card 25, 163  
 Formatting internal memory 163  
 FSCN 178  
 Full-frame playback 82  
 Full-time AF 131

**G**

Glamour retouch 124

**H**

Halfway 7  
 HD 720p 130  
 HDMI 164  
 HDMI cable 134  
 HDMI device control 164  
 Help 59

**I**

Identifier 178  
 Image mode 45

Image review 156  
 Image size 45  
 Imprinting date and time 157  
 Incandescent 57  
 Internal memory 24  
 Internal memory indicator 27  
 ISO sensitivity 55

**J**

JPG 178

**L**

Landscape  64  
 Language 164  
 Lens 4, 192  
 Lens cover 4  
 Li-ion rechargeable battery 16  
 List by date mode 98

**M**

Macro mode 39  
 Memory card 24, 177  
 Memory card slot 5, 24  
 Menus 151  
 Monitor 5, 10, 175  
 Monitor settings 155  
 Motion detection 159  
 MOV 178  
 Movie AF mode 131  
 Movie length 131  
 Movie options 130  
 Movie playback 133  
 Movie recording 128  
 MSCN 178  
 Multi-shot 16 56  
 Museum  69





**N**

Night landscape  67  
 Night portrait  65  
 Nikon Transfer 2 137, 138  
 Number of exposures remaining 26, 46

**O**

Optional accessories 176

**P**

Paint 115  
Panorama assist  70, 74  
Panorama Maker 5 137, 141  
Paper size 145, 146  
Party/indoor  66  
Perspective control 121  
Pet portrait auto release 71  
Pet portrait  71  
PictBridge 143, 196  
Playback 32, 82, 83, 85, 112, 133, 155  
Playback mode 87  
Portrait  64  
Power 22, 26  
Power switch 4, 26  
Power-on lamp 4, 26  
Preset manual 58  
Press halfway 7  
Print 145, 146  
Print date 109, 157  
Print order 106  
Printer 143

**Q**



Quick retouch 118

**R**

Rating 101  
Rechargeable battery 176  
Rechargeable Li-ion battery 16, 18  
Recording movies 128  
Red-eye reduction 34, 36  
Reset all 168  
Rotate image 110  
RSCN 178

**S**

Scene Auto Selector  62  
Scene mode 59, 64  
Self-timer 37  
Self-timer lamp 4, 38  
Setup menu 149  
Shooting 26, 28, 30, 155

Shooting mode 41  
Shutter sound 161  
Shutter speed 30  
Shutter-release button 4, 30  
Single 56  
Single AF 131  
Skin softening 79  
Slide show 102  
Slow Sync 34  
Small picture 126  
Smart portrait mode 76  
Smile timer 79  
Snow  66  
Sound settings 161  
Speaker 5  
Sports  65  
SSCN 178  
Strap 7  
Stretch 120  
Stylus 9  
Subject tracking 50  
Sunset  66

**T**

Tap 8  
Thumbnail playback 83  
Time zone 22, 152, 154  
Time zone and date 22, 152  
Touch AF/AE 52  
Touch shooting 44  
Touch shutter 47  
Tripod socket 5  
TV 134  
TV settings 164

**U**

USB cable 138, 144  
USB/audio/video output connector 4,  
134, 138, 144

**V**

VGA 130, 131  
Vibration reduction 158

## Index

Video mode 135, 164

ViewNX 2 137, 141

Voice memo 111

Volume 112, 133

### **W**

WAV 178

Welcome screen 151

White balance 57

Wind noise reduction 132

### **Z**

Zoom 29

Zoom control 4, 29



A series of horizontal dashed lines for handwriting practice, starting from the top right and extending across the page.



A series of horizontal dashed lines for handwriting practice, starting from the top right and extending across the page.



# ***Nikon***

No reproduction in any form of this manual, in whole or in part (except for brief quotation in critical articles or reviews), may be made without written authorization from NIKON CORPORATION.



**NIKON CORPORATION**

Printed in Hong Kong

© 2011 Nikon Corporation

CT1C02(11)  
6MM07611-02