

Nikon

DIGITAL CAMERA

COOLPIX S6200

Reference Manual



En

Trademark Information

- Microsoft, Windows and Windows Vista are either registered trademarks or trademarks of Microsoft Corporation in the United States and/or other countries.
- Macintosh, Mac OS, and QuickTime are trademarks of Apple Inc., registered in the U.S. and other countries. The iFrame logo and the iFrame symbol are trademarks of Apple Inc.
- Adobe and Acrobat are registered trademarks of Adobe Systems Inc.
- SDXC, SDHC and SD Logos are trademarks of SD-3C, LLC.
- PictBridge is a trademark.
- HDMI, **HDMI** logo and High-Definition Multimedia Interface are trademarks or registered trademarks of HDMI Licensing LLC.
- All other trade names mentioned in this manual or the other documentation provided with your Nikon product are trademarks or registered trademarks of their respective holders.

AVC Patent Portfolio License

This product is licensed under the AVC Patent Portfolio License for the personal and non-commercial use of a consumer to (i) encode video in compliance with the AVC standard ("AVC video") and/or (ii) decode AVC video that was encoded by a consumer engaged in a personal and non-commercial activity and/or was obtained from a video provider licensed to provide AVC video. No license is granted or shall be implied for any other use. Additional information may be obtained from MPEG LA, L.L.C.

See <http://www.mpegla.com>.

Introduction

Parts of the Camera and Basic Operations

The Basics of Shooting and Playback

Shooting Features

Playback Features

Recording and Playing Back Movies

General Camera Setup

Reference Section

Technical Notes and Index

Read This First

Thank you for purchasing the Nikon COOLPIX S6200 digital camera. Before using the camera, please read the information in "For Your Safety" (vi) and familiarize yourself with the information provided in this manual. After reading, please keep this manual handy and refer to it to enhance your enjoyment of your new camera.

Confirming the Package Contents

In the event that any items are missing, please contact the store where you purchased the camera.



COOLPIX S6200
Digital Camera



Camera Strap



Rechargeable Li-ion Battery
EN-EL12 (with terminal
cover)

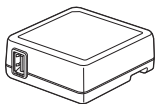

Charging AC Adapter
EH-69P*

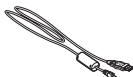

USB Cable UC-E6

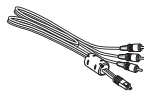

Audio Video Cable EG-CP16



ViewNX 2 Installer CD



Reference Manual CD

- Warranty

* A plug adapter is included if the camera was purchased in a country or region that requires a plug adapter. The shape of the plug adapter varies with the country or region of purchase.

NOTE: A memory card is not included with the camera.

About This Manual





If you want to start using the camera right away, see “The Basics of Shooting and Playback” (📖 13).

To learn about the parts of the camera and basic operations, see “Parts of the Camera and Basic Operations” (📖 1).

Other Information

- Symbols and Conventions

To make it easier to find the information you need, the following symbols and conventions are used in this manual:

Icon	Description
	This icon indicates cautions and information that should be read before using the camera.
	This icon indicates notes and information that should be read before using the camera.
	These icons indicate other pages containing relevant information;  : “Reference Section”,  : “Technical Notes and Index.”

- SD and SDHC/SDXC memory cards are referred to as “memory cards” in this manual.
- The setting at the time of purchase is referred to as the “default setting.”
- The names of menu items displayed in the camera monitor, and the names of buttons or messages displayed on a computer monitor appear in bold.
- In this manual, images are sometimes omitted from monitor display samples so that monitor indicators can be more clearly shown.
- Illustrations and monitor content shown in this manual may differ from the actual product.

Information and Precautions

Life-Long Learning

As part of Nikon's "Life-Long Learning" commitment to ongoing product support and education, continually updated information is available online at the following sites:

- For users in the U.S.A.: <http://www.nikonusa.com/>
- For users in Europe and Africa: <http://www.europe-nikon.com/support/>
- For users in Asia, Oceania, and the Middle East: <http://www.nikon-asia.com/>

Visit these sites to keep up-to-date with the latest product information, tips, answers to frequently asked questions (FAQs), and general advice on digital imaging and photography. Additional information may be available from the Nikon representative in your area. Visit the site below for contact information:

<http://imaging.nikon.com/>

Use Only Nikon Brand Electronic Accessories

Nikon COOLPIX cameras are designed to the highest standards and include complex electronic circuitry. Only Nikon brand electronic accessories (including battery chargers, batteries, Charging AC adapters, and AC adapters) certified by Nikon specifically for use with this Nikon digital camera are engineered and proven to operate within the operational and safety requirements of this electronic circuitry.

THE USE OF NON-NIKON ELECTRONIC ACCESSORIES COULD DAMAGE THE CAMERA AND MAY VOID YOUR NIKON WARRANTY.

The use of third-party rechargeable Li-ion batteries not bearing the Nikon holographic seal could interfere with normal operation of the camera or result in the batteries overheating, igniting, rupturing, or leaking.

For more information about Nikon brand accessories, contact a local authorized Nikon dealer.

Holographic seal: Identifies this device as an authentic Nikon product.



Before Taking Important Pictures

Before taking pictures on important occasions (such as at weddings or before taking the camera on a trip), take a test shot to ensure that the camera is functioning normally. Nikon will not be held liable for damages or lost profits that may result from product malfunction.

About the Manuals

- No part of the manuals included with this product may be reproduced, transmitted, transcribed, stored in a retrieval system, or translated into any language in any form, by any means, without Nikon's prior written permission.
- Nikon reserves the right to change the specifications of the hardware and software described in these manuals at any time and without prior notice.
- Nikon will not be held liable for any damages resulting from the use of this product.

- While every effort was made to ensure that the information in these manuals is accurate and complete, we would appreciate it were you to bring any errors or omissions to the attention of the Nikon representative in your area (address provided separately).

Notice Concerning Prohibition of Copying or Reproduction

Note that simply being in possession of material that was digitally copied or reproduced by means of a scanner, digital camera or other device may be punishable by law.

• Items prohibited by law from being copied or reproduced

Do not copy or reproduce paper money, coins, securities, government bonds or local government bonds, even if such copies or reproductions are stamped "Sample." The copying or reproduction of paper money, coins, or securities which are circulated in a foreign country is prohibited. Unless the prior permission of the government was obtained, the copying or reproduction of unused postage stamps or post cards issued by the government is prohibited.

The copying or reproduction of stamps issued by the government and of certified documents stipulated by law is prohibited.

• Cautions on certain copies and reproductions

The government has issued cautions on copies or reproductions of securities issued by private companies (shares, bills, checks, gift certificates, etc.), commuter passes, or coupon tickets, except when a minimum of necessary copies are to be provided for business use by a company. Also, do not copy or reproduce passports issued by the government, licenses issued by public agencies and private groups, ID cards and tickets, such as passes and meal coupons.

• Comply with copyright notices

The copying or reproduction of copyrighted creative works such as books, music, paintings, woodcut prints, maps, drawings, movies, and photographs is governed by national and international copyright laws. Do not use this product for the purpose of making illegal copies or to infringe copyright laws.

Disposing of Data Storage Devices

Please note that deleting images or formatting data storage devices such as memory cards or built-in camera memory does not completely erase the original image data. Deleted files can sometimes be recovered from discarded storage devices using commercially available software, potentially resulting in the malicious use of personal image data. Ensuring the privacy of such data is the user's responsibility.

Before discarding a data storage device or transferring ownership to another person, erase all data using commercial deletion software, or format the device and then completely refill it with images containing no private information (for example, pictures of empty sky). Be sure to also replace any pictures selected for the **Select an image** option in the **Welcome screen** setting (📖 88). Care should be taken to avoid injury or damage to property when physically destroying data storage devices.

For Your Safety

To prevent damage to your Nikon product or injury to yourself or to others, read the following safety precautions in their entirety before using this equipment. Keep these safety instructions where all those who use the product will read them.



This icon marks warnings, information that should be read before using this Nikon product, to prevent possible injury.

WARNINGS

Turn off in the event of malfunction

Should you notice smoke or an unusual smell coming from the camera or Charging AC Adapter, unplug the Charging AC Adapter and remove the battery immediately, taking care to avoid burns. Continued operation could result in injury. After removing or disconnecting the power source, take the equipment to a Nikon-authorized service representative for inspection.

Do not disassemble

Touching the internal parts of the camera or Charging AC Adapter could result in injury. Repairs should be performed only by qualified technicians. Should the camera or Charging AC Adapter break open as the result of a fall or other accident, take the product to a Nikon-authorized service representative for inspection, after unplugging the product and/or removing the battery.

Do not use the camera or Charging AC Adapter in the presence of flammable gas

Do not use electronic equipment in the presence of flammable gas, as this could result in explosion or fire.

Handle the camera strap with care

Never place the strap around the neck of an infant or child.

Keep out of reach of children

Particular care should be taken to prevent infants from putting the battery or other small parts into their mouths.

Do not remain in contact with the camera, battery charger, or AC adapter for extended periods while the devices are on or in use

Parts of the devices become hot. Leaving the devices in direct contact with the skin for extended periods may result in low-temperature burns.

Observe caution when handling the battery

The battery may leak, overheat, or explode if improperly handled. Observe the following precautions when handling the battery for use in this product:

- Before replacing the battery, turn the product off. If you are using the Charging AC Adapter/AC adapter, be sure it is unplugged.
- Use only a Rechargeable Li-ion Battery EN-EL12 (included). Charge the battery by using a camera that supports battery charging or by using a Battery Charger MH-65 (available separately). To charge the battery with the camera, use either Charging AC Adapter EH-69P (included) or the **Charge by computer** function.
- When inserting the battery, do not attempt to insert it upside down or backwards.
- Do not short or disassemble the battery or attempt to remove or break the battery insulation or casing.
- Do not expose the battery to flame or to excessive heat.
- Do not immerse in or expose to water.
- Replace the terminal cover before transporting it. Do not transport or store with metal objects such as necklaces or hairpins.
- The battery is prone to leakage when fully discharged. To avoid damage to the product, be sure to remove the battery when no charge remains.
- Discontinue use immediately should you notice any change in the battery, such as discoloration or deformation.

Observe the following precautions when handling the Charging AC Adapter

- If liquid from the damaged battery comes in contact with clothing or skin, rinse immediately with plenty of water.
- Keep dry. Failure to observe this precaution could result in fire or electric shock.
- Dust on or near the metal parts of the plug should be removed with a dry cloth. Continued use could result in fire.
- Do not handle the plug or go near the Charging AC Adapter during lightning storms. Failure to observe this precaution could result in electric shock.
- Do not damage, modify, forcibly tug or bend the USB cable, place it under heavy objects, or expose it to heat or flames. Should the insulation be damaged and the wires become exposed, take it to a Nikon-authorized service representative for inspection. Failure to observe these precautions could result in fire or electric shock.
- Do not handle the plug or Charging AC Adapter with wet hands. Failure to observe this precaution could result in electric shock.
- Do not use with travel converters or adapters designed to convert from one voltage to another or with DC-to-AC inverters. Failure to observe this precaution could damage the product or cause overheating or fire.

⚠ Use appropriate cables

When connecting cables to the input and output jacks, use only the cables provided or sold by Nikon for the purpose, to maintain compliance with product regulations.

⚠ Handle moving parts with care

Be careful that your fingers or other objects are not pinched by the lens cover or other moving parts.

⚠ CD-ROMs

The CD-ROMs included with this device should not be played back on audio CD equipment. Playing CD-ROMs on an audio CD player could cause hearing loss or damage the equipment.

⚠ Observe caution when using the flash

Using the flash close to your subject's eyes could cause temporary visual impairment. Particular care should be observed if photographing infants, when the flash should be no less than 1 m (3 ft 4 in.) from the subject.

⚠ Do not operate the flash with the flash window touching a person or object

Failure to observe this precaution could result in burns or fire.

⚠ Avoid contact with liquid crystal

Should the monitor break, care should be taken to avoid injury caused by broken glass and to prevent liquid crystal from the monitor touching the skin or entering the eyes or mouth.

⚠ Turn the power off when using inside an airplane or the hospital

Turn the power off while inside the airplane during take off or landing. Follow the instructions of the hospital when using while in a hospital. The electromagnetic waves given out by this camera may disrupt the electronic systems of the airplane or the instruments of the hospital.

Notices

Notices for Customers in the U.S.A.

IMPORTANT SAFETY INSTRUCTIONS -

SAVE THESE INSTRUCTIONS.

DANGER - TO REDUCE THE RISK OF FIRE OR ELECTRIC SHOCK, CAREFULLY FOLLOW THESE INSTRUCTIONS

For connection to a supply not in the U.S.A., use an attachment plug adapter of the proper configuration for the power outlet if needed.

The power supply unit is intended to be correctly orientated in a vertical or floor mount position.

Federal Communications Commission (FCC) Radio Frequency Interference Statement

This equipment has been tested and found to comply with the limits for a Class B digital device, pursuant to Part 15 of the FCC rules. These limits are designed to provide reasonable protection against harmful interference in a residential installation. This equipment generates, uses, and can radiate radio frequency energy and, if not installed and used in accordance with the instructions, may cause harmful interference to radio communications. However, there is no guarantee that interference will not occur in a particular installation. If this

equipment does cause harmful interference to radio or television reception, which can be determined by turning the equipment off and on, the user is encouraged to try to correct the interference by one or more of the following measures:

- Reorient or relocate the receiving antenna.
- Increase the separation between the equipment and receiver.
- Connect the equipment into an outlet on a circuit different from that to which the receiver is connected.
- Consult the dealer or an experienced radio/television technician for help.



Nikon

COOLPIX S6200

CAUTIONS

Modifications

The FCC requires the user to be notified that any changes or modifications made to this device that are not expressly approved by Nikon Corporation may void the user's authority to operate the equipment.

Interface Cables

Use the interface cables sold or provided by Nikon for your equipment. Using other interface cables may exceed the limits of Class B Part 15 of the FCC rules.

Notice for customers in the State of California

WARNING

Handling the cord on this product will expose you to lead, a chemical known to the State of California to cause birth defects or other reproductive harm.

Wash hands after handling.

Nikon Inc.,
1300 Walt Whitman Road
Melville, New York 11747-3064
USA
Tel: 631-547-4200

Notice for customers in Canada

CAUTION

This Class B digital apparatus complies with Canadian ICES-003.

ATTENTION

Cet appareil numérique de la classe B est conforme à la norme NMB-003 du Canada.

Notices for customers in Europe

CAUTIONS

RISK OF EXPLOSION IF BATTERY IS REPLACED BY AN INCORRECT TYPE.

DISPOSE OF USED BATTERIES ACCORDING TO THE INSTRUCTIONS.

This symbol indicates that this product is to be collected separately.



The following apply only to users in European countries:

- This product is designated for separate collection at an appropriate collection point. Do not dispose of as household waste.
- For more information, contact the retailer or the local authorities in charge of waste management.

This symbol on the battery indicates that the battery is to be collected separately.















The following apply only to users in European countries:







































- All batteries, whether marked with this symbol or not, are designated for separate collection at an appropriate collection point. Do not dispose of as household waste.
- For more information, contact the retailer or the local authorities in charge of waste management.

Table of Contents

Introduction	ii
Read This First	ii
Confirming the Package Contents	ii
About This Manual	iii
Information and Precautions	iv
For Your Safety	vi
WARNINGS	vi
Notices	ix
Parts of the Camera and Basic Operations	1
Parts of the Camera	2
The Camera Body	2
Controls Used in Shooting Mode	4
Controls Used in Playback Mode	5
The Monitor	6
Basic Operations	8
Switching Between Shooting Mode and Playback Mode	8
Using the Rotary Multi Selector	9
Using Menus (the MENU Button)	10
Attaching the Camera Strap	12
The Basics of Shooting and Playback	13
Preparation 1 Insert the Battery	14
Preparation 2 Charge the Battery	16
Preparation 3 Insert a Memory Card	18
Internal Memory and Memory Cards	19
Approved Memory Cards	19
Step 1 Turn the Camera On	20
Turning the Camera On and Off	21
Setting the Display Language, Date, and Time	22
Step 2 Select a Shooting Mode	24
Available Shooting Modes	25
Step 3 Frame a Picture	26
Using the Zoom	27
Step 4 Focus and Shoot	28
Step 5 Play Back Images	30
Changing How Images Are Displayed	31
Step 6 Delete Unwanted Images	32
Shooting Features	35
📷 (Auto) Mode	36
Changing 📷 (Auto) Mode Settings	36
Options Available in the Auto Shooting Menu	37

Scene Mode (Shooting Suited to Scenes)	39
Changing Scene Mode Settings.....	39
Characteristics of Each Scene.....	40
Special Effects Mode (Applying Effects When Shooting)	47
Changing Special Effects Mode Settings.....	48
Smart Portrait Mode (Shooting Smiling Faces)	49
Changing Smart Portrait Mode Settings	50
Options Available in the Smart Portrait Menu.....	50
Subject Tracking Mode (Focusing on a Moving Subject)	51
Changing Subject Tracking Mode Settings.....	52
Options Available in the Subject Tracking Menu	53
Features That Can Be Set Using the Multi Selector.....	55
Available Features	55
Using the Flash (Flash Modes).....	56
Using the Self-timer	58
Using Macro Mode	59
Adjusting Brightness (Exposure Compensation).....	60
Default Settings	61
Changing the Image Size (Image Mode)	63
Image Mode Settings (Image Size and Quality)	63
Features That Cannot Be Used Simultaneously.....	65
Using Face Detection.....	67
Using Skin Softening.....	69
Focus Lock	70
<hr/>	
Playback Features.....	71
Selecting Certain Types of Images for Playback	72
Available Playback Modes.....	72
Switching Between Playback Modes	72
Features Available in Playback Mode (Playback Menu)	73
Connecting the Camera to a TV, Computer, or Printer	74
Using ViewNX 2	75
Installing ViewNX 2	75
Transferring Images to the Computer	77
Viewing Images.....	78
Retouching Photographs	79
Editing Movies.....	79
Printing Images.....	79
<hr/>	
Recording and Playing Back Movies.....	81
Recording Movies	82
Changing Movie Recording Settings (the Movie Menu)	85
Playing Back Movies.....	86
<hr/>	
General Camera Setup.....	87
The Setup Menu	88

Reference Section	01
Using Panorama Assist.....	02
Favorite Pictures Mode	04
Adding Images to Albums.....	04
Playing Back Images in Albums.....	05
Removing Images from Albums	05
Changing the Favorites Album Icon.....	06
Auto Sort Mode	07
Auto Sort Mode Categories.....	07
List by Date Mode	09
Editing Still Images.....	10
Editing Features.....	10
 Quick Retouch: Enhancing Contrast and Saturation	12
 D-Lighting: Enhancing Brightness and Contrast.....	13
 Skin Softening: Softening Skin Tones.....	14
 Filter Effects: Applying Digital Filter Effects.....	16
 Small Picture: Reducing the Size of an Image.....	18
 Crop: Creating a Cropped Copy	19
Connecting the Camera to a TV (Viewing Images on a TV)	21
Connecting the Camera to a Printer (Direct Print).....	23
Connecting the Camera to a Printer.....	24
Printing Individual Images	26
Printing Multiple Images.....	27
The Shooting Menu (for  (Auto) Mode)	30
White Balance (Adjusting Hue).....	30
Continuous Shooting.....	32
ISO Sensitivity.....	33
Color Options.....	34
AF Area Mode	35
Autofocus Mode.....	37
The Smart Portrait Menu	38
Skin Softening.....	38
Smile Timer.....	38
Blink Proof.....	39
The Subject Tracking Menu.....	40
Autofocus Mode.....	40
Face Priority Tracking	40
The Playback Menu	41
 Print Order (Creating a DPOF Print Order).....	41
 Slide Show.....	45
 Protect.....	46
 Rotate Image.....	48
 Voice Memo.....	49
 Copy (Copy Between Internal Memory and Memory Card)	51

The Movie Menu	 52
Movie Options.....	 52
Autofocus Mode.....	 53
Wind Noise Reduction.....	 53
The Setup Menu	 54
Welcome Screen.....	 54
Time Zone and Date.....	 55
Monitor Settings.....	 58
Print Date (Imprinting Date and Time).....	 60
Vibration Reduction.....	 61
Motion Detection.....	 62
AF Assist.....	 63
Digital Zoom.....	 63
Sound Settings.....	 64
Auto Off.....	 65
Format Memory/Format Card.....	 66
Language.....	 67
TV Settings.....	 68
Charge by Computer.....	 69
Blink Warning.....	 71
Filmstrip.....	 73
Reset All.....	 74
Firmware Version.....	 76
File and Folder Names	 77
Optional Accessories	 78
Error Messages	 79
<hr/>	
Technical Notes and Index	 1
Caring for the Product	 2
The Camera.....	 2
The Battery.....	 4
Charging AC Adapter.....	 5
Memory Cards.....	 5
Cleaning and Storage	 6
Cleaning.....	 6
Storage.....	 6
Troubleshooting	 7
Specifications	 14
Supported Standards.....	 18
Index	 19

Parts of the Camera and Basic Operations

This chapter describes the parts of the camera and also explains how to use basic camera features.

Parts of the Camera	2
The Camera Body	2
Controls Used in Shooting Mode	4
Controls Used in Playback Mode	5
The Monitor	6
Basic Operations	8
Switching Between Shooting Mode and Playback Mode	8
Using the Rotary Multi Selector.....	9
Using Menus (the MENU Button)	10
Attaching the Camera Strap.....	12

➔ If you want to start using the camera right away, see “The Basics of Shooting and Playback” (📖 13).

Parts of the Camera

The Camera Body

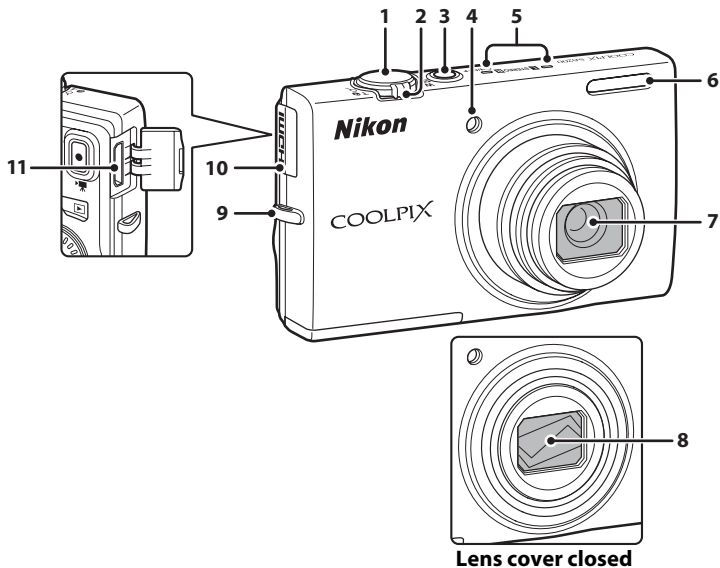





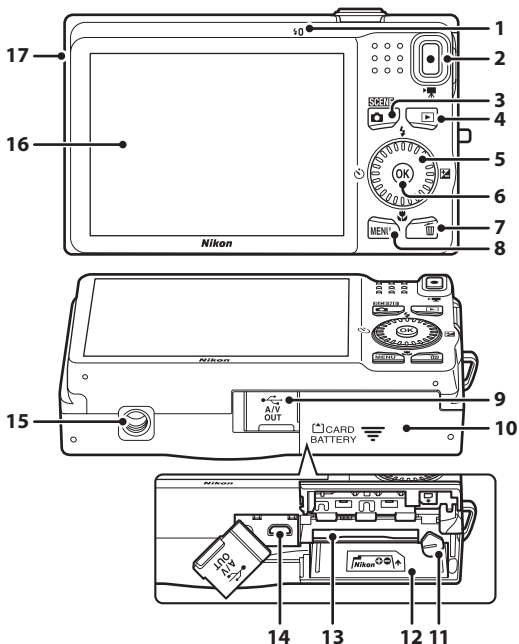

Lens cover closed

1	Shutter-release button.....4, 5, 28
2	Zoom control.....4, 5, 27
	W : wide.....4, 27
	T : tele.....4, 27
	: thumbnail playback.....5, 31
	: playback zoom5, 31
	: help.....39
3	Power switch/power-on lamp.....20
4	Self-timer lamp58
	AF-assist illuminator.....89









5	Microphone (stereo).....73, 82
6	Flash.....56
7	Lens
8	Lens cover
9	Eyelet for camera strap.....12
10	HDMI connector cover.....74
11	HDMI mini connector (Type C).....74





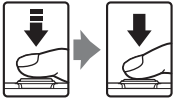







1	Charge lamp.....17, 	69
	Flash lamp.....	56
2	 (movie-record) button....	4, 5, 8, 2
3	 (shooting mode) button4, 5, 8, 24
4	 (playback) button	4, 5, 8, 30, 72
5	Rotary multi selector (multi selector)	9
6	 (apply selection) button	5, 9
7	 (delete) button	4, 5, 32, 73
8	MENU button.....	4, 5, 10, 37, 73, 85, 88
9	Connector cover	16, 74

10	Battery-chamber/ memory card slot cover.....	14, 15
11	Battery latch	14
12	Battery chamber.....	14
13	Memory card slot.....	18
14	USB/audio/video output connector 16, 74
15	Tripod socket.....	 16
16	Monitor	6, 24
17	Speaker.....	73, 86

Controls Used in Shooting Mode

Control	Name	Main Function	
	Shooting mode button	Changes the shooting mode (displays the shooting-mode selection screen).	24
	Zoom control	Zooms in and out; rotate to T (Q) to zoom in and make the subject larger, and rotate to W (E) to zoom out and view a wider area.	27
	Rotary multi selector	See “Using the Rotary Multi Selector” for more information.	9, 10
	MENU button	Displays and hides the menu.	10, 37, 85, 88
	Shutter-release button	When pressed halfway (i.e., if you stop pressing when you feel resistance): Sets focus and exposure. When pressed all the way: Releases the shutter.	28
	Movie-record button	Starts and stops movie recording.	82
	Playback button	Plays back images.	8, 30, 72, 86
	Delete button	Deletes the last image that was saved.	32

Controls Used in Playback Mode

Control	Name	Main Function	
	Playback button	<ul style="list-style-type: none"> Changes the playback mode (displays the playback-mode selection screen). When the camera is off, press and hold this button to turn the camera on and to change to playback mode. 	72 21, 30
	Zoom control	<ul style="list-style-type: none"> When rotated to T (Q): Magnifies the image. When rotated to W (checkered flag): Displays thumbnails or the calendar. Adjusts the volume when playing back voice memos and movies. 	31 31 73, 86,  49
	Rotary multi selector	See "Using the Rotary Multi Selector" for more information.	9, 10
	Apply selection button	<ul style="list-style-type: none"> Switches from image thumbnail or zoomed image display to full-frame display. Adds images to albums, removes images from albums. Plays back movies. 	31 72 86
	MENU button	Displays and hides the menu.	10, 73, 88
	Delete button	Deletes images.	32
	Shooting mode button	Returns to shooting.	–
	Shutter-release button		–
	Movie-record button		–

The Monitor

- The information that is displayed in the monitor during shooting and playback changes depending on the camera's settings and state of use.

By default, information is displayed when the camera is first turned on and when you operate the camera, and turns off after a few seconds (when

Monitor settings (📖 88) → **Photo info** is set to **Auto info**).

Shooting Mode

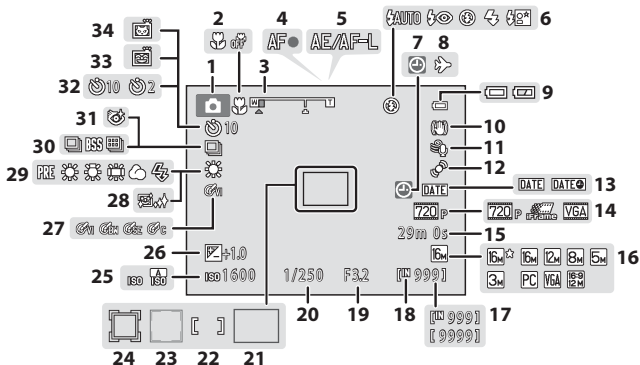

1	Shooting mode	24, 25	19	Aperture value.....	28
2	Macro mode	59	20	Shutter speed.....	28
3	Zoom indicator.....	27, 59	21	Focus area (auto)	28, 37
4	Focus indicator	28	22	Focus area (for manual or center).....	37
5	AE/AF-L indicator	👁️ 2	23	Focus area (face detection, pet detection).....	37, 46, 49
6	Flash mode.....	56	24	Focus area (subject tracking mode)	37, 51
7	"Date not set" indicator.....	23, 88, 👁️ 79	25	ISO sensitivity	37
8	Travel destination icon.....	88	26	Exposure compensation value.....	60
9	Battery level indicator	20	27	Color options.....	37
10	Vibration reduction icon.....	88	28	Skin softening	50
11	Wind noise reduction	85	29	White balance mode.....	37
12	Motion detection icon	89	30	Continuous shooting mode	37
13	Print date	88	31	Blink proof icon	50
14	Movie options.....	85	32	Self-timer indicator	58
15	Movie length.....	82	33	Smile timer.....	50
16	Image mode	63	34	Pet portrait auto release	46
17	Number of exposures remaining (still images).....	20			
18	Internal memory indicator.....	20			

Playback Mode

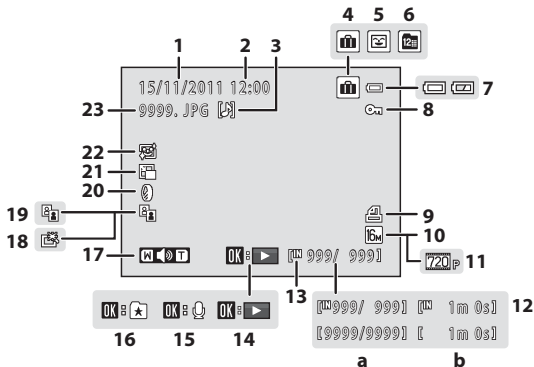



1	Date of recording.....	22	13	Internal memory indicator.....	30
2	Time of recording.....	22		Movie playback indicator.....	86
3	Voice memo indicator.....	73,	14	Voice memo playback guide.....	73,
4	Album icon in favorite pictures mode.....	72,	15	Voice memo recording guide.....	73,
5	Category icon in auto sort mode.....	72,	16	Add to album guide.....	9,
6	List by date icon.....	72,	17	Volume indicator.....	73, 86,
7	Battery level indicator.....	20	18	Quick retouch icon.....	73
8	Protect icon.....	73	19	D-Lighting icon.....	73
9	Print order icon.....	73	20	Filter effects icon.....	73
10	Image mode.....	63	21	Small picture icon.....	73
11	Movie options.....	85	22	Skin softening icon.....	73
12	(a) Current image number/ total number of images.....	30	23	File number and type.....	
	(b) Movie length.....	86			

Basic Operations

Switching Between Shooting Mode and Playback Mode





The camera has two modes of operation: Shooting mode, which is used for taking pictures, and playback mode, which is used for viewing pictures.

To switch to playback mode, press the  (playback) button.

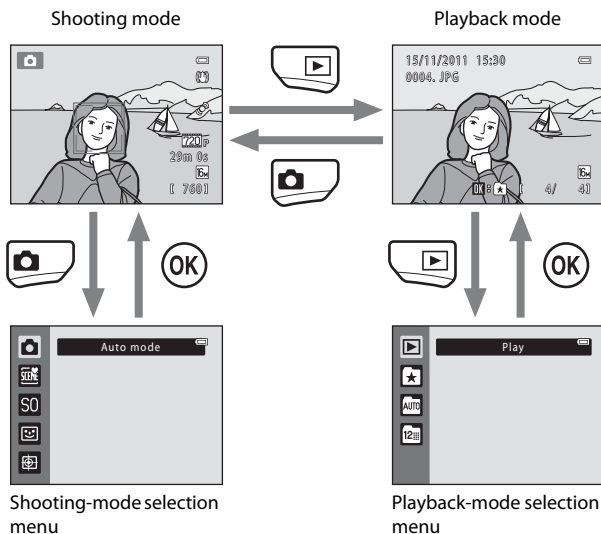
To switch to shooting mode, press the  (shooting mode) button.

- While using playback mode, you can also switch to shooting mode by pressing the shutter-release button or the  (movie-record) button.



- If you press the  (shooting mode) button while using shooting mode, the shooting-mode selection menu is displayed, from which you can select one of the available shooting modes ( 25).
- If you press the  (playback) button while using playback mode, the playback-mode selection menu is displayed, from which you can select one of the available playback modes ( 72).

Using the Rotary Multi Selector

Rotate the rotary multi selector, press its upper (▲), lower (▼), left (◀), or right side (▶), or press the **OK** button.

- The rotary multi selector is sometimes referred to as “the multi selector” in this manual.

In Shooting Mode

Rotate to select an item.*

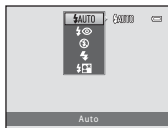
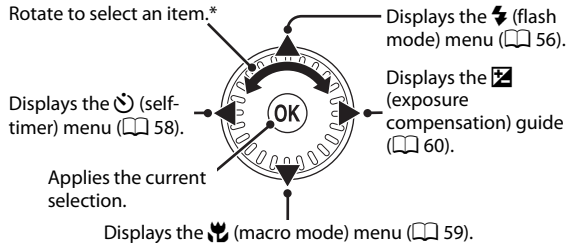

* Items can also be selected by pressing the rotary multi selector up or down.

In Playback Mode

Selects the previous image, moves the displayed area when the image is magnified (31).¹

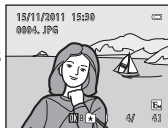
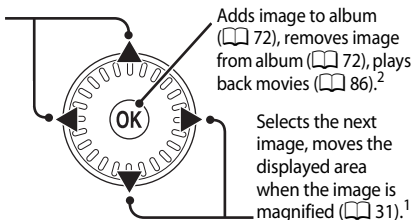

¹ Previous or subsequent images can also be selected by rotating the rotary multi selector.

² When displaying image thumbnails or when the image is magnified, this button switches the camera to full-frame display.

When Displaying Menus

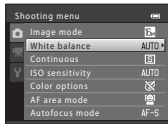
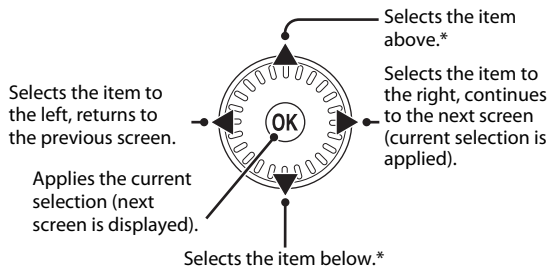

* Items can also be selected by rotating the rotary multi selector.

Using Menus (the MENU Button)

If you press the **MENU** button while the shooting screen or playback screen is displayed, the menu for the current mode is displayed. Once the menu is displayed, you can change various settings.

Shooting mode

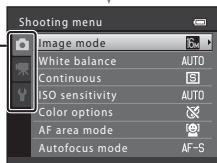
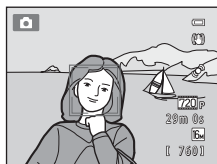

Tab



Displays the settings that can be changed for the current shooting mode (📖 24). Depending on the current shooting mode, the tab icon that is displayed will be different.



Displays movie recording settings.



Displays the setup menu, where you can change a number of general settings.

Playback mode

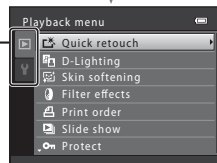
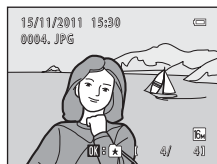

Tab



Displays the settings that can be changed for the current playback mode (📖 72). Depending on the current playback mode, the tab icon that is displayed will be different.



Displays the setup menu, where you can change a number of general settings.

If Tabs Are Not Displayed

If you press the **MENU** button and the screen that allows you to change the image mode is displayed, press the rotary multi selector  to display the tabs.

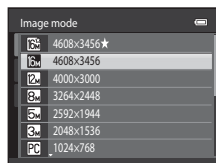

Switching Between Tabs

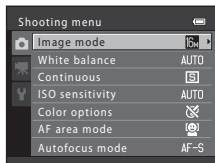

Press the rotary multi selector ◀ to highlight the tab.

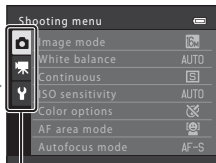

Press the rotary multi selector ▲ or ▼ to select a tab, and press either the **OK** button or ▶.

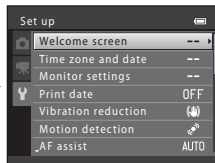

The selected menu is displayed.

Selecting Menu Items

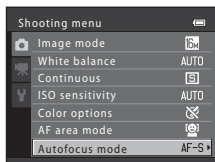

Press the rotary multi selector ▲ or ▼ to select an item, and then press ▶ or the **OK** button.

Items can also be selected by rotating the rotary multi selector.

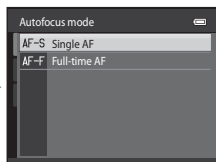

Press ▲ or ▼ to select an item and then press the **OK** button.

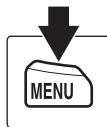

When you are finished changing settings, press the **MENU** button to exit the menu.

When the Menu Contains Two or More Pages

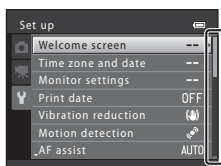

A guide indicating the page position is displayed.

Attaching the Camera Strap

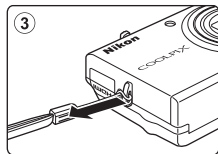
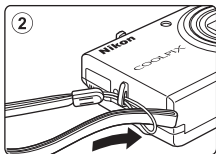
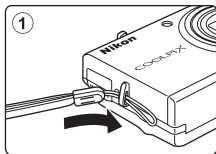



The Basics of Shooting and Playback

Preparation

Preparation 1 Insert the Battery	14
Preparation 2 Charge the Battery	16
Preparation 3 Insert a Memory Card	18



Shooting

Step 1 Turn the Camera On	20
Setting the Display Language, Date, and Time (First Use After Purchase)	22
Step 2 Select a Shooting Mode	24
Step 3 Frame a Picture	26
Step 4 Focus and Shoot	28



Playback

Step 5 Play Back Images	30
Step 6 Delete Unwanted Images	32

Preparation 1 Insert the Battery

- 1 Open the battery-chamber/memory card slot cover.

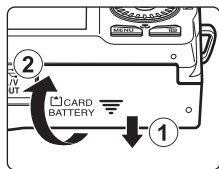

- 2 Insert the included EN-EL12 battery (rechargeable Li-ion battery).

- Use the battery to push the orange battery latch in the direction indicated by the arrow (1), and fully insert the battery (2).
- When the battery is inserted correctly, the battery latch will lock the battery in place.

Battery latch

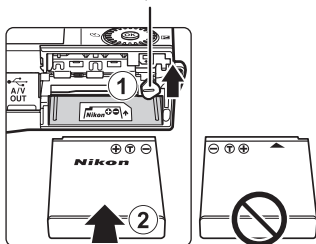

✓ Inserting the Battery Correctly

Inserting the battery upside down or backwards could damage the camera. Be sure to check that the battery is in the correct orientation.

- 3 Close the battery-chamber/memory card slot cover.

- Charge the battery before the first use or when the battery is running low. See “Preparation 2 Charge the Battery” (16) for more information.

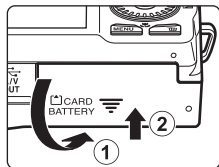

Removing the Battery

Turn the camera off and be sure that the power-on lamp and the monitor have turned off before opening the battery-chamber/memory card slot cover.

To eject the battery, open the battery-chamber/memory card slot cover and slide the orange battery latch up in the direction indicated by the arrow (①). The battery can then be removed by hand (②). Do not pull it at an angle.

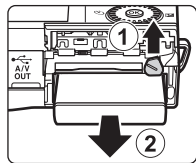

High Temperature Caution

The camera, battery, and memory card may be hot immediately after using the camera. Observe caution when removing the battery or memory card.

Notes About the Battery

Be sure to read and follow the warnings for the battery on page vii and in “The Battery” (⚙️4) before use.

Preparation 2 Charge the Battery

1 Prepare the included Charging AC Adapter EH-69P.

If a plug adapter* is included with your camera, attach the plug adapter to the plug on the Charging AC Adapter. Push the plug adapter firmly until it is securely held in place. Once the two are connected, attempting to forcibly remove the plug adapter could damage the product.

* The shape of the plug adapter varies according to the country or region in which the camera was purchased.

The Charging AC Adapter comes with the plug adapter attached in Argentina, Brazil, and Korea.

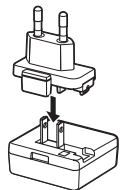
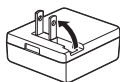

2 Make sure the battery is installed in the camera, and then connect the camera to the Charging AC Adapter in order of ① to ③.

- Keep the camera turned off.
- When connecting the cable, be sure that the camera connector is properly oriented. Do not use force when connecting the cable to the camera. When disconnecting the cable, do not pull the connector at an angle.

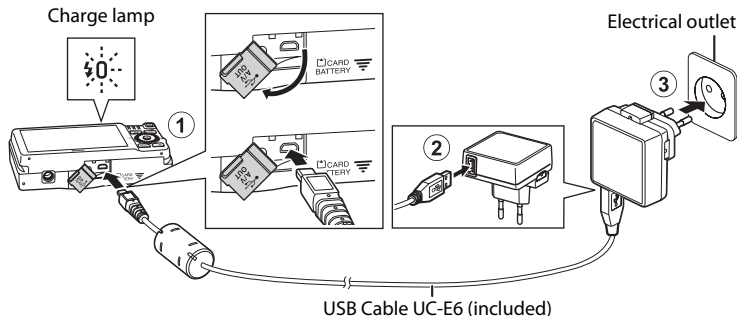

- The charge lamp slowly blinks green to indicate that the battery is charging.
- About 3 hours and 20 minutes are required to charge a fully exhausted battery.
- When the battery has been completely charged, the charge lamp turns off.
- See “The Charge Lamp” (📖 17) for more information.

3 Disconnect the Charging AC Adapter from the electrical outlet and then disconnect the USB cable.

- When the camera is connected to an electrical outlet with the Charging AC Adapter, the camera cannot be turned on.

The Charge Lamp

Status	Description
Blinks slowly (green)	The battery is charging.
Off	The battery is not charging. When charging is complete, the charge lamp stops blinking green and turns off.
Flickers (green)	<ul style="list-style-type: none"> The ambient temperature is not suited to charging. Charge the battery indoors with an ambient temperature of 5 °C to 35 °C (41 °F to 95 °F). The USB cable or Charging AC Adapter is not properly connected, or there is a problem with the battery. Disconnect the USB cable or unplug the Charging AC Adapter and correctly connect it again, or change the battery.

Notes About the Charging AC Adapter

Be sure to read and follow the warnings for the Charging AC Adapter EH-69P on page vii and in “Charging AC Adapter” (🔍5) before use.

Charging Using a Computer or Battery Charger

- You can also charge the Rechargeable Li-ion Battery EN-EL12 by connecting the camera to a computer (📖74, 📷69).
- You can use the Battery Charger MH-65 (available separately; 📷78) to charge the EN-EL12 without using the camera.

Notes About an AC Power Source

- You can use the AC Adapter EH-62F (available separately; 📷78) to supply power to the camera from an electrical outlet for taking pictures and playing back images.
- Do not, under any circumstances, use another make or model of AC adapter other than the EH-62F. Failure to observe this precaution could result in overheating or in damage to the camera.

Preparation 3 Insert a Memory Card

- 1 Be sure that the power-on lamp and the monitor are off and open the battery-chamber/memory card slot cover.
 - Be sure to turn off the camera before opening the cover.

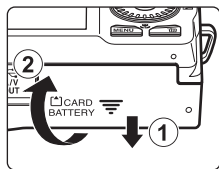

- 2 Insert the memory card.
 - Slide the memory card in until it clicks into place.

✓ Inserting the Memory Card

Inserting the memory card upside down or backwards could damage the camera and the memory card. Be sure to check that the memory card is in the correct orientation.

Memory card slot

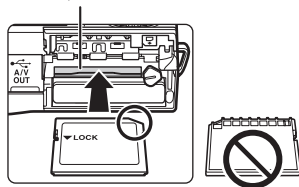

- 3 Close the battery-chamber/memory card slot cover.

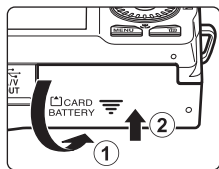

✓ Formatting Memory Cards

- The first time you insert a memory card that has been used in another device into this camera, be sure to format it with this camera.
- **All data stored on a memory card is permanently deleted when the card is formatted.** If there is data saved on the memory card that you wish to keep, copy that data to a computer before formatting.
- To format a memory card, insert the card into the camera, press the **MENU** button, and select **Format card** in the setup menu (📖 88).

✓ Notes About Memory Cards

See "Memory Cards" (🔍 5) and the documentation included with your memory card for more information.

Removing Memory Cards

Turn the camera off and be sure that the power-on lamp and the monitor have turned off before opening the battery-chamber/memory card slot cover.

Gently push the memory card into the camera (①) to partially eject the card, and then remove the card (②). Do not pull it at an angle.

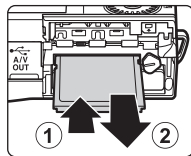

High Temperature Caution

The camera, battery, and memory card may be hot immediately after using the camera. Observe caution when removing the battery or memory card.

Internal Memory and Memory Cards

Camera data, including images and movies, can be saved in either the camera's internal memory (approximately 74 MB) or on a memory card. To use the camera's internal memory for shooting or playback, first remove the memory card.

Approved Memory Cards

The following Secure Digital (SD) memory cards have been tested and approved for use in this camera.

- Memory cards with an SD Speed Class rating of 6 or faster are recommended for recording movies. When using a memory card with a lower Speed Class rating, movie recording may stop unexpectedly.

	SD memory card	SDHC memory card ²	SDXC memory card ³
SanDisk	2 GB ¹	4 GB, 8 GB, 16 GB, 32 GB	64 GB
TOSHIBA	2 GB ¹	4 GB, 8 GB, 16 GB, 32 GB	64 GB
Panasonic	2 GB ¹	4 GB, 8 GB, 12 GB, 16 GB, 32 GB	48 GB, 64 GB
Lexar	–	4 GB, 8 GB, 16 GB, 32 GB	–

¹ If the memory card will be used with a card reader or similar device, make sure that the device supports 2 GB cards.

² SDHC compliant.

If the memory card will be used with a card reader or similar device, make sure that the device supports SDHC.

³ SDXC compliant.

If the memory card will be used with a card reader or similar device, make sure that the device supports SDXC.

- Contact the manufacturer for details on the above cards. We cannot guarantee camera performance when using memory cards made by other manufacturers.



Step 1 Turn the Camera On

1 Press the power switch to turn on the camera.

- **If you are turning the camera on for the first time after purchase**, see “Setting the Display Language, Date, and Time” (📖 22).
- The lens extends and the monitor turns on.

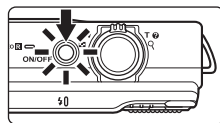

2 Check the battery level indicator and the number of exposures remaining.

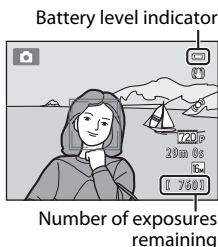

Battery level indicator

Display	Description
	The battery level is high.
	The battery level is low. Prepare to charge or replace the battery.
 Battery exhausted.	The camera cannot take pictures. Recharge or replace with a fully charged battery.

Number of Exposures Remaining

The number of pictures that can be taken is displayed.

- is displayed when no memory card is inserted in the camera, and images will be saved in the internal memory (approx. 74 MB).
- The number of exposures remaining depends on the amount of available memory in the internal memory or memory card, and also varies depending on the image quality and image size (determined by the image mode setting; 📖 64).
- The number of remaining exposures shown in the illustrations in this manual is for example purposes only.

Turning the Camera On and Off

- When the camera is turned on, the power-on lamp (green) will light and then the monitor will turn on (the power-on lamp turns off when the monitor turns on).
- To turn off the camera, press the power switch. When the camera turns off, the power-on lamp and the display turn off.
- To turn on the camera and switch to playback mode, press and hold the  (playback) button. The lens will not extend.

Power Saving Function (Auto Off)

If no operations are performed for a while, the monitor will turn off, the camera will enter standby mode, and the power-on lamp will blink. If no operations are performed for another three minutes, the camera will turn off automatically.

While the camera is in standby mode, the monitor turns back on if you perform any of the following operations:

- Press the power switch, shutter-release button,  (shooting mode) button,  (playback) button, or  (movie-record) button

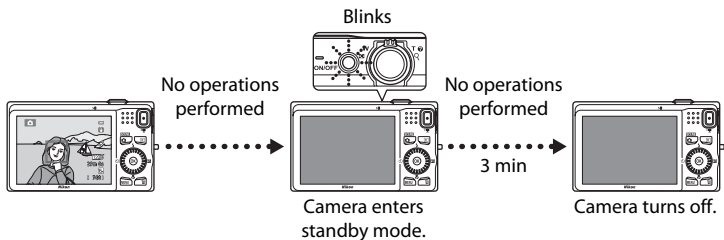

- The time that elapses before the camera enters standby mode can be changed using the **Auto off** setting in the setup menu (📖 88).
- By default, the camera enters standby mode in about one minute when you are using shooting mode or playback mode.
- If you are using the optional AC Adapter EH-62F, the camera enters standby mode after 30 minutes.

Setting the Display Language, Date, and Time

When the camera is turned on for the first time, the language-selection screen and the date and time setting screen for the camera clock are displayed.

- 1** Press the multi selector ▲ or ▼ to select the desired language and press the **OK** button.



Multi selector

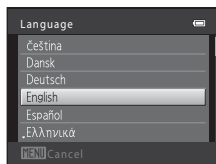

- 2** Press ▲ or ▼ to select **Yes** and press the **OK** button.

- To cancel without changing the setting, select **No**.

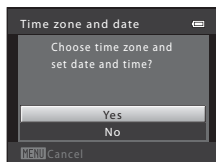

- 3** Press ◀ or ▶ to select your home time zone and press the **OK** button.

- See “Daylight Saving Time” (📖 23) for information about daylight saving time.

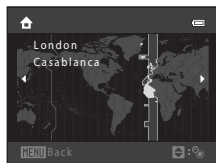
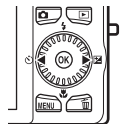

- 4** Press ▲ or ▼ to select the date format and press the **OK** button or ▶.

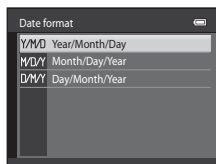

- 5** Press ▲, ▼, ◀, or ▶ to set the date and time, and press the **OK** button.

- Select an item: Press ▶ or ◀ (changes between **D**, **M**, **Y**, **hour**, and **minute**).
- Edit the highlighted item: Rotate the multi selector, or press ▲ or ▼.
- Apply the setting: Select the **minute** setting and press the **OK** button or ▶.
- When settings are finished, the lens extends and the camera switches to shooting mode.

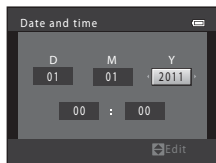



Daylight Saving Time

If daylight saving time is in effect, press the multi-selector ▲ to enable the daylight saving time function while setting the region in step 3. When the daylight saving time function is enabled, ☀️ is displayed at the top of the monitor.

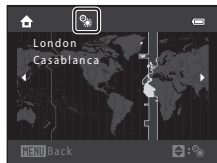
Press ▼ to disable the daylight saving time function.



Changing the Language Setting and the Date and Time Setting

- You can change these settings using the **Language** and **Time zone and date** settings in the  setup menu (📖 88).
- You can enable and disable daylight saving time by selecting **Time zone and date** and then **Time zone** in the  setup menu. When enabled, the clock moves forward one hour; when disabled, the clock moves back one hour. When the travel destination (➔) is selected, the time difference between the travel destination and the home time zone (🏠) is automatically calculated and the date and time in the selected region are saved at the time of shooting.
- If you exit without setting the date and time, ⌚ will blink when the shooting screen is displayed. Use the **Time zone and date** setting in the setup menu to set the date and time (📖 88).

The Clock Battery

- The camera's clock is powered by a backup battery that is separate from the camera's main battery.
- The backup battery charges when the main battery is inserted into the camera or when the camera is connected to an optional AC adapter, and can provide several days of backup power after about ten hours of charging.
- If the camera's backup battery becomes exhausted, the date and time setting screen is displayed when the camera is turned on. Set the date and time again. See "Setting the Display Language, Date, and Time" step 2 (📖 22) for more information.

Imprinting the Shooting Date in Printed Images

- Set the date and time before shooting.
- You can permanently imprint the shooting date in images as they are captured by setting **Print date** in the setup menu (📖 88).
- If you want the shooting date to be printed without using the **Print date** setting, print using the ViewNX 2 software (📖 75).

Step 2 Select a Shooting Mode

1 Press the button.

- The shooting-mode selection menu which allows you to select the desired shooting mode, is displayed.

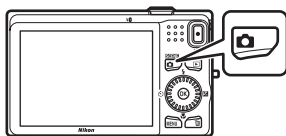

2 Press the multi selector or to select a shooting mode.

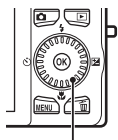

-  (auto) mode is used in this example. Select  **Auto mode**.

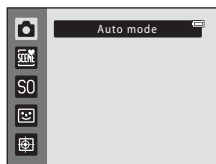

Multi selector







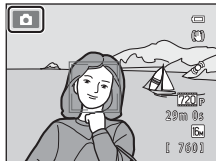

















3 Press the button.







- The camera switches to  (auto) mode and the  icon is displayed.
- See “Shooting Mode” (📖 6) in “The Monitor” for information about the shooting mode screen.
- The shooting mode setting is saved when the camera is turned off.



Available Shooting Modes

	Auto mode	 36
Used for general shooting. Settings can be adjusted in the shooting menu ( 37) to suit the shooting conditions and the type of shot you want to capture.		
	Scene mode	 39
Camera settings are optimized according to the scene that you select. When using scene auto selector, the camera automatically selects the optimum scene mode when you frame a picture, making it even easier to take pictures using settings that suit the scene.		
<ul style="list-style-type: none"> To select a scene, first display the shooting-mode selection menu and then press the multi selector . Select the desired scene by pressing , , , or , and then press the  button. 		
S0	Special effects	 47
Effects can be applied to images during shooting. Six different effects are available.		
<ul style="list-style-type: none"> To select an effect, first display the shooting mode menu and then press the multi selector . Select the desired effect by pressing , , , or , and then press the  button. 		
	Smart portrait	 49
When the camera detects a smiling face, you can take a picture automatically without pressing the shutter-release button (smile timer). You can also use the skin softening option to smooth the skin tones in human faces.		
	Subject tracking	 51
Ideal for focusing on moving subjects.		

Features That Are Available in Shooting Mode

- The multi selector , , , and  can be used to set the corresponding features. See “Features That Can Be Set Using the Multi Selector” ( 55) for more information.
- Press the **MENU** button to display the menu for the selected shooting mode. See “Shooting Features” ( 35) for information about the settings available in the menu for the current shooting mode.

Step 3 Frame a Picture

1 Hold the camera steady.

- Keep fingers, hair, the camera strap, and other objects away from the lens, flash, AF assist-illuminator, microphone, and speaker.
- When taking pictures in portrait (“tall”) orientation, turn the camera so that the flash is above the lens.

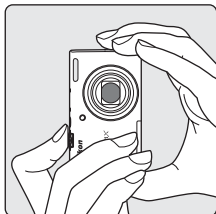
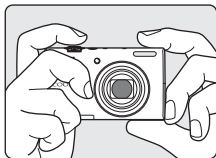

2 Frame the picture.

- When the camera detects a human face, that face is framed by a yellow double border (focus area) (default setting).
- Up to 12 faces can be detected. When the camera detects more than one face, the face closest to the camera is framed by a double border and the others by single borders.
- When shooting non-human subjects or when no faces are detected, the focus area is not displayed. Position the main subject near the center of the frame.

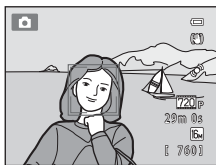

When Using a Tripod

- We recommend using a tripod to stabilize the camera in the following situations.
 - When shooting in dimly lit conditions with the flash mode (📖 57) is set to  (off)
 - When zooming in on the subject
- Set **Vibration reduction to Off** in the setup menu (📖 88) when using a tripod to stabilize the camera during shooting.

Using the Zoom

Use the zoom control to activate optical zoom.

- To zoom in closer to the subject, rotate the zoom control to **T** (telephoto).
- To zoom out and view a larger area, rotate the zoom control to **W** (wide-angle).

When you turn the camera on, the zoom moves to the maximum wide-angle position.

- A zoom indicator is displayed at the top of the monitor when the zoom control is rotated.

Zoom out **W** **T** Zoom in

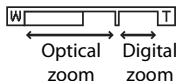
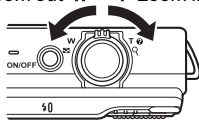

Digital Zoom

When the camera is zoomed in to the maximum optical zoom position, rotating and holding the zoom control at **T** triggers digital zoom.

Digital zoom can magnify the subject up to about 4x beyond the maximum magnification of the optical zoom.

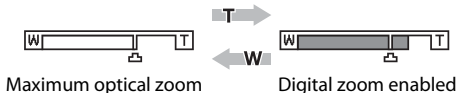



- When you are using digital zoom, the camera focuses on the subject in the center of the frame and the focus area is not displayed.

Digital Zoom and Interpolation

Unlike optical zoom, digital zoom uses a digital imaging process known as interpolation to magnify images, resulting in slight deterioration of picture quality according to the image mode (88) and digital zoom magnification.

Interpolation is applied at zoom positions beyond  when taking still images.

When zoom is increased beyond the  position, interpolation is initiated and the zoom indicator turns yellow to indicate that interpolation is being applied.

The position of  moves to the right as image size decreases, allowing you to confirm the zoom position at which shooting without interpolation is possible at the current image mode setting.



- Digital zoom can be disabled from the **Digital zoom** option in the setup menu (88).

Step 4 Focus and Shoot

1 Press the shutter-release button halfway, i.e., press the button slightly until you feel resistance.

- When you press the shutter-release button halfway, the camera sets the focus and exposure (shutter speed and aperture value). Focus and exposure remain locked while the shutter-release button is pressed halfway.
- When a face is detected:
The camera focuses on the face framed by the double border. When the subject is in focus, the double border glows green.

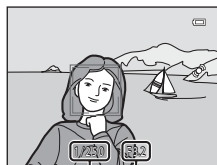
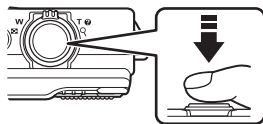

Shutter
speed

Aperture
value

- When a face is not detected:
The camera has nine focus areas, and automatically selects the focus areas containing the subject closest to the camera. When the subject is in focus, the focus areas that are in focus (up to nine areas) glow green.

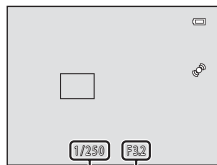

Shutter
speed

Aperture
value

- When you are using digital zoom, the camera focuses on the subject in the center of the frame and the focus area is not displayed. When the camera has focused, the focus indicator (📷 6) glows green.
- While the shutter-release button is pressed halfway, the focus area or focus indicator may blink red. This indicates that the camera is unable to focus. Modify the composition and press the shutter-release button halfway again.

2 Press the shutter-release button the rest of the way down.

- The shutter is released and the image will be saved to the memory card or internal memory.
- If you press the shutter-release button with too much force, the camera may shake, causing images to be blurred. Press the button gently.



✔ Notes About Saving Images

- While images are being saved, the Number of Exposures Remaining (📖 20) will blink. **Do not open the battery-chamber/memory card slot cover** while images are being saved. Removing the battery or memory card in these circumstances could result in loss of data or in damage to the camera or card.
- It may take some time for the image to be saved depending on the current settings or the shooting conditions (🔧:11).

✔ Autofocus

The camera may not focus as expected in the following situations. In some rare cases, the subject may not be in focus despite the fact that the focus area or the focus indicator glows green:

- Subject is very dark
- Objects of sharply differing brightness are included in the scene (e.g. the sun behind the subject makes that subject appear very dark)
- No contrast between the subject and surroundings (e.g. a portrait subject, wearing a white shirt, is standing in front of a white wall)
- Several objects are at different distances from the camera (e.g. the subject is inside a cage)
- Subjects with repeating patterns (window blinds, buildings with multiple rows of similarly shaped windows, etc.)
- Subject is moving rapidly

In the situations noted above, try pressing the shutter-release button halfway to refocus several times, or focus on another subject positioned at the same distance from the camera as the actual desired subject, and use focus lock (📖 70).

✔ Notes About Face Detection

See “Using Face Detection” (📖 67) for more information.

✍ When the Subject Is Close to the Camera

If the camera cannot focus, try shooting with macro mode (📖 59) or the **Close-up** scene mode (📖 43).

✍ AF-assist Illuminator and Flash

If the subject is dimly lit, the AF-assist illuminator (📖 89) may light when the shutter-release button is pressed halfway, and the flash (📖 56) may fire when the shutter-release button is pressed all the way down.

✍ To Make Sure You Do Not Miss a Shot

If you are concerned that you might miss a shot, press the shutter-release button all the way without first pressing it halfway.



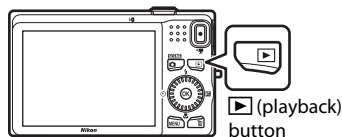

Step 5 Play Back Images

1 Press the (playback) button.

- When you switch from shooting mode to playback mode, the last image saved will be displayed full-frame.



2 Use the multi selector to select an image to display.

- Display the previous image:  or 
- Display the subsequent image:  or 
- You can also scroll through images by rotating the multi selector.



Display the previous image



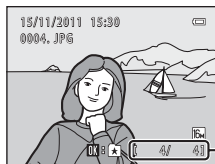

Display the next image





Current image number/
total number of images

- Remove the memory card from the camera to play back images saved in the camera's internal memory.  is displayed near the current image number/total number of images display.
- To return to shooting mode, press the  button, the shutter-release button, or the  (movie-record) button.

Viewing Images

- Images may be displayed briefly at low resolution while being read from the memory card or internal memory.
- When images in which the face of a person ( 67) or a pet ( 46) was detected at the time of shooting are displayed in full-frame playback mode, depending upon the orientation of the detected face, the images may be automatically rotated for playback display (except images captured in a series).
- You can change the orientation of an image using **Rotate image** in the playback menu ( 73).

More Information

- See "Features Available in Playback Mode (Playback Menu)" ( 73) for more information.
- See "Selecting Certain Types of Images for Playback" ( 72) for more information.

Changing How Images Are Displayed

When using playback mode, you can change how images are displayed by rotating the zoom control to **W** (📐) and **T** (🔍).

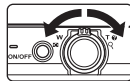

Playback Zoom

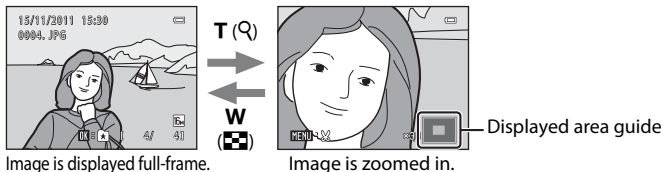
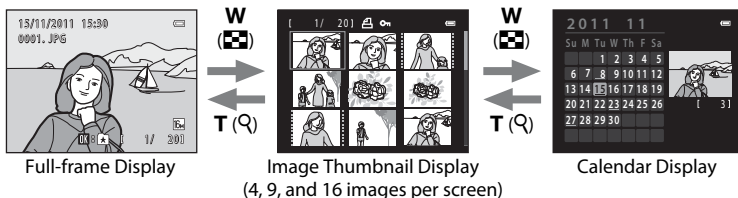

Image is displayed full-frame.

Image is zoomed in.

- You can change the zoom ratio by rotating the zoom control to **W** (📐) and **T** (🔍). Images can be zoomed up to 10x.
- To view a different area of the image, press the multi selector ▲, ▼, ◀, or ▶.
- If you're viewing an image that was captured using face detection (📖 67) or pet detection (📖 46) function, the camera zooms in on the face detected at the time of shooting (except when viewing an image captured in a series). If the camera detected multiple faces when the image was captured, press ▲, ▼, ◀, or ▶ to display a different face. To zoom in on an area of the image where there are no faces, adjust the magnification rate and then press ▲, ▼, ◀, or ▶.
- You can crop the image and save the displayed area of the image as a separate file by pressing the **MENU** button.
- Press the **OK** button to return to full-frame playback mode.

Thumbnail Display, Calendar Display



Full-frame Display

Image Thumbnail Display

Calendar Display



(4, 9, and 16 images per screen)

- You can view several images on one screen, making it easy to find the image you want.
- You can change the number of thumbnails displayed by rotating the zoom control to **W** (📐) and **T** (🔍).
- Rotate the multi selector, or press ▲, ▼, ◀, or ▶ to select an image and then press the **OK** button to display that image full-frame.
- When 16 thumbnails are displayed, rotate the zoom control to **W** (📐) to switch to calendar display.
- While using calendar display mode, rotate the multi selector, or press ▲, ▼, ◀, or ▶ to select a date and then press the **OK** button to display the first image captured on that day.

Step 6 Delete Unwanted Images

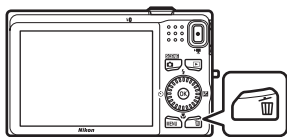
- 1 Press the  button to delete the image currently displayed in the monitor.



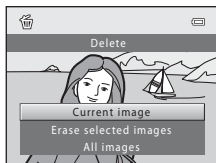

- 2 Press the multi selector  or  to select the desired deletion method and press the  button.

- **Current image:** Only the current image is deleted.
- **Erase selected images:** Multiple images can be selected and deleted. See "Operating the Erase Selected Images Screen" (📖 33) for more information.
- **All images:** All images are deleted.
- To exit without deleting, press the **MENU** button.



- 3 Press  or  to select **Yes** and press the  button.

- Deleted images cannot be recovered.
- To cancel, press  or  to select **No** and press the  button.

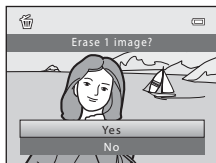

Notes About Deletion

- Deleted images cannot be recovered. Copy important images to a computer before deleting them from the camera.
- Protected images (📖 73) cannot be deleted.

Deleting the Last Image Captured While in Shooting Mode

When using shooting mode, press the  button to delete the last image that was saved.

Operating the Erase Selected Images Screen

- 1** Press the multi selector ◀ or ▶ to select an image to be deleted, and then press ▲ to display ✓.
- To undo the selection, press ▼ to remove ✓.
 - Rotate the zoom control (📖 2) to **T** (🔍) to switch back to full-frame playback or **W** (🖼️) to display thumbnails.



- 2** Add ✓ to all images that you want to delete and then press the **OK** button to confirm the selection.
- A confirmation dialog is displayed. Follow the instructions displayed in the monitor.

Selecting Certain Types of Images for Deletion

When using favorite pictures mode, auto sort mode, or list by date mode (📖 72), you can select images registered as favorites, images in a certain category, or images captured on a specific date for deletion.



A series of horizontal dashed lines spanning the width of the page, intended for handwriting practice. There are 15 lines in total, starting from the top right and extending to the bottom left.

Shooting Features



This chapter describes the camera's shooting modes and the features that are available when using each shooting mode.

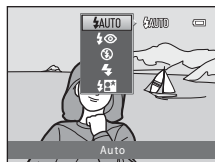
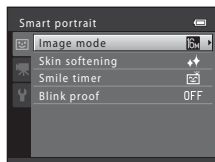
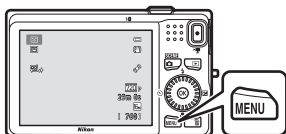
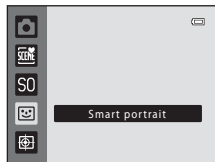
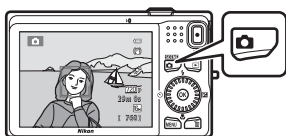

You can select shooting modes and adjust settings according to the shooting conditions and the kind of images you want capture.



(Auto) Mode

Used for general shooting. Settings can be adjusted in the shooting menu ( 37) to suit the shooting conditions and the type of shot you want to capture.







Enter shooting mode →  (shooting mode) button →  (auto) mode ( 24-25)

- You can change how the camera selects the area of the frame to focus on by pressing the **MENU** button, selecting the  tab, and then selecting **AF area mode** ( 37).

The default setting is **Face priority**.

If the camera detects a face, it focuses on that face. See “Using Face Detection” ( 67) for more information. If the camera does not detect a face, it automatically selects the focus areas (up to nine) that contain the subject closest to the camera. When the subject is in focus, the focus areas that are in focus (up to nine areas) glow green.

Changing (Auto) Mode Settings

- Features That Can Be Set Using the Multi Selector ( 55): Flash mode ( 56), self-timer ( 58), macro mode ( 59), and exposure compensation ( 60)
- Features that can be set by pressing the **MENU** button: Options Available in the Auto Shooting Menu ( 37).

Camera Settings That Cannot Be Applied Simultaneously

Some settings cannot be used with other functions ( 65).



Options Available in the Auto Shooting Menu

When using (auto) mode, the following settings can be changed.

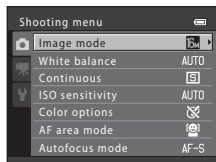
Select (auto) mode → MENU button → tab (📖 10)



Option	Description	📖
Image mode	Allows you to select the combination of image size and image quality used when saving images (📖 63). This setting is also applied to other shooting modes.	63
White balance	Allows you to adjust the color tones of the image to match what you see with your eye. Although Auto (the default setting) can be used in most shooting conditions, if the desired color tones are not achieved, adjust white balance to suit the sky conditions or light source. <ul style="list-style-type: none"> When white balance is set to settings other than Auto or Flash, set the flash mode (📖 56) to (off). 	30
Continuous	Allows you to capture a series of images. When Continuous is selected, up to six images are captured continuously at a rate of about 1.2 fps (when image mode is set to) while the shutter-release button is held all the way down. The default setting is Single (i.e., only one image is captured at a time).	32
ISO sensitivity	Higher ISO sensitivity allows darker subjects to be captured. Additionally, even with subjects of similar brightness, pictures can be taken at faster shutter speeds, and blurring caused by camera shake and subject movement can be reduced. When ISO sensitivity is set to Auto (default setting), the camera sets the ISO sensitivity automatically, and ISO is displayed while shooting when ISO sensitivity increases.	33
Color options	Allows you to change the color tones of images at the time of shooting. The available settings are Standard color (default setting), Vivid color , Black-and-white , Sepia , and Cyanotype .	34
AF area mode	Allows you to determine how the camera selects the focus area that is used for autofocus; the available settings are Face priority (default setting), Auto , Manual , and Center .	35

Option	Description	
Autofocus mode	When Single AF is selected, the camera focuses only while the shutter-release button is pressed halfway. When Full-time AF is selected, the camera focuses even when the shutter-release button is not pressed halfway. You may hear the sound of the camera focusing.	 37

 **Camera Settings That Cannot Be Applied Simultaneously**

Some settings cannot be used with other functions ( 65).

Scene Mode (Shooting Suited to Scenes)

When one of the following scenes is selected, camera settings are automatically optimized for the selected scene.

Enter shooting mode → (shooting mode) button → (second icon from the top*) →
▶ → select a scene (📖 24-25)

* The icon of the last scene selected is displayed. The default setting is (scene auto selector).

Scene auto selector (default setting; 📖 40)	Portrait (📖 40)	Landscape (📖 40)	Sports (📖 41)
Night portrait (📖 41)	Party/indoor (📖 41)	Beach (📖 42)	Snow (📖 42)
Sunset (📖 42)	Dusk/dawn (📖 42)	Night landscape (📖 42)	Close-up (📖 43)
Food (📖 43)	Museum (📖 44)	Fireworks show (📖 44)	Black and white copy (📖 44)
Backlighting (📖 44)	Panorama assist (📖 45)	Pet portrait (📖 46)	

To view a description (help display) of each scene:

Select the desired scene from the scene selection screen and rotate the zoom control (📖 2) to **T** () to view a description of that scene. To return to the original screen, rotate the zoom control to **T** () again.









Changing Scene Mode Settings

- Depending on the scene, the multi selector (), (), (), and () can be used to set the corresponding features. See “Features That Can Be Set Using the Multi Selector” (📖 55) and “Default Settings” (📖 61) for more information.
- Features that can be set by pressing the **MENU** button: Image mode, which is the combination of image size and image quality (📖 63).

Characteristics of Each Scene

Scene auto selector

The camera automatically selects the optimum scene mode when you frame a picture.

: Portrait, : Landscape, : Night portrait, : Night landscape, : Close-up, : Backlighting, : Other scenes

- When the camera selects a scene mode, the shooting mode icon displayed in the shooting screen changes to that for the scene mode currently enabled.
- The area of the frame that the camera focuses on (AF area) depends on the composition of the picture. When the camera detects a human face, it focuses on that face.
- The camera detects and focuses on human faces. See "Using Face Detection" (□□ 67) for more information. Depending upon shooting conditions, the camera may not select the desired scene mode. Should this occur, switch to  (auto) mode (□□ 24) or select the desired scene mode manually.
- Digital zoom cannot be used.

Portrait

Use this mode for portraits.

- When the camera detects a human face, it focuses on that face (□□ 67).
- The camera softens skin tones by applying the skin softening function before saving images (□□ 69).
- If no faces are detected, the camera focuses on the subject in the center of the frame.
- Digital zoom cannot be used.





Landscape

Use this mode for vivid landscapes and cityscapes.

- The focus area or focus indicator (□□ 6) always glows green when the shutter-release button is pressed halfway.



: Use of a tripod is recommended when using scene modes indicated with . Set **Vibration reduction** to **Off** in the setup menu (□□ 88) when using a tripod to stabilize the camera during shooting.

Sports

Use this mode when shooting sporting events. The camera captures a series of still images that allow you to clearly see detailed movements in a moving subject.



- The camera focuses on the area in the center of the frame.
- Press and hold the shutter-release button all the way to capture images continuously. Up to six images are captured continuously at a rate of about 1.2 fps (when image mode is set to )
- The camera focuses even when the shutter-release button is not pressed halfway. You may hear the sound of the camera focusing.
- Focus, exposure, and hue are fixed at the values determined with the first image in each series.
- The frame rate with continuous shooting may vary depending upon the current image mode setting, the memory card used, or shooting condition.



Night portrait



Use this mode for evening and night portraits that include background scenery. The flash fires to light the portrait subject while preserving background lighting to achieve a natural balance between the main subject and background ambience.

- When the camera detects a human face, it focuses on that face ( 67).
- The camera softens skin tones by applying the skin softening function before saving images ( 69).
- If no faces are detected, the camera focuses on the subject in the center of the frame.
- Digital zoom cannot be used.



Party/indoor

Suitable for taking pictures at parties. Captures the effects of candlelight and other indoor background lighting.

- The camera focuses on the area in the center of the frame.
- To avoid the effects of camera shake, hold the camera steady when shooting in dark surroundings. Set **Vibration reduction** to **Off** in the setup menu ( 88) when using a tripod to stabilize the camera during shooting.



Scene Mode (Shooting Suited to Scenes)

Beach

Captures the brightness of such subjects as beaches or sunlit expanses of water.

- The camera focuses on the area in the center of the frame.



Snow

Captures the brightness of sunlit snow.

- The camera focuses on the area in the center of the frame.



Sunset

Preserves the deep hues seen in sunsets and sunrises.

- The camera focuses on the area in the center of the frame.



Dusk/dawn



Preserves the colors seen in the weak natural light before sunrise or after sunset.

- The focus area or focus indicator ( 6) always glows green when the shutter-release button is pressed halfway.





Night landscape

Slow shutter speeds are used to capture stunning night landscapes.







- Use of a tripod is recommended, but when the camera determines whether either a tripod is being used or the camera is hand-held, it changes the shutter-speed appropriately, therefore night-time landscape shooting with reduced blurring is possible even when holding the camera by hand.
- When using a tripod in **Night landscape** mode, there is no need to set **Vibration reduction** in the setup menu ( 88) to Off.
- The focus area or focus indicator ( 6) always glows green when the shutter-release button is pressed halfway.



 Use of a tripod is recommended when using scene modes indicated with . Set **Vibration reduction to Off** in the setup menu ( 88) when using a tripod to stabilize the camera during shooting.

Close-up

Use this mode to photograph flowers, insects, and other small objects at close range.

- Macro mode ( 59) is enabled and the camera automatically zooms to the closest position at which it can focus.
- You can move the area of the frame that the camera focuses on (AF area). To move the AF area, press the  button, and then rotate the multi selector or press , , , or .

To change settings for any of the following functions, first press the  button to cancel focus-area selection, then change the settings as desired.







- Flash mode
- Self-timer
- Exposure compensation
- The camera focuses even when the shutter-release button is not pressed halfway. You may hear the sound of the camera focusing.



Food

Use this mode when taking pictures of food.

- Macro mode ( 59) is enabled and the camera automatically zooms to the closest position at which it can focus.

- You can adjust hue by pressing the multi selector  and . The hue setting is saved in the camera's memory even after the camera is turned off.
- You can move the area of the frame that the camera focuses on (AF area). To move the AF area, press the  button, and then rotate the multi selector or press , , , or .

To change settings for any of the following functions, first press the  button to cancel focus-area selection, then change the settings as desired.

- Hue
- Self-timer
- Exposure compensation
- The camera focuses even when the shutter-release button is not pressed halfway. You may hear the sound of the camera focusing.

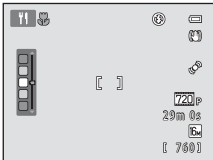

Scene Mode (Shooting Suited to Scenes)

Museum

Use indoors where flash photography is prohibited (for example, in museums and art galleries) or in other settings in which you do not want to use the flash.

- The camera focuses on the area in the center of the frame.
- The camera captures a series of up to ten images while the shutter-release button is held all the way down, and the sharpest image in the series is automatically selected and saved (best shot selector).



Fireworks show



Slow shutter speeds are used to capture the light from fireworks.

- Camera focuses at infinity.
- The focus area or focus indicator ( 6) always glows green when the shutter-release button is pressed halfway.



Black and white copy

Provides clear images of text or drawings on a whiteboard or in print.

- The camera focuses on the area in the center of the frame.
- Use together with macro mode ( 59) when shooting subjects that are close to the camera.

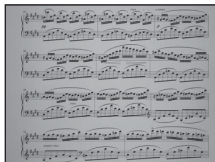



Backlighting

Use when light is coming from behind the subject, throwing features or details into shadow. The flash fires automatically to “fill in” (illuminate) shadows.

- The camera focuses on the area in the center of the frame.











: Use of a tripod is recommended when using scene modes indicated with . Set **Vibration reduction to Off** in the setup menu ( 88) when using a tripod to stabilize the camera during shooting.

Panorama assist



Use this setting to capture a series of images that will be connected using a computer to form a panorama image (2).



- Press the multi selector , ,  or  to select the direction that you will move the camera in when capturing images, and press the  button.
- After shooting the first image, confirm on the screen how the captured image will be connected to the next image, and shoot the next image. Shoot as many images as needed to complete the panorama. To finish shooting, press the  button.
- Transfer the images to your computer and use the included Panorama Maker 5 ( 76, 3) software to combine the images into a single panorama image.

Pet portrait

Use this mode when taking pictures of dogs or cats. When the camera detects the face of a dog or cat, the camera focuses on that face. Once the camera has focused, by default it automatically releases the shutter (pet portrait auto release).







- From the screen displayed after the  **Pet portrait** scene mode is selected, select **Single** or **Continuous**.

- **Single:** Images are captured one at a time.
- **Continuous:** Three images are captured continuously when a face is focused on (at a rate of about 1.2 fps when image mode is  **4608x3456**). While **Continuous** is selected, the  is displayed in the shooting screen.

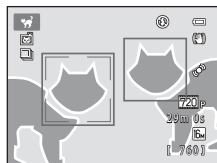
- When the camera detects a face, a double border (focus area) is displayed around the face, and the double border glows green when the camera has focused.



The faces of up to five pets can be detected at the same time. When the camera detects more than one face, the face displayed largest in the monitor is framed by a double border and the others by single borders.



- If no pet faces are detected, the shutter can be released by pressing the shutter-release button.
 - If no pet faces are detected, the camera focuses on the subject at the center of the frame.
 - When **Continuous** is selected, up to three images are captured continuously at a rate of about 1.2 fps (when image mode is set to  **4608x3456**) while the shutter-release button is held all the way down.
- Press the multi selector  to change auto release settings.
 - **Pet portrait auto release** (default setting): The camera automatically releases the shutter when it focuses on the detected face. While **Pet portrait auto release** is selected, the  icon is displayed in the shooting screen.
 - **Off:** The shutter is released only when the shutter-release button is pressed.
- Digital zoom cannot be used.
- Depending on the distance of the pet from the camera, the speed of the pet's movement, the direction the pet is facing, the ambient brightness of the pet's face, etc., pet faces may not be detected and other subjects may be displayed with a border.
- **Pet portrait auto release** is automatically set to **Off** in the following situations.
 - When five series of images are captured using auto release
 - When there is no remaining space in the internal memory or on the memory card
 To continue using **Pet portrait auto release** to take more pictures, press the multi selector  and change the setting again.

Special Effects Mode (Applying Effects When Shooting)



Effects can be applied to images during shooting.



Enter shooting mode →  (shooting mode) button → SO (third icon from the top*) →  select an effect ( 24-25)

* The icon of the last effect selected is displayed. The default setting is SO (soft).





The following six effects are available.



Category	Description
SO Soft (default setting)	Softens the image by adding a slight blur to the entire image.
SE Nostalgic sepia	Adds a sepia tone and reduces the contrast to simulate the qualities of an old photograph.
 High-contrast monochrome	Changes the image to black and white and gives it sharp contrast.
HI High key	Gives the entire image a bright tone.
LO Low key	Gives the entire image a dark tone.
 Selective color	Creates a black and white image in which only the specified color remains.

- The camera focuses on the area in the center of the frame.
- When **Selective color** is selected, rotate the multi selector or press  or  to select the desired color from the slider.

To change settings for any of the following functions, first press the  button to cancel color selection, then change the settings as desired.

- Flash mode ( 56)
- Self-timer ( 58)
- Macro mode ( 59)
- Exposure compensation ( 60)

To return to the color selection screen, press the  button again.

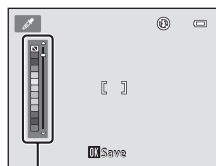

Slider





Changing Special Effects Mode Settings

- Features That Can Be Set Using the Multi Selector (📖 55): Flash mode (📖 56), self-timer (📖 58), macro mode (📖 59), and exposure compensation (📖 60)
- Features that can be set by pressing the **MENU** button: Image mode, which is the combination of image size and image quality (📖 63).

Smart Portrait Mode (Shooting Smiling Faces)

When the camera detects a smiling face, you can take a picture automatically without pressing the shutter-release button (smile timer). You can use the skin softening option to smooth the skin tones in human faces.

Enter shooting mode →  (shooting mode) button →  Smart portrait mode (📖 24-25)

1 Without pressing the shutter-release button, frame the picture and wait for the subject to smile.

- When the camera detects a human face, a yellow double border (focus area) is displayed around that face. When the camera has focused on that face, the double border will turn green for a moment and focus is locked.
- Up to three faces can be detected. When the camera detects more than one face, a double border is displayed around the face closest to the center of the frame, and single borders are displayed around the other faces.
- If the camera detects that the face framed by the double border is smiling, the **Smile timer** (📖 50) feature is activated and the shutter is automatically released.
- After the camera releases the shutter, it will continue to detect faces and smiles, and will release the shutter again if it detects a smiling face.

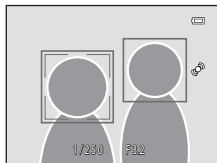

2 Shooting ends.

- Any one of the following operations can be used to cancel smile detection and stop shooting.
 - Turn the camera off.
 - Set **Smile timer** (📖 50) to **Off**.
 - Press the  button and select a different shooting mode.

Notes About Smart Portrait Mode

- Digital zoom cannot be used.
- Under some shooting conditions, the camera may be unable to detect faces or detect smiles.
- See “Notes About Face Detection” (📖 67) for more information.

Auto Power Off in Smile Timer Mode

When **Smile timer** is set to **On**, the auto power off function (📖 89) is activated and the camera turns off when either of the situations indicated below persists and no other operations are performed.

- The camera does not detect any faces.
- The camera detected a face, but cannot detect a smile.

When the Self-timer Lamp Blinks

When using smile timer, the self-timer lamp blinks when the camera detects a face and flickers immediately after the shutter is released.

Releasing the Shutter Manually

The shutter can also be released by pressing the shutter-release button. If no faces are detected, the camera focuses on the subject at the center of the frame.

Changing Smart Portrait Mode Settings

- Features That Can Be Set Using the Multi Selector (📖 55): Flash mode (📖 56), self-timer (📖 58), and exposure compensation (📖 60)
- Features that can be set by pressing the **MENU** button: Options available in the smart portrait menu.

Camera Settings That Cannot Be Applied Simultaneously





Some settings cannot be used with other functions (📖 65).

Options Available in the Smart Portrait Menu

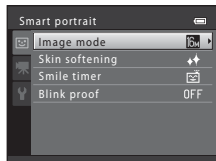
When using  smart portrait mode, the following settings can be changed.

Select smart portrait mode → **MENU** button →  tab (📖 10)





Option	Description	
Image mode	Allows you to select the combination of image size and image quality used when saving images (📖 63). If you change the image mode setting, the new setting is applied to all shooting modes.	63
Skin softening	Enable skin softening. The camera softens skin tones by applying the skin softening function before saving images. You can select the amount of effect that is applied. The default setting is Normal .	 38
Smile timer	When On (default setting) is selected, the camera detects human faces and then automatically releases the shutter whenever a smile is detected. Self-timer cannot be used with this feature.	 38
Blink proof	When On is selected, the camera automatically releases the shutter twice each time a picture is taken. Of the two shots, one in which the subject's eyes are open is saved. The flash cannot be used when On is selected. The default setting is Off .	 39

Camera Settings That Cannot Be Applied Simultaneously

Some settings cannot be used with other functions (📖 65).

Subject Tracking Mode (Focusing on a Moving Subject)

Use this mode to focus on a subject that is moving when taking pictures.

Enter shooting mode →  (shooting mode) button →  Subject tracking mode (📖 24-25)

When you register a subject, subject tracking begins and the focus area automatically follows the subject.

1 Register a subject.

- When taking pictures of people:

Face priority tracking (📖 53) can be used to detect a human face and then automatically register that person as the subject to be tracked.

If the subject is not registered automatically, align the subject that you want to register with the white border in the center of the monitor and press the **OK** button.

- When taking pictures of non-human subjects:

Align the subject that you want to register with the white border in the center of the monitor and press the **OK** button.

If a person visible in the frame was automatically registered, set **Face priority tracking** to **Off** and register the desired subject again.

- When the camera is unable to focus on the subject, the border will glow red. Change the composition and try registering the subject again.
- When the subject is registered, a yellow border (focus area) is displayed around that subject and the camera begins tracking that subject.
- To cancel subject registration, press the **OK** button.
- If the camera cannot track the registered subject anymore, the focus area will disappear and the registration will be canceled. Register the subject again.

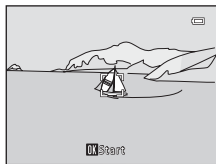
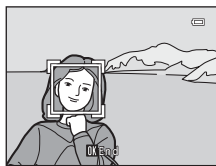

2 Press the shutter-release button to take a picture.

- The camera focuses on the focus area when the shutter release button is pressed halfway. The focus area will glow green and focus will be locked.
- Press the shutter-release button all the way down to release the shutter.

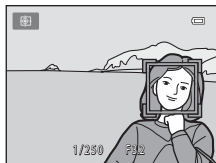





Subject Tracking Mode (Focusing on a Moving Subject)

Notes About Subject Tracking Mode

- Adjust zoom position, flash mode, exposure compensation, and menu settings prior to registering the subject.
- Subject tracking may not be possible in certain shooting conditions.
- Digital zoom cannot be used.

Changing Subject Tracking Mode Settings

- Features That Can Be Set Using the Multi Selector ( 55): Flash mode ( 56), exposure compensation ( 60)
- Features that can be set by pressing the **MENU** button: Options available in the subject tracking menu ( 53).

Camera Settings That Cannot Be Applied Simultaneously





Some settings cannot be used with other functions ( 65).

Options Available in the Subject Tracking Menu

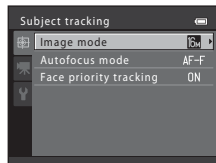

When using  subject tracking mode, the following settings can be changed.

Select subject tracking mode → MENU button →  tab (📖 10)



Option	Description	
Image mode	Allows you to select the combination of image size and image quality used when saving images (📖 63). If you change the image mode setting, the new setting is applied to all shooting modes.	63
Autofocus mode	Set Autofocus mode (📖 38) used for subject tracking mode. When Full-time AF (default setting) is selected, once a subject is registered for subject tracking, the camera continuously focuses until the shutter-release button is pressed halfway to lock the focus. The sound of the lens drive will be heard while the camera focuses. Changes made to the autofocus mode setting in this mode will not be applied to the autofocus mode setting in  (auto) mode. The autofocus mode setting applied in subject tracking mode is saved in the camera's memory even after the camera is turned off.	 40
Face priority tracking	When On is selected (default setting), if the camera detects a person's face, that person is automatically registered as the subject to be tracked, and subject tracking begins tracking that person. If a person whom you do not want to track is automatically registered, or when shooting non-human subjects, select Off if a person is in the frame.	 40

Notes About Face Priority Tracking

- Only one subject can be tracked. If the camera detects multiple faces at the same time, the face closest to the center of the frame is tracked.
- When the frame includes more than one face, the face detected by the camera and registered as the subject to be tracked depends upon a variety of factors, including the direction in which the faces are looking.
- Depending on shooting conditions, such as whether or not the subject is facing the camera, the face may not be detected properly. Additionally, the camera may be unable to detect faces in the following situations:
 - When faces are partially hidden by sunglasses or otherwise obstructed
 - When faces take up too much or too little of the frame
- When the camera is unable to track the registered subject, press the  button to track again, or set **Face priority tracking** to **Off**, frame the picture so that the subject is inside the border in the center of the frame, and press the  button to register the subject again.

Camera Settings That Cannot Be Applied Simultaneously

Some settings cannot be used with other functions ( 65).

Features That Can Be Set Using the Multi Selector

When shooting, the multi selector ▲ (⚡), ▼ (🌸), ◀ (🕒), and ▶ (📷) can be used to set the following features.

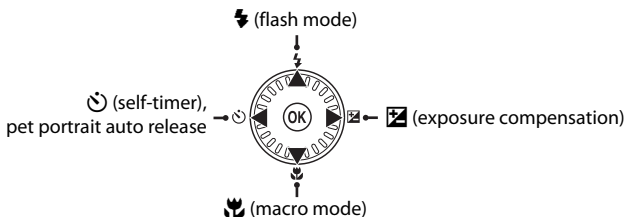

Available Features

The features that are available vary with the shooting mode, as shown below.

- See “Default Settings” (📖 61) for information about each mode’s default settings.

	📷 (auto)	Scene	Special Effects	Smart Portrait Mode	Subject Tracking Mode
⚡ Flash mode (📖 56)	✓	1	✓	✓ ²	✓
🕒 Self-timer (📖 58)	✓		✓	✓ ²	–
🕒 Pet portrait auto release (📖 46)	–		–	–	–
🌸 Macro (📖 59)	✓		✓	–	–
📷 Exposure compensation (📖 60)	✓		✓	✓	✓

¹ Varies by the scene. See “Default Settings” (📖 61) for more information.

² Varies by the smart portrait menu setting. See “Default Settings” (📖 61) for more information.

Using the Flash (Flash Modes)

You can set the flash mode to match the shooting conditions.

- 1 Press the multi selector ▲ (⚡ flash mode).



- 2 Use the multi selector to select the desired mode and press the OK button.

- See “Available Flash Modes” (📖 57) for more information.
- If a setting is not applied by pressing the OK button within a few seconds, the selection will be canceled.
- When ⚡AUTO (auto) is applied, ⚡AUTO is only displayed for a few seconds, regardless of **Monitor settings** settings (📖 88).

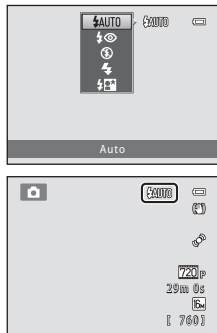

- 3 Frame the subject and take a picture.



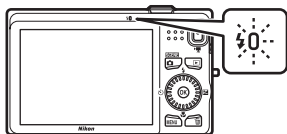

- The flash lamp indicates the status of the flash when you press the shutter-release button halfway.
 - On: The flash will fire when you press the shutter-release button all the way down.
 - Blinking: The flash is charging. The camera cannot take pictures.
 - Off: The flash will not fire when a picture is taken.
- If the battery is low, the monitor will turn off in order to save power while the flash is charging.



Effective Range of the Flash

When ISO sensitivity is set to **Auto**, the flash has a range of 0.5 to 4.6 m (1 ft 8 in. to 15 ft) at the maximum wide-angle zoom position and a range of 0.5 to 3.0 m (1 ft 8 in. to 9 ft 10 in.) at the maximum telephoto zoom position.

Available Flash Modes

 AUTO	Auto
	The flash fires automatically when lighting is dim.
 Auto with red-eye reduction	Auto with red-eye reduction
	Reduce red-eye in portraits caused by the flash.
 Off	Off
	The flash will not fire. We recommend using a tripod to stabilize the camera when shooting in dark surroundings.
 Fill flash	Fill flash
	The flash fires whenever a picture is taken. Use to “fill-in” (illuminate) shadows and backlit subjects.
 Slow sync	Slow sync
	Auto flash mode is combined with slow shutter speed. Suited to evening and night portraits that include background scenery. The flash illuminates main subject; slow shutter speeds are used to capture background at night or under dim lighting.

The Flash Mode Setting

- The setting varies with the shooting mode. See “Available Features” (📖 55) and “Default Settings” (📖 61) for more information.
- Some settings cannot be used with other functions (📖 65).
- The flash mode setting applied in  (auto) mode is saved in the camera’s memory even after the camera is turned off.

Red-eye Reduction

This camera uses **Advanced Red-Eye Reduction** (In-Camera Red-Eye Fix).

If the camera detects red eye while saving an image, the affected area will be processed to reduce red-eye before the image is saved.

Note the following when shooting:

- More time than usual is required to save images.
- Red-eye reduction may not produce the desired results in all situations.
- In some cases, red-eye correction may be applied to areas of an image unnecessarily. In these cases, select another flash mode and take the picture again.

Using the Self-timer

The camera is equipped with a self-timer that releases the shutter ten seconds or two seconds after you press the shutter-release button. The self-timer is useful when you want to be in the picture you are taking, and when you want to avoid the effects of camera shake that occur when you press the shutter-release button. When using the self-timer, use of a tripod is recommended. Set **Vibration reduction to Off** in the setup menu (📖 88) when using a tripod to stabilize the camera during shooting.

1 Press the multi selector ◀ (🕒 self-timer).



2 Use the multi selector to select **10s** or **2s** and press the **OK** button.

- **10s** (ten seconds): Use on important occasions, such as weddings.
- **2s** (two seconds): Use to prevent camera shake.
- When the shooting mode is the **Pet portrait** scene mode, 📷 (Pet portrait auto release) is displayed (📖 46). The self-timer settings **10s** and **2s** cannot be used.
- The mode selected for self-timer is displayed.
- If a setting is not applied by pressing the **OK** button within a few seconds, the selection will be canceled.

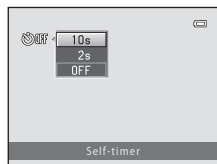

3 Frame the picture and press the shutter-release button halfway.

- Focus and exposure will be set.



4 Press the shutter-release button the rest of the way down.

- The self-timer starts, and the number of seconds remaining before the shutter is released is displayed in the monitor. The self-timer lamp blinks while the timer is counting down. About one second before the shutter is released, the lamp stops blinking and glows steadily.
- When the shutter is released, the self-timer will be set to **OFF**.
- To stop the timer before a picture is taken, press the shutter-release button again.

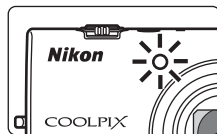
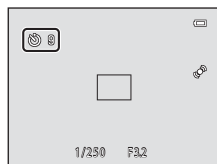

Using Macro Mode

When using macro mode, the camera can focus on objects as close as 10 cm (4 in.) from the front of the lens.

This feature is useful when taking close-up pictures of flowers and other small subjects.

- 1** Press the multi selector ▼ (👉 macro mode).



- 2** Use the multi selector to select **ON** and press the **OK** button.

- The macro mode icon (👉) is displayed.
- If a setting is not applied by pressing the **OK** button within a few seconds, the selection will be canceled.

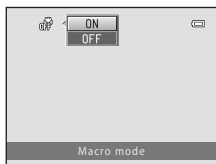

- 3** Use the zoom control to set the zoom ratio to a position where 👉 and the zoom indicator glow green.



- How close you can be to the subject when shooting depends on the zoom ratio. When the zoom ratio is set to a position where 👉 and the zoom indicator glow green, the camera can focus on subjects as close as 30 cm (1 ft) from the lens. When the zoom is at the maximum wide-angle position, (at the position where 🌄 is displayed), the camera can focus on subjects as close as 10 cm (4 in.) from the lens.

✓ Notes About Using the Flash

The flash may be unable to light the entire subject at distances of less than 50 cm (1 ft 8 in.).

📎 Autofocus

When using macro mode in the 📷 (auto) mode, you can focus without pressing the shutter-release button halfway by setting **Autofocus mode** (📖 38) in the shooting menu (📖 37) to **Full-time AF**.

When using other shooting modes, **Full-time AF** is turned on automatically when macro mode is turned on (except when using the **Pet portrait** scene mode).

You may hear the sound of the camera focusing.

📎 The Macro Mode Setting

- Macro mode cannot be used when using certain shooting modes. See "Default Settings" (📖 61) for more information.
- The macro mode setting applied in 📷 (auto) mode is saved in the camera's memory even after the camera is turned off, and reapplied the next time 📷 (auto) mode is selected.

Adjusting Brightness (Exposure Compensation)

By adjusting exposure compensation when taking pictures, you can adjust overall image brightness.

- 1 Press the multi selector ► (☒ exposure compensation).

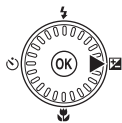

- 2 Use the multi selector to select a compensation value.

- To make the image brighter, apply positive (+) exposure compensation.
- To make the image darker, apply negative (-) exposure compensation.

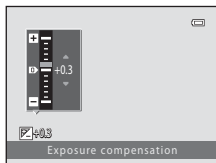

- 3 Press the **OK** button to apply the compensation value.

- If you do not press the **OK** button within a few seconds, the setting will be applied and the menu will disappear.
- When an exposure compensation value other than **0.0** is applied, the value is displayed with the ☒ indicator in the monitor.

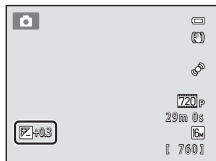

- 4 Press the shutter-release button to take a picture.

- To turn off exposure compensation, return to step 1 and change the value to **0.0**.









Exposure Compensation Value

The exposure compensation value applied in  (auto) mode is saved in the camera's memory even after the camera is turned off.

Default Settings

Default settings for each shooting mode are described below.

- Information about scene mode can be found on the next page.

	Flash ( 56)	Self-timer ( 58)	Macro ( 59)	Exposure compensation ( 60)
 (auto)	 AUTO	Off	Off	0.0
Special effects	 \$	Off	Off	0.0
Smart portrait	 AUTO ¹	Off ²	Off ³	0.0
Subject tracking	 AUTO	Off ³	Off ³	0.0

¹ Cannot be used when **Blink proof** is set to **On**.

² Can be set when **Smile timer** is set to **Off**.

³ The setting cannot be changed.

- The setting applied in  (auto) mode is saved in the camera's memory even after the camera is turned off except for the self-timer setting.

Features That Can Be Set Using the Multi Selector

Default settings for scene mode are described below.

	Flash (📖 56)	Self-timer (📖 58)	Macro (📖 59)	Exposure compensation (📖 60)
(📖 40)	⚡AUTO ¹	Off	Off ²	0.0
(📖 40)	👁️	Off	Off ²	0.0
(📖 40)	🌞 ²	Off	Off ²	0.0
(📖 41)	🌞 ²	Off ²	Off ²	0.0
(📖 41)	👁️ ³	Off	Off ²	0.0
(📖 41)	👁️ ⁴	Off	Off ²	0.0
(📖 42)	⚡AUTO	Off	Off ²	0.0
(📖 42)	⚡AUTO	Off	Off ²	0.0
(📖 42)	🌞 ²	Off	Off ²	0.0
(📖 42)	🌞 ²	Off	Off ²	0.0
(📖 42)	🌞 ²	Off	Off ²	0.0
(📖 43)	🌞 ²	Off	On ²	0.0
(📖 43)	🌞 ²	Off	On ²	0.0
(📖 44)	🌞 ²	Off	Off	0.0
(📖 44)	🌞 ²	Off ²	Off ²	0.0 ²
(📖 44)	🌞	Off	Off	0.0
(📖 44)	🌞 ²	Off	Off ²	0.0
(📖 45)	🌞	Off	Off	0.0
(📖 46)	🌞 ²	📷 ⁵	Off	0.0

¹ ⚡AUTO (auto) and 🌞 (off) can be selected. When ⚡AUTO (auto) is selected, the camera automatically selects the flash mode appropriate for the scene it has selected.

² The setting cannot be changed.

³ The setting cannot be changed. The flash mode setting is fixed at fill flash with slow sync and red-eye reduction.

⁴ Slow sync with red-eye reduction flash mode may be used.

⁵ Self-timer cannot be used. Pet portrait auto release can be set to On or Off (📖 46).

🗒️ Camera Settings That Cannot Be Applied Simultaneously















Some settings cannot be used with other functions (📖 65).

Changing the Image Size (Image Mode)

Enter shooting mode → MENU button → Shooting menu → Image mode

You can use the **Image mode** setting in the shooting menu to select the combination of image size and compression ratio that is used when saving images. Select the image mode best suited to the manner in which images will be used and the capacity of the internal memory or memory card. The higher the image mode setting, the larger the size at which it can be printed, but the number of images that can be saved is reduced.

Image Mode Settings (Image Size and Quality)

Image mode*	Description
 4608×3456★	Images will be higher quality than  . The compression ratio is approximately 1:4.
 4608×3456 (default setting)	
 4000×3000	Best choice in most situations. The compression ratio is approximately 1:8.
 3264×2448	
 2592×1944	
 2048×1536	Smaller size than  ,  ,  , or  and therefore allows more images to be saved. The compression ratio is approximately 1:8.
 1024×768	Suited to display on a computer monitor. The compression ratio is approximately 1:8.
 640×480	Suited to full-screen display on a TV with an aspect ratio of 4:3, or distribution by e-mail. The compression ratio is approximately 1:8.
 4608×2592	Images with an aspect ratio of 16:9 are saved. The compression ratio is approximately 1:8.

* The total number of pixels captured, and the number of pixels captured horizontally and vertically.

Example:  **4608×3456** = approx. 16 megapixels, 4608 × 3456 pixels

The icon for the current setting is displayed in the monitor in shooting and playback modes (📖 6, 7).









Notes About Image Mode

- The setting is also applied to other shooting modes.
- Some settings cannot be used with other functions (📖 65).

Changing the Image Size (Image Mode)

Number of Images That Can Be Saved

The following table lists the approximate number of images that can be saved in the internal memory and on a 4 GB memory card. Note that due to JPEG compression, the number of images that can be saved varies greatly depending on the composition of the image. In addition, this number may vary depending on the make of the memory card, even when the memory cards have the same specified capacity.

Image mode	Internal memory (approx. 74 MB)	Memory card ¹ (4 GB)	Print size ² (cm/in.)
 4608×3456★	7	380	39 × 29/15 × 11.5
 4608×3456	14	760	39 × 29/15 × 11.5
 4000×3000	18	1000	34 × 25/13 × 10
 3264×2448	29	1570	28 × 21/11 × 8
 2592×1944	47	2560	22 × 16/8.5 × 6.5
 2048×1536	79	4230	17 × 13/7 × 5
 1024×768	229	12700	9 × 7/3.5 × 2.5
 640×480	445	24600	5 × 4/2 × 1.5
 4608×2592	18	1010	39 × 22/15 × 8.5

¹ If the number of exposures remaining is 10,000 or more, the number of exposures remaining display shows “9999”.

² Print size at an output resolution of 300 dpi. Print sizes are calculated by dividing the number of pixels by printer resolution (dpi) and multiplying by 2.54 cm (1 in.). However, at the same image size, images printed at higher resolutions will print smaller than the size indicated, and those printed at lower resolutions will print larger than the size indicated.

Features That Cannot Be Used Simultaneously

Some shooting settings cannot be used with other functions.

Restricted function	Option	Descriptions
Flash mode	Continuous (📖 37)	When Continuous , BSS , or Multi-shot 16 is selected, the flash cannot be used.
	Blink proof (📖 50)	When Blink proof is set to On , the flash cannot be used.
Self-timer	Smile timer (📖 50)	When Smile timer is used for shooting, the self-timer cannot be used.
Image mode	Continuous (📖 37)	When Multi-shot 16 is selected, the Image mode setting is fixed at 5 (image size: 2560 × 1920 pixels).
White balance	Color options (📖 37)	When using Black-and-white , Sepia , or Cyanotype , the White balance setting is fixed at Auto .
Continuous	Self-timer (📖 58)	When using the self-timer, Continuous is fixed at Single .
ISO sensitivity	Continuous (📖 37)	When Multi-shot 16 is selected, the ISO sensitivity setting is automatically specified according to the brightness.
Motion detection	Continuous (📖 37)	When Multi-shot 16 is selected, Motion detection is disabled.
	ISO sensitivity (📖 37)	When the ISO sensitivity is set to any setting other than Auto , Motion detection is disabled.
Blink warning	Continuous (📖 37)	When Continuous , BSS , or Multi-shot 16 is selected, Blink warning is disabled.
Digital zoom	Continuous (📖 37)	When Multi-shot 16 is selected, digital zoom cannot be used.

Features That Cannot Be Used Simultaneously

Restricted function	Option	Descriptions
Shutter sound	Continuous (📖 37)	When Continuous , BSS , or Multi-shot 16 is selected, the shutter sound is not heard.

Notes About Digital Zoom

- Depending on the shooting mode or the current settings, digital zoom may not be available (📷63).
- When digital zoom is in effect, the camera focuses in the center of the frame.

Using Face Detection

In the following shooting modes, the camera uses face detection to automatically focus on human faces. If the camera detects more than one face, a double border is displayed around the face that the camera will focus on, and single borders are displayed around the other faces.



Shooting mode	Number of faces that can be detected	Focus area (double border)
When AF area mode (📖 37) in 📷 (auto) mode is set to Face priority .	Up to 12	The face closest to the camera
Scene auto selector , Portrait , Night portrait scene mode (📖 39) is selected		
Smart portrait mode (📖 49)	Up to 3	The face closest to the center of the frame

* For more information about face detection while using subject tracking mode, see “Subject Tracking Mode (Focusing on a Moving Subject)” (📖 51).

- When using **📷 (auto)** mode, if you press the shutter-release button halfway while no faces are detected or while framing a shot with no faces in it, the camera selects the focus area (up to nine areas) containing the subject closest to the camera.
- When **Scene auto selector** is selected, the focus area changes depending on which scene the camera selects.
- If no faces are detected when the shutter-release button is pressed halfway in **Portrait** and **Night portrait** scene modes or in smart portrait mode, the camera will focus on the subject in the center of the frame.

📌 Notes About Face Detection

- The camera’s ability to detect faces depends on a variety of factors, including whether or not the subject is facing the camera. Additionally, the camera may be unable to detect faces in the following situations:
 - When faces are partially hidden by sunglasses or otherwise obstructed
 - When faces take up too much or too little of the frame
- When the frame includes more than one face, the faces detected by the camera and the face on which the camera focuses depend upon a variety of factors, including the direction in which the faces are looking.
- In some rare cases, such as those described in “Autofocus” (📖 29), the subject may not be in focus even though the double border turns green. If the camera does not focus, change AF area mode to **Manual** or **Center** in **📷 (auto)** mode, and try focus lock shooting (📖 70) by focusing on another subject that is the same distance from the camera.

Viewing Images That Were Captured Using Face Detection

- During playback, the camera automatically rotates images according to the orientation of the faces that were detected at the time of shooting (except when viewing an image captured in a series).
- When zooming in on an image displayed full-frame by rotating the zoom control to **T** (📷), the image will be enlarged so that the face that was detected at the time of shooting is displayed in the center of the monitor (📖 31; except when viewing an image captured in a series).

Using Skin Softening

When the shutter is released when using one of the following shooting modes, the camera detects one or more human faces (up to three), and processes the image to soften facial skin tones before saving the image.

- **Scene auto selector** (📖 40), **Portrait** (📖 40), or **Night portrait** (📖 41) scene mode is selected.
- Smart portrait mode (📖 49)

Skin softening can also be applied to saved images (📖 73).

✓ Notes About Skin Softening

- It may take more time than usual to save images after shooting.
- Under some shooting conditions, the desired skin softening results may not be achieved, and skin softening may be applied to areas of the image where there are no faces. If the desired results are not produced, switch to another shooting mode and then try shooting again.
- The skin softening level cannot be adjusted when **Portrait** or **Night portrait** is selected in scene mode.

Focus Lock

You can use focus lock to focus on off-center subjects when center is selected for AF area mode.

The following procedure describes how to use focus lock when using  (auto) mode with **AF area mode** ( 37) set to **Center**.

1 Position the subject in the center of the frame.

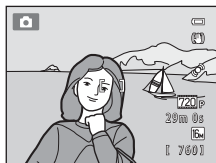

2 Press the shutter-release button halfway.

- Confirm that the focus area glows green.
- Focus and exposure are locked.



3 Continue holding down the shutter-release button halfway and recompose the picture.

- Be sure to maintain the same distance between the camera and the subject while the shutter-release button is pressed halfway.

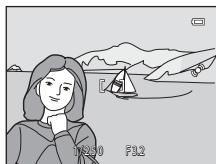

4 Press the shutter-release button the rest of the way down to take the picture.



Playback Features

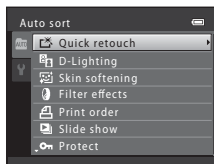
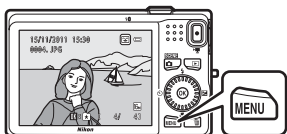
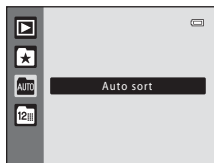
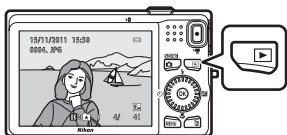

This chapter describes how to select certain types of images for playback as well as some of the features available when playing back images.



Selecting Certain Types of Images for Playback

You can change the playback mode according to the type of images you want to view.

Available Playback Modes

 **Play**  30

All images are played back. When you switch from shooting mode to playback mode, this mode is selected.

 **Favorite pictures**  4

Play back images added to an album. You must add images to an album before you can select this mode ( 9).

 **Auto sort**  7

Images are automatically sorted in to categories, such as portraits, landscapes, and movies.

 **List by date**  9

Images captured on the selected date are played back.

Switching Between Playback Modes

1 When viewing images in full-frame playback mode or thumbnail playback mode, press the  button.

- The playback-mode selection menu is displayed, from which you can select one of the available playback modes.

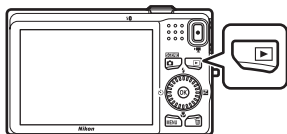





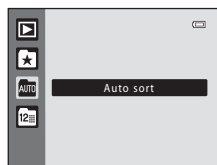

2 Use the multi selector to select the desired mode and press the  button.

- If you select **Play**, the playback screen is displayed.
- When an option other than **Play** is selected, the album, category, or shooting date selection screen is displayed.
- To return to the current playback mode without switching playback modes, press the  button.























3 Select an album, category, or shooting date, and press the  button.

-  For favorite pictures, see  4.
-  For auto sort, see  7.
-  For list by date, see  9.
- Repeat from step 1 to select a different album, category, or shooting date.

Features Available in Playback Mode (Playback Menu)

When viewing images in full-frame playback mode or thumbnail playback mode, you can configure the following functions by pressing the **MENU** button (📖 10) to display the menu, and then selecting the  tab,  tab,  tab, or  tab.

Option	Description	
 Quick retouch ¹	Allows you to create retouched copies in which contrast and saturation have been enhanced.	 12
 D-Lighting ¹	Allows you to create copies with enhanced brightness and contrast, brightening dark portions of an image.	 13
 Skin softening ¹	When this feature is enabled, the camera detects faces in images and creates a copy with softer facial skin tones.	 14
 Filter effects ¹	Digital filter effects can be used to apply a variety of effects to images. Effect types include Soft , Selective color , Cross screen , Fisheye , Miniature effect , and Painting .	 16
 Print order ²	When using a printer to print images saved on the memory card, you can use the Print order function to select which images are printed, and how many copies of each image are printed.	 41
 Slide show ²	Allows you to view images saved in the internal memory or on a memory card in an automatic slide show.	 45
 Protect ²	Protects selected images from accidental deletion.	 46
 Rotate image	Specifies the orientation in which saved images are displayed with playback.	 48
 Small picture ¹	Creates a small copy of the current image. This feature is useful for creating copies for display on Web pages or e-mail attachments.	 18
 Voice memo	Allows you to use the camera's microphone to record voice memos and attach them to images. You can also play back and delete voice memos.	 49
 Copy ³	Allows you to copy images between the internal memory and a memory card.	 51

¹ Images are edited and saved as separate files. Certain restrictions apply ( 10,  11). For example, images captured at an **Image mode** (📖 63) setting of  **4608x2592** cannot be edited, and the same editing feature cannot be applied multiple times.

² When using list by date mode, press the **MENU** button from the list of dates screen ( 9) to apply the same function to all images captured on the selected date.

³ This function is not displayed when using favorite pictures mode, auto sort mode, or list by date mode.

Connecting the Camera to a TV, Computer, or Printer

You can enhance your enjoyment of images and movies by connecting the camera to a TV, computer, or printer.

- Before connecting the camera to an external device, make sure the remaining battery level is sufficient and turn the camera off. For information about the connection methods and subsequent operations, refer to the documentation included with the device in addition to this document.

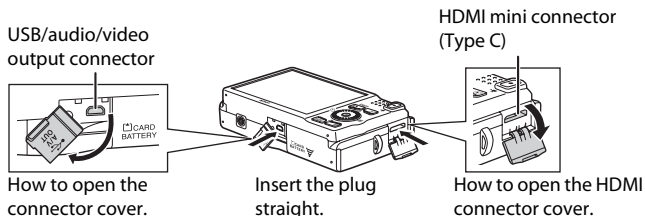

Viewing images on a TV



You can view the camera's images and movies on a TV.

Connection method: Connect the video and audio plugs of the included Audio Video Cable EG-CP16 to the TV's input jacks. Alternatively, connect a commercially available HDMI cable (Type C) to the TV's HDMI input jack.

Viewing and organizing images on a computer



If you transfer images to a computer, you can perform simple retouching and manage image data in addition to playing back images and movies.

Connection method: Connect the camera to the computer's USB input jack with the included USB Cable UC-E6.

- Before connecting to a computer, install ViewNX 2 on the computer using the included ViewNX 2 Installer CD-ROM. For information about using the ViewNX 2 Installer CD-ROM and transferring images to a computer, see page 75.
- If any USB devices that draw the power from the computer are connected, disconnect them from the computer before you connect the camera to it.
- Connecting the camera and other USB-powered devices to the same computer simultaneously may cause a camera malfunction or excessive power supply from the computer, which could damage the camera or memory card.

Printing images without using a computer



If you connect the camera to a PictBridge-compatible printer, you can print images without using a computer.

Connection method: Connect the camera directly to the printer's USB input jack with the included USB Cable UC-E6.

Using ViewNX 2

ViewNX 2 is an all-in-one software package which enables you to transfer, view, edit and share images.

Install ViewNX 2 using the ViewNX 2 Installer CD-ROM.



Installing ViewNX 2

- An Internet connection is required.

Compatible Operating Systems

Windows

- Windows 7 Home Basic/Home Premium/Professional/Enterprise/Ultimate
- Windows Vista Home Basic/Home Premium/Business/Enterprise/Ultimate (Service Pack 2)
- Windows XP Home Edition/Professional (Service Pack 3)

Mac OS

- Mac OS X (version 10.5.8, 10.6.7)

Refer to the Nikon website for the latest information on operating system compatibility.

-
- 1** Start the computer and insert the ViewNX 2 Installer CD-ROM into the CD-ROM drive.

- Mac OS: When the **ViewNX 2** window is displayed, double-click the **Welcome** icon.

2 Select a language in the language selection dialog to open the installation window.

- If the desired language is not available, click **Region Selection** to choose a different region and then choose the desired language (the **Region Selection** button is not available in the European release).
- The installation window is displayed.

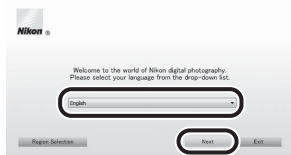

3 Start the installer.

- We recommend clicking **Installation Guide** in the installation window to check the installation help information and system requirements before installing ViewNX 2.
- Click **Typical Installation (Recommended)** in the installation window.

4 Download the software.

- When the **Software Download** screen is displayed, click **I agree - Begin download**.
- Follow the on-screen instructions to install the software.

5 Exit the installer when the installation completion screen is displayed.

- Windows: Click **Yes**.
- Mac OS: Click **OK**.

The following software is installed:

- ViewNX 2 (consisting of the three modules below)
 - Nikon Transfer 2: For transferring images to the computer
 - ViewNX 2: For viewing, editing, and printing transferred images
 - Movie Editor: For basic editing of transferred movies
- Panorama Maker 5 (for creating a single panorama photo using a series of images shot in panorama assist scene mode)
- QuickTime (Windows only)

6 Remove the ViewNX 2 Installer CD-ROM from the CD-ROM drive.

Transferring Images to the Computer

1 Choose how images will be copied to the computer.

Choose one of the following methods:

- **Direct USB connection:** Turn the camera off and ensure that the memory card is inserted in the camera. Connect the camera to the computer using the supplied USB Cable UC-E6. The camera automatically turns on.

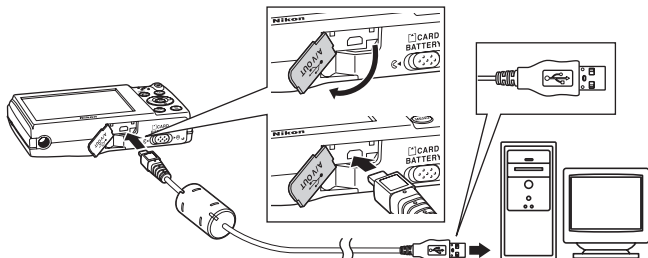

- **SD card slot:** If your computer is equipped with an SD card slot, the card can be inserted directly in the slot.
- **SD card reader:** Connect a card reader (available separately from third-party suppliers) to the computer and insert the memory card.

If a message is displayed prompting you to choose a program, select Nikon Transfer 2.

• When using Windows 7

If the dialog shown at right is displayed, follow the steps below to select Nikon Transfer 2.

- 1 Select Nikon Transfer 2 for **Import pictures and videos**. Under **Import pictures and videos**, click **Change program**. A program selection dialog will be displayed; select **Import File using Nikon Transfer 2** and click **OK**.
- 2 Double-click **Import File**.



If the memory card contains a large number of images, it may take a while for Nikon Transfer 2 to start. Wait until Nikon Transfer 2 starts.

✓ Connecting the USB Cable

The connection may not be recognized if the camera is connected to the computer via a USB hub.

2 Transfer images to the computer.

- Confirm that the name of the connected camera or removable disk is displayed in the “Source” panel in the Nikon Transfer 2 “Options” area (①).
- Click **Start Transfer** (②).

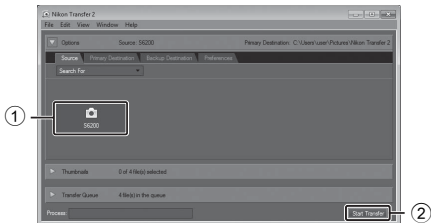

- At default settings, all the images on the memory card will be copied to the computer.

3 Terminate the connection.

- If the camera is connected to the computer, turn the camera off and disconnect the USB cable.
- If a card reader or card slot is used, choose the appropriate option in the computer operating system to eject the removable disk corresponding to the memory card and then remove the card from the card reader or card slot.

Viewing Images

Start ViewNX 2.

- Images are displayed in ViewNX 2 when transfer is complete.
- Consult online help for more information on using ViewNX 2.



Starting ViewNX 2 Manually

- **Windows:** Double-click the **ViewNX 2** shortcut icon on the desktop.
- **Mac OS:** Click the **ViewNX 2** icon in the Dock.

Retouching Photographs

Click **Edit** in the ViewNX 2 toolbar.

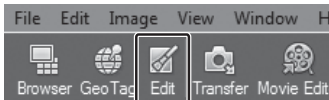
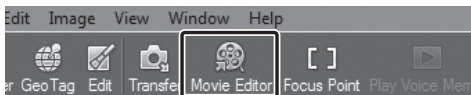

Image editing functions include tone compensation, sharpness adjustment, and trimming (cropping).

Editing Movies

Click **Movie Editor** in the ViewNX 2 toolbar.



Movie editing functions include the ability to delete unwanted scenes.

Printing Images

Click **Print** in the ViewNX 2 toolbar.

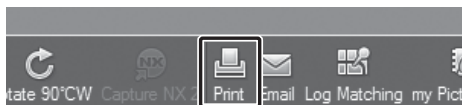

A dialog is displayed and images can be printed using a printer connected to the computer.



A series of horizontal dashed lines for handwriting practice, starting from the top right and extending across the page.

Recording and Playing Back Movies

You can record movies by simply pressing the  (movie-record) button.

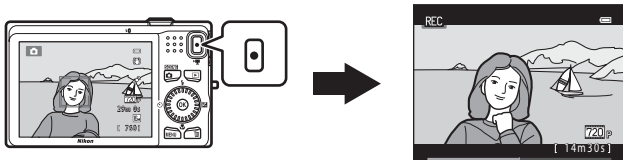

In playback mode, press the  button to play a movie.

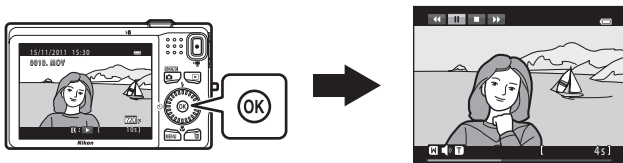

Recording Movies

You can record movies by simply pressing the **●** (▶ movie-record) button. Color tones, white balance, and other settings are the same when recording movies as they are when taking pictures.

1 Display the shooting screen.

- The icon for the selected movie option is displayed. The default setting is **720p HD 720p (1280×720)** (85).
- * The remaining recording time shown in the illustrations in this manual is for example purposes only.

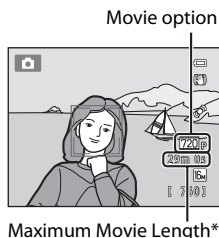

Maximum Movie Length*

2 Press the **●** (▶ movie-record) button to start movie recording.

- The camera focuses on the subject in the center of the frame. Focus areas are not displayed during recording.
- When **720p HD 720p (1280×720)** or **iFrame 540 (960×540)** is selected for **Movie options**, monitor display changes to an aspect ratio of 16:9 with movie recording (the area indicated on the right is recorded).
- If **Photo info** in the **Monitor settings** (88) in the setup menu is set to **Movie frame+auto info**, the area that will be visible in the movie can be confirmed before movie recording starts.
- The approximate remaining movie length is displayed. **||||** is displayed while saving to the internal memory.
- Recording stops automatically when the maximum movie length has been recorded.

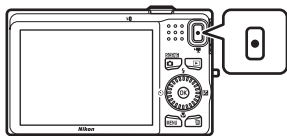

3 Press the **●** (▶ movie-record) button again to end recording.

✓ Notes About Saving Movies

After a movie has been recorded, it is not fully saved to the internal memory or memory card until monitor display returns to the shooting display. **Do not open the battery-chamber/memory card slot cover** before movies have been fully saved. Removing the memory card or the battery while a movie is being saved may result in loss of the movie data or damage to the camera or to the memory card.

✓ Notes About Movie Recording

- Memory cards with an SD Speed Class rating of 6 or faster are recommended when recording movies (📖 19). Movie recording may stop unexpectedly when memory cards with a lower Speed Class rating are used.
- There may be some degradation in image quality when digital zoom is used. When recording ends, digital zoom turns off.
- The sounds of zoom control operation, zoom, autofocus lens drive movement, vibration reduction, and aperture operation when brightness changes may be recorded.
- Smear (👁️-3) visible in the monitor with movie recording will be recorded with movies. Avoiding bright objects such as the sun, reflections of the sun, and electric lights is recommended.
- Depending on the distance to the subject or the amount of zoom applied, subjects with repeating patterns (fabrics, lattice windows, etc.) may have colored stripes (interference patterns, moire, etc.) in them during movie recording and playback. This occurs when the pattern in the subject and the layout of the image sensor interfere with each other; it is not a malfunction.

✓ Camera Temperature

- The camera may become warm when shooting movies for an extended period of time or when the camera is used in a hot area.
- If the inside of the camera becomes extremely hot when recording movies, the camera will automatically stop recording after 30 seconds.

The amount of time remaining until the camera stops recording (🕒 30 s) is displayed.

Five seconds after the camera stops recording, it turns itself off. Leave the camera off until the inside of the camera has cooled.

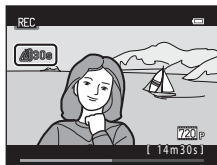



✓ Notes About Autofocus

Autofocus may not perform as expected (📖 29). Should this occur, try the following:

1. Set **Autofocus mode** in the movie menu to **AF-S Single AF** (default setting) before starting movie recording.
2. Frame another subject—positioned at the same distance from the camera as the intended subject—in the center of the frame, press the **● (📷 movie-record)** button to start recording, and then modify the composition.



Movie Options and Maximum Movie Length

Movie options (📖 85)	Internal memory (approx. 74 MB)	Memory card (4 GB)*
 HD 720p (1280×720) (default setting)	1 min 14 s	1 h 20 min
 iFrame 540 (960×540)	21 s	20 min
 VGA (640×480)	2 min 38 s	2 h 55 min

All figures are approximate. The maximum movie length may vary depending on the make of the memory card, even among memory cards of the same capacity.

* The maximum file size for a single movie is 4 GB and the maximum movie length for a single movie is 29 minutes, even when there is sufficient free space on the memory card for longer recording. When recording a movie, the remaining recording time that is displayed is the amount of recording time available for one movie.

Functions Available with Movie Recording





- The exposure compensation, white balance, and color options settings for the current shooting mode are also applied with movie recording. The tone that results from using scene mode (📖 39) or special effects mode (📖 47) is also applied to movies. When macro mode is enabled, movies of subjects closer to the camera can be recorded. Confirm settings before starting movie recording.
- The self-timer (📖 58) can be used. When the  button is pressed after the self-timer is enabled, the camera focuses on the subject in the center of the frame and starts movie recording after the specified two or ten seconds.
- The flash will not fire.
- Press the **MENU** button to select the  (movie) tab and adjust movie menu settings before starting movie recording (📖 85).

Changing Movie Recording Settings (the Movie Menu)

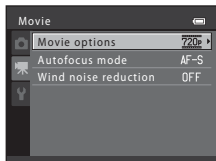
Enter shooting mode → MENU → 菜单 tab (📖 10)

The following settings can be changed.



Option	Description	📖
Movie options	The following movie types are available: 720p HD 720p (1280×720) ,  iFrame 540 (960×540) , and VGA (640×480) .	 52
Autofocus mode	When AF-S Single AF (default setting) is selected, focus is locked when movie recording begins. When AF-F Full-time AF is selected, the camera focuses continuously while recording. When AF-F Full-time AF is selected, the sound of the camera focusing may be heard in recorded movies. If you want to prevent the sound of the camera focusing from being recorded, select AF-S Single AF .	 53
Wind noise reduction	Set whether or not to reduce wind noise during movie recording.	 53

Playing Back Movies

Press the  button to enter playback mode.

Movies are indicated by the movie options icon ( 85).



Press the  button to play back movies. **Movie options**



Functions Available During Playback







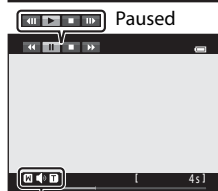









Rotate the multi selector to advance or rewind the movie.

Playback controls are displayed at the top of the monitor.

Press the multi selector  or  to select a control. The operations described below are available.



Volume indicator **During playback**





Function	Icon	Description
Rewind		Hold down the  button to rewind the movie.
Advance		Hold down the  button to advance the movie.
Pause		Press the  button to pause playback. The following operations can be performed while playback is paused using the controls displayed at the top in the monitor.
		 Press the  button to rewind the movie. Hold down the  button for continuous rewinding.*
		 Press the  button to advance the movie. Hold down the  button for continuous advancing.*
		 Press the  button to resume playback.
End		Press the  button to return to full-frame playback mode.

* The movie can also be advanced or rewound by rotating the multi selector.

Adjusting volume

Rotate the zoom control to **T** or **W** ( 2) during playback.

Deleting movies

To delete a movie, select the desired movie in full-frame playback mode ( 30) or thumbnail playback mode ( 31) and press the  button ( 32).

Notes About Playing Back Movies

The COOLPIX S6200 is not able to play back movies recorded with another make or model of digital camera.

General Camera Setup

This chapter describes the various settings that can be adjusted in the  setup menu.

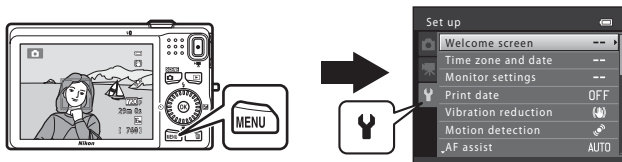

- See “Using Menus (the **MENU** Button)” (📖 10) for information about using the camera’s menus.
- For further details about each setting, refer to “The Setup Menu” in the Reference Section (🔧 54).







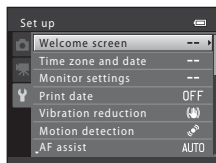







The Setup Menu

Press the **MENU** button → **Y** (setup) tab (📖 10)









The following settings can be changed in the setup menu by selecting the **Y** tab.



Option	Description	📖
Welcome screen	Allows you to select the image displayed as the welcome screen when the camera is turned on. Select COOLPIX to display the COOLPIX logo. Select Select an image to use a picture taken with the camera as the welcome screen. The welcome screen is not displayed by default.	👓54
Time zone and date	Allows you to set settings related to the camera's date and time. The Time zone setting allows you to specify the time zone where the camera is mainly used and whether or not daylight saving time is in effect. When the travel destination (📍) is selected, the camera automatically calculates the time difference between the travel destination and the home time zone (🏠), and saves images using the date and time of the travel destination.	👓55
Monitor settings	Allows you to adjust settings related to the monitor. <ul style="list-style-type: none"> • Photo info allows you to select the kind of information that is displayed during shooting mode and playback mode. If you select Framing grid+auto info, a grid is displayed when shooting to help you frame the shot. • The Image review setting allows you to determine whether or not the captured image is displayed immediately after shooting. • Brightness allows you to adjust the brightness of the monitor. 	👓58
Print date	Allows you to imprint the shooting date and time on images at the time of shooting. The default setting is Off . <ul style="list-style-type: none"> • The shooting date and time are not imprinted on panorama images or movies. 	👓60
Vibration reduction	Allows you to reduce blurring caused by camera shake when shooting. The default setting is Off . <ul style="list-style-type: none"> • When using a tripod to stabilize the camera during shooting, set this feature to Off to prevent this feature from malfunctioning. 	👓61

Option	Description	
Motion detection	<p>When set to Auto (default setting), if the camera detects camera shake or subject movement at the time of shooting, it automatically increases ISO sensitivity and shutter speed to reduce blurring. The  indicator glows green when the camera detects camera shake and increases shutter speed.</p> <ul style="list-style-type: none"> When using certain shooting modes or settings, motion is not detected. In these cases the  indicator is not displayed. 	 62
AF assist	<p>When set to Auto (default setting), the AF-assist illuminator ( 2) lights when shooting in dark surroundings to help the camera focus.</p> <ul style="list-style-type: none"> The illuminator has a range of about 1.9 m (6 ft 2 in.) at the maximum wide-angle position and about 1.1 m (3 ft 7 in.) at the maximum telephoto position. Even if Auto is selected, the AF-assist illuminator may not light depending on the position of the focus area or the scene mode that is selected. 	 63
Digital zoom	<p>When set to On (default setting), if you rotate the zoom control to T () when the camera is already zoomed in to the maximum optical zoom position, the digital zoom is activated ( 27).</p>	 63
Sound settings	<p>Allows you to turn various camera sounds on and off.</p> <ul style="list-style-type: none"> Camera operation sounds are not heard when using certain modes, such as the Pet portrait scene mode. 	 64
Auto off	<p>Allows you to set the amount of time that passes before the monitor turns off to save power. The default setting is 1 min.</p>	 65
Format memory/ Format card	<p>Allows you to format the internal memory (only when a memory card is not inserted) or the memory card (when a memory card is inserted).</p> <ul style="list-style-type: none"> All data stored in the internal memory or on the memory card is deleted during formatting and cannot be restored. Be sure to save important images by transferring them to a computer before formatting. 	 66
Language	<p>Allows you to change the camera's display language.</p>	 67
TV settings	<p>Set these settings to match your TV. You can select the video output mode (NTSC or PAL) and adjust HDMI output settings.</p>	 68

The Setup Menu

Option	Description	
Charge by computer	<p>When set to Auto (default setting), you can charge the camera's battery by connecting the camera to a computer (provided that the computer is able to supply power).</p> <ul style="list-style-type: none"> When charging by computer, it may take more time to charge the battery than when using the Charging AC Adapter EH-69P. Additionally, when charging by computer and transferring images to the computer, it takes more time to charge the battery. 	 69
Blink warning	<p>Immediately after taking a picture using face detection ( 67) (except when using smart portrait mode), if the camera detects a subject with closed eyes, the camera displays the message Did someone blink?, allowing you to check the image. The default setting is Off.</p>	 71
Filmstrip	<p>When On is selected, thumbnails of previous and subsequent images are displayed in the bottom of the monitor when you rotate the multi selector quickly while viewing an image in full-frame playback mode ( 30). The default setting is Off.</p>	 73
Reset all	<p>Allows you to reset the camera's settings to their default values.</p> <ul style="list-style-type: none"> Certain settings such as Time zone and date and Language are not reset. 	 74
Firmware version	View the current camera firmware version.	 76



Reference Section

The Reference Section provides detailed information and hints about using the camera.

Shooting

Using Panorama Assist	2
-----------------------------	---

Playback

Favorite Pictures Mode.....	4
Auto Sort Mode	7
List by Date Mode	9
Editing Still Images	10
Connecting the Camera to a TV (Viewing Images on a TV).....	21
Connecting the Camera to a Printer (Direct Print)	23

Menu



The Shooting Menu (for (Auto) Mode).....	30
The Smart Portrait Menu.....	38
The Subject Tracking Menu	40
The Playback Menu.....	41
The Movie Menu	52
The Setup Menu.....	54

Additional Information

File and Folder Names	77
Optional Accessories.....	78
Error Messages	79

Using Panorama Assist



The camera focuses on the subject in the center of the frame. Use a tripod for the best results. Set **Vibration reduction** (📷61) to **Off** in the setup menu when using a tripod to stabilize the camera.

- 1** Press the  button in shooting mode and use the multi selector to select  (**Panorama assist**) scene mode (📖 39).

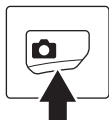
- Panorama direction icons are displayed to show the direction in which images will be joined.



- 2** Use the multi selector to select the direction and press the  button.

- Select the direction in which images will be joined in the completed panorama; right (▶), left (◀), up (▲), or down (▼).
- The yellow panorama direction icon (▶▶) is displayed for the current direction and the direction is fixed when the  button is pressed. The icon changes to the white fixed direction ▶ icon.
- If necessary, apply flash mode (📖 56), self-timer (📖 58), macro mode (📖 59), and exposure compensation (📖 60) settings with this step.
- Press the  button again to select a different direction.



- 3** Frame the first portion of the panorama scene and take the first picture.

- One third of the image will be displayed as translucent.



- 4** Take the next picture.

- Frame the next image so that one third of the frame overlaps the first image, and press the shutter-release button.
- Repeat this process until the necessary number of images has been taken to complete the scene.



5 Press the **OK** button when shooting is complete.

- The camera returns to step 2.



✓ Notes About Panorama Assist

- Flash mode, self-timer, macro mode, and exposure compensation settings cannot be adjusted after the first picture is taken. Images cannot be deleted, nor can zoom or **Image mode** settings (📖 63) be adjusted after the first picture has been taken.
- Shooting for the panorama series is terminated if the auto off function (🔋 65) initiates standby mode during shooting. Setting the time allowed to elapse before the auto off function is enabled to a longer setting is recommended.

📌 AE/AF-L Indicator

In **Panorama assist** scene mode, exposure, white balance, and focus for all images in a panorama are fixed at the values for the first image in each series.

When the first picture is taken, **AE/AF-L** is displayed to indicate that exposure, white balance, and focus are locked.

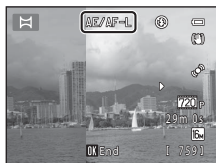

📌 Combining Images to Make a Panorama

- Transfer images to a computer (📖 77) and use Panorama Maker 5 to join them in a single panorama.
- Install Panorama Maker 5 from the included ViewNX 2 Installer CD-ROM.
- After installing Panorama Maker 5, start the software as explained below.
 - Windows: Select the **Start** menu > **All Programs** > **ArcSoft Panorama Maker 5** > **Panorama Maker 5**
 - Mac OS X: Open the **Applications** folder > double-click **Panorama Maker 5**
- For more information about using Panorama Maker 5, refer to the on-screen instructions and help information contained in Panorama Maker 5.

📌 More Information

See "File and Folder Names" (🔍 77) for more information.

Favorite Pictures Mode

After shooting, you can add your favorite still images to albums; there are nine albums available. After you add images to an album, you can use favorite picture mode to view those images easily.

- By creating albums for certain subjects or events, you can find your favorite images easily.
- The same image can be added to multiple albums.
- Up to 200 images can be added to each album.

Adding Images to Albums

- 1** Find the image you want to add and display it in full-frame playback mode (📖 30), and then press the **OK** button.

- Images cannot be added to albums while using favorite pictures mode.

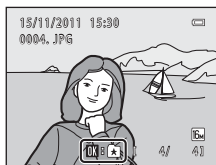

- 2** Use the multi selector to select the desired album and press the **OK** button.

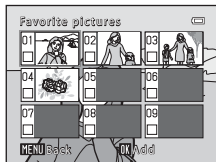

Playing Back Images in Albums

If you select **Favorite pictures** mode when changing the playback mode (📖 72), the album selection screen is displayed.

Use the multi selector to select an album and then press the **OK** button to play back the images that have been added to the selected album.

- The following operations are available from the album selection screen.
 - MENU** button: Changes the album icon (👁️6).
 - 🗑️** button: Deletes all images in the selected album.
- When viewing images in full-frame playback mode or thumbnail playback mode, press the **MENU** button to display the menu and then select the **Favorite pictures menu** (📖 73).

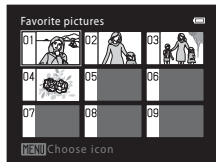

Removing Images from Albums

Press the **OK** button in full-frame playback mode in favorite pictures mode to remove the image. A confirmation screen is displayed. Select **Yes** and press the **OK** button to remove the image.

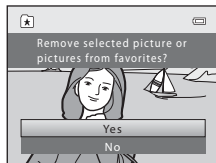

✔ Notes About Deletion

When images are added to an album, they are not moved or copied to the album. Only the image file names are added to the album. During playback, images are retrieved according to their file names.

If an image is deleted while using favorite pictures mode, the image will not only be removed from the album, but the corresponding image file will also be permanently deleted from the internal memory or the memory card.

Changing the Favorites Album Icon

From the album selection screen (📷5), select an album and press the **MENU** button to change the album's icon.

- Select a color, press the **OK** button, and then select an icon and press the **OK** button to change the icon.

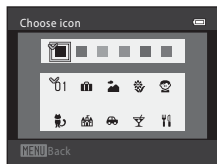

✓ Notes About Album Icons

- Set the album icons separately for the internal memory and for the memory card.
- To change the album icons for the internal memory, first remove the memory card from the camera.
- The default setting for the icon is the number icon (black).

Auto Sort Mode

Images are automatically sorted in to categories, such as portraits, landscapes, and movies.

If you select **AUTO** **Auto sort** mode when changing the playback mode (📖 72), the category selection screen is displayed.

Use the multi selector to select a category and then press the **OK** button to play back the images in the selected category.





Auto Sort Mode Categories

Option	Description
Smile	Images captured in smart portrait mode (📖 49) with the smile timer setting set to On
Portrait	Images captured in (auto) mode (📖 24) with the face detection (📖 67) Images captured in Portrait* , Night portrait* , Party/indoor , and Backlighting* scene mode (📖 39) Images captured in smart portrait mode (📖 49) with the smile timer setting set to Off
Food	Images captured in Food scene mode (📖 39)
Landscape	Images captured in Landscape* scene mode (📖 39)
Dusk to dawn	Images captured in Night landscape* , Sunset , Dusk/dawn , and Fireworks show scene mode (📖 39)
Close-up	Images captured in (auto) mode with macro mode (📖 59) Images captured in Close-up* scene mode (📖 39)
Pet portrait	Images captured in the Pet portrait (📖 46) scene mode
Movie	Movies (📖 82)
Retouched copies	Copies created using editing functions (🎮 10)
Other scenes	All other images that cannot be defined by the categories described above

* Images captured in scene auto selector scene mode (📖 40) are also sorted to the appropriate categories.

- The following operations are available while the category selection screen is displayed.
 - button: Deletes all images in the selected category.
- When viewing images in full-frame playback mode or thumbnail playback mode, press the **MENU** button to display the menu and then select the **AUTO** (auto sort menu) tab to select a feature from the playback menu (📖 73).

Notes About Auto Sort Mode

- Up to 999 images and movie files can be sorted to each category in auto sort mode. If 999 images or movies have already been sorted to a specific category, new images and movies cannot be sorted to that category nor can they be displayed in auto sort mode. You can play back images and movies that could not be sorted to a category by using normal playback mode ( 30) or list by date mode (.
- Images copied from the internal memory to a memory card, or vice versa (, cannot be played back in auto sort mode.
- Images or movies saved by a camera other than the COOLPIX S6200 cannot be played back in auto sort mode.

List by Date Mode

If you select **12** **List by date** mode when changing the playback mode (📖 72), the shooting date selection screen is displayed.

Use the multi selector to select a date and then press the **OK** button to play back the images captured on the selected date.

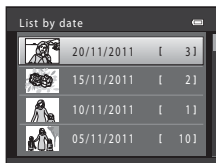

- The first image that was captured on the selected date is displayed.
- The following operations are available while the shooting date selection screen is displayed.
 - **MENU** button: When you select the **12** tab (list by date menu) from the menu, you can select one of the following functions in the playback menu (📖 73) and apply it to all images captured on the selected date.
 - print order, slide show, protect
 - **🗑** button: Deletes all images captured on the selected date.
- When viewing images in full-frame playback mode or thumbnail playback mode, press the **MENU** button to display the menu and then select the **12** (list by date menu) tab to select a feature from the playback menu (📖 73).
- Calendar display mode (📖 31) cannot be used in list by date mode.

✓ Notes About List by Date Mode

- Up to 29 dates can be displayed. If images exist for more than 29 dates, all images saved earlier than most recent 29 dates will be combined under **Others**.
- The 9,000 most recent images can be displayed in list by date mode.
- Images captured when the camera's date is not set are treated as images captured on January 1, 2011.

Editing Still Images

Editing Features

Use the COOLPIX S6200 to edit images in-camera and save them as separate files (📷77). The editing functions described below are available.

Editing function	Description
Quick retouch (📷12)	Easily create retouched copies in which contrast and saturation have been enhanced.
D-Lighting (📷13)	Create a copy of the current image with enhanced brightness and contrast, brightening dark portions of the image.
Skin softening (📷14)	Make facial skin tones softer.
Filter effects (📷16)	Digital filter effects can be used to apply a variety of effects to images. Effect types include Soft , Selective color , Cross screen , Fisheye , Miniature effect , and Painting .
Small picture (📷18)	Create a small copy of images suitable for use as e-mail attachments.
Crop (📷19)	Crop a portion of the image. Use to zoom in on a subject or arrange a composition.

✓ Notes About Image Editing

- Images captured at an **Image mode** (📖 63) setting of 📷 **4608x2592** cannot be edited.
- This camera cannot edit images captured with another make or model of digital camera.
- If no face is detected in an image, a copy cannot be created using the skin softening function (📷14).
- Edited copies created with this camera may not be displayed properly on another make or model of digital camera. It may also be impossible to transfer them to a computer using another make or model of digital camera.
- Editing functions are not available when there is not enough free space in the internal memory or on the memory card.



Restrictions on Image Editing

When an edited copy is further modified with another editing function, check the following restrictions.

Editing function used	Editing functions that can be added
Quick retouch D-Lighting Filter effects	The skin softening, small picture, or crop function can be added. The quick retouch, D-Lighting, and filter effects functions cannot be used together.
Skin softening	The quick retouch, D-Lighting, filter effects, small picture, or crop function can be added.
Small picture Crop	Another editing function cannot be added.



- Copies created with editing functions cannot be further edited with the same function used to create them.
- When combining the small picture or crop function and another editing function, use the small picture and crop functions after other editing functions have been applied.
- You can apply skin softening to images that were captured using skin softening (38).

Original and Edited Images

- Copies created with editing functions are not deleted if the original images are deleted. The original images are not deleted if copies created with editing functions are deleted.
- Edited copies are saved with the same shooting date and time as the original.
- Print marking (41) and protect settings (46) do not remain effective in edited copies.

Quick Retouch: Enhancing Contrast and Saturation

Quick retouch can be used to easily create retouched copies in which contrast and saturation have been enhanced. Copies created with the quick retouch function are saved as separate files.

- 1 Display the desired image in full-frame playback mode ( 30) or thumbnail playback mode ( 31) and press the **MENU** button.

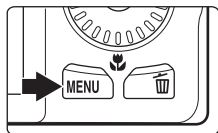

- 2 Use the multi selector to select  **Quick retouch** and press the **OK** button.
 - The original version is displayed on the left and the edited version is displayed on the right.

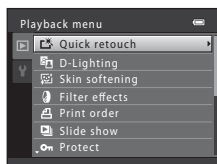

- 3 Press the multi selector **▲** or **▼** to select the amount of effect applied and press the **OK** button.

- A new, edited copy is created.
- To exit without saving the copy, press **◀**.
- Copies created with the quick retouch function are indicated by the  icon displayed during playback.

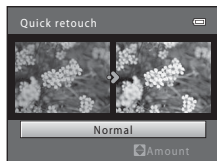



More Information

See "File and Folder Names" () 77) for more information.

D-Lighting: Enhancing Brightness and Contrast

D-Lighting can be used to create copies with enhanced brightness and contrast, brightening dark portions of an image. Enhanced copies are saved as separate files.

- 1 Display the desired image in full-frame playback mode ( 30) or thumbnail playback mode ( 31) and press the **MENU** button.

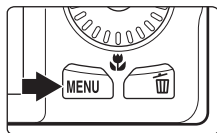

- 2 Use the multi selector to select  **D-Lighting** and press the **OK** button.

- The original version is displayed on the left and the edited version is displayed on the right.

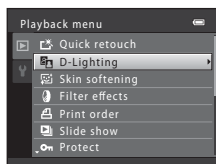

- 3 Select **OK** and press the **OK** button.

- A new, edited copy is created.
- To exit without saving the copy, select **Cancel** and press the **OK** button.
- Copies created with the D-Lighting function are indicated by the  icon displayed during playback.

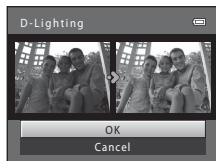



More Information

See "File and Folder Names" ( 77) for more information.

Skin Softening: Softening Skin Tones

The camera detects faces in images and creates a copy with softer facial skin tones. Copies created using the skin softening function are saved as separate files.

- 1 Display the desired image in full-frame playback mode ( 30) or thumbnail playback mode ( 31) and press the **MENU** button.

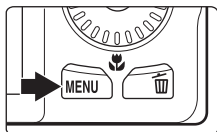

- 2 Use the multi selector to select  **Skin softening** and press the **OK** button.

- The screen for selecting the degree of softening is displayed.
- If no faces are detected in the image, an alert is displayed and the camera returns to the playback menu.

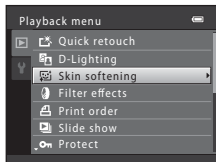

- 3 Press the multi selector **▲** or **▼** to select the degree of softening and press the **OK** button.

- The confirmation dialog is displayed with the face to which skin softening was applied enlarged at the center of the monitor.
- To exit without saving the copy, press **◀**.

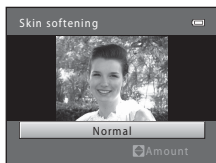

- 4 Check the preview of the copy.

- Skin tones in up to 12 faces, in the order of that closest to the center of the frame, are softened.
- If more than one face was softened, press the multi selector **◀** or **▶** to display a different face.
- Press the **MENU** button to adjust the degree of softening. The monitor display returns to that shown in step 3.
- When the **OK** button is pressed, a new, edited copy is created.
- Copies created with the skin softening function are indicated by the  icon displayed during playback.

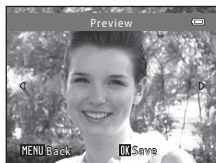

 Notes About Skin Softening



Depending upon the direction in which faces are looking, or the brightness of faces, the camera may be unable to accurately recognize faces, or the skin softening function may not perform as expected.



 More Information

See "File and Folder Names" ()77) for more information.

Filter Effects: Applying Digital Filter Effects

Digital filter effects can be used to apply a variety of effects to images. The following effects are available. Copies created with the filter effects function are saved as separate files.

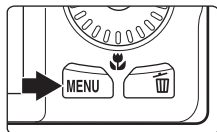

Type	Description
Soft	Soften the image by adding a slight blur around the center of the image. In images captured with face priority ( 67) or pet detection ( 46) selected, areas around faces will be blurred.
Selective color	Keep one specified color in the image, and change the other colors to black and white.
Cross screen	Produce star-like rays of light that radiate outward from bright objects such as sunlight reflections or street lights. This effect is suitable for night scenes.
Fisheye	Make an image look as if it were captured with a fisheye lens. This effect is well-suited for images captured in macro mode.
Miniature effect	Make an image look like a miniature scene captured in macro mode. This effect is well-suited for images captured from a high vantage point with the main subject at the center of the image.
Painting	Gives images a hand-painted appearance.

- 1 Display the desired image in full-frame playback mode ( 30) or thumbnail playback mode ( 31) and press the **MENU** button.

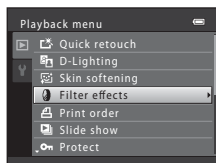

- 2 Use the multi selector to select  **Filter effects** and press the **OK** button.



- 3 Press the multi selector  or  to select an effect, and press the **OK** button.

- When **Cross screen**, **Fisheye**, **Miniature effect**, or **Painting** is selected, proceed to step 5.

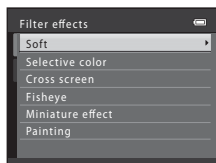

4 Adjust the effect.

- **Soft:** Press ▲ or ▼ to select the range of the effect and press the OK button.

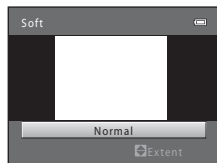

- **Selective color:** The slider is displayed. Rotate the multi selector, or press ▲ or ▼ to select the color to be retained, and press the OK button.

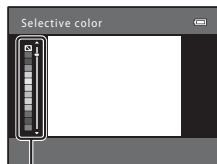

Slider

- Press ◀ to return to the **Filter effects** selection screen without applying effects.

5 Confirm the effect and press the OK button.

- A new, edited copy is created.
- To exit without saving the copy, press ◀.
- Copies created using the filter effects function are indicated by the OK icon displayed during playback.

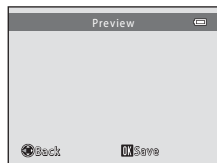



More Information

See "File and Folder Names" (677) for more information.

Small Picture: Reducing the Size of an Image

Create a small copy of the current image. This feature is useful for creating copies for display on Web pages or for e-mail attachments. The **640×480**, **320×240**, and **160×120** sizes are available. Small copies are saved as separate files with a compression ratio of approximately 1:16.

- 1 Display the desired image in full-frame playback mode ( 30) or thumbnail playback mode ( 31) and press the **MENU** button.

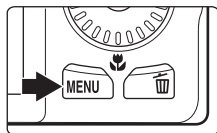

- 2 Use the multi selector to select  **Small picture** and press the **OK** button.

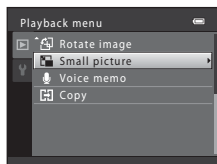

- 3 Select the desired copy size and press the **OK** button.

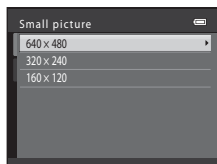

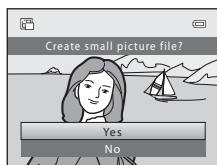

- 4 Select **Yes** and press the **OK** button.
 - A new, small copy is created.
 - To exit without saving the copy, select **No** and press the **OK** button.
 - The copy is displayed with a black frame.



More Information

See "File and Folder Names" () 77) for more information.

Crop: Creating a Cropped Copy

Create a copy containing only the portion visible in the monitor when **MENU**  is displayed with playback zoom ( 31) enabled. Cropped copies are saved as separate files.





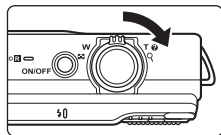

1 Rotate the zoom control to **T** () in full-frame playback mode (30) to zoom in on the image.

- To crop an image displayed in “tall” (portrait) orientation, zoom in on the image until the black bars displayed on the both sides of the monitor disappear.



The cropped image will be displayed in landscape orientation. To crop the image in its current “tall” (portrait) orientation, first use the **Rotate image** option ( 48) to rotate the image so that it is displayed in landscape orientation. Next, enlarge the image for cropping, crop the image, and then rotate the cropped image back to “tall” (portrait) orientation.

2 Refine copy composition.

- Rotate the zoom control to **T** () or **W** () to adjust the zoom ratio.
- Press the multi selector , , , or  to scroll the image so that only the portion to be copied is visible in the monitor.



3 Press the **MENU** button.

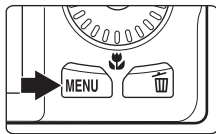

4 Use the multi selector to select **Yes** and press the **OK** button.

- A cropped copy is created.
- To exit without saving the copy, select **No** and press the **OK** button.



Editing Still Images

Image Size

As the area to be saved is reduced, the image size (pixels) of the cropped copy is also reduced. When the image size of the cropped copy is 320 × 240 or 160 × 120, a black frame is displayed around the image, and the small picture icon  is displayed in the left of the monitor in playback mode.

More Information

See "File and Folder Names" () for more information.

Connecting the Camera to a TV (Viewing Images on a TV)

Connect the camera to a TV to play back images or movies back on the TV. If your TV is equipped with an HDMI jack, a commercially available HDMI cable can be used to connect the camera to the TV.

- 1 Turn off the camera.

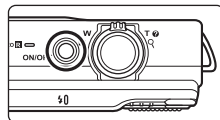

- 2 Connect the camera to the TV.

When using the included audio/video cable

Connect the yellow plug to the video-in jack and the white and red plugs to the audio-in jacks on the TV.

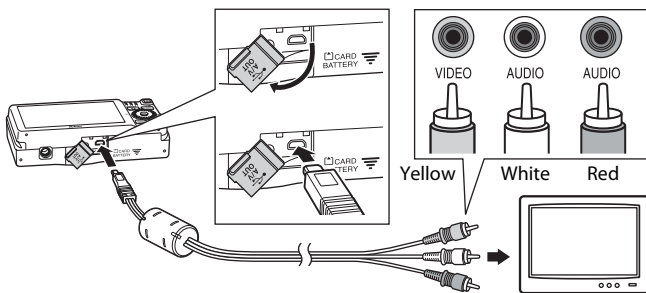

When using a commercially available HDMI cable

Connect the plug to the HDMI jack on the TV.

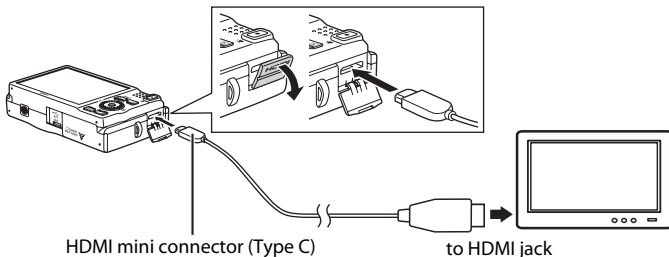

3 Set the TV's input to external video input.



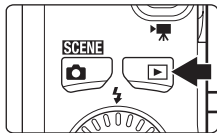

- See the documentation provided with your TV for details.

4 Hold down the button to turn on the camera.

- The camera enters playback mode and images are displayed on the TV.
- While connected to the TV, the camera monitor will remain off.



Notes About Connecting the HDMI Cable

- An HDMI cable is not included. Use a commercially available HDMI cable to connect the camera to a high-definition TV. The output terminal on this camera is an HDMI mini connector (type C). When purchasing an HDMI cable, be sure that the device end of the cable is an HDMI mini connector.
- We recommend shooting still images at an **Image mode** ( 63) setting of  **2048×1536** or higher, and movies at a **Movie options** ( 52) setting of  **HD 720p (1280×720)**.

Notes About Connecting the Cable

- When connecting the cable, be sure that the camera connector is properly oriented. Do not use force when connecting the cable to the camera. When disconnecting the cable, do not pull the connector at an angle.
- Do not connect cables to the HDMI mini connector (Type C) and to the USB/audio/video output connector simultaneously.

If the Images Are Not Displayed on the TV

Be sure that the camera's video mode setting in the **TV settings** ( 68) under the setup menu conforms to the standard used by your TV.

Using a TV Remote Control (HDMI Device Control)

The remote control of an HDMI-CEC-compatible TV can be used to control playback.

It can be used instead of the camera's multi selector and zoom control to select images, start and pause movie playback, and switch between full-screen playback mode and 4-image thumbnail display.

- Set the **HDMI device control** setting ( 68) of **TV settings** to **On** (default setting) and then connect the camera and TV using an HDMI cable.
- Aim the remote control at the TV when operating it.
- Refer to the TV's operating instructions for information about the TV's HDMI-CEC compatibility.

Connecting the Camera to a Printer (Direct Print)

Users of PictBridge-compatible (🔦18) printers can connect the camera directly to the printer and print images without using a computer.

Follow the procedures below to print images.

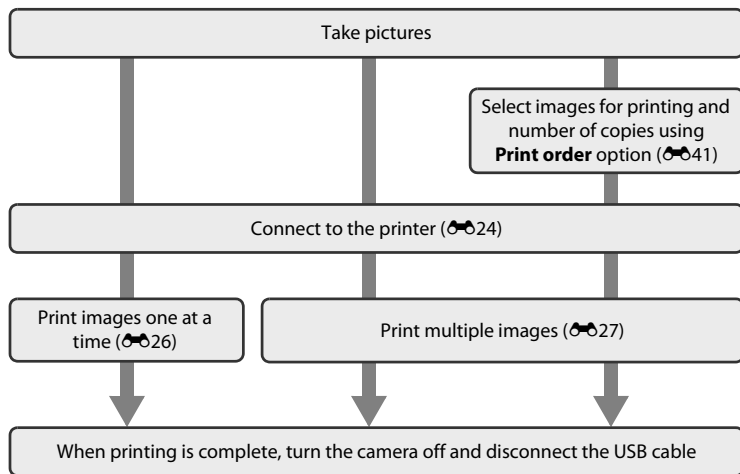

✔ Notes About Power Source

- When connecting the camera to a printer, use a fully charged battery to prevent the camera from turning off unexpectedly.
- If the AC Adapter EH-62F (available separately) is used, COOLPIX S6200 can be powered from an electrical outlet. Do not use any other make or model of AC adapter as it may cause the camera to heat up or malfunction.

📎 Printing Images

In addition to printing images transferred to a computer from your personal printer and printing over a direct camera-to-printer connection, the following options are also available for printing images saved on the memory card:

- Inserting a memory card into a DPOF-compatible printer's card slot
- Taking a memory card to a digital photo lab

For printing using these methods, specify the images and the number of prints each to the memory card using the **Print order** option in the playback menu (🔦41).

Connecting the Camera to a Printer

1 Turn off the camera.

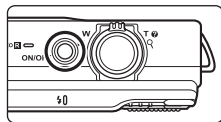

2 Turn on the printer.

- Check printer settings.

3 Connect the camera to the printer using the included USB cable.

- Be sure that connectors are properly oriented. Do not attempt to insert connectors at an angle, and do not use force when connecting or disconnecting the USB cable.

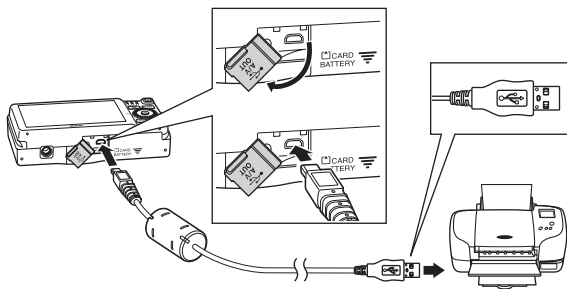

4 The camera is automatically turned on.

- When properly connected, the **PictBridge** startup screen (1) will be displayed in the camera monitor, followed by the **Print selection** screen (2).

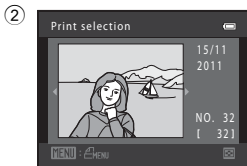
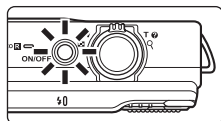

 **If the PictBridge Startup Screen Is not Displayed**

Turn the camera off and disconnect the USB cable. Set the **Charge by computer** option (0069) in the camera's setup menu to **Off** and reconnect the cable.

Printing Individual Images

After properly connecting the camera to the printer (📷24), follow the procedures described below to print an image.

1 Use the multi selector to select the desired image and press the **OK** button.

- Rotate the zoom control to **W** (📷) to display 12 thumbnails, and **T** (📺) to switch back to full-frame playback.

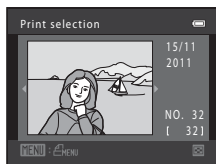

2 Select **Copies** and press the **OK** button.

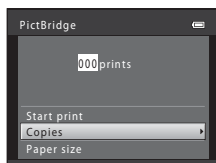

3 Select the desired number of copies (up to nine) and press the **OK** button.

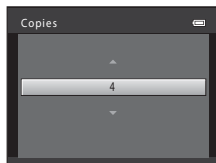

4 Select **Paper size** and press the **OK** button.

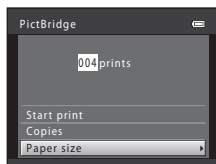

5 Select the desired paper size and press the **OK** button.

- To specify paper size using settings on the printer, select **Default** in the paper size option.

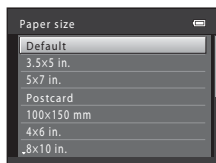

- 6** Select **Start print** and press the **OK** button.

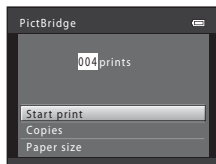

- 7** Printing begins.

- Monitor display returns to the print selection screen shown in step 1 when printing is complete.
- To cancel printing before all copies have been printed, press the **OK** button.

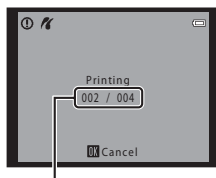

Current number of copies/
total number of copies

Printing Multiple Images

After properly connecting the camera to the printer (24), follow the procedures described below to print multiple images.

- 1** When the **Print selection** screen is displayed, press the **MENU** button.
- The **Print menu** screen is displayed.

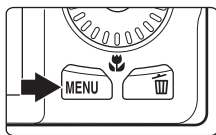

- 2** Use the multi selector to select **Paper size** and press the **OK** button.
- To exit the print menu, press the **MENU** button.

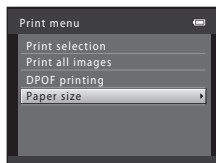

- 3** Select the desired paper size and press the **OK** button.
- To specify paper size using settings on the printer, select **Default** in the paper size option.

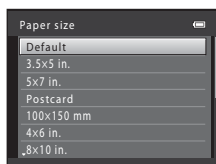

4 Select **Print selection**, **Print all images**, or **DPOF printing** and press the **OK** button.

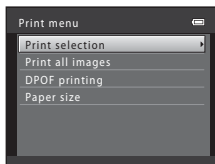

Print selection

Select images (up to 99) and the number of copies (up to nine) of each.

- Rotate the multi selector, or press ◀ or ▶ to select images, and press ▲ or ▼ to specify the number of copies to be printed.
- Images selected for printing are indicated by the check mark (✓) and the numeral indicating the number of copies to be printed. If no copies have been specified for images, the selection is canceled.
- Rotate the zoom control to **T** (Q) to switch back to full-frame playback or **W** (R) to display 12 thumbnails.
- Press the **OK** button when setting is complete.
- When the screen shown on the right is displayed, select **Start print** and press the **OK** button to start printing. Select **Cancel** and press the **OK** button to return to the print menu.

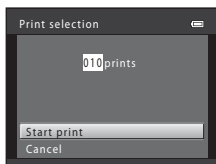
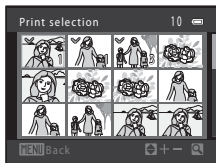

Print all images

One copy each of all images saved in the internal memory, or on the memory card, is printed.

- When the screen shown on the right is displayed, select **Start print** and press the **OK** button to start print. Select **Cancel** and press the **OK** button to return to the print menu.

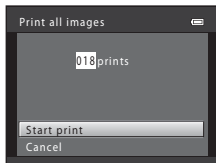

DPOF printing

Print images for which a print order was created using the **Print order** option (41).

- When the screen shown on the right is displayed, select **Start print** and press the **OK** button to start printing. Select **Cancel** and press the **OK** button to return to the print menu.
- To view the current print order, select **View images** and press the **OK** button. To print images, press the **OK** button again.

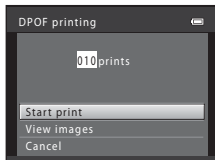

5 Printing begins.

- Monitor display returns to the print menu shown in step 2 when printing is complete.
- To cancel printing before all copies have been printed, press the **OK** button.

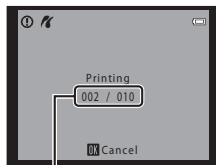

Current number of copies/
total number of copies



Paper Size

The camera supports the following paper sizes: **Default** (the default paper size for the printer connected to the camera), **3.5×5 in.**, **5×7 in.**, **100×150 mm**, **4×6 in.**, **8×10 in.**, **Letter**, **A3**, and **A4**. Only sizes supported by the printer will be displayed.

The Shooting Menu (for (Auto) Mode)







- See “Changing the Image Size (Image Mode)” ( 63) for information about **Image mode**.

White Balance (Adjusting Hue)

Select  (auto) mode → MENU button →  tab → White balance



The color of light reflected from an object varies with the color of the light source. The human brain is able to adapt to changes in the color of the light source, with the result that white objects appear white whether seen in the shade, direct sunlight, or under incandescent lighting. Digital cameras can mimic this adjustment by processing images according to the color of the light source. This is known as “white balance.” For natural colors, select a white balance setting that matches the light source before shooting.

Although **Auto** (the default setting) can be used under most types of lighting, white balance can be adjusted to suit the sky conditions or light source and achieve more natural color tones in the image.

Option	Description
AUTO Auto (default setting)	White balance is automatically adjusted to suit lighting conditions. Best choice in most situations.
PRE Preset manual	Useful when shooting under unusual lighting. See “Using Preset Manual” for more information ( 31).
 Daylight	White balance adjusted for direct sunlight.
 Incandescent	Use under incandescent lighting.
 Fluorescent	Use under fluorescent lighting.
 Cloudy	Use when taking pictures under overcast skies.
 Flash	Use with the flash.

The current white balance setting is indicated by an icon when shooting ( 6). No icon is displayed when **Auto** is selected.

Notes About White Balance

- Some settings cannot be used with other functions ( 65).
- Set the flash to  (off) when white balance is set to any setting other than **Auto** and **Flash** ( 56).

Using Preset Manual

Preset manual is used with mixed lighting or to compensate for light sources with a strong color cast when the desired effect has not been achieved with white balance settings like **Auto** and **Incandescent** (for example, to make images shot under a lamp with a red shade look as though they had been shot under white light).

Use the procedure below to measure the white balance value under the lighting used during shooting.

1 Place a white or gray reference object under the lighting that will be used during shooting.

2 Display the shooting menu (, 10, 37), use the multi selector to select **PRE Preset manual** in the **White balance** menu, and press the **OK** button.

- The camera zooms in to the position for measuring white balance.

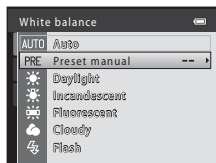

3 Select **Measure**.

- To apply the most recently measured white balance value, select **Cancel** and press the **OK** button. The white balance setting will not be measured again and the most recently measured value will be set.

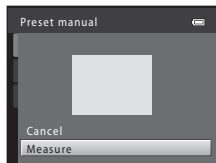

4 Frame the reference object in the measuring window.

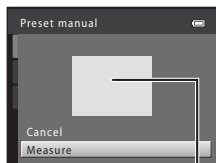

Measuring window



5 Press the **OK** button to measure a value for preset manual.

- The shutter is released and the new white-balance value is set. No image is saved.





Notes About Preset Manual

A value for flash lighting cannot be measured with **Preset manual**. When shooting using the flash, set **White balance** to **Auto** or **Flash**.

Continuous Shooting

Select  (auto) mode → MENU button →  tab → Continuous

Change settings to continuous or BSS (best shot selector).

Option	Description
 Single (default setting)	One picture is taken each time the shutter-release button is pressed.
 Continuous	While the shutter-release button is held all the way down, up to six pictures are taken at a rate of about 1.2 frames per second (fps) (when Image mode is set to  4608×3456).
BSS BSS (best shot selector)	<p>The “best shot selector” is recommended when shooting with the flash off or the camera zoomed in, or in other situations in which inadvertent motion can result in blurred images. When BSS is on, the camera takes up to ten pictures while the shutter-release button is held down. The sharpest image in the series is automatically selected and saved.</p> <ul style="list-style-type: none"> • BSS is best suited to shooting subjects that are not moving. When shooting moving subjects or when the composition of the picture changes while shooting, the desired results may not be achieved.
 Multi-shot 16	<p>Each time the shutter-release button is pressed, the camera takes 16 shots at a rate of about 30 fps and arranges them in a single image.</p> <ul style="list-style-type: none"> • Image mode is fixed at  (image size: 2560 × 1920 pixels). • Digital zoom cannot be used.

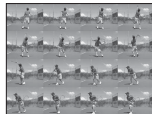

The current continuous shooting setting is indicated by an icon when shooting ( 6). No icon is displayed when **Single** is selected.

Notes About Continuous Shooting

- When **Continuous**, **BSS**, or **Multi-shot 16** is selected, flash cannot be used. Focus, exposure, and white balance are fixed at the values determined with the first image in each series.
- The frame rate with continuous shooting may vary depending upon the current image mode setting, the memory card used, or shooting condition.
- Some settings cannot be used with other functions ( 65).

Notes About Multi-shot 16

Smear ( 3) visible in the monitor when shooting with **Multi-shot 16** enabled will be saved with images. Avoiding bright objects such as the sun, reflections of the sun, and electric lights when shooting with **Multi-shot 16** enabled is recommended.

ISO Sensitivity

Select  (auto) mode → MENU button →  tab → ISO sensitivity



When ISO sensitivity is increased, less light is needed when taking pictures.

Higher ISO sensitivity allows darker subjects to be captured. Additionally, even with subjects of similar brightness, pictures can be taken at faster shutter speeds, and blurring caused by camera shake and subject movement can be reduced.



- Although higher ISO sensitivity is effective when shooting darker subjects, shooting without the flash, shooting while using the zoom, etc., images may contain noise.

Option	Description
Auto (default setting)	Sensitivity is ISO 80 when there is sufficient lighting; the camera compensates by raising sensitivity to a maximum of ISO 1600 when lighting is dim.
Fixed range auto	Select the range in which the camera automatically adjusts ISO sensitivity, from ISO 80-400 or ISO 80-800 . The camera will not increase sensitivity beyond the maximum value in the selected range. Set the maximum value for ISO sensitivity for effective control over the amount of "grain" that appears in images.
80, 100, 200, 400, 800, 1600, 3200	Sensitivity is locked at the specified value.



The current ISO sensitivity setting is indicated by an icon when shooting ( 6).

- When **Auto** is selected, the  icon is not displayed at ISO 80, but is displayed if the ISO sensitivity automatically increases to more than 80.
- When **Fixed range auto** is selected,  and the maximum value for ISO sensitivity is displayed.





Notes About ISO Sensitivity

- Some settings cannot be used with other functions ( 65).
- **Motion detection** ( 62) does not function when the ISO sensitivity is set to any setting other than **Auto**.

Color Options

Select  (auto) mode → MENU button →  tab → Color options

Make colors more vivid or save images in monochrome.

Option	Description
 Standard color (default setting)	Use for images exhibiting natural color.
 Vivid color	Use to achieve a vivid, "photoprint" effect.
 Black-and-white	Save images in black-and-white.
 Sepia	Save images in sepia tones.
 Cyanotype	Save images in cyan-blue monochrome.

The current color options setting is indicated by an icon when shooting ( 6). When **Standard color** is selected, no icon is displayed. Color tones shown in the monitor during shooting change according to the selected color option.





Notes About Color Options

Some settings cannot be used with other functions ( 65).

AF Area Mode

Select  (auto) mode → MENU button →  tab → AF area mode

Use this option to determine how the camera selects the focus area for autofocus.

Option	Description
 Face priority (default setting)	<p>When the camera detects a human face, it focuses on that face. See “Using Face Detection” (📖 67) for more information.</p> <p>If more than one face is detected, the camera focuses on the face closest to the camera.</p> <p>When taking pictures of subjects other than people, or framing a subject with which no face is detected, the AF area mode setting switches to Auto, and the camera will automatically select the focus area (up to nine areas) containing the subject closest to the camera.</p>
 Auto	<p>The camera has nine focus areas, and automatically selects the focus areas containing the subject closest to the camera.</p> <p>Press the shutter-release button halfway to activate the focus area.</p> <p>When the shutter-release button is pressed halfway, the focus areas that are in focus (up to nine areas) selected by the camera will be displayed in the monitor.</p>
 Manual	<p>Select one of 99 focus areas in the monitor. This option is suited to situations in which the intended subject is relatively still and not positioned in the center of the frame. Rotate the multi-selector, or press ▲, ▼, ◀, or ▶ to move the focus area to where the subject is, and take a picture.</p> <p>To cancel focus area selection and adjust flash, macro mode, self-timer, and exposure compensation settings, press the  button. To return to the focus area selection screen, press the  button again.</p>

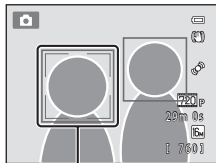

Focus area

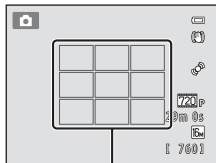

Focus areas

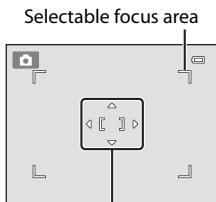

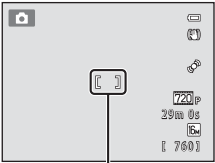

Focus area

The Shooting Menu (for (Auto) Mode)

Option	Description
 Center	<p>The camera focuses on the subject in the center of the frame. The focus area is always displayed in the center of the screen.</p>  <p>Focus area</p>

Notes About AF Area Mode

- When digital zoom is in effect, focus will be on the center of the screen regardless of the **AF area mode** setting.
- Some settings cannot be used with other functions ( 65).
- Autofocus may not perform as expected ( 29).

Autofocus Mode

Select  (auto) mode → MENU button →  tab → Autofocus mode

Select how the camera focuses when using subject tracking mode.

Option	Description
AF-S Single AF (default setting)	The camera focuses when the shutter-release button is pressed halfway.
AF-F Full-time AF	The camera focuses continuously until the shutter-release button is pressed down halfway. Use with moving subjects. The sound of lens drive movement will be heard while the camera focuses.

Notes About Autofocus Mode

Some settings cannot be used with other functions ( 65).

Autofocus Mode Setting

Autofocus mode can be set independently for both subject tracking mode and  (auto) mode.

Autofocus Mode for Movie Recording

Autofocus mode for movie recording can be set with **Autofocus mode** ( 53) in the movie menu.

The Smart Portrait Menu

- See “Changing the Image Size (Image Mode)” (📖 63) for information about **Image mode**.

Skin Softening

Select smart portrait mode → MENU button → 🗨️ tab → Skin softening

Enable skin softening.

Option	Description
↕ High	When the shutter is released, the camera detects one or more human faces (up to three), and processes the image to soften facial skin tones before saving the image. You can select the amount of effect that is applied.
↕ Normal (default setting)	
↕ Low	
OFF Off	Turns skin softening off.

The current setting can be confirmed by the indicator displayed in the monitor during shooting (📖 6). No indicator is displayed when **Off** is selected. The effects of skin softening are not visible when framing pictures for shooting. Check the degree of skin softening performed in playback mode.

Smile Timer

Select smart portrait mode → MENU button → 🗨️ tab → Smile timer

The camera detects human faces and then automatically releases the shutter whenever a smile is detected.



Option	Description
😊 On (default setting)	Enables smile timer.
OFF Off	Turns the smile timer off.

The current smile timer setting is indicated by an icon when shooting (📖 6). No icon is displayed when **Off** is selected.

Blink Proof

Select smart portrait mode → MENU button →  tab → Blink proof

The camera automatically releases the shutter twice each time a picture is taken. Of the two shots, one in which the subject's eyes are open is saved.

Option	Description
 On	<p>Enables blink warning. Flash cannot be used when On is selected.</p> <p>If the camera saved an image in which the subjects eyes may have been closed, the dialog shown on the right is displayed for a few seconds.</p> 
OFF Off (default setting)	Turns the blink warning off.

The current blink proof setting is indicated by an icon when shooting ( 6). No icon is displayed when **Off** is selected.

The Subject Tracking Menu

- See “Changing the Image Size (Image Mode)” (📖 63) for information about **Image mode**.

Autofocus Mode

Select subject tracking mode → MENU button →  tab → Autofocus mode

Determines how the camera focuses when using subject tracking mode.

Option	Description
AF-S Single AF	The camera focuses when the shutter-release button is pressed halfway.
AF-F Full-time AF (default setting)	Once a subject is registered for subject tracking, the camera continuously focuses until the shutter-release button is pressed halfway to lock the focus. The sound of lens drive movement can be heard.

- Changes made to the autofocus mode setting in this mode will not be applied to the autofocus mode setting in  (auto) mode.
- The autofocus mode setting applied in subject tracking mode is saved in the camera's memory even after the camera is turned off.

Face Priority Tracking

Select subject tracking mode → MENU button →  tab → Face priority tracking

Once the camera detects a person's face, it registers the subject and begins tracking that person.

Option	Description
On (default setting)	Enables face priority tracking.
Off	Disables face priority tracking. If a person whom you do not want to track is automatically registered, or when shooting non-human subjects, select Off if a person is in the frame.

The Playback Menu

- See “Editing Still Images” (📷10) for information about image editing features.

🖨️ Print Order (Creating a DPOF Print Order)

Press the  button (playback mode) → MENU button → Playback menu → 🖨️ Print order

When printing images saved on the memory card using any of the following methods, the **Print order** option in the playback menu is used to create digital “print orders” for printing on DPOF-compatible devices.

- Inserting the memory card into a DPOF-compatible (📷18) printer’s card slot.
- Taking the memory card to a digital photo lab.
- Connecting the camera to a PictBridge-compatible (📷18) printer (📷23). A print order can also be created for images saved in the internal memory if the memory card is removed from the camera.

1 Use the multi selector to select 🖨️ Print order and press the button.

- Proceed to step 3 when playing back in favorite pictures mode, auto sort mode or list by date mode.

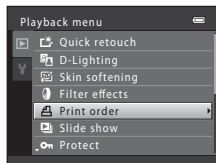

2 Select **Select images** and press the button.

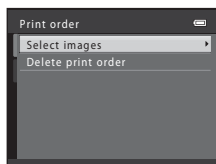

3 Select images (up to 99) and the number of copies (up to nine) of each.

- Rotate the multi selector, or press ◀ or ▶ to select images, and press ▲ or ▼ to specify the number of copies to be printed.
- Images selected for printing are indicated by the check mark icon and the numeral indicating the number of copies to be printed. If no copies have been specified for images, the selection is canceled.
- Rotate the zoom control to **T** (Q) to switch to full-frame playback. Rotate the zoom control to **W** (R) to switch back to 12-thumbnail display.
- Press the **OK** button when setting is complete.



4 Select whether or not to print shooting date and shooting information.

- Select **Date** and press the **OK** button to print the shooting date on all images in the print order.
- Select **Info** and press the **OK** button to print shooting information (shutter speed and aperture value) on all images in the print order.
- Select **Done** and press the **OK** button to complete the print order.

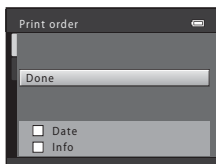

Images selected for printing are indicated by the  icon during playback.

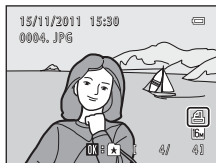

Notes About Print Order

When a print order is created in favorite pictures mode, auto sort mode, or list by date mode, the screen shown below is displayed if images other than those in the selected album, category, or shooting date have been marked for printing.

- If you select **Yes**, print order settings for other images are not changed and only the current print order settings are changed.
- Select **No** to remove print marking from previously marked images and restrict the print order to images in the selected category or captured on the selected shooting date.

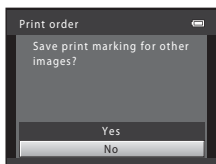

Favorite pictures mode or auto sort mode

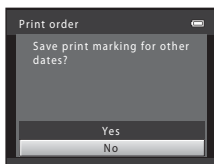

List by date mode

If the total number of the images in a print order exceeds 99, the screen shown below will be displayed.

- Select **Yes** to remove images previously added from the print order and restrict the print order to images just marked.
- Select **Cancel** to remove the images just added from the print order and restrict the print order to images previously marked.

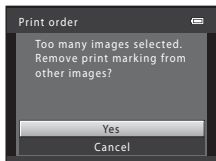

Favorite pictures mode or auto sort mode

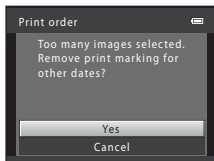

List by date mode

✔ Notes About Printing Shooting Date and Shooting Information

When the **Date** and **Info** settings are enabled in the print order option, shooting date and shooting information are printed on images when a DPOF-compatible (☎:18) printer that supports printing of shooting date and shooting information is used.

- Shooting information cannot be printed when the camera is connected to a DPOF-compatible printer via the included USB cable.
- Note that **Date** and **Info** settings are reset each time the **Print order** option is displayed.
- The date printed is that saved when the image was captured.
Changing the camera's date using the **Date and time** or **Time zone** in the **Time zone and date** option in the setup menu after an image has been captured has no effect on the date printed on the image.



✎ Canceling Existing Print Order

Select **Delete print order** in step 2 (☎:41) of “☎ Print Order (Creating a DPOF Print Order)” and press the **OK** button to remove print marking from all images and cancel the print order.

✎ Print Date

When shooting date and time are imprinted on images using the **Print date** option (☎:60) in the setup menu, images are saved with shooting date and time imprinted on the image when they are captured. Images with the date imprinted on them can be printed from printers that do not support printing of the date on images.



Only the date and time imprinted on images with the print date option will be printed, even if the **Print order** date option is enabled.

Slide Show

Press the  button (playback mode) → MENU button → Playback menu →  Slide show



Play back images, saved in the internal memory or on a memory card, one by one in an automated “slide show.”

1 Use the multi selector to select **Start** and press the button.

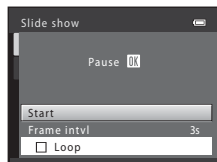
- To change the interval between images, select **Frame intvl**, select the desired interval time, and press the  button before selecting **Start**.
- To repeat the slide show automatically, select **Loop** and press the  button before selecting **Start**. The check mark () will be added to the loop option when enabled.





2 The slide show begins.

- While the slide show is in progress, press the multi selector  to display the next image or  to display the previous image. Hold down either button to fast forward or rewind.
- To end or pause the slide show, press the  button.



3 End the slide show or restart it.

- The screen shown on the right is displayed when the slide show has ended or is paused. Select  and press the  button to return to the playback menu. Select  to play the slide show again.



Notes About Slide Show

- Only the first frame of movies included in a slide show is displayed.
- The maximum playback time is up to 30 minutes even if **Loop** is enabled (.



Protect

Press the  button (playback mode) → MENU button → Playback menu →  Protect

Protects selected images from accidental deletion.

Select images to protect or cancel protection for previously protected images from the image selection screen. See “The Image Selection Screen” ( 47) for more information.

Note that formatting the camera’s internal memory or the memory card will permanently delete protected files ( 66).

Protected images are indicated by the  icon during playback ( 7).

The Image Selection Screen

When using one of the following features, a screen like that shown on the right is displayed when selecting images.

- Print order > **Select images** (👁️41)
- Protect (👁️46)
- Rotate image (👁️48)
- Copy > **Selected images** (👁️48)
- Welcome screen > **Select an image** (👁️54)
- Delete image > **Erase selected images** (📄 32)



Follow the procedures described below to select the images.

1 Rotate the multi selector, or press ◀ or ▶ to select an image.

- Rotate the zoom control (📄 2) to **T** (🔍) to switch to full-frame playback or **W** (📄) to switch back to 12-thumbnail display.
- Only one image can be selected for **Rotate image** and **Welcome screen**. Proceed to step 3.



2 Press ▲ or ▼ to select or deselect (or to specify the number of copies).



- When an image is selected, a check mark (✔️) is displayed with the image. Repeat steps 1 and 2 to select additional images.





3 Press the (OK) button to apply image selection.

- When **Selected images** is selected, a confirmation dialog is displayed. Follow the instructions displayed in the monitor.

Rotate Image

Press the  button (playback mode) → MENU button → Playback menu →  Rotate image

Specify the orientation in which saved images are displayed during playback. Still images can be rotated 90 degrees clockwise or 90 degrees counterclockwise. Images that were saved in portrait (“tall”) orientation can be rotated up to 180 degrees in either direction.

Select an image from the image selection screen (47). When the Rotate image screen is displayed, rotate the multi selector, or press  or  to rotate the image 90 degrees.

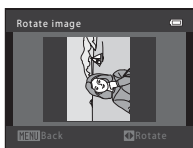

Rotate 90 degrees
counterclockwise

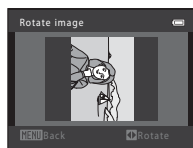



Rotate 90 degrees
clockwise

Press the  button to finalize display orientation, and save orientation information with the image.

Notes on Image Rotation

The camera cannot rotate images captured with another make or model of digital camera.

Voice Memo



Press the  button (playback mode) → select an image → MENU button → Playback menu →  Voice memo

Use the camera's microphone to record voice memos for images.

When you select an image with a voice memo attached, you can play back the voice memo.



- If you select an image that has no voice memo, the voice memo recording screen is displayed; if you select an image that has a voice memo (i.e., an image indicated by  in full-frame playback mode), the voice memo playback screen is displayed.

Recording Voice Memos

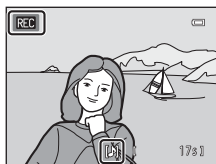
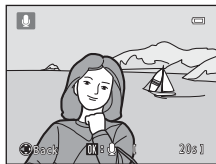
- Press and hold the  button to record a voice memo (up to 20 seconds).
- Do not touch the microphone during recording.
- During recording, **REC** and  blink in the monitor.
- When recording ends, the voice memo playback screen is displayed. See “Playing Voice Memos” for more information.
- Press the multi selector  before or after recording a voice memo to return to the playback menu. Press the **MENU** button to exit the playback menu.



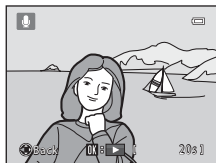

Playing Voice Memos

- Press the  button to play the voice memo.
- Press the  button again to stop playback.
- Rotate the zoom control to **T** or **W** during playback to adjust playback volume.
- Press the multi selector  before or after recording a voice memo to return to the playback menu. Press the **MENU** button to exit the playback menu.



Deleting Voice Memos

Press the  button while the screen described in “Playing Voice Memos” is displayed.

When the confirmation dialog is displayed, select **Yes** and press the  button. Only the voice memo will be deleted.

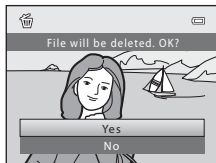

Notes About Voice Memos

- When an image with a voice memo attached is deleted, both the image and its voice memo are deleted.
- You cannot delete voice memos attached to protected images (46).
- Voice memos cannot be recorded for an image that already has a voice memo attached to it. The current voice memo must be deleted before a new voice memo can be recorded.
- This camera cannot record voice memos for images captured with another make or model of digital camera.

More Information



See “File and Folder Names” (77) for more information.

Copy (Copy Between Internal Memory and Memory Card)

Press the  button (playback mode) → MENU button → Playback menu →  Copy

Copy images between the internal memory and a memory card.

1 Use the multi selector to select a destination option to which images are copied and press the  button.

- : Copy images from internal memory to memory card.
- : Copy images from memory card to internal memory.

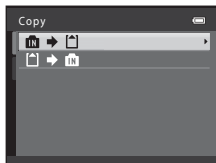



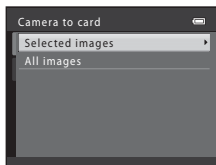

2 Select a copy option and press the  button.

- **Selected images:** Copy images selected from the image selection screen (47).
- **All images:** Copy all images.



Notes About Copying Images

- JPEG-, MOV-, and WAV-format files can be copied. Files saved in any other format cannot be copied.
- If voice memos (49) are attached to images selected for copying, voice memos are copied with the images.
- Operation is not guaranteed with images captured with another make of camera or that have been modified on a computer.
- When copying images for which **Print order** (41) options are enabled, the print order settings are not copied. However, when copying images for which **Protect** (46) is enabled, the protect setting is copied.
- Images or movies copied from the internal memory or a memory card cannot be displayed in auto sort mode (7).
- If an image added to an album (4) is copied, the copied image is not added to the album.

If “Memory contains no images.” Is Displayed

If a memory card that contains no images is inserted into the camera, **Memory contains no images.** will be displayed when the camera is switched to playback mode. Press the MENU button to display the copy options screen, and copy the images saved in the camera’s internal memory to the memory card.

More Information

See “File and Folder Names” (77) for more information.



The Movie Menu

Movie Options

Enter shooting mode → MENU button →  tab → Movie options

Select the desired movie option to record.

Larger image sizes and faster movie bitrates mean greater image quality and larger movie file sizes.

Option	Description
 HD 720p (1280×720) (default setting)	Movies with an aspect ratio of 16:9 are recorded. <ul style="list-style-type: none">• Movie bitrate: 9.1 Mbps
 iFrame 540 (960×540)	Movies with an aspect ratio of 16:9 are recorded. A format supported by Apple Inc. <ul style="list-style-type: none">• Movie bitrate: 20 Mbps When recording movies to the internal memory, recording may stop unexpectedly in some shooting conditions. When recording movies of important events, recording to a memory card (class 6 or higher) is recommended.
 VGA (640×480)	Movies with an aspect ratio of 4:3 are recorded. <ul style="list-style-type: none">• Movie bitrate: 3.1 Mbps

- The movie bitrate is the volume of movie data recorded per second. Variable bitrate (VBR) encoding is used to automatically adjust the bitrate depending on the subject being recorded. When recording movies of subjects with large amounts of motion, the file size increases.
- The frame rate is approximately 30 frames per second for all options.
- For information about recording time, see  84.

More Information

See "File and Folder Names" ( 77) for more information.

Autofocus Mode

Enter shooting mode → MENU button →  tab → Autofocus mode

Select how the camera focuses in movie mode.

Option	Description
AF-S Single AF (default setting)	Focus is locked when the ● () button is pressed to start recording. Select this option when the distance between the camera and the subject will remain fairly consistent.
AF-F Full-time AF	Camera focuses continuously. Select this option when the distance between the camera and subject will change significantly during recording. The sound of the camera focusing may be heard in the recorded movie. Use of Single AF is recommended to prevent the sound of the camera focusing from interfering with recording.

Wind Noise Reduction

Enter shooting mode → MENU button →  tab → Wind noise reduction

Allows you to reduce wind noise during movie recording.

Option	Description
 On	Reduces the sound heard when wind passes over the microphone. Use when recording movies in locations with strong winds. Other sounds may become difficult to hear during playback.
OFF Off (default setting)	Wind noise reduction is not enabled.

The current wind noise reduction setting is indicated by an icon when shooting ( 6). No icon is displayed when **Off** is selected.

The Setup Menu

Welcome Screen

MENU button → Y tab → Welcome screen









Select whether or not a welcome screen is displayed when the camera is turned on.

Option	Description
None (default setting)	The camera enters shooting or playback mode without displaying the welcome screen.
COOLPIX	The camera displays a welcome screen and enters shooting or playback mode.
Select an image	Displays an image selected for the welcome screen. When the image selection screen is displayed, select an image (📷47) and press the OK button. <ul style="list-style-type: none">As the selected image is saved by the camera, it will be displayed when the camera is turned on even if the original image is deleted.Images captured at an Image mode (📖 63) setting of 16:9 4608×2592, and copies created at a size of 320 × 240 or smaller using the small picture (📷18) or crop (📷19) function, cannot be selected.

Time Zone and Date

MENU button →  tab → Time zone and date

Set the camera clock.

Option	Description
Date and time	<p>Set camera clock to current date and time.</p> <p>Use the multi selector to set the date and time in the date screen.</p> <ul style="list-style-type: none"> • Select an item: Press  or  (changes between D, M, Y, hour, minute). • Edit the highlighted item: Rotate the multi selector, or press  or . • Apply the setting: Select the minute setting and press the .
Date format	<p>The available date formats are Year/Month/Day, Month/Day/Year, and Day/Month/Year.</p>
Time zone	<p> Home time zone can be specified and daylight saving time can be enabled or disabled. When the travel destination () is selected, the time difference (57) between the travel destination and the home time zone () is automatically calculated and the date and time in the selected region are saved. This can be useful when travelling.</p>

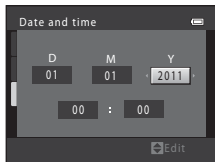

Selecting the Travel Destination Time Zone

1 Use the multi selector to select **Time zone** and press the .

- The **Time zone** screen is displayed.

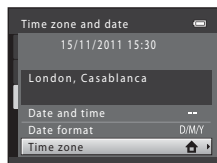

2 Select  **Travel destination** and press the .

- The date and time displayed in the monitor changes according to the region currently selected.

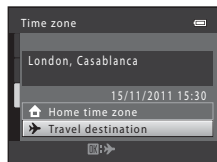

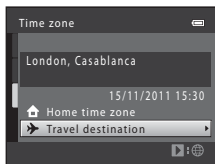

3 Press **▶**.

- The travel destination screen is displayed.



4 Press **◀** or **▶** to select the travel destination time zone.

- If daylight saving time is in effect, press **▲** to enable daylight saving time function.  is displayed at the top of the monitor and the camera clock is advanced one hour. Press **▼** to disable the daylight saving time function.
- Press the **OK** button to apply the travel destination time zone.
- While the travel destination time zone is selected, the  icon will be displayed in the monitor when the camera is in shooting mode.

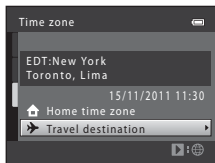
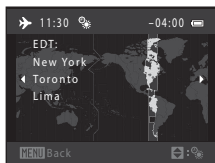

Home Time Zone

- To switch to the home time zone, select **Home time zone** in step 2 and press the **OK** button.
- To change the home time zone, select **Home time zone** in step 2, and complete steps 3 and 4.

Daylight Saving Time

When daylight saving time starts or ends, turn the daylight saving time function on or off from the time zone selection screen displayed in step 4.

Imprinting Date on Images

Enable date imprint from the **Print date** option (60) in the setup menu after the date and time have been set. When the **Print date** option is enabled, images will be saved with shooting date imprinted on them.

Time Zones

The camera supports the time zones listed below.

For time zones not listed below, set the camera clock to local time from the **Date and time** option.

UTC +/-	Location	UTC +/-	Location
-11	Midway, Samoa	+1	Madrid, Paris, Berlin
-10	Hawaii, Tahiti	+2	Athens, Helsinki, Ankara
-9	Alaska, Anchorage	+3	Moscow, Nairobi, Riyadh, Kuwait, Manama
-8	PST (PDT): Los Angeles, Seattle, Vancouver	+4	Abu Dhabi, Dubai
-7	MST (MDT): Denver, Phoenix	+5	Islamabad, Karachi
-6	CST (CDT): Chicago, Houston, Mexico City	+5.5	New Delhi
-5	EST (EDT): New York, Toronto, Lima	+6	Colombo, Dhaka
-4.5	Caracas	+7	Bangkok, Jakarta
-4	Manaus	+8	Beijing, Hong Kong, Singapore
-3	Buenos Aires, Sao Paulo	+9	Tokyo, Seoul
-2	Fernando de Noronha	+10	Sydney, Guam
-1	Azores	+11	New Caledonia
±0	London, Casablanca	+12	Auckland, Fiji

Monitor Settings

MENU button →  tab → Monitor settings

Set the options below.



Option	Description
Photo info	Select information displayed in the monitor during shooting and playback. See "Photo Info" ( 59) for more information.
Image review	This setting determines whether or not the captured image is displayed immediately after shooting. The default setting is On .
Brightness	Select from five settings for monitor brightness. The default setting is 3 .

Photo Info

Select whether or not the photo information is displayed in the monitor.
See "The Monitor" (📖 6) for information about indicators displayed in the monitor.

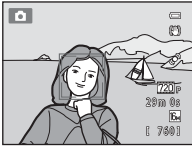
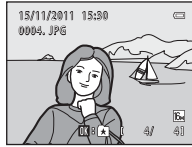

	Shooting mode	Playback mode
Show info		
Auto info (default setting)	Current settings and operational guides are displayed as in Show info above. If no operations are performed for a few seconds, the display changes to that with Hide info . Information will be displayed again when the next operation is performed.	
Hide info		
Framing grid+auto info		
	In addition to information shown with Auto info above, a framing grid is displayed to help frame pictures. It is not displayed when recording movies.	The current settings or operation guide is displayed, as in Auto info above.
Movie frame+auto info		
	In addition to information shown with Auto info above, a frame is displayed before recording begins that represents the area that will be captured when recording movies. It is not displayed when recording movies.	The current settings or operation guide is displayed, as in Auto info above.

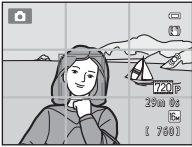
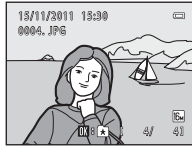
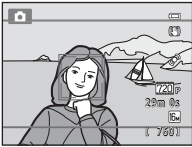
Print Date (Imprinting Date and Time)

MENU button →  tab → Print date



Allows you to imprint the shooting date and time on images at the time of shooting. Because this feature imprints the shooting date and time permanently in images, this feature also allows you to include the shooting date and time when printing images, even if your printer does not support the printing of dates on images (44).



Option	Description
 Date	Date is imprinted on images.
 Date and time	Date and time are imprinted on images.
OFF Off (default setting)	Date and time are not imprinted on images.

The current print date setting is indicated by an icon when shooting ( 6). No icon is displayed when **Off** is selected.

Notes About Print Date

- Imprinted dates form a permanent part of image data and cannot be deleted. The date and time cannot be imprinted on images after they have been captured.
- The date cannot be imprinted in the following situations:
 - Images captured in **Panorama assist** scene mode
 - Movies
- Dates imprinted at an **Image mode** setting ( 63) of **VGA 640×480** may be difficult to read. Select an **Image mode** setting of **PC 1024×768** or larger when using print date.
- The date is saved using the format selected in the setup menu's **Time zone and date** item ( 22, 55).

Print Date and Print Order

When printing with a DPOF-compatible printer that can print the shooting date and shooting information, you can use the **Print order** option (41) to print this information in images, even if the **Print date** function was set to **Off** at the time of shooting.

Vibration Reduction

MENU button →  tab → Vibration reduction

Reduce the effects of camera shake while shooting. Vibration reduction effectively reduces blur, caused by slight hand movement known as camera shake, which commonly occurs when shooting with zoom applied or at slow shutter speeds. The effects of camera shake are reduced when recording movies, in addition to when taking still pictures.

Set **Vibration reduction** to **Off** when using a tripod to stabilize the camera during shooting.

Option	Description
 On (default setting)	Vibration reduction is enabled.
OFF Off	Vibration reduction is disabled.

The current vibration reduction setting is indicated by an icon when shooting ( 6). No icon is displayed when **Off** is selected.













Notes About Vibration Reduction

- After turning on the camera or after switching from playback mode to shooting mode, wait for the shooting mode screen to be displayed completely before taking pictures.
- Due to characteristics of the vibration reduction function, images displayed in the camera's monitor immediately after shooting may be displayed blurry.
- Vibration reduction may be unable to completely eliminate the effects of camera shake in some situations.

Motion Detection

MENU button →  tab → Motion detection

Enable motion detection to reduce the effects of subject movement and camera shake when shooting still images.

Option	Description
 Auto (default setting)	<p>When the camera detects subject movement or camera shake, the ISO sensitivity and shutter speed are automatically increased to reduce blurring. However, motion detection does not function in the following situations:</p> <ul style="list-style-type: none"> • When the flash fires • In  (auto) mode, when ISO sensitivity ( 33) is set to any setting other than Auto • In  (auto) mode, when Continuous is set to Multi-shot 16 () • In the following scene modes: Sports ( 41), Night portrait ( 41), Dusk/dawn ( 42), Night landscape ( 42), Museum ( 44), Fireworks show ( 44), and Backlighting ( 44) • When subject tracking mode is selected
OFF Off	Motion detection is disabled.

The current motion detection setting is indicated by an icon when shooting ( 6). When the camera detects camera shake or subject movement, it increases shutter speed and the motion detection icon turns green. No icon is displayed when **Off** is selected.

Notes About Motion Detection

- Motion detection may be unable to completely eliminate the effects of subject movement and camera shake in some situations.
- Motion detection may not function if the subject exhibits significant movement or is too dark.
- The images captured using motion detection may be somewhat “grainy” in appearance.

AF Assist

MENU button →  tab → AF assist

Enable or disable AF-assist illuminator, which assists autofocus operation when the subject is dimly lit.

Option	Description
Auto (default setting)	AF-assist illuminator will be used to assist the focus operation when the subject is dimly lit. The illuminator has a range of about 1.9 m (6 ft 2 in.) at the maximum wide-angle position and about 1.1 m (3 ft 7 in.) at the maximum telephoto position. Note that for some scene modes (such as Museum (📖 44) and Pet portrait (📖 46)) or focus areas, the AF-assist illuminator may not light even when Auto is selected.
Off	AF-assist illuminator does not light. The camera may be unable to focus under dim lighting.

Digital Zoom

MENU button →  tab → Digital zoom

Enable or disable digital zoom.

Option	Description
On (default setting)	When the camera is zoomed in to the maximum optical zoom position, rotating the zoom control to T (📷) triggers digital zoom (📖 27).
Off	Digital zoom will not be activated.

Notes About Digital Zoom

- When digital zoom is in effect, the camera focuses at the center of the frame.
- Digital zoom cannot be used in the following situations.
 - When **Scene auto selector**, **Portrait**, **Night portrait**, or **Pet portrait** is selected in scene mode
 - When smart portrait mode is selected
 - When subject tracking mode is selected
 - When **Continuous** is set to **Multi-shot 16**

Sound Settings

MENU button →  tab → Sound settings

Adjust the following sound settings.

Option	Description
Button sound	Select On (default setting) or Off . When On is selected, a beep will sound once when operations are completed successfully, twice when the camera acquires focus on the subject, and three times when an error is detected. Start-up sound will also play when the camera is turned on.
Shutter sound	Select On (default setting) or Off . The shutter sound is not heard, even if On is selected, when using Continuous , BSS , or Multi-shot 16 () or when recording movies.

Notes About Sound Settings

Button sounds and the shutter sound are not heard when using the **Pet portrait** scene mode.



Auto Off

MENU button →  tab → Auto off

If no operations are performed for a specified amount of time, the monitor turns off and the camera enters standby mode ( 21).

This setting determines the amount of time that passes before the camera enters standby mode. You can select **30 s**, **1 min** (default setting), **5 min**, or **30 min**.

When the Monitor Has Turned Off to Save Power

- When the camera is in standby mode, the power-on lamp blinks.
- If no operations are performed for approximately another three minutes, the camera will turn off automatically.
- When the power-on lamp is blinking, pressing any of the following buttons will turn the monitor back on:
Power switch, shutter-release button,  button,  button, or  (movie-record) button

Notes About Auto Off

The time that passes before the camera enters standby mode is fixed in the following situations:

- When a menu is displayed: 3 minutes
- During slide show playback: Up to 30 minutes
- When the AC adapter EH-62F is connected: 30 minutes

Format Memory/Format Card

MENU button →  tab → Format memory/Format card

Use this option to format the internal memory or a memory card.

Formatting the internal memory or memory cards permanently deletes all data. Data that has been deleted cannot be restored. Be sure to transfer important images to a computer before formatting.

Formatting the Internal Memory

To format the internal memory, remove the memory card from the camera. The **Format memory** option is displayed in the setup menu.

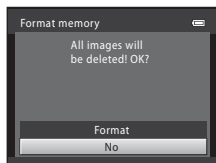

Formatting Memory Cards

When a memory card is inserted in the camera, the **Format card** option is displayed in the setup menu.

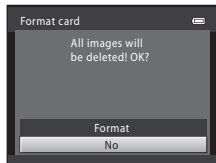

Notes About Formatting Internal Memory and Memory Cards

- Album icon settings () are reset to their default settings (number icons) when the internal memory or memory card is formatted.
- Do not turn the camera off or open the battery-chamber/memory card slot cover during formatting.
- The first time you insert a memory card that has been used in another device into this camera, be sure to format it with this camera.

Language

MENU button →  tab → Language

Select one of 29 languages for display of camera menus and messages.

Čeština	Czech
Dansk	Danish
Deutsch	German
English	(default setting)
Español	Spanish
Ελληνικά	Greek
Français	French
Indonesia	Indonesian
Italiano	Italian
Magyar	Hungarian
Nederlands	Dutch
Norsk	Norwegian
Polski	Polish
Português (BR)	Brazilian Portuguese
Português (PT)	European Portuguese

Русский	Russian
Română	Romanian
Suomi	Finnish
Svenska	Swedish
Tiếng Việt	Vietnamese
Türkçe	Turkish
Українська	Ukrainian
عربي	Arabic
简体中文	Simplified Chinese
繁體中文	Traditional Chinese
日本語	Japanese
한글	Korean
ภาษาไทย	Thai
हिन्दी	Hindi

TV Settings

MENU button →  tab → TV settings

Adjust settings for connection to a TV.

Option	Description
Video mode	Select from NTSC and PAL .
HDMI	Select a resolution for HDMI output from Auto (default setting), 480p , 720p , or 1080i . When Auto is selected, the option best suited to the TV to which the camera is connected is automatically selected from 480p , 720p , or 1080i .
HDMI device control	Select whether or not the camera can receive signals from a TV that supports the HDMI-CEC standard when it is connected to the TV via HDMI. When On (default setting) is selected, the TV's remote control can be used to control the camera during playback. See "Using a TV Remote Control (HDMI Device Control)" ()22) for more information.



HDMI and HDMI-CEC

HDMI (High-Definition Multimedia Interface) is a multimedia interface. HDMI-CEC (HDMI-Consumer Electronics Control) allows compatible devices to inter-operate.

Charge by Computer

MENU button →  tab → Charge by computer



Select whether or not the battery inserted into the camera is charged when the camera is connected to a computer via the USB cable ( 74).

Option	Description
Auto (default setting)	When the camera is connected to a computer that is running, the battery inserted into the camera is automatically charged using power supplied by the computer.
Off	The battery inserted into the camera is not charged when the camera is connected to a computer.

Notes About Connecting the Camera to a Printer

- The battery cannot be charged with connection to a printer, even if the printer complies with the PictBridge standard.
- When **Auto** is selected for **Charge by computer**, it may be impossible to print images with direct connection of the camera to some printers. If the PictBridge startup screen is not displayed in the monitor after the camera is connected to a printer and turned on, turn the camera off and disconnect the USB cable. Set **Charge by computer** to **Off** and reconnect the camera to the printer.

Notes About Charging with Connection to a Computer

- The battery cannot be charged, nor can data be transferred, when the camera is connected to a computer before the camera's display language and date and time have been set ( 22). If the camera's clock battery ( 23) has been exhausted, the date and time must be reset before the battery can be charged or images can be transferred with connection to a computer. In this case, use the Charging AC Adapter EH-69P ( 16) to charge the battery and then set the camera's date and time.
- If the camera is turned off, charging will also stop.
- If the computer enters sleep mode while charging, charging will stop and the camera may be turned off.
- When disconnecting the camera from the computer, turn the camera off and then disconnect the USB cable.
- About 3 hours and 50 minutes are required to charge a fully exhausted battery. Charging time increases when images are transferred while the battery is charging.
- When the camera is connected to a computer, an application installed on the computer, such as Nikon Transfer 2, may start. If the camera was connected to the computer for the sole purpose of charging the battery, exit the application.
- The camera turns off automatically if there is no communication with the computer for 30 minutes after the battery has finished charging.
- Depending upon computer specifications, settings, and power supply and allocation, it may be impossible to charge the battery using a computer connection while it is inserted into the camera.

The Charge Lamp



The following chart explains charge lamp status when the camera is connected to a computer.

Charge lamp	Description
Blinks slowly (green)	Battery charging.
Off	Battery not charging. If the charge lamp changes from slow blinking (green) to off while the power-on lamp is lit, charging is complete.
Flickers (green)	<ul style="list-style-type: none">• The ambient temperature is not suited to charging. Charge the battery indoors with an ambient temperature of 5 °C to 35 °C (41 °F to 95 °F).• The USB cable is not connected correctly, or the battery is faulty. Make sure the USB cable is connected correctly and replace the battery if necessary.• The computer is in sleep mode and is not supplying power. Wake up the computer.• The battery cannot be charged because the computer cannot supply power to the camera, due to the computer's settings or its specifications.

Blink Warning

MENU button →  tab → Blink warning

Select whether or not the camera detects human subjects that have blinked using face detection (📖 67) when shooting in the following modes:

-  (auto) mode (when **Face priority** (35) is selected for AF area mode option)
- **Scene auto selector** (📖 40), **Portrait** (📖 40), or **Night portrait** (📖 41) scene mode

Option	Description
On	When the camera detects that one or more human subjects may have blinked in an image captured using face detection, the Did someone blink? screen is displayed in the monitor. The face of the human subject that may have blinked when the shutter was released is framed by a yellow border. Should this occur, check the image and determine whether or not another image should be captured. See “The Blink Warning Screen” ( 72) for more information.
Off (default setting)	Blink warning is disabled.

Notes About Blink Warning







The blink warning does not function at continuous settings of **Continuous**, **BSS**, or **Multi-shot 16**.

The Blink Warning Screen

When the **Did someone blink?** screen shown on the right is displayed in the monitor, the operations described below are available.

If no operations are performed within a few seconds, the camera automatically returns to shooting mode.





Function	Control	Description
Enlarge the detected face that blinked	T (Q)	Rotate the zoom control to T (Q).
Switch to full-frame playback	W (checkered flag)	Rotate the zoom control to W (checkered flag).
Select the face to be displayed		If the camera detects that more than one human subject blinked, press ◀ or ▶ to switch the display to another face.
Delete the image		Press the  button.
Switch to shooting mode		Press the  button or the shutter-release button.
		

Filmstrip

MENU button →  tab → Filmstrip

Allows you to select whether or not the filmstrip is displayed when you rotate the multi selector quickly in full-frame playback mode ( 30).

Option	Description
On	<p>Image thumbnails are displayed in the bottom of the monitor when you rotate the multi selector quickly while viewing an image in full-frame playback mode.</p> <p>You can view thumbnails of previous and subsequent images, and select an image.</p> <p>While the filmstrip is displayed, you can hide it by pressing the  button.</p> 
Off (default setting)	Disables the filmstrip.

Notes About Filmstrip Display





- The filmstrip is not displayed in the following situations:
 - When using favorite pictures mode
 - When using auto sort mode
 - When using list by date mode
- In order to display the filmstrip, at least ten images must be saved in the camera's internal memory or on the memory card.

Reset All









MENU button →  tab → Reset all

When **Reset** is selected, the camera's settings will be restored to their default values.





Basic Shooting Functions

Option	Default value
Flash mode ( 56)	Auto
Self-timer ( 58)	Off
Macro mode ( 59)	Off
Exposure compensation ( 60)	0.0

Shooting Menu

Option	Default value
Image mode ( 63)	 4608 × 3456
White balance ( 30)	Auto
Continuous ( 32)	Single
ISO sensitivity ( 33)	Auto
Color options ( 34)	Standard color
AF area mode ( 35)	Face priority
Autofocus mode ( 37)	Single AF

Scene Mode

Option	Default value
Scene mode setting in the shooting-mode selection menu ( 39)	Scene auto selector
Hue adjustment in Food mode ( 43)	Center
Continuous shooting in pet portrait mode ( 46)	Continuous
Pet portrait auto release in pet portrait mode ( 46)	On

Special effects mode

Option	Default value
Special effects mode setting in the shooting-mode selection menu ( 47)	Soft

Smart Portrait Menu

Option	Default value
Skin softening (📷38)	Normal
Smile timer (📷38)	On
Blink proof (📷39)	Off

Subject Tracking Menu

Option	Default value
Autofocus mode (📷40)	Full-time AF
Face priority tracking (📷40)	On

Movie Menu

Option	Default value
Movie options (📷52)	HD 720p (1280 × 720)
Autofocus mode (📷53)	Single AF
Wind noise reduction (📷53)	Off

Setup Menu

Option	Default value
Welcome screen (📷54)	None
Photo info (📷58)	Auto info
Image review (📷58)	On
Brightness (📷58)	3
Print date (📷60)	Off
Vibration reduction (📷61)	On
Motion detection (📷62)	Auto
AF assist (📷63)	Auto
Digital zoom (📷63)	On
Button sound (📷64)	On
Shutter sound (📷64)	On
Auto off (📷65)	1 min
HDMI (📷68)	Auto
HDMI device control (📷68)	On

The Setup Menu

Charge by computer (Fn69)	Auto
Blink warning (Fn71)	Off
Filmstrip (Fn73)	Off

Others

Option	Default value
Paper size (Fn26, Fn27)	Default
Frame interval for Slide show (Fn45)	3 s
Album icons (Fn6)	Number icons (black)

- Selecting **Reset all** also clears the current file number (Fn77) from memory. Numbering will continue from the lowest number available. To reset file numbering to "0001", delete all images saved in the internal memory or on the memory card (32) before selecting **Reset all**.
- The following menu settings will remain unaffected when menus are reset with **Reset all**.
Shooting menu: Preset manual data (Fn31) acquired for **White balance**
Setup menu: **Time zone and date** (Fn55), **Language** (Fn67), and **Video mode** (Fn68) under **TV settings**

Firmware Version

MENU button → Y tab → Firmware version

View the current camera firmware version.

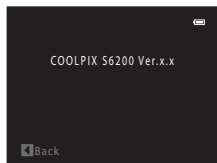

File and Folder Names

Images, movies, or voice memos are assigned file names as follows.

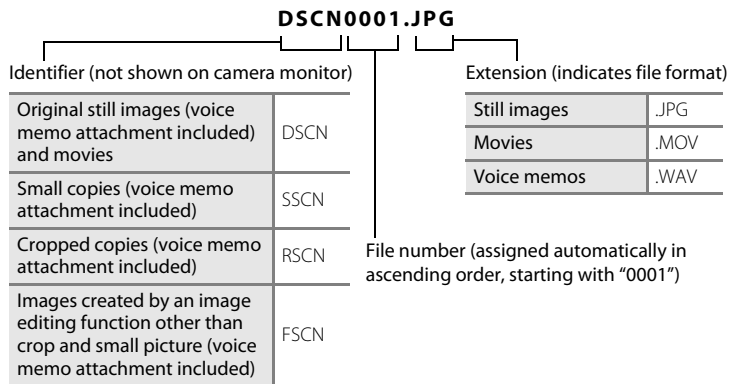

- Files are saved in folders named with a folder number followed by an identifier: "P_" plus a three-digit sequential number for images captured in **Panorama assist** scene mode (e.g. "101P_001"; 2) and "NIKON" for all other images (e.g. "100NIKON"). When the number of files within a folder reaches 9999, a new folder will be created. File numbers will be assigned automatically starting with "0001".
- Voice memo file names have the same identifier and file number as the image to which the voice memo is attached.
- Files copied using **Copy>Selected images** are copied to the current folder, where they are assigned new file numbers in ascending order starting from the largest file number in memory. **Copy>All images** copies all folders from the source medium; file names do not change but new folder numbers are assigned in ascending order, starting from the largest folder number on the destination medium (51).
- A single folder can hold up to 200 images; if the current folder already contains 200 images, a new folder, named by adding one to the current folder name, will be created the next time an image is captured. If the current folder is numbered 999 and contains 200 images, or an image is numbered 9999, no further images can be captured until the internal memory or memory card is formatted (66), or a new memory card is inserted.



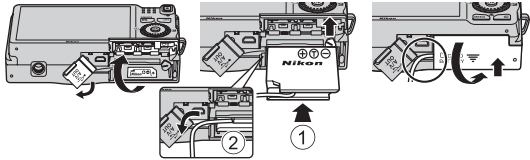









Optional Accessories

Rechargeable battery	Rechargeable Li-ion Battery EN-EL12 ¹
Charging AC adapter	Charging AC Adapter EH-69P ^{1,2}
Battery charger	Battery Charger MH-65 ²
AC adapter	<p>AC Adapter EH-62F (connect as shown)</p>  <p>Be sure that the power connector cord has been properly aligned in power connector and battery chamber grooves before closing the battery-chamber/memory card slot cover. If part of the cord runs out of the grooves, the cover or cord may be damaged when the cover is closed.</p>
USB cable	USB Cable UC-E6 ¹
Audio/video cable	Audio Video Cable EG-CP16 ¹

















¹ Included with the camera at the time of purchase (📖 ii).

























² When using in other countries, use a plug adapter (commercially available) as necessary. For more information about plug adapters, consult your travel agency.

Error Messages

















Display	Problem	Solution	
 (blinks)	Clock not set.	Set date and time.	 55
 Battery exhausted.	Battery exhausted.	Charge or replace battery.	14, 16
 Battery temperature high	Battery temperature is high.	Turn off camera, and allow battery to cool down before resuming use. After five seconds, this message will disappear, the monitor will turn off, and the power-on lamp will blink rapidly. After the lamp blinks for three minutes, the camera will turn off automatically. Pressing the power switch also turns off the camera.	21
 (● blinks red)	Camera cannot focus.	<ul style="list-style-type: none"> • Refocus. • Use focus lock. 	28, 29 70
 Please wait for the camera to finish recording.	Camera cannot perform other operations until saving is complete.	Wait until message clears from display automatically when saving is complete.	–
 Memory card is write protected.	Write-protect switch is in “lock” position.	Slide write-protect switch to “write” position.	–
 This card cannot be used.	Error accessing memory card.	<ul style="list-style-type: none"> • Use approved card. • Check that terminals are clean. • Confirm that memory card is correctly inserted. 	19 18
 This card cannot be read.			18
 Card is not formatted. Format card? Yes No	Memory card has not been formatted for use in COOLPIX S6200.	Formatting deletes all data saved on the memory card. Be sure to select No and make copies of any images which need to be kept before formatting the memory card. Select Yes and press the  button to format the memory card.	 5

Error Messages

Display	Problem	Solution	
 Out of memory.	Memory card is full.	<ul style="list-style-type: none"> Select smaller image size. Delete images. Insert new memory card. Remove memory card and use internal memory. 	63 32, 86 18 19
 Image cannot be saved.	Error occurred while saving image.	Format internal memory or memory card.	 66
	Camera has run out of file numbers.	Insert a new memory card or format internal memory or memory card.	 77
	Image cannot be used for welcome screen.	<p>The following images cannot be registered as welcome screen.</p> <ul style="list-style-type: none"> Images captured at an Image mode setting of  4608x2592 Images reduced to 320 x 240 size or smaller with cropping or small image editing 	 54
	Insufficient space to save a copy.	Delete images from destination.	32
 Album is full. No further pictures can be added.	200 images have already been added to album.	<ul style="list-style-type: none"> Remove some images from album. Add to other albums. 	 5  4
 Sound file cannot be saved.	A voice memo cannot be attached to this file.	<ul style="list-style-type: none"> Voice memos cannot be attached to movies. Select an image captured with this camera. 	–  49
 A blink was detected in the picture just taken.	One or more portrait subjects may have blinked when the picture was taken.	Check the image in playback mode.	30, 50
 Image cannot be modified.	Cannot edit selected image.	<ul style="list-style-type: none"> Select images that support editing function. Movies cannot be edited. 	 11 –
 Cannot record movie.	Time out error while saving movie on the memory card.	Select memory card with faster write speed.	18

Display	Problem	Solution																		
 Memory contains no images.	No images in the internal memory or memory card.	<ul style="list-style-type: none"> Remove the memory card from the camera to play back images saved in the camera's internal memory. To copy image from internal memory to memory card, press the MENU button. The copy screen will be displayed and images in the internal memory can be copied to memory card. 	18  51																	
	No images have been added to the selected album.	<ul style="list-style-type: none"> Add images to the album. Select an album to which images are added. 	 4  5																	
	No images are contained in the category selected in auto sort mode.	Select the category containing the sorted images.	 7																	
 File contains no image data.	File not created with this camera.	File cannot be viewed on this camera. View file using a computer or the devices used to create or edit this file.	–																	
 This file cannot be played back.				 All images are hidden.	No images available for a slide show.	–	 45	 This image cannot be deleted.	Image is protected.	Disable protection.	 46	 Travel destination is in the current time zone.	Destination in same time zone as home.	–	 57	Lens error 	Lens error.	Turn camera off and then on again. If error persists, contact retailer or Nikon-authorized service representative.	20	 Communications error
 All images are hidden.	No images available for a slide show.	–	 45																	
 This image cannot be deleted.	Image is protected.	Disable protection.	 46																	
 Travel destination is in the current time zone.	Destination in same time zone as home.	–	 57																	
Lens error 	Lens error.	Turn camera off and then on again. If error persists, contact retailer or Nikon-authorized service representative.	20																	
 Communications error	Error occurred during communication with printer.	Turn camera off and reconnect USB cable.	 24																	

Error Messages

Display	Problem	Solution	
System error 	Error has occurred in camera's internal circuitry.	Turn camera off, remove and reinsert battery, and turn camera on. If error persists, contact retailer or Nikon-authorized service representative.	14, 21
 Printer error: check printer status.	Printer error.	Check printer. After solving the problem, select Resume and press the  button to resume printing.*	–
 Printer error: check paper	Specified size of paper is not loaded in printer.	Load the specified paper size, select Resume , and press the  button to resume printing.*	–
 Printer error: paper jam	Paper has jammed in printer.	Remove the jammed paper, select Resume , and press the  button to resume printing.*	–
 Printer error: out of paper	No paper is loaded in printer.	Load the specified paper size, select Resume , and press the  button to resume printing.*	–
 Printer error: check ink	Ink error.	Check ink, select Resume , and press the  button to resume printing.*	–
 Printer error: out of ink	Running out of ink or ink cartridge is empty.	Replace ink cartridge, select Resume , and press the  button to resume printing.*	–
 Printer error: file corrupt	An error caused by the image file has occurred.	Select Cancel and press the  button to cancel printing.	–

* See the documentation provided with your printer for further guidance and information.



Technical Notes and Index

Caring for the Product	2
The Camera.....	2
The Battery.....	4
Charging AC Adapter.....	5
Memory Cards.....	5
Cleaning and Storage	6
Cleaning.....	6
Storage.....	6
Troubleshooting	7
Specifications	14
Supported Standards.....	18
Index	19

Caring for the Product

The Camera

To ensure continued enjoyment of this Nikon product, observe the following precautions when using or storing the device.

Do Not Drop

The product may malfunction if subjected to strong shock or vibration.

Handle the Lens and All Moving Parts with Care

Do not apply force to the lens, lens cover, monitor, memory card slot, or battery chamber. These parts are easily damaged. Applying force to the lens cover could result in camera malfunction or damage to the lens. Should the monitor break, care should be taken to avoid injury caused by broken glass and to prevent the liquid crystal from the display touching the skin or entering the eyes or mouth.

Keep Dry

The device will be damaged if immersed in water or subjected to high humidity.

Avoid Sudden Changes in Temperature

Sudden changes in temperature, such as when entering or leaving a heated building on a cold day, can cause condensation to form inside the device. To prevent condensation, place the device in a carrying case or a plastic bag before exposing it to sudden changes in temperature.

Keep away from Strong Magnetic Fields

Do not use or store this device in the vicinity of equipment that generates strong electromagnetic radiation or magnetic fields. Strong static charge or the magnetic fields produced by equipment such as radio transmitters could interfere with the monitor, damage data saved on the memory card, or affect the product's internal circuitry.

Do Not Point the Lens at Strong Light Sources for Extended Periods

Avoid pointing the lens at the sun or other strong light sources for extended periods when using or storing the camera. Intense light may cause deterioration of the image sensor, producing a white blur effect in photographs.

Turn the Product off Before Removing or Disconnecting the Power Source

Do not remove the battery while the product is on, or while images are being saved or deleted. Forcibly cutting power in these circumstances could result in loss of data or in damage to product memory or internal circuitry.

Notes About the Monitor

- The monitor may contain a few pixels that are always lit or that do not light. This is a characteristic common to all TFT LCD displays, and does not indicate a malfunction. Images saved using the product will not be affected.
- White or colored streaks may be visible when bright subjects are framed in the monitor. This phenomenon, known as "smear," occurs when extremely bright light strikes the image sensor; it is characteristic of image sensors and does not indicate a malfunction. Smear may also take the form of partial discoloration in the monitor during shooting. It does not appear in images saved with the camera except in the cases of movies and of images saved with **Multi-shot 16** selected for **Continuous**. When shooting in these modes, we recommend that you avoid bright subjects such as the sun, reflected sunlight, and electric lights.
- Images in the monitor may be difficult to see under bright lighting.
- The monitor is lit by an LED backlight. Should the monitor begin to dim or flicker, contact your Nikon-authorized service representative.

The Battery

- Check the battery level before using the camera and replace or charge the battery if necessary. Do not continue charging once the battery is fully charged as this will result in reduced battery performance. Whenever possible, carry a fully charged spare battery when taking pictures on important occasions.
- Do not use the battery at ambient temperatures below 0 °C (32 °F) or above 40 °C (104 °F).
- Charge the battery indoors with an ambient temperature of 5 °C to 35 °C (41 °F to 95 °F) before use.
- When charging the camera using the Charging AC adapter EH-69P or a computer, the charge capacity may decrease at ambient temperatures 45 °C to 60 °C (113 °F to 140 °F).
- The battery is not charged at ambient temperatures below 0 °C (32 °F) or above 60 °C (140 °F).
- Note that the battery may become hot during use; wait for the battery to cool before charging. Failure to observe these precautions could damage the battery, impair its performance, or prevent it from charging normally.
- On cold days, the capacity of batteries tends to decrease. If an exhausted battery is used at a low temperature, the camera not turn on. Be sure that the battery is fully charged before heading outside to take pictures in cold weather. Keep spare batteries in a warm place and exchange as necessary. Once warmed, a cold battery may recover some of its charge.
- Dirt on the battery terminals can prevent the camera from functioning. Should the battery terminals become dirty, wipe them off with a clean, dry cloth before use.
- If the battery will not be used for some time, insert it in the camera and run it flat before removing it for storage. The battery should be stored in a cool location with an ambient temperature of 15 to 25 °C (59 to 77 °F). Do not store the battery in hot or extremely cold locations.
- Always remove the battery from the camera or optional battery charger when it is not being used. When inserted, minute amounts of current are drawn from the battery even when not in use. This may result in excessive draining of the battery and complete loss of function. Turning the camera on or off while the battery is exhausted can result in reduced battery life.
- Recharge the battery at least once every six months and completely exhaust it before returning it to storage.
- After removing the battery from the camera or optional battery charger, replace the included terminal cover and store it in a cool place.
- A marked drop in the time a fully-charged battery retains its charge, when used at room temperature, indicates that the battery needs to be replaced. Purchase a new EN-EL12 battery.
- Replace the battery when it no longer holds a charge. Used batteries are a valuable resource. Please recycle used batteries in accordance with local regulations.

Charging AC Adapter

- The Charging AC Adapter EH-69P is for use only with compatible devices. Do not use with another make or model of device.
- The EH-69P is compatible with AC 100-240 V, 50/60 Hz electrical outlets. When using in other countries, use a plug adapter (commercially available) as necessary. For more information about plug adapters, consult your travel agency.
- Do not, under any circumstances, use another make or model of AC adapter other than Charging AC Adapter EH-69P or USB-AC adapter. Failure to observe this precaution could result in overheating or in damage to the camera.

Memory Cards

- Use only Secure Digital memory cards. See “Approved Memory Cards” (📖 19) for recommended memory cards.
- Observe the precautions noted in the documentation included with your memory card.
- Do not affix labels or stickers to the memory card.
- Do not format the memory card using a computer.
- Before using a memory card with this camera, we recommend using this camera to format the memory card, especially if the memory card was used previously in another device.
- Note that **formatting a memory card permanently deletes all images and other data on the memory card**. If there is data saved on the memory card that you wish to keep, copy that data to a computer before formatting.
- If the message **Card is not formatted. Format card?** is displayed when the camera is turned on, the memory card must be formatted. If there is data on the memory card that you do not want to delete, select **No** and press the **ⓧ** button. Copy that data to a computer before formatting. To format the memory card, select **Yes**.
- Observe the following precautions while formatting the memory card, saving and deleting images, and copying images to a computer, otherwise data or the memory card itself may be damaged.
 - Do not open the battery-chamber/memory card slot cover or remove the memory card or battery.
 - Do not turn off the camera
 - Do not disconnect the AC adapter

Cleaning and Storage

Cleaning

Lens	Avoid touching glass parts with your fingers. Remove dust or lint with a blower (typically a small device with a rubber bulb attached to one end that is pumped to produce a stream of air out the other end). To remove fingerprints or other stains that cannot be removed with a blower, wipe the lens with a soft cloth, using a spiral motion that starts at the center of them and working toward the edges. If this fails, clean the lens using a cloth lightly dampened with commercial lens cleaner.
Monitor	Remove dust or lint with a blower. To remove fingerprints and other stains, clean the monitor with a soft, dry cloth, being careful not to apply pressure.
Body	Use a blower to remove dust, dirt, or sand, then wipe gently with a soft, dry cloth. After using the camera at the beach or other sandy or dusty environment, wipe off any sand, dust, or salt with a dry cloth lightly dampened with fresh water and dry thoroughly. Note that foreign matter inside the camera could cause damage not covered by the warranty.

Do not use alcohol, thinner, or other volatile chemicals.

Storage

Turn the camera off when not in use. Be sure that the power-on lamp is off before putting the camera away. Remove the battery if the camera will not be used for an extended period. Do not store the camera with naphtha or camphor moth balls, or in any of the following locations:





- Next to equipment that produces strong electromagnetic fields, such as televisions or radios
- Exposed to temperatures below -10°C (14°F) or above 50°C (122°F)
- Places that are poorly ventilated or subject to humidity of over 60%

To prevent mold or mildew, take the camera out of storage at least once a month. Turn the camera on and release the shutter a few times before putting the camera away again.











Troubleshooting

If the camera fails to function as expected, check the list of common problems below before consulting your retailer or Nikon-authorized service representative.

Power, Display, Settings Issues

Problem	Cause/Solution	
Battery inserted in the camera cannot be charged.	<ul style="list-style-type: none"> • Confirm all connections. • Off is selected for Charge by computer in the setup menu. • When charging by connecting the camera to a computer, battery charging stops when the camera is turned off. • When charging by connecting the camera to a computer, battery charging stops when the computer is suspended (sleeping), and the camera may turn off. • Depending upon computer specifications, settings, and status, charging the battery inserted in the camera may not be possible via computer connection. 	16 90,  69 90 90 –
Camera cannot be turned on.	<ul style="list-style-type: none"> • Battery is exhausted. • The camera cannot be turned on while connected to an electrical outlet via the Charging AC Adapter. 	20 16
Camera turns off without warning.	<ul style="list-style-type: none"> • Battery is exhausted. • Camera has turned off automatically to save power. • The camera or battery have become too cold and cannot operate properly. • The camera turns off if the Charging AC Adapter is connected while the camera is on. • The camera turns off if the USB cable connecting it to a computer or printer is disconnected. Reconnect the USB cable. • Inside of the camera has become hot. Leave the camera off until the inside of the camera has cooled, and then try turning it on again. 	20 89  4 16 74, 77,  24 –

Troubleshooting







Problem	Cause/Solution	
Monitor is blank.	<ul style="list-style-type: none"> • Camera is off. • Standby mode for saving power: press the power switch, the shutter-release button,  button,  button, or  movie-record) button. • When flash lamp blinks, wait until flash has charged. • Camera and computer are connected via USB cable. • Camera and TV are connected via audio/video cable or HDMI cable. 	21 2, 21 56 74, 77 74,  21
Monitor is hard to read.	<ul style="list-style-type: none"> • Adjust monitor brightness. • Monitor is dirty. Clean monitor. 	88,  58  6
Date and time of recording are not correct.	<ul style="list-style-type: none"> • If camera clock has not been set, "Date not set" indicator blinks during shooting and movie recording. Images and movies saved before clock is set are dated "01/01/2011 00:00". Set the correct time and date from the Time zone and date option in the setup menu. • Check camera clock regularly against more accurate timepieces and reset as required. 	22, 88,  55
No indicators displayed in monitor.	Hide info is selected for Photo info . Select Show info .	88,  58
Print date not available.	Camera clock has not been set.	22, 88,  55
Date not imprinted on images even when Print date is enabled.	<ul style="list-style-type: none"> • The current shooting mode is one that does not support Print date. • The date cannot be imprinted on movies. 	88,  60
Screen for setting time zone and date is displayed when camera is turned on. Camera settings reset.	Clock battery is exhausted; all settings were restored to their default values.	22, 23
Monitor turns off, and the power-on lamp blinks rapidly.	Battery temperature is high. Turn off camera and allow battery to cool down before resuming use. After the lamp blinks for three minutes, the camera will turn off automatically. Pressing the power switch also turns off the camera.	21

Problem	Cause/Solution	
Camera becomes hot.	The camera may become hot when shooting movies for an extended period of time or when the camera is used in a hot area; this is not a malfunction.	–













Characteristics of Digital Cameras











In extremely rare instances, unusual characters may appear in the monitor and the camera may stop functioning. In most cases, this phenomenon is caused by a strong external static charge. Turn the camera off, remove and replace the battery, then turn the camera on again. In the event of continued malfunction, contact your retailer or Nikon-authorized service representative. Note that disconnecting the power source as described above may result in the loss of any data not saved to internal memory or the memory card at the time the problem occurred. Data already saved will not be affected.

Shooting Issues

Problem	Cause/Solution	
Cannot switch to shooting mode.	Disconnect HDMI cable or USB cable.	74, 77,  21,  24
No image captured when the shutter-release button is pressed.	<ul style="list-style-type: none"> When camera is in playback mode, press the  button, the shutter-release button, or the  ( movie-record) button. When menus are displayed, press the MENU button. Battery is exhausted. When flash lamp blinks, flash is charging. 	8, 30
		10
		20
		56
Camera cannot focus.	<ul style="list-style-type: none"> Subject is too close. Try shooting using macro mode, or the Scene auto selector or Close-up scene modes. The intended subject is one with which autofocus does not perform well. Set AF assist in the setup menu to Auto. Turn camera off and then on again. 	40, 43, 59
		29
		89,  63
		21

Troubleshooting











Problem	Cause/Solution	
Images are blurred.	<ul style="list-style-type: none"> Use flash. Increase the ISO sensitivity value. Enable vibration reduction or motion detection. Use BSS (best shot selector). <ul style="list-style-type: none"> Use tripod and self-timer. 	56 37 88 37, 44,  32 58
Streaks of light or partial discoloration are visible in the monitor.	Smear occurs when extremely bright light strikes the image sensor. When shooting with Continuous set to Multi-shot 16 and when recording movies, avoiding bright objects, such as the sun, reflections of the sun, and electric lights is recommended.	37,  32,  3
Bright specks appear in images captured with flash.	Flash is reflecting off particles in air. Set the flash mode setting to  (off).	57
Flash does not fire.	<ul style="list-style-type: none"> The flash mode is set to  (off). Scene mode with which the flash does not fire is selected. On is selected for Blink proof in smart portrait menu. Another function that restricts flash is enabled. 	56 62 50 65
Digital zoom cannot be used.	<ul style="list-style-type: none"> Digital zoom is set to Off in the setup menu. Digital zoom cannot be used in the following situations. <ul style="list-style-type: none"> When Scene auto selector, Portrait, Night portrait, or Pet portrait is selected in scene mode When smart portrait mode is selected When subject tracking mode is selected When Continuous in the shooting menu is set to Multi-shot 16 When recording movies 	89,  63 40, 41, 46 49 51 37,  32 82
Image mode not available.	Another function that restricts the Image mode option is enabled.	65
No sound when shutter is released.	Off is selected for Sound settings > Shutter sound in setup menu. No sound is heard with some shooting modes and settings, even when On is selected.	89,  64
AF-assist illuminator does not light.	Off is selected for the AF assist option in the setup menu. AF-assist illuminator may not light depending on the position of the focus area or the current scene mode, even when Auto is selected.	89,  63
Images appear smeared.	Lens is dirty. Clean lens.	 6
Colors are unnatural.	White balance or hue is not adjusted properly.	37, 43,  30







Problem	Cause/Solution	
Randomly spaced bright pixels ("noise") appear in image.	The subject is dark, so shutter speed is too slow or ISO sensitivity is too high. Noise can be reduced by: <ul style="list-style-type: none"> Using flash. Specifying a lower ISO sensitivity setting. 	56 37,  33
Images are too dark (underexposed).	<ul style="list-style-type: none"> The flash mode is set to  (off). Flash window is blocked. Subject is beyond flash range. Adjust exposure compensation. Increase ISO sensitivity. Subject is backlit. Select Backlighting scene mode or set the flash mode setting to  (fill flash). 	56 26 56 60 37,  33 44, 56
Images are too bright (overexposed).	Adjust exposure compensation.	60
Unexpected results when flash set to  (auto with red-eye reduction).	When taking pictures with  (auto with red-eye reduction) or fill flash with slow sync and red-eye reduction in Night portrait scene mode, In-Camera Red Eye Fix may be applied to areas not affected by red-eye in rare cases. Use any scene mode other than Night portrait , and change the flash mode to any setting other than  (auto with red-eye reduction) and try taking a picture again.	41, 56
Skin tones are not softened.	<ul style="list-style-type: none"> In some shooting conditions, facial skin tones may not be smoothed. Use Skin softening in the playback menu for images containing four or more faces. 	49 73,  14
Saving images takes time.	It may take more time to save images in the following situations. <ul style="list-style-type: none"> When the noise reduction function is in operation, such as when shooting in a dark environment When the flash mode is set to  (auto with red-eye reduction) When the skin softening function is applied while shooting 	– 57 40, 41, 50

Playback Issues

Problem	Cause/Solution	
File cannot be played back.	<ul style="list-style-type: none"> File or folder was overwritten or renamed by computer or other make of camera. The COOLPIX S6200 is not able to play back movies recorded with another make or model of digital camera. 	– 86

Troubleshooting

Problem	Cause/Solution	
Cannot zoom in on image.	<ul style="list-style-type: none"> Playback zoom cannot be used with movies, small pictures, or images that have been cropped to a size of 320 × 240 or smaller. This camera may not be able to zoom in on images captured with another make or model of digital camera. 	–
Cannot record voice memos.	<ul style="list-style-type: none"> Voice memos cannot be attached to movies. Voice memos cannot be attached to images captured with other cameras. Voice memos attached to images using another camera cannot be played back on this camera. 	– 73,  49
Cannot use quick retouch, D-Lighting, skin softening, filter effects, small picture, or crop.	<ul style="list-style-type: none"> These options cannot be used with movies. Images captured at an Image mode setting of  4608×2592 cannot be edited, and the same editing feature cannot be applied multiple times. Camera is unable to edit images captured with other cameras. 	– 73,  10,  11 73,  10,  11
Cannot rotate image	The camera cannot rotate images captured with another make or model of digital camera.	–
Images are not displayed on TV.	<ul style="list-style-type: none"> Video mode or HDMI is not correctly set in the TV settings setup menu. Cables are connected to the HDMI mini connector (Type C) and to the USB/audio/video output connector simultaneously. Memory card contains no images. Replace the memory card. Remove the memory card to play back images from the internal memory. 	89,  68 74, 77,  21,  24 18
Album icons are reset to their default icons, images added to albums cannot be displayed in favorite pictures mode.	Data saved in the internal memory or on the memory card may not be played back correctly if overwritten by a computer.	–

Problem	Cause/Solution	
The saved images are not displayed in auto sort mode.	<ul style="list-style-type: none"> • The desired image was sorted to a category other than the category currently displayed. • Images saved by a camera other than the COOLPIX S6200 and images copied using the Copy option cannot be displayed in auto sort mode. • Images saved in the internal memory or on the memory card may not be played back correctly if overwritten by a computer. • Up to 999 images and movies in total can be added to each category. If the desired category already contains 999 images or movies in total, new images or movies cannot be added. 	72,  72,  – 72, 
Nikon Transfer 2 does not start when camera is connected.	<ul style="list-style-type: none"> • Camera is off. • Battery is exhausted. • USB cable is not correctly connected. • Camera is not recognized by the computer. • Confirm system requirements. • Computer is not set to start Nikon Transfer 2 automatically. For more information about Nikon Transfer 2, refer to help information contained in ViewNX 2. 	21 20 74, 77 – 75 77
The PictBridge startup screen is not displayed when the camera is connected to a printer.	With some PictBridge-compatible printers, the PictBridge startup screen may not be displayed and it may be impossible to print images when Auto is selected for the Charge by computer option in the setup menu. Set the Charge by computer option to Off and reconnect the camera to the printer.	90,  69
Images to be printed are not displayed.	<ul style="list-style-type: none"> • Memory card contains no images. Replace the memory card. • Remove the memory card to print images from the internal memory. 	18
Cannot select paper size with camera.	Paper size cannot be selected from the camera in the following situations, even when printing from a PictBridge-compatible printer. Use the printer to select paper size. <ul style="list-style-type: none"> • The printer does not support the paper sizes specified by the camera. • The printer automatically selects the paper size. 	74,  26,  27 –

Specifications

Nikon COOLPIX S6200 Digital Camera

Type	Compact digital camera
Effective pixels	16.0 million
Image sensor	¹ /2.3-in. type CCD; approx. 16.44 million total pixels
Lens	10x optical zoom, NIKKOR lens
Focal length	4.5-45.0mm (angle of view equivalent to that of 25-250 mm lens in 35mm [135] format)
f/-number	f/3.2-5.8
Construction	8 elements in 8 groups (1 ED lens element)
Digital zoom	Up to 4x (angle of view equivalent to that of approx. 1000 mm lens in 35mm [135] format)
Vibration reduction	Lens shift
Autofocus (AF)	Contrast-detect AF
Focus range (from the center of the front of the lens)	<ul style="list-style-type: none">• [W]: Approx. 50 cm (1 ft 8 in.) to ∞, [T]: Approx. 1.0 m (3 ft 4 in.) to ∞• Macro mode: Approx. 10 cm (4 in.) to ∞ (wide-angle position)
Focus-area selection	Face priority, auto (9-area automatic selection), manual with 99 focus areas, center, subject tracking
Monitor	6.7 cm (2.7-in.), approx. 230k-dot, TFT LCD with anti-reflection coating and 5-level brightness adjustment
Frame coverage (shooting mode)	Approx. 98% horizontal and 98% vertical
Frame coverage (playback mode)	Approx. 100% horizontal and 100% vertical
Storage	
Media	Internal memory (approx. 74 MB), SD/SDHC/SDXC memory card
File system	DCF, Exif 2.3, and DPOF compliant
File formats	Still pictures: JPEG Sound files (Voice Memo): WAV Movies: MOV (Video: H.264/MPEG-4 AVC, Audio: AAC stereo)

Image size (pixels)	<ul style="list-style-type: none"> • 16M (High) [4608 × 3456★] • 16M [4608 × 3456] • 12M [4000 × 3000] • 8M [3264 × 2448] • 5M [2592 × 1944] • 3M [2048 × 1536] • PC [1024 × 768] • VGA [640 × 480] • 16:9 [4608 × 2592]
ISO sensitivity (Standard output sensitivity)	<ul style="list-style-type: none"> • ISO 80, 100, 200, 400, 800, 1600, 3200 • Auto (auto gain from ISO 80 to 1600) • Fixed range auto (ISO 80 to 400, 80 to 800)
Exposure	
Metering	256-segment matrix, center-weighted (digital zoom less than 2x), spot (digital zoom 2x or more)
Exposure control	Programmed auto exposure with motion detection and exposure compensation (-2.0 to +2.0 EV in steps of 1/3 EV)
Shutter	Mechanical and charge-coupled electronic shutter
Speed	<ul style="list-style-type: none"> • 1/2000 -1 s • 4 s (Fireworks show scene mode)
Aperture	Electronically-controlled ND filter (-3.3 AV) selection
Range	2 steps (f/3.2 and f/10.2 [W])
Self-timer	Can be selected from 10 s and 2 s
Flash	
Range (approx.) (ISO sensitivity: Auto)	[W]: 0.5 to 4.6 m (1 ft 8 in. to 15 ft) [T]: 0.5 to 3.0 m (1 ft 8 in. to 9 ft 10 in.)
Flash control	TTL auto flash with monitor preflashes
Interface	Hi-Speed USB
Data transfer protocol	MTP, PTP
Video output	Can be selected from NTSC and PAL
HDMI output	Can be selected from Auto, 480p, 720p, and 1080i
I/O terminal	Audio/video (A/V) output; digital I/O (USB) HDMI mini connector (Type C) (HDMI output)
Supported languages	Arabic, Chinese (Simplified and Traditional), Czech, Danish, Dutch, English, Finnish, French, German, Greek, Hindi, Hungarian, Indonesian, Italian, Japanese, Korean, Norwegian, Polish, Portuguese (European and Brazilian), Romanian, Russian, Spanish, Swedish, Thai, Turkish, Ukrainian, Vietnamese
Power sources	One Rechargeable Li-ion Battery EN-EL12 (included) AC Adapter EH-62F (available separately)

Specifications

Charging time	Approx. 3 hours and 20 minutes (when using Charging AC Adapter EH-69P and when no charge remains)
Battery life (EN-EL12)	Still pictures*: Approx. 250 shots Movies: Approx. 1 h 40 min (HD 720p) The maximum file size for a single movie is 4 GB and the maximum movie length for a single movie is 29 minutes, even when there is sufficient free space on the memory card for longer recording.
Tripod socket	1/4 (ISO 1222)
Dimensions (W × H × D)	Approx. 93.0 × 56.7 × 25.4 mm (3.7 × 2.3 × 1.0 in.) (excluding projections)
Weight	Approx. 160 g (5.7 oz) (including battery and SD memory card)
Operating environment	
Temperature	0°C to 40°C (32°F to 104°F)
Humidity	Less than 85% (no condensation)

- Unless otherwise stated, all figures are for a camera with a fully-charged Rechargeable Li-ion Battery EN-EL12 operated at an ambient temperature of 25°C (77°F).

* Based on Camera and Imaging Products Association (CIPA) standards for measuring the life of camera batteries. Measured at 23 (±2)°C (73 (±4)°F); zoom adjusted with each shot, flash fired with every other shot, image mode set to  **4608×3456**. Battery life may vary depending on shooting interval and length of time menus and images are displayed.

Rechargeable Li-ion Battery EN-EL12

Type	Rechargeable lithium-ion battery
Rated capacity	DC 3.7 V, 1050 mAh
Operating temperature	0°C to 40°C (32°F to 104°F)
Dimensions (W × H × D)	Approx. 32 × 43.8 × 7.9 mm (1.2 × 1.7 × 0.3 in.)
Weight	Approx. 22.5 g (0.8 oz) (excluding terminal cover)

Charging AC Adapter EH-69P

Rated input	AC 100-240 V, 50/60 Hz, 0.068-0.042 A
Rated capacity	6.8–10.1 VA
Rated output	DC 5.0 V, 550 mA
Operating temperature	0°C to 40°C (32°F to 104°F)
Dimensions (W × H × D)	Approx. 55 × 22 × 54 mm (2.2 × 0.9 × 2.1 in.) (excluding plug adapter) For Argentina: Approx. 55 × 59 × 63 mm (2.2 × 2.4 × 2.5 in.) For Brazil and Korea: Approx. 55 × 59 × 66.5 mm (2.2 × 2.4 × 2.6 in.)
Weight	Approx. 55 g (2.0 oz) (excluding plug adapter) For Argentina, Brazil, and Korea: Approx. 80 g (2.9 oz)

✓ Specifications

- Nikon will not be held liable for any errors this manual may contain.
- The appearance of this product and its specifications are subject to change without notice.

Supported Standards

- **DCF:** Design Rule for Camera File System is a standard widely used in the digital camera industry to ensure compatibility among different makes of camera.
- **DPOF:** Digital Print Order Format is an industry-wide standard that allows images to be printed from print orders saved on memory cards.
- **Exif version 2.3:** Exchangeable image file format (Exif) version 2.3 for digital still cameras is a standard that allows information saved with photographs to be used for optimal color reproduction when images are output from Exif-compliant printers.
- **PictBridge:** A standard developed cooperatively by the digital camera and printer industries, allowing photographs to be output directly to a printer without connecting the camera to a computer.

Index

Symbols

AE/AF-L 



 (movie-record) button 4, 5

T (Tele) 27

W (Wide) 27

 Apply selection button 5, 9



 Auto mode 20, 24, 36

 Auto sort mode 72, 

MENU button 4, 5, 10, 37, 73, 85, 88

 Delete button 4, 5, 32, 

 Exposure compensation 60

 Favorite pictures mode 72, 

 Flash mode 56

 Help 39

 Image thumbnail display 31

 List by date mode 72, 

 Macro mode 59

 Playback button 4, 5, 8, 30

 Playback mode 30, 72

 Playback zoom 31

 Scene mode 39

 Self-timer 58

 Setup menu 88

 Shooting mode button 4, 5, 8

 Smart portrait mode 49

SO Special effects mode 47

 Subject tracking mode 51

A

AC adapter 17, 

AF area mode 37, 

AF assist 89, 

Album 

Aperture value 28

Audio/video cable 74,  

Audio/video-in jack 74, 



Auto flash 57



Auto mode 24, 36

Auto off 21, 89, 

Auto sort menu 73, 

Auto sort mode 72, 

Autofocus 38, 53, 59, 85,  

Autofocus mode 38, 53, 85,   

B

Backlighting  44

Battery 14, 16, 23

Battery chamber 3

Battery charger 17, 

Battery latch 14

Battery level 20

Battery-chamber/memory card slot cover 3, 14, 18

Beach  42

Best shot selector 44, 

Black and white copy  44

Black-and-white 37, 

Blink proof 50, 

Blink warning 90, 

Brightness 88, 

BSS 44, 

Button sound 

C

Calendar display 31

Charge by computer 90, 

Charge lamp 3, 17

Charger 16, 

Charging AC Adapter 16, 

Close-up  43

Color options 37, 

Compression ratio 63

Computer 74, 77

Connector cover 3

Continuous 37, 

Copying images 73, 

Crop 31, 

Cyanotype 37, 

D

Date 22, 88, 

Index

Date and time 22, 88, 55
Date format 22, 55
Daylight 30
Daylight saving time 23, 88, 56
Delete 32, 50
Digital zoom 27, 89, 63
Direct print 74, 23
D-Lighting 73, 13
DPOF 18
DPOF print 29
DSCN 77
Dusk/dawn 42

E

EH-69P 16, 78
EN-EL12 14, 16, 78
Exposure compensation 60
Extension 77
Eyelet for camera strap 2

E

Face detection 67
Face priority 37, 35
Face priority tracking 53, 40
Favorite pictures menu 73, 5
Favorite pictures mode 72, 4
File name 77
Fill flash 57
Filmstrip 90, 73
Filter effects 73, 16
Fireworks show 44
Firmware version 90, 76
Fixed range auto 33
Flash 56
Flash lamp 56
Flash mode 56, 57
Flash off 57
Focus 28, 37, 35
Focus indicator 6
Focus lock 70
Folder name 77
Food 43
Format internal memory 89, 66

Format memory cards 18, 89, 66
Formatting 18, 89, 66
FSCN 77
Full-frame playback 30
Full-time AF 38, 85, 37, 53

H

HDMI 68
HDMI cable 21
HDMI device control 68
HDMI mini connector 2
Help 39
High key 47
High-contrast monochrome 47

I

Identifier 77
Image copy 51
Image mode 63
Image review 88, 58
Imprinting date and time 60
Internal memory 19
ISO sensitivity 37, 33

J

JPG 77

L

Landscape 40
Language 89, 67
Lens 2, 14
Lens cover 2
List by date menu 73, 9
List by date mode 72, 9
Low key 47

M

Macro mode 59
Memory capacity 20
Memory card 18
Memory card slot 18
Microphone 2
Monitor 6, 6
Monitor settings 88, 58
Motion detection 89, 62

MOV 77
 Movie length 84
 Movie menu 85
 Movie options 85, 52
 Movie playback 86
 Movie recording 82, 52
 Multi selector 4, 5, 9
 Multi-shot 16 32
 Museum 44

N
 Night landscape 42
 Night portrait 41
 Nikon Transfer 2 76, 78
 Nostalgic sepia **SE** 47
 Number of exposures remaining 20, 64

O
 Optical zoom 27
 Optional accessories 78

P
 Panorama assist 45, 2
 Panorama Maker 5 45, 76, 3
 Paper size 26, 27
 Party/indoor 41
 Pet portrait auto release 46
 Pet portrait 46
 Photo info 88, 58
 PictBridge 74, 23, 18
 Playback 30, 86, 49
 Playback menu 73, 41
 Playback mode 8, 30, 72
 Playback zoom 31
 Portrait 40
 Power 20, 21
 Power switch 20, 21
 Power-on lamp 20, 21
 Preset manual 31
 Pressing halfway 4
 Print 73, 26, 27, 41
 Print date 23, 88, 60
 Print order 73, 41
 Print order date option 23, 42, 44

Printer 74, 23
 Protect 73, 46

Q
 Quick retouch 73, 12

R
 Rechargeable battery 78
 Rechargeable Li-ion battery 14, 16, 78
 Recording movies 82, 52
 Red-eye reduction 57
 Remove from favorites 5
 Reset all 90, 74
 Rotary multi selector 4, 5, 9
 Rotate image 73, 48
 RSCN 77

S
 Scene auto selector 40
 Scene mode 39, 40
 Selective color 47
 Self-timer 58
 Self-timer lamp 2, 58
 Sepia 37, 34
 Setup menu 88
 Shooting 24, 26, 28
 Shooting menu 37, 30
 Shooting mode 8, 24
 Shutter sound 64
 Shutter speed 28
 Shutter-release button 4, 5, 28
 Single 37, 32
 Single AF 38, 85, 37, 53
 Skin softening 50, 73, 14, 38
 Slide show 73, 45
 Slow sync 57
 Small picture 73, 18
 Smart portrait menu 50, 38
 Smart portrait mode 49
 Smile timer 50, 38
 Snow 42
 Soft **SO** 47
 Sound settings 89, 64
 Speaker 3

Index

Special effects mode 47

Sports  41

SSCN  77

Standard color 37,  34

Strap 12

Subject tracking menu 53,  40



Subject tracking mode 51

Sunset  42

I

Thumbnail display 31

Time difference 88,  57

Time zone 88,  55,  57

Tripod socket 3,  16

TV 74,  21

TV settings 89,  68

U

USB cable 74, 77,  24,  78

USB/audio/video output connector 74,
77,  21,  23

V

Vibration reduction 88,  61

Video mode  68

ViewNX 2 75

Vivid color 37,  34

Voice memo 73,  49

Volume 86,  49

W

WAV  77

Welcome screen 88,  54

White balance 37,  30

Wind noise reduction 85,  53

Z

Zoom control 4, 5, 27

Zoom in 27

Zoom out 27

Nikon

No reproduction in any form of this manual, in whole or in part (except for brief quotation in critical articles or reviews), may be made without written authorization from NIKON CORPORATION.



NIKON CORPORATION

© 2011 Nikon Corporation

CT1G01(11)
6MM12011-01