

Nikon

DIGITAL CAMERA

COOLPIX S8200

Reference Manual

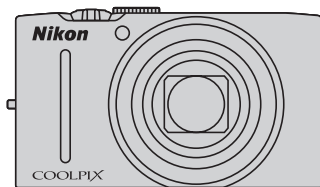

En

Trademark Information

- Microsoft, Windows and Windows Vista are either registered trademarks or trademarks of Microsoft Corporation in the United States and/or other countries.
- Macintosh, Mac OS, and QuickTime are trademarks of Apple Inc., registered in the U.S. and other countries. The iFrame logo and the iFrame symbol are trademarks of Apple Inc.
- Adobe and Acrobat are registered trademarks of Adobe Systems Inc.
- SDXC, SDHC and SD Logos are trademarks of SD-3C, LLC.
- PictBridge is a trademark.
- HDMI, **HDMI** logo and High-Definition Multimedia Interface are trademarks or registered trademarks of HDMI Licensing LLC.
- All other trade names mentioned in this manual or the other documentation provided with your Nikon product are trademarks or registered trademarks of their respective holders.

AVC Patent Portfolio License

This product is licensed under the AVC Patent Portfolio License for the personal and non-commercial use of a consumer to (i) encode video in compliance with the AVC standard ("AVC video") and/or (ii) decode AVC video that was encoded by a consumer engaged in a personal and non-commercial activity and/or was obtained from a video provider licensed to provide AVC video. No license is granted or shall be implied for any other use. Additional information may be obtained from MPEG LA, L.L.C.

See <http://www.mpegla.com>.

Introduction

Parts of the Camera and Basic Operations

The Basics of Shooting and Playback

Shooting Features

Playback Features

Recording and Playing Back Movies

General Camera Setup

Reference Section

Technical Notes and Index

Read This First

Thank you for purchasing the Nikon COOLPIX S8200 digital camera. Before using the camera, please read the information in "For Your Safety" (vi) and familiarize yourself with the information provided in this manual. After reading, please keep this manual handy and refer to it to enhance your enjoyment of your new camera.

Confirming the Package Contents

In the event that any items are missing, please contact the store where you purchased the camera.

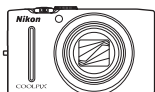

COOLPIX S8200
Digital Camera



Camera Strap



Rechargeable Li-ion Battery
EN-EL12 (with terminal
cover)

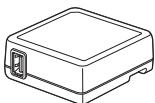

Charging AC Adapter
EH-69P*

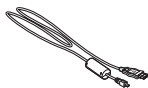

USB Cable UC-E6

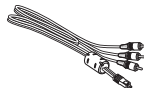

Audio Video Cable EG-CP16



ViewNX 2 Installer CD



Reference Manual CD

- Warranty

* A plug adapter is included if the camera was purchased in a country or region that requires a plug adapter. The shape of the plug adapter varies with the country or region of purchase.

NOTE: A memory card is not included with the camera.

About This Manual







If you want to start using the camera right away, see “The Basics of Shooting and Playback” (📖 13).

To learn about the parts of the camera and basic operations, see “Parts of the Camera and Basic Operations” (📖 1).

Other Information

- Symbols and Conventions

To make it easier to find the information you need, the following symbols and conventions are used in this manual:

Icon	Description
	This icon indicates cautions and information that should be read before using the camera.
	This icon marks notes, information that should be read before using the camera.
  	These icons indicate other pages containing relevant information;  : “Reference Section,”  : “Technical Notes and Index.”

- SD, SDHC, and SDXC memory cards are referred to as “memory cards” in this manual.
- The setting at the time of purchase is referred to as the “default setting.”
- The names of menu items displayed in the camera monitor, and the names of buttons or messages displayed on a computer monitor appear in bold.
- In this manual, images are sometimes omitted from monitor display samples so that monitor indicators can be more clearly shown.
- Illustrations and monitor content shown in this manual may differ from the actual product.

Information and Precautions

Life-Long Learning

As part of Nikon's "Life-Long Learning" commitment to ongoing product support and education, continually updated information is available online at the following sites:

- For users in the U.S.A.: <http://www.nikonusa.com/>
- For users in Europe and Africa: <http://www.europe-nikon.com/support/>
- For users in Asia, Oceania, and the Middle East: <http://www.nikon-asia.com/>

Visit these sites to keep up-to-date with the latest product information, tips, answers to frequently asked questions (FAQs), and general advice on digital imaging and photography. Additional information may be available from the Nikon representative in your area. Visit the site below for contact information:

<http://imaging.nikon.com/>

Use Only Nikon Brand Electronic Accessories

Nikon COOLPIX cameras are designed to the highest standards and include complex electronic circuitry. Only Nikon brand electronic accessories (including battery chargers, batteries, Charging AC adapters, and AC adapters) certified by Nikon specifically for use with this Nikon digital camera are engineered and proven to operate within the operational and safety requirements of this electronic circuitry.

THE USE OF NON-NIKON ELECTRONIC ACCESSORIES COULD DAMAGE THE CAMERA AND MAY VOID YOUR NIKON WARRANTY.

The use of third-party rechargeable Li-ion batteries not bearing the Nikon holographic seal could interfere with normal operation of the camera or result in the batteries overheating, igniting, rupturing, or leaking.

For more information about Nikon brand accessories, contact a local authorized Nikon dealer.

Holographic seal: Identifies this device as an authentic Nikon product.



Before Taking Important Pictures

Before taking pictures on important occasions (such as at weddings or before taking the camera on a trip), take a test shot to ensure that the camera is functioning normally. Nikon will not be held liable for damages or lost profits that may result from product malfunction.

About the Manuals

- No part of the manuals included with this product may be reproduced, transmitted, transcribed, stored in a retrieval system, or translated into any language in any form, by any means, without Nikon's prior written permission.
- Nikon reserves the right to change the specifications of the hardware and software described in these manuals at any time and without prior notice.
- Nikon will not be held liable for any damages resulting from the use of this product.
- While every effort was made to ensure that the information in these manuals is accurate and complete, we would appreciate it were you to bring any errors or omissions to the attention of the Nikon representative in your area (address provided separately).

Notice Concerning Prohibition of Copying or Reproduction

Note that simply being in possession of material that was digitally copied or reproduced by means of a scanner, digital camera or other device may be punishable by law.

• Items prohibited by law from being copied or reproduced

Do not copy or reproduce paper money, coins, securities, government bonds or local government bonds, even if such copies or reproductions are stamped "Sample." The copying or reproduction of paper money, coins, or securities which are circulated in a foreign country is prohibited. Unless the prior permission of the government was obtained, the copying or reproduction of unused postage stamps or post cards issued by the government is prohibited.

The copying or reproduction of stamps issued by the government and of certified documents stipulated by law is prohibited.

• Cautions on certain copies and reproductions

The government has issued cautions on copies or reproductions of securities issued by private companies (shares, bills, checks, gift certificates, etc.), commuter passes, or coupon tickets, except when a minimum of necessary copies are to be provided for business use by a company. Also, do not copy or reproduce passports issued by the government, licenses issued by public agencies and private groups, ID cards and tickets, such as passes and meal coupons.

• Comply with copyright notices

The copying or reproduction of copyrighted creative works such as books, music, paintings, woodcut prints, maps, drawings, movies, and photographs is governed by national and international copyright laws. Do not use this product for the purpose of making illegal copies or to infringe copyright laws.

Disposing of Data Storage Devices

Please note that deleting images or formatting data storage devices such as memory cards or built-in camera memory does not completely erase the original image data. Deleted files can sometimes be recovered from discarded storage devices using commercially available software, potentially resulting in the malicious use of personal image data. Ensuring the privacy of such data is the user's responsibility.

Before discarding a data storage device or transferring ownership to another person, erase all data using commercial deletion software, or format the device and then completely refill it with images containing no private information (for example, pictures of empty sky). Be sure to also replace any pictures selected for the **Select an image** option in the **Welcome screen** setting (📖 94). Care should be taken to avoid injury or damage to property when physically destroying data storage devices.

For Your Safety

To prevent damage to your Nikon product or injury to yourself or to others, read the following safety precautions in their entirety before using this equipment. Keep these safety instructions where all those who use the product will read them.



This icon marks warnings, information that should be read before using this Nikon product, to prevent possible injury.

WARNINGS

Turn off in the event of malfunction

Should you notice smoke or an unusual smell coming from the camera or Charging AC Adapter, unplug the Charging AC Adapter and remove the battery immediately, taking care to avoid burns. Continued operation could result in injury. After removing or disconnecting the power source, take the equipment to a Nikon-authorized service representative for inspection.

Do not disassemble

Touching the internal parts of the camera or Charging AC Adapter could result in injury. Repairs should be performed only by qualified technicians. Should the camera or Charging AC Adapter break open as the result of a fall or other accident, take the product to a Nikon-authorized service representative for inspection, after unplugging the product and/or removing the battery.

Do not use the camera or Charging AC Adapter in the presence of flammable gas

Do not use electronic equipment in the presence of flammable gas, as this could result in explosion or fire.

Handle the camera strap with care

Never place the strap around the neck of an infant or child.

Keep out of reach of children

Particular care should be taken to prevent infants from putting the battery or other small parts into their mouths.

Do not remain in contact with the camera, battery charger, or AC adapter for extended periods while the devices are on or in use

Parts of the devices become hot. Leaving the devices in direct contact with the skin for extended periods may result in low-temperature burns.

Observe caution when handling the battery

The battery may leak, overheat, or explode if improperly handled. Observe the following precautions when handling the battery for use in this product:

- Before replacing the battery, turn the product off. If you are using the Charging AC Adapter/AC adapter, be sure it is unplugged.
- Use only a Rechargeable Li-ion Battery EN-EL12 (included). Charge the battery by using a camera that supports battery charging or by using a Battery Charger MH-65 (available separately). To charge the battery with the camera, use either Charging AC Adapter EH-69P (included) or the **Charge by computer** function.
- When inserting the battery, do not attempt to insert it upside down or backwards.
- Do not short or disassemble the battery or attempt to remove or break the battery insulation or casing.
- Do not expose the battery to flame or to excessive heat.
- Do not immerse in or expose to water.
- Replace the terminal cover when transporting the battery. Do not transport or store with metal objects such as necklaces or hairpins.
- The battery is prone to leakage when fully discharged. To avoid damage to the product, be sure to remove the battery when no charge remains.
- Discontinue use immediately should you notice any change in the battery, such as discoloration or deformation.

Observe the following precautions when handling the Charging AC Adapter

- If liquid from the damaged battery comes in contact with clothing or skin, rinse immediately with plenty of water.
- Keep dry. Failure to observe this precaution could result in fire or electric shock.
- Dust on or near the metal parts of the plug should be removed with a dry cloth. Continued use could result in fire.
- Do not handle the plug or go near the Charging AC Adapter during lightning storms. Failure to observe this precaution could result in electric shock.
- Do not damage, modify, forcibly tug or bend the USB cable, place it under heavy objects, or expose it to heat or flames. Should the insulation be damaged and the wires become exposed, take it to a Nikon-authorized service representative for inspection. Failure to observe these precautions could result in fire or electric shock.
- Do not handle the plug or Charging AC Adapter with wet hands. Failure to observe this precaution could result in electric shock.
- Do not use with travel converters or adapters designed to convert from one voltage to another or with DC-to-AC inverters. Failure to observe this precaution could damage the product or cause overheating or fire.

 **Use appropriate cables**

When connecting cables to the input and output jacks, use only the cables provided or sold by Nikon for the purpose, to maintain compliance with product regulations.

 **Handle moving parts with care**

Be careful that your fingers or other objects are not pinched by the lens cover or other moving parts.

 **CD-ROMs**

The CD-ROMs included with this device should not be played back on audio CD equipment. Playing CD-ROMs on an audio CD player could cause hearing loss or damage the equipment.

 **Observe caution when using the flash**

Using the flash close to your subject's eyes could cause temporary visual impairment. Particular care should be observed if photographing infants, when the flash should be no less than 1 m (3 ft 4 in.) from the subject.

 **Do not operate the flash with the flash window touching a person or object**

Failure to observe this precaution could result in burns or fire.

 **Avoid contact with liquid crystal**

Should the monitor break, care should be taken to avoid injury caused by broken glass and to prevent liquid crystal from the monitor touching the skin or entering the eyes or mouth.

 **Turn the power off when using inside an airplane or the hospital**

Turn the power off while inside the airplane during take off or landing. Follow the instructions of the hospital when using while in a hospital. The electromagnetic waves given out by this camera may disrupt the electronic systems of the airplane or the instruments of the hospital.

Notices

Notices for Customers in the U.S.A.

IMPORTANT SAFETY INSTRUCTIONS - SAVE THESE INSTRUCTIONS.

DANGER - TO REDUCE THE RISK OF FIRE OR ELECTRIC SHOCK, CAREFULLY FOLLOW THESE INSTRUCTIONS

For connection to a supply not in the U.S.A., use an attachment plug adapter of the proper configuration for the power outlet if needed.

The power supply unit is intended to be correctly orientated in a vertical or floor mount position.

Federal Communications Commission (FCC) Radio Frequency Interference Statement

This equipment has been tested and found to comply with the limits for a Class B digital device, pursuant to Part 15 of the FCC rules. These limits are designed to provide reasonable protection against harmful interference in a residential installation. This equipment generates, uses, and can radiate radio frequency energy and, if not installed and used in accordance with the instructions, may cause harmful interference to radio communications. However, there is no guarantee that interference will not occur in a particular installation. If this

equipment does cause harmful interference to radio or television reception, which can be determined by turning the equipment off and on, the user is encouraged to try to correct the interference by one or more of the following measures:

- Reorient or relocate the receiving antenna.
- Increase the separation between the equipment and receiver.
- Connect the equipment into an outlet on a circuit different from that to which the receiver is connected.
- Consult the dealer or an experienced radio/television technician for help.



Nikon

COOLPIX S8200

CAUTIONS

Modifications

The FCC requires the user to be notified that any changes or modifications made to this device that are not expressly approved by Nikon Corporation may void the user's authority to operate the equipment.

Interface Cables

Use the interface cables sold or provided by Nikon for your equipment. Using other interface cables may exceed the limits of Class B Part 15 of the FCC rules.

Notice for customers in the State of California

WARNING

Handling the cord on this product will expose you to lead, a chemical known to the State of California to cause birth defects or other reproductive harm.

Wash hands after handling.

Nikon Inc.,

1300 Walt Whitman Road
Melville, New York 11747-3064
USA

Tel: 631-547-4200

Notice for customers in Canada

CAUTION

This Class B digital apparatus complies with Canadian ICES-003.

ATTENTION

Cet appareil numérique de la classe B est conforme à la norme NMB-003 du Canada.

Notices for customers in Europe

CAUTIONS

RISK OF EXPLOSION IF BATTERY IS REPLACED BY AN INCORRECT TYPE.

DISPOSE OF USED BATTERIES ACCORDING TO THE INSTRUCTIONS.

This symbol indicates that this product is to be collected separately.

The following apply only to users in European countries:

- This product is designated for separate collection at an appropriate collection point. Do not dispose of as household waste.
- For more information, contact the retailer or the local authorities in charge of waste management.



This symbol on the battery indicates that the battery is to be collected separately.

The following apply only to users in European countries:





















































- All batteries, whether marked with this symbol or not, are designated for separate collection at an appropriate collection point. Do not dispose of as household waste.
- For more information, contact the retailer or the local authorities in charge of waste management.









































Table of Contents

Introduction	ii
Read This First	ii
Confirming the Package Contents	ii
About This Manual	iii
Information and Precautions	iv
For Your Safety	vi
WARNINGS	vi
Notices	ix
<hr/>	
Parts of the Camera and Basic Operations	1
Parts of the Camera	2
The Camera Body	2
Controls Used in Shooting Mode	4
Controls Used in Playback Mode	5
The Monitor	6
Basic Operations	9
Switching Between Shooting Mode and Playback Mode	9
Using the Rotary Multi Selector	10
Using Menus (the MENU Button)	11
Attaching the Camera Strap	12
<hr/>	
The Basics of Shooting and Playback	13
Preparation 1 Insert the Battery	14
Preparation 2 Charge the Battery	16
Preparation 3 Insert a Memory Card	18
Internal Memory and Memory Cards	19
Approved Memory Cards	19
Step 1 Turn the Camera On	20
Turning the Camera On and Off	21
Setting the Display Language, Date, and Time	22
Step 2 Select a Shooting Mode	24
Available Shooting Modes	25
Step 3 Frame a Picture	26
Using the Zoom	27
Step 4 Focus and Shoot	28
Step 5 Play Back Images	30
Changing How Images Are Displayed	31
Step 6 Delete Unwanted Images	32

Shooting Features	35
📷 (Auto) Mode	36
Changing 📷 (Auto) Mode Settings	36
Options Available in the Auto Shooting Menu.....	37
Scene Mode (Shooting Suited to Scenes)	39
Changing Scene Mode Settings.....	40
Characteristics of Each Scene.....	40
Continuous Shooting Mode (Burst Shooting)	50
Changing Continuous Shooting Mode Settings	51
Options Available in the Continuous Shooting Menu.....	52
Special Effects Mode (Applying Effects When Shooting)	53
Changing Special Effects Mode Settings.....	54
Features That Can Be Set Using the Multi Selector	55
Available Features	55
Using the Flash (Flash Mode)	56
Using the Self-timer	59
Using the Smile Timer, Smile Timer Continuous	61
Using Macro Mode	64
Adjusting Brightness (Exposure Compensation), Vividness, and Hue (Creative Slider)	65
Adjusting Brightness (Exposure Compensation).....	68
Default Settings	69
Changing the Image Size (Image Mode)	71
Image Mode Settings (Image Size and Quality)	71
Features That Cannot Be Used Simultaneously	73
Using Face Detection.....	76
Using Skin Softening.....	77
Focus Lock	78
Playback Features.....	79
Features Available in Playback Mode (Playback Menu).....	80
Connecting the Camera to a TV, Computer, or Printer	81
Using ViewNX 2	82
Installing ViewNX 2.....	82
Transferring Images to the Computer	84
Viewing Images.....	85
Retouching Photographs	86
Editing Movies.....	86
Printing Images.....	86
Recording and Playing Back Movies.....	87
Recording Movies	88
Changing Movie Recording Settings (the Movie Menu)	91
Playing Back Movies.....	92

General Camera Setup.....	93
The Setup Menu	94
Reference Section	 1
Using Easy Panorama (Shooting and Playback)	 2
Shooting With Easy Panorama	 2
Playing Back Images With Easy Panorama (Scroll Playback).....	 4
Using Panorama Assist.....	 5
Playing Back and Deleting Images Captured Continuously (Sequence)	 7
Playing Back Sequences.....	 7
Deleting Images in a Sequence.....	 9
Editing Still Images.....	 10
Editing Features.....	 10
 Quick Retouch: Enhancing Contrast and Saturation	 12
 D-Lighting: Enhancing Brightness and Contrast.....	 13
 Skin Softening: Softening Skin Tones.....	 14
 Filter Effects: Applying Digital Filter Effects.....	 16
 Small Picture: Reducing the Size of an Image.....	 18
 Crop: Creating a Cropped Copy	 19
Connecting the Camera to a TV (Viewing Images on a TV)	 21
Connecting the Camera to a Printer (Direct Print).....	 23
Connecting the Camera to a Printer.....	 24
Printing Individual Images.....	 26
Printing Multiple Images.....	 27
The Shooting Menu (for  (Auto) Mode, Continuous Shooting Mode).....	 30
White Balance (Adjusting Hue).....	 30
Metering.....	 33
ISO Sensitivity.....	 34
Continuous Shooting.....	 35
AF Area Mode	 37
Autofocus Mode.....	 42
The Playback Menu	 43
 Print Order (Creating a DPOF Print Order).....	 43
 Slide Show.....	 46
 Protect.....	 47
 Rotate Image.....	 49
 Voice Memo	 50
 Copy (Copy Between Internal Memory and Memory Card)	 52
 Sequence Display Options.....	 54
 Choose Key Picture	 54

The Movie Menu	 55
Movie Options	 55
Autofocus Mode.....	 59
The Setup Menu	 60
Welcome Screen	 60
Time Zone and Date	 61
Monitor Settings.....	 64
Print Date (Imprinting Date and Time).....	 66
Vibration Reduction	 67
Motion Detection	 68
AF Assist.....	 69
Digital Zoom.....	 70
Sound Settings.....	 71
Auto Off	 72
Format Memory/Format Card	 73
Language.....	 74
TV Settings	 74
Charge by Computer.....	 75
Blink Warning	 77
Filmstrip	 79
Reset All	 80
Firmware Version	 83
File and Folder Names	 84
Optional Accessories	 85
Error Messages	 86

Technical Notes and Index	 1
Caring for the Product	 2
The Camera	 2
The Battery	 4
Charging AC Adapter	 5
Memory Cards	 5
Cleaning and Storage	 6
Cleaning	 6
Storage	 6
Troubleshooting	 7
Specifications	 15
Supported Standards	 19
Index	 20



Parts of the Camera and Basic Operations

This chapter describes the parts of the camera and also explains how to use basic camera features.

Parts of the Camera	2
The Camera Body	2
Controls Used in Shooting Mode	4
Controls Used in Playback Mode	5
The Monitor	6
Basic Operations	9
Switching Between Shooting Mode and Playback Mode	9
Using the Rotary Multi Selector.....	10
Using Menus (the MENU Button)	11
Attaching the Camera Strap.....	12

➔ If you want to start using the camera right away, see “The Basics of Shooting and Playback” (📖 13).

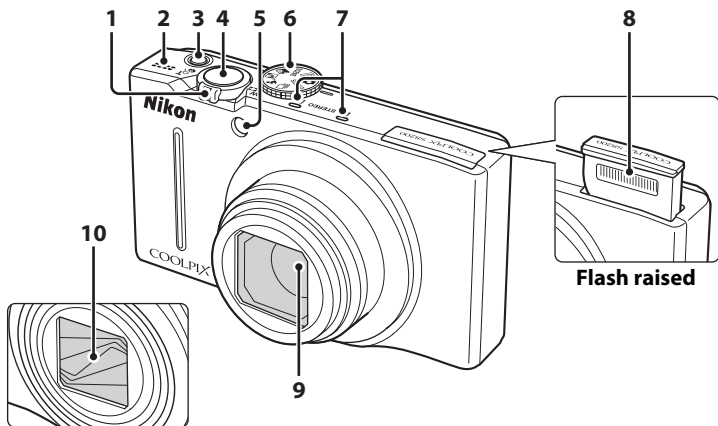

Parts of the Camera

The Camera Body



Lens cover closed





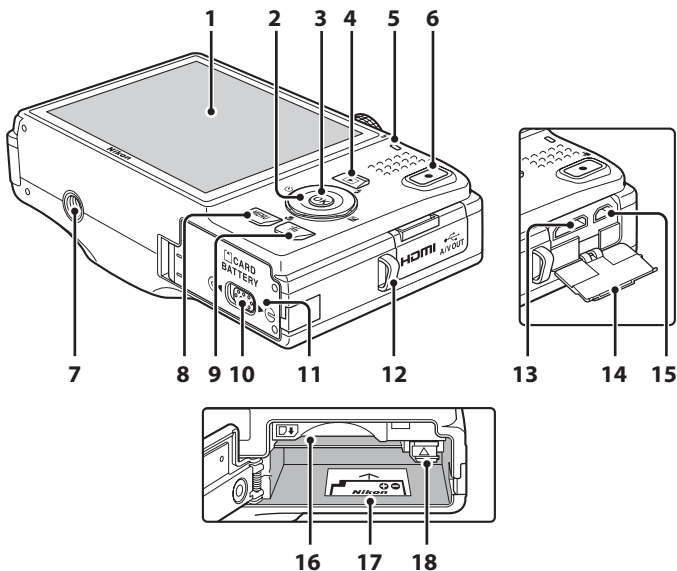



Flash raised

1	Zoom control.....4, 5, 27	5	Self-timer lamp.....59	
	W : wide.....4, 27		AF-assist illuminator95	
	T : tele.....4, 27		6	7
	 : thumbnail playback.....5, 31			
	 : playback zoom.....5, 31			
 : help.....39	8	9	10	
2 Speaker.....80, 92				
3	Power switch/power-on lamp			
20			
4	Shutter-release button.....4, 5, 28			



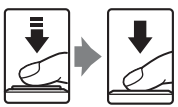









1	Monitor	6, 24	11	Battery-chamber/ memory card slot cover.....	14, 15
2	Rotary multi selector (multi selector)...	10	12	Eyelet for camera strap.....	12
3	OK (apply selection) button.....	5, 10	13	HDMI mini connector (Type C).....	81
4	▶ (playback) button.....	4, 5, 9, 30, 80	14	Connector cover.....	16, 81
5	Charge lamp	17, 76	15	USB/audio/video output connector	16, 81
6	● (movie-record) button	4, 5, 88	16	Memory card slot.....	18
7	Tripod socket	17	17	Battery chamber.....	14
8	MENU button.....	4, 5, 11, 37, 80, 91, 94	18	Battery latch	14
9	🗑 (delete) button.....	4, 5, 32, 80			
10	Cover latch.....	14, 18			

Controls Used in Shooting Mode

Control	Name	Main Function	
	Mode dial	Switches to another shooting mode.	24
	Zoom control	Zooms in and out; rotate to T (Q) to zoom in and make the subject larger, and rotate to W (R) to zoom out and view a wider area.	27
	Rotary multi selector	See "Using the Rotary Multi Selector."	10, 11
	MENU button	Displays and hides the menu.	11, 37, 91, 94
	Shutter-release button	When pressed halfway (i.e., if you stop pressing when you feel resistance): Sets focus and exposure. When pressed all the way: Releases the shutter.	28
	Movie-record button	Starts and stops movie recording.	88
	Playback button	Plays back images.	9, 30, 92
	Delete button	Deletes the last image that was saved.	32

Controls Used in Playback Mode

Control	Name	Main Function	
	Playback button	<ul style="list-style-type: none"> When the camera is off, press and hold this button to turn the camera on and to change to playback mode. Returns to shooting. 	21, 30 9
	Zoom control	<ul style="list-style-type: none"> When rotated to T (Q): Magnifies the image. When rotated to W (R): Displays thumbnails or the calendar. Adjusts the volume when playing back voice memos and movies 	31 31 80, 92,  50
	Rotary multi selector	See “Using the Rotary Multi Selector.”	10, 11
	Apply selection button	<ul style="list-style-type: none"> Displays the histogram and shooting information. Switches from image thumbnail or zoomed image display to full-frame display. Plays back movies. 	30 31 92
	MENU button	Displays and hides the menu.	11, 80, 94
	Delete button	Deletes images.	32
	Mode dial		–
	Shutter-release button	Returns to shooting.	–
	Movie-record button		–



The Monitor

- The information that is displayed in the monitor during shooting and playback changes depending on the camera's settings and state of use. By default, information is displayed when the camera is turned on and when you operate the camera, and turns off after a few seconds (when **Monitor settings** (📖 94) → **Photo info** is set to **Auto info**).

Shooting Mode

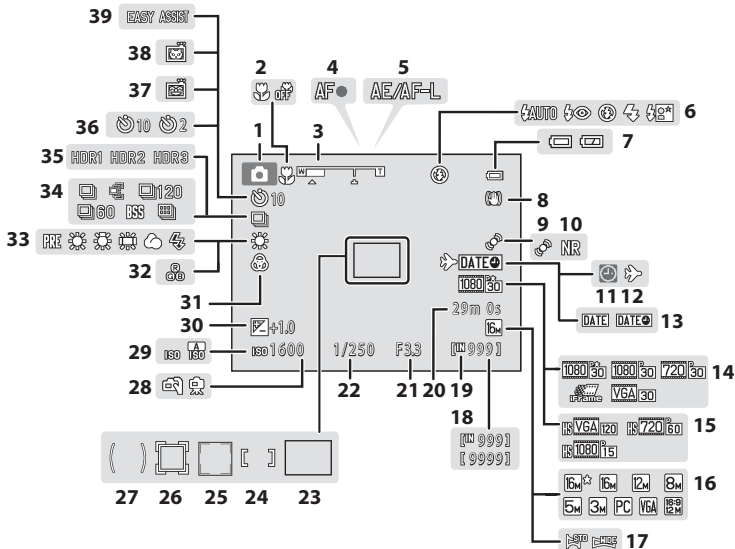
Parts of the Camera and Basic Operations



1	Shooting mode.....	24, 25	21	Aperture value.....	28
2	Macro mode.....	64	22	Shutter speed.....	28
3	Zoom indicator.....	27, 64	23	Focus area (auto, target finding AF)	28, 37
4	Focus indicator.....	28	24	Focus area (manual or center).....	37
5	AE/AF-L indicator.....	 5	25	Focus area (face detection, pet detection).....	37, 43, 61
6	Flash mode.....	56	26	Focus area (subject tracking).....	37
7	Battery level indicator.....	20	27	Center-weighted metering area.....	37
8	Vibration reduction icon.....	94	28	Hand-held/tripod.....	41, 45
9	Motion detection icon.....	95	29	ISO sensitivity.....	37
10	Noise reduction burst.....	44	30	Exposure compensation value.....	67, 68
11	"Date not set" indicator....	23, 94,  86	31	Vividness.....	67
12	Travel destination icon.....	94	32	Hue.....	67
13	Print date.....	94	33	White balance.....	37
14	Movie options (normal speed movies)	91	34	Continuous shooting mode.....	43, 50
15	Movie options (HS movies).....	91	35	Backlighting (HDR).....	42
16	Image mode.....	71	36	Self-timer.....	59
17	Easy panorama.....	49	37	Smile timer, smile timer continuous.....	61
18	Number of exposures remaining (still images).....	20	38	Pet portrait auto release.....	43
19	Internal memory indicator.....	20	39	Panorama.....	49
20	Movie length.....	88			

Playback Mode

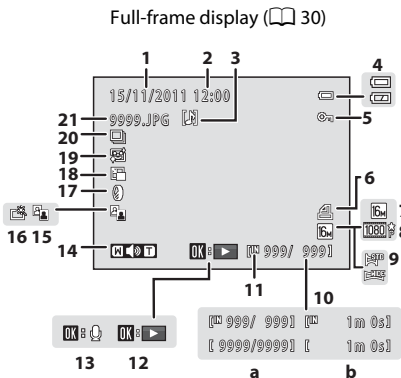

Shooting information (book 30)

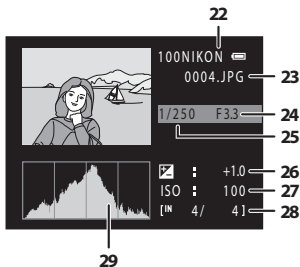

Parts of the Camera and Basic Operations

1	Date of recording	22
2	Time of recording	22
3	Voice memo indicator	80,
4	Battery level indicator	20
5	Protect icon	80
6	Print order icon	80
7	Image mode	71
8	Movie options	91
9	Easy panorama	49
10	(a) Current image number/ total number of images	30
	(b) Movie length	92
11	Internal memory indicator	30
	Easy panorama playback guide	49,
12	Sequence playback guide	51,
	Movie playback guide	92
	Voice memo playback guide	80,
13	Voice memo recording guide	80,

14	Volume indicator	80, 92,
15	D-Lighting icon	80
16	Quick retouch icon	80
17	Filter effects icon	80
18	Small picture icon	80
19	Skin softening icon	80
20	Sequence icon	51
21	File number and type	
22	Folder name	
23	File number and type	
24	Aperture value	28
25	Shutter speed	28
26	Exposure compensation value	65, 68
27	ISO sensitivity	37
28	Current image number/ total number of images	30
29	Histogram*	

* A histogram is a graph showing the distribution of tones in the image. The horizontal axis corresponds to pixel brightness, with dark tones to the left and bright tones to the right. The vertical axis shows the number of pixels.

Basic Operations

Switching Between Shooting Mode and Playback Mode

The camera has two modes of operation: Shooting mode, which is used for taking pictures, and playback mode, which is used for viewing pictures.

To switch between playback mode and shooting mode, press the  (playback) button.

- While using playback mode, you can also switch to shooting mode by pressing the shutter-release button or the  (movie-record) button.

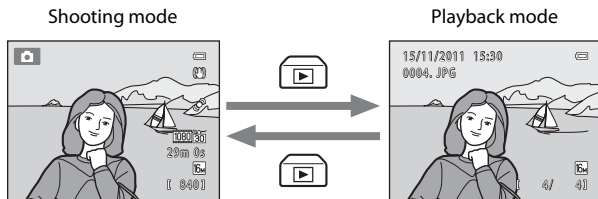

- Rotate the mode dial and align an icon to the mark to select a shooting mode ( 24-25).

Using the Rotary Multi Selector

Rotate the rotary multi selector, press the top (▲), bottom (▼), left (◀), or right (▶) edges of its surface, and the **OK** button.

- The rotary multi selector is sometimes referred to as “the multi selector” in this manual.

In Shooting Mode

Rotates to select an item*.

Displays  (self-timer) (59) menu.

Applies the current selection.

Displays  (macro mode) (64) menu.

Displays  (flash mode) (56) menu.

Displays the creative slider (65).

Displays  (exposure compensation) (68) guide.

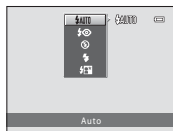

* Items can also be selected by pressing up or down.

In Playback Mode

Selects the previous image, moves the displayed area when the image is magnified (31)¹.



Displays the histogram and shooting information (8), plays back movies (92)².

Selects the next image, moves the displayed area when the image is magnified (31)¹.

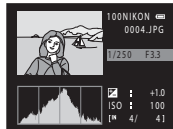
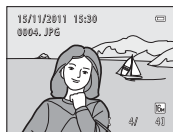

¹ Previous or subsequent images can also be selected by rotating the rotary multi selector.

² When displaying image thumbnails or when the image is magnified, this button switches the camera to full-frame display.

When Displaying Menus

Selects the item to the left, returns to the previous screen.

Applies the current selection (next screen is displayed).

Selects the item below*.



Selects the item above*.

Selects the item to the right, continues to the next screen (current selection is applied).

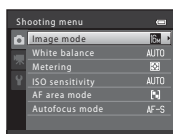

* Items can also be selected by rotating the rotary multi selector.

Using Menus (the MENU Button)

If you press the **MENU** button while the shooting screen or playback screen is displayed, the menu for the current mode is displayed. Once the menu is displayed, you can change various settings.

Shooting mode

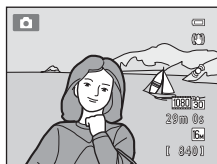

MENU

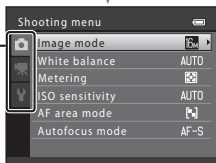

Tab

tab:
Displays the settings that can be changed for the current shooting mode (📖 24). Depending on the current shooting mode, the tab icon that is displayed will be different.

tab:
Displays movie recording settings.

tab:
Displays the setup menu, where you can change a number of general settings.

Playback mode

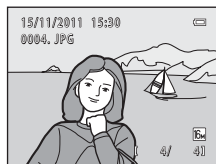

MENU

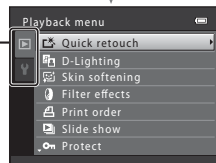

Tab

tab:
Displays the settings that can be changed for the playback mode (📖 30).

tab:
Displays the setup menu, where you can change a number of general settings.

If Tabs Are Not Displayed

If you press the **MENU** button and the screen that allows you to change the image mode is displayed, press the rotary multi selector to display the tabs.

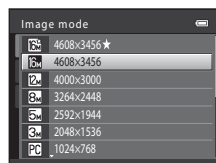

Switching Between Tabs

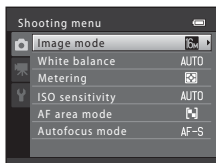

Press the rotary multi selector ◀ to highlight the tab.

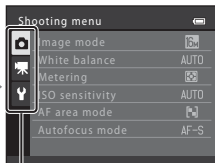

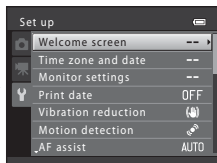

Press the rotary multi selector ▲ or ▼ to select a tab, and press either the  button or ▶.



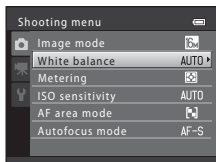

The selected menu is displayed.

Selecting Menu Items

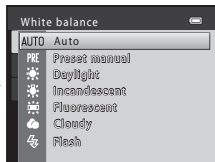

Press the rotary multi selector ▲ or ▼ to select an item, and then press ▶ or the  button. You can also select an item by rotating the rotary multi selector.



Press ▲ or ▼ to select an item and then press the  button.

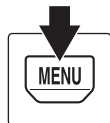

When you are finished changing settings, press the MENU button to exit the menu.

When the Menu Contains Two or More Pages

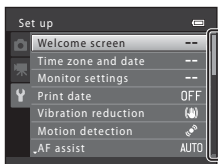

A guide indicating the page position is displayed.

Attaching the Camera Strap

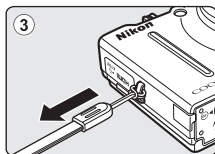
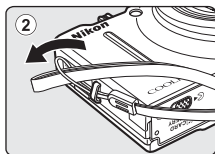
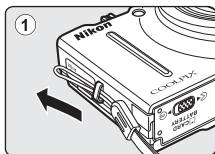

The Basics of Shooting and Playback

Preparation

Preparation 1 Insert the Battery	14
Preparation 2 Charge the Battery	16
Preparation 3 Insert a Memory Card	18



Shooting

Step 1 Turn the Camera On	20
Setting the Display Language, Date, and Time (First Use After Purchase)	22
Step 2 Select a Shooting Mode	24
Step 3 Frame a Picture	26
Step 4 Focus and Shoot	28



Playback

Step 5 Play Back Images	30
Step 6 Delete Unwanted Images	32

Preparation 1 Insert the Battery

- 1 Open the battery-chamber/memory card slot cover.

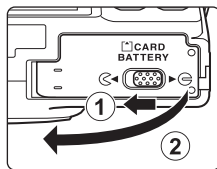

- 2 Insert the included EN-EL12 battery (rechargeable Li-ion battery).

- Use the battery to push the orange battery latch up in the direction indicated by the arrow (1), and fully insert the battery (2).
- When the battery is inserted correctly, the battery latch will lock the battery in place.

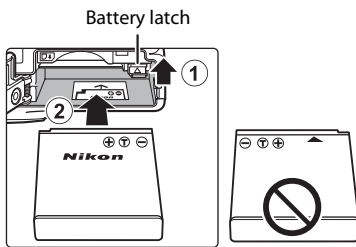

✓ Inserting the Battery Correctly

Inserting the battery upside down or backwards could damage the camera. Be sure to check that the battery is in the correct orientation.

- 3 Close the battery-chamber/memory card slot cover.

- Charge the battery before the first use or when the battery is running low (16).
- While the battery-chamber/memory card slot cover is open, the camera cannot be turned on. Additionally, the battery inserted in the camera cannot be charged.

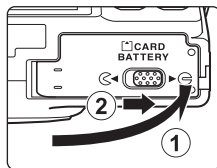

Removing the Battery

Turn the camera off and be sure that the power-on lamp and the monitor have turned off before opening the battery-chamber/memory card slot cover.

To eject the battery, open the battery-chamber/memory card slot cover and slide the orange battery latch up in the direction indicated by the arrow (①). The battery can then be removed by hand (②). Do not pull it at an angle.

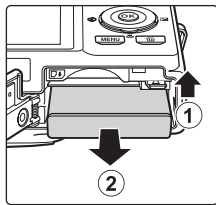

✔ High Temperature Caution

The camera, battery, and memory card may be hot immediately after using the camera. Observe caution when removing the battery or memory card.

✔ Notes About the Battery

Be sure to read and follow the warnings for the battery on page vii and in “The Battery” (⚙️4) before use.

Preparation 2 Charge the Battery

1 Prepare the included Charging AC Adapter EH-69P.

If a plug adapter* is included with your camera, attach the plug adapter to the plug on the Charging AC Adapter. Push the plug adapter firmly until it is securely held in place. Once the two are connected, attempting to forcibly remove the plug adapter could damage the product.

* The shape of the plug adapter varies according to the country or region in which the camera was purchased.

The Charging AC Adapter comes with the plug adapter attached in Argentina, Brazil, and Korea.

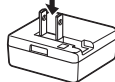
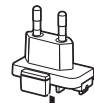
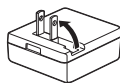

2 Make sure the battery is inserted in the camera, and then connect the camera to the Charging AC Adapter in order of ① to ③.

- Keep the camera turned off.
- When connecting the cable, be sure that the plug is properly oriented. Do not use force when connecting the cable to the camera. When disconnecting the cable, do not pull the plug at an angle.
- Close the battery-chamber/memory card slot cover.

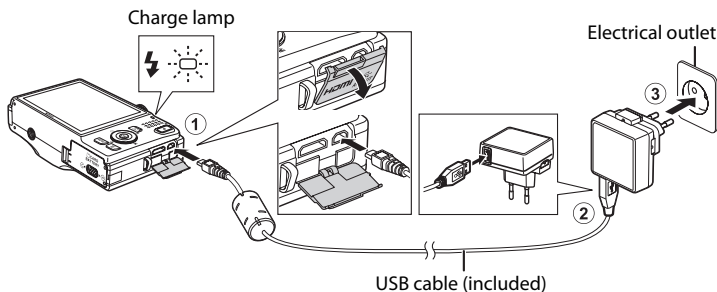

- The charge lamp slowly blinks green to indicate that the battery is charging.
- About four hours are required to charge a fully exhausted battery.
- When the battery has been completely charged, the charge lamp turns off.
- See “The Charge Lamp” (📖 17) for more information.

3 Disconnect the Charging AC Adapter from the electrical outlet and then disconnect the USB cable.

- When the camera is connected to an electrical outlet with the Charging AC Adapter, the camera cannot be turned on.

The Charge Lamp

Status	Description
Blinks slowly (green)	The battery is charging.
Off	The battery is not charging. When charging is complete, the charge lamp stops blinking green and turns off.
Flickers (green)	<ul style="list-style-type: none"> The ambient temperature is not suited to charging. Charge the battery indoors with an ambient temperature of 5 °C to 35 °C (41 °F to 95 °F). The USB cable or Charging AC Adapter is not properly connected, or there is a problem with the battery. Disconnect the USB cable or unplug the Charging AC Adapter and correctly connect it again, or change the battery.

Notes About the Charging AC Adapter

Be sure to read and follow the warnings for the Charging AC Adapter EH-69P on page vii and in “Charging AC Adapter” (85) before use.

Charging Using Computer or Battery Charger

- You can also charge the Rechargeable Li-ion Battery EN-EL12 by connecting the camera to a computer (81, 75).
- The EN-EL12 can be charged without using the camera by using the Battery Charger MH-65 (available separately; 85).

Notes About an AC Power Source

- You can take pictures and play back images while using the AC Adapter EH-62F (available separately; 85) to power the camera from an electrical outlet.
- Do not, under any circumstances, use another make or model of AC adapter other than EH-62F. Failure to observe this precaution could result in overheating or damage to the camera.

Preparation 3 Insert a Memory Card

- 1 Be sure that the power-on lamp and the monitor are off and open the battery-chamber/memory card slot cover.

- Be sure to turn off the camera before opening the cover.

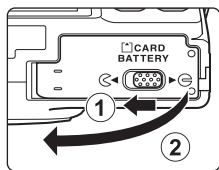

- 2 Insert the memory card.

- Slide the memory card in until it clicks into place.

✓ Inserting the Memory Card

Inserting the memory card upside down or backwards could damage the camera or the memory card. Be sure to check that the memory card is in the correct orientation.

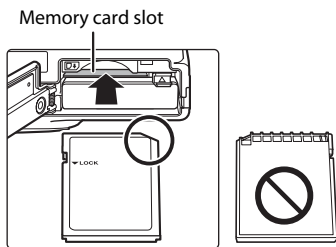

- 3 Close the battery-chamber/memory card slot cover.

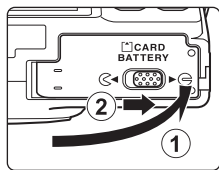

✓ Formatting a Memory Card

- The first time you insert a memory card that has been used in another device into this camera, be sure to format it with this camera.
- **All data stored on a memory card is permanently deleted when the card is formatted.** Be sure to transfer important images to a computer and save them before formatting.
- To format a memory card, insert the card into the camera, press the **MENU** button, and select **Format card** in the setup menu (📖 94).

✓ Notes About Memory Cards

See "Memory Cards" (🔍 5) and the documentation included with your memory card for more information.

Removing the Memory Card

Turn the camera off and be sure that the power-on lamp and the monitor have turned off before opening the battery-chamber/memory card slot cover.

Gently push the memory card into the camera (①) to partially eject the card, and then remove the card (②). Do not pull it at an angle.

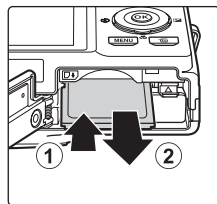

High Temperature Caution

The camera, battery, and memory card may be hot immediately after using the camera. Observe caution when removing the battery or memory card.

Internal Memory and Memory Cards

Camera data, including images and movies, can be saved in either the camera's internal memory (approximately 89 MB) or on a memory card. To use the camera's internal memory for shooting or playback, first remove the memory card.

Approved Memory Cards

The following Secure Digital (SD) memory cards have been tested and approved for use in this camera.

- Memory cards with an SD Speed Class rating of 6 or faster are recommended for recording movies. Movie recording may stop unexpectedly when memory cards with a lower Speed Class rating are used.

	SD memory card	SDHC memory card ²	SDXC memory card ³
SanDisk	2 GB ¹	4 GB, 8 GB, 16 GB, 32 GB	64 GB
TOSHIBA	2 GB ¹	4 GB, 8 GB, 16 GB, 32 GB	64 GB
Panasonic	2 GB ¹	4 GB, 8 GB, 12 GB, 16 GB, 32 GB	48 GB, 64 GB
Lexar	–	4 GB, 8 GB, 16 GB, 32 GB	–

¹ If the memory card will be used with a card reader or similar device, make sure that the device supports 2 GB cards.

² SDHC compliant.

If the memory card will be used with a card reader or similar device, make sure that the device supports SDHC.



³ SDXC compliant.

If the memory card will be used with a card reader or similar device, make sure that the device supports SDXC.



- Contact the manufacturer for details on the above cards. We cannot guarantee camera performance when using memory cards made by other manufacturers.

Step 1 Turn the Camera On

1 Press the power switch to turn on the camera.

- **If you are turning the camera on for the first time**, see “Setting the Display Language, Date, and Time” (📖 22).
- The lens extends and the monitor turns on.

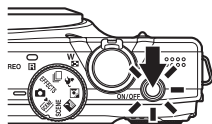

2 Check the battery level indicator and the number of exposures remaining.

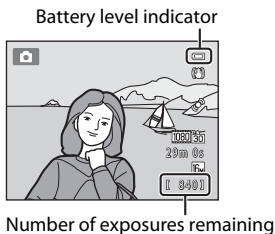

Battery Level Indicator

Display	Description
	The battery is fully charged.
	The battery is low. Prepare to charge or replace the battery.
 Battery exhausted.	The camera cannot take pictures. Recharge or replace with a fully charged battery.

Number of Exposures Remaining

The number of pictures that can be taken is displayed.

- is displayed when no memory card is inserted in the camera, and images will be saved in the internal memory (approx. 89 MB).
- The number of exposures remaining depends on the amount of available memory in the internal memory or memory card, and also varies depending on the image quality and image size (determined by the image mode setting; 📖 72).
- The number of remaining exposures shown in the illustrations in this manual are for example purposes only.

Turning the Camera On and Off

- The power-on lamp will light in green briefly then turn off, and then the monitor will turn on.
- To turn off the camera, press the power switch. When the camera turns off, the power-on lamp and the display turn off.
- To turn on the camera and switch to playback mode, press and hold the  (playback) button. The lens will not extend.

Power Saving Function (Auto Off)

If no operations are performed for a while, the monitor will turn off, the camera will enter standby mode, and the power-on lamp will blink. If no operations are performed for another three minutes, the camera will turn off automatically.

You can turn the monitor back on while the camera is in standby mode by performing any of the following:

- Press the power switch, shutter-release button,  (playback) button, or  (movie-record) button.
- Rotate the mode dial.

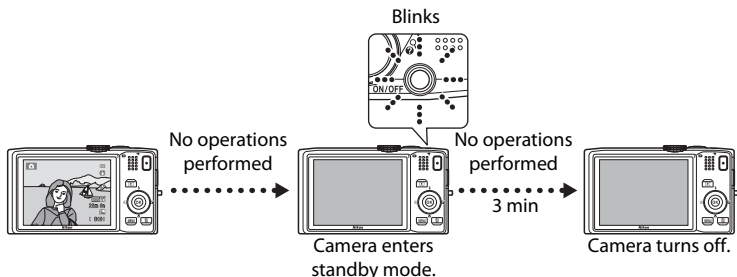

- The time that elapses before the camera enters standby mode can be changed using the **Auto off** setting in the setup menu ( 94).
- By default, the camera enters standby mode in about one minute when you are using shooting mode or playback mode.
- If you are using the optional AC Adapter EH-62F, the camera enters standby mode after 30 minutes.

Setting the Display Language, Date, and Time

When the camera is turned on for the first time after purchase, the language-selection screen and the date and time setting screen for the camera clock are displayed.

- 1 Press the multi selector ▲ or ▼ to select the desired language and press the OK button.

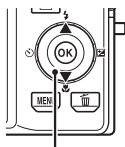

Multi selector

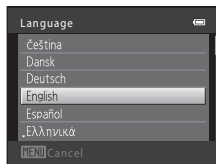

- 2 Press ▲ or ▼ to select **Yes** and press the OK button.

- To cancel without changing the setting, select **No**.

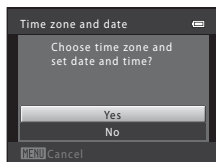

- 3 Press ◀ or ▶ to select your home time zone and press the OK button.

- See “Daylight Saving Time” (📖 23) for information about daylight saving time.

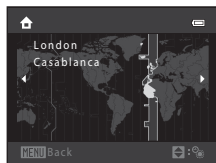

- 4 Press ▲ or ▼ to select the date format and press the OK button or ▶.

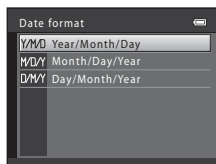

- 5 Press ▲, ▼, ◀, or ▶ to set the date and time, and press the OK button.

- Select an item: Press ▶ or ◀ (changes between **D, M, Y, hour**, and **minute**).
- Edit the highlighted item: Rotate the multi selector or press ▲ or ▼.
- Apply the setting: Select the **minute** setting and press the OK button or ▶.
- When settings are finished, the lens extends and the camera switches to shooting mode.

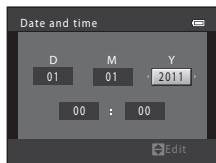



Daylight Saving Time

If daylight saving time is in effect, press the multi-selector ▲ to enable the daylight saving time function while setting the region in step 3. When the daylight saving time function is enabled, ☀️ is displayed at the top of the monitor.

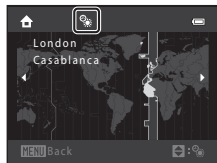
Press ▼ to disable the daylight saving time function.



Changing the Language Setting and the Date and Time Setting

- You can change these settings using the **Language** and **Time zone and date** settings in the  setup menu (📖 94).
- You can enable and disable daylight saving time by selecting **Time zone and date** and then **Time zone** in the  setup menu. When enabled, the clock moves forward one hour; when disabled, the clock moves back one hour. When the travel destination (➔) is selected, the time difference between the travel destination and the home time zone (🏠) is automatically calculated and the date and time in the selected region are saved at the time of shooting.
- If you exit without setting the date and time, ⌚ will blink when the shooting screen is displayed. Use the **Time zone and date** setting in the setup menu to set the date and time (📖 94).

The Clock Battery

- The camera's clock is powered by a backup battery that is separate from the camera's main battery.
- The backup battery charges when the main battery is inserted into the camera or when the camera is connected to an optional AC adapter, and can provide several days of backup power after about ten hours of charging.
- If the camera's backup battery becomes exhausted, the date and time setting screen is displayed when the camera is turned on. Set the date and time again. See step 2 of "Setting the Display Language, Date, and Time" (📖 22) for more information.

Imprinting the Shooting Date in Printed Images



- Set the date and time before shooting.
- You can permanently imprint the shooting date in images as they are captured by setting **Print date** in the setup menu (📖 94).
- If you want the shooting date to be printed without using the **Print date** setting, print using the ViewNX 2 software (📖 82).

Step 2 Select a Shooting Mode

Rotate the mode dial to select a shooting mode.

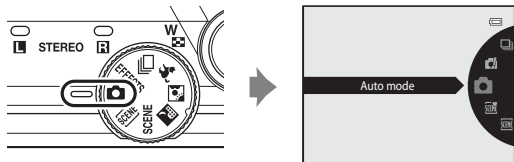
-  (auto) mode is used in this example. Rotate the mode dial to .



- The camera switches to  (auto) mode and the  icon is displayed.

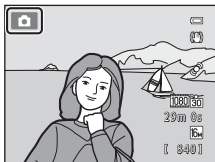

- See "Shooting Mode" (📖 6) in "The Monitor" for information about the shooting mode screen.

Available Shooting Modes

 **(Auto) mode** (📖 36)

Used for general shooting. Settings can be adjusted in the shooting menu (📖 37) to suit the shooting conditions and the type of shot you want to capture.

EFFECTS Special effects mode (📖 53)

Effects can be applied to images during shooting. Six different effects are available.

 **Continuous shooting mode** (📖 50)

Change settings to Continuous or BSS (best shot selector).

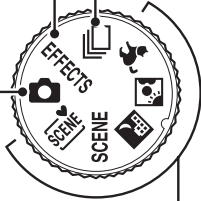

Scene mode (📖 39)

Camera settings are optimized according to the scene that you select.

 **(Scene auto selector)** : The camera automatically selects the optimum scene mode when you frame a picture, making it even easier to take pictures using settings that suit the scene.

SCENE : Select the desired scene from 15 different scene types, and the camera's settings are automatically optimized for the selected scene.

- To select a scene, first rotate the mode dial to **SCENE** and press the **MENU** button. Select the desired scene by pressing **▲** or **▼**, and then press the **OK** button.

 **(Night landscape)** : Captures the atmosphere of night landscapes.

 **(Backlighting)** : The flash fires when there is backlight to prevent the subject from being hidden in shadow, or use the HDR function to shoot when there are very bright areas and very dark areas in the same frame.

 **(Pet portrait)** : Use this mode when taking pictures of dogs or cats. When the camera detects the face of a dog or cat, the camera focuses on that face.

Features That Are Available in Shooting Mode

- The multi selector **▲** (🔍), **▼** (🔍), **◀** (🔍), and **▶** (🔍) can be used to set the corresponding features.
See “Features That Can Be Set Using the Multi Selector” (📖 55) for more information.
- Press the **MENU** button to display the menu for the selected shooting mode. See “Shooting Features” (📖 35) for information about the settings available in the menu for the current shooting mode.

Step 3 Frame a Picture

1 Hold the camera steady.

- Keep fingers, hair, the camera strap, and other objects away from the lens, flash, AF assist-illuminator, microphone, and speaker.
- When taking pictures in portrait (tall) orientation, turn the camera so that the flash is above the lens.

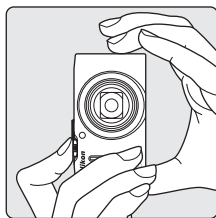
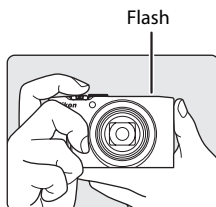

2 Frame the picture.

- Point the camera at the object (subject) you want to take a picture of.

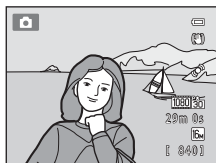

When Using a Tripod

- We recommend using a tripod to stabilize the camera in the following situations:
 - When shooting in dark surroundings with the flash mode (📖 57) set to  (off)
 - When zooming in on the subject
- Set **Vibration reduction** to **Off** in the setup menu (📖 94) when using a tripod to stabilize the camera during shooting.

Using the Zoom

Use the zoom control to activate optical zoom.

- To zoom in on the subject, rotate the zoom control to **T** (telephoto).
- To zoom out for a wider shot, rotate the zoom control to **W** (wide-angle). When you turn the camera on, the zoom moves to the maximum wide-angle position.
- Rotating the zoom control all the way in either direction will adjust the zoom quickly, while rotating the control partially will adjust the zoom slowly (except when recording movies).
- A zoom indicator is displayed at the top of the monitor when the zoom control is rotated.

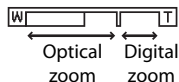
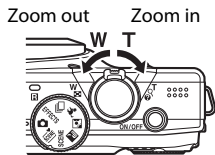

Digital Zoom

When the camera is zoomed in to the maximum optical zoom position, rotating and holding the zoom control at **T** triggers digital zoom.

Digital zoom can magnify the subject up to about 2× beyond the maximum magnification of the optical zoom.

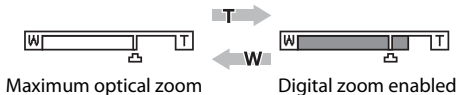



- When you are using digital zoom, the camera focuses on the subject in the center of the frame and the focus area is not displayed.

Digital Zoom and Interpolation

Unlike optical zoom, digital zoom uses a digital imaging process known as interpolation to magnify images, resulting in slight deterioration of picture quality according to the image mode (📖 71) and digital zoom magnification.

Interpolation is applied at zoom positions beyond  when taking still pictures.

When zoom is increased beyond the  position, interpolation is initiated and the zoom indicator turns yellow to indicate that interpolation is being applied.

The position of  moves to the right as image size decreases, allowing for confirmation of the zoom positions at which shooting without interpolation is possible at the current image mode setting.



- Digital zoom can be disabled from the **Digital zoom** option in the setup menu (📖 94).

Step 4 Focus and Shoot

1 Press the shutter-release button halfway, i.e., press the button slightly until you feel resistance.

- When you press the shutter-release button halfway, the camera sets the focus and exposure (shutter speed and aperture value). Focus and exposure remain locked while the shutter-release button is pressed halfway.
- When the camera detects the main subject, it focuses on that subject. When the subject is in focus, the focus areas (up to 12 areas) glow green.

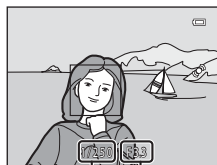
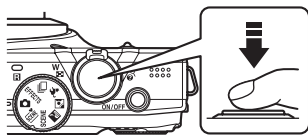

Shutter speed Aperture value

- The camera has nine focus areas, and if it does not detect the main subject, it automatically selects the focus areas containing the subject closest to the camera. When the subject is in focus, the focus areas that are in focus (up to nine areas) glow green.

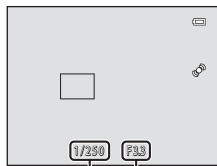

Shutter speed Aperture value

- When you are using digital zoom, the camera focuses on the subject in the center of the frame and the focus area is not displayed. When the camera has focused, the focus indicator (📷 6) glows green.
- While the shutter-release button is pressed halfway, the focus area or focus indicator may blink red. This indicates that the camera is unable to focus. Modify the composition and press the shutter-release button halfway again.
- If the subject is dimly lit when you press the shutter-release button halfway, the AF-assist illuminator (📷 95) may light and the flash (📷 2, 58) may pop-up.

2 Press the shutter-release button all the way, i.e., press the button the rest of the way down.

- The shutter is released and the image will be saved to the memory card or internal memory.
- If you press the shutter-release button with too much force, the camera may shake, causing images to be blurred. Press the button gently.



✓ Notes About Saving Images

- While images are being saved, the number of exposures remaining (📖 20) will blink. **Do not open the battery-chamber/memory card slot cover** while images are being saved. Removing the battery or memory card in these circumstances could result in loss of data or in damage to the camera or card.
- It may take some time for the image to be saved depending on the current settings or the shooting conditions (🔧:12).

✓ Autofocus

The camera may not focus as expected in the following situations. In some rare cases, the subject may not be in focus despite the fact that the focus area or the focus indicator glows green:

- Subject is very dark
- Objects of sharply differing brightness are included in the scene (e.g. the sun is behind the subject makes that subject appear very dark)
- No contrast between the subject and surroundings (e.g. a portrait subject, wearing a white shirt, is standing in front of a white wall)
- Several objects are at different distances from the camera (e.g. the subject is inside a cage)
- Subjects with repeating patterns (window blinds, buildings with multiple rows of similarly shaped windows, etc.)
- Subject is moving rapidly

In the situations noted above, try pressing the shutter-release button halfway to refocus several times, or focus on another subject positioned at the same distance from the camera as the actual desired subject, and use focus lock (📖 78).

📌 When the Subject Is Close to the Camera

If the camera cannot focus, try shooting with macro mode (📖 64) or the **Close-up** scene mode (📖 47).

📌 Flash

- If the subject is dimly lit, the flash will pop up automatically when you press the shutter-release button halfway when the flash mode is set to **⚡AUTO** (auto; default setting). The flash will fire when you press the shutter-release button all the way down. See “Using the Flash (Flash Mode)” (📖 56) for more information.
- To lower the flash, turn the camera off. See “Raising and Lowering the Flash” (📖 58) for more information.

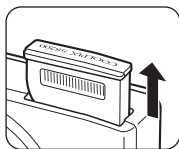

📌 To Make Sure You Do Not Miss a Shot

If you are concerned that you might miss a shot, press the shutter-release button all the way without first pressing it halfway.



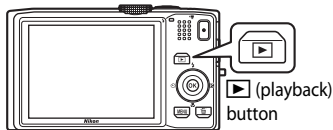

Step 5 Play Back Images

1 Press the (playback) button.

- When you switch from shooting mode to playback mode, the last image saved will be displayed full-frame.



2 Use the multi selector to select an image to display.

- To display previous images, press  or .
- To display subsequent images, press  or .
- You can also scroll through images by rotating the multi selector.



Display the previous image



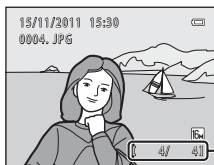

Display the subsequent image



Current image number/
total number of images



- Remove the memory card from the camera to play back images saved in the camera's internal memory.  is displayed near the current image number/total number of images display.
- To return to shooting mode, press the , shutter-release button, or  (movie-record) button.

Displaying Shooting Information

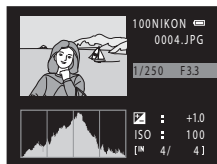
Press the  button in full-frame playback mode to display the histogram and shooting information ( 8). Press the  button again to return to full-frame playback mode.



Viewing Images

- Images may be displayed briefly at low resolution while being read from the memory card or internal memory.
- When images in which the face of a person ( 76) or a pet ( 43) was detected at the time of shooting are displayed in full-frame playback mode, depending upon the orientation of the detected face, the images may be automatically rotated for playback display (except when viewing images captured in a series).
- You can change the orientation of an image using **Rotate image** in the playback menu ( 80).

More Information

See "Features Available in Playback Mode (Playback Menu)" ( 80) for more information.

Changing How Images Are Displayed

When using playback mode, you can change how images are displayed by rotating the zoom control to **W** (📐) and **T** (🔍).



Playback Zoom

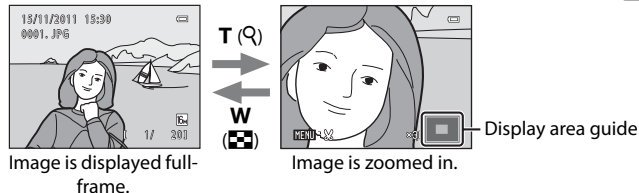

- You can change the zoom ratio by rotating the zoom control to **W** (📐) and **T** (🔍). Images can be zoomed up to 10x.
- To view a different area of the image, press the multi selector ▲, ▼, ◀, or ▶.
- If you are viewing an image that was captured using face detection (📖 76) or pet detection (📖 43), the camera zooms in on the face detected at the time of shooting (except when viewing an image captured in a series). If the camera detected multiple faces when the image was captured, press ▲, ▼, ◀, or ▶ to display a different face. To zoom in on an area of the image where there are no faces, adjust the magnification rate and then press ▲, ▼, ◀, or ▶.
- You can crop the image and save the displayed area of the image as a separate file by pressing the **MENU** button.
- Press the **OK** button to return to full-frame playback mode.

Thumbnail Display, Calendar Display

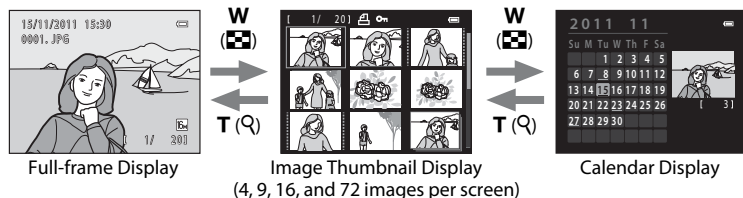





- You can view several images on one screen, making it easy to find the image you want.
- You can change the number of thumbnails displayed by rotating the zoom control to **W** (📐) and **T** (🔍).
- Rotate the multi selector or press ▲, ▼, ◀, or ▶ to select an image and then press the **OK** button to display that image full-frame.
- When 72 thumbnails are displayed, rotate the zoom control to **W** (📐) to switch to calendar display.
- While using calendar display mode, rotate the multi selector, or press ▲, ▼, ◀, or ▶ to select a date and then press the **OK** button to display the first image captured on that day.

Step 6 Delete Unwanted Images

- 1 Press the  button to delete the image currently displayed in the monitor.



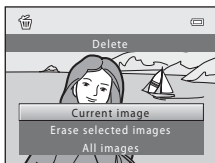

- 2 Press the multi selector  or  to select the desired deletion method and press the  button.

- **Current image:** The image currently displayed is deleted. If the key picture of a sequence ( 51) is selected, all images in the sequence are deleted.
- **Erase selected images:** Multiple images can be selected and deleted. See “Operating the Erase Selected Images Screen” ( 33) for more information.
- **All images:** All images are deleted.
- To exit without deleting the image, press the **MENU** button.



- 3 Press  or  to select **Yes** and press the  button.



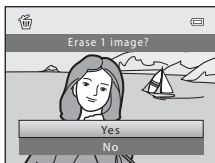

- Deleted images cannot be recovered.
- To cancel, press  or  to select **No** and press the .



Notes About Deletion

- Deleted images cannot be recovered. Copy important images to a computer before deleting them from the camera.
- Protected images ( 80) cannot be deleted.

Deleting Images Captured Using Continuous Shooting

- Each time images are captured continuously, they make up a group of images called a sequence, and by default only the first image of a sequence (called the “key picture”) is displayed to represent the sequence ( 7).
- When you press the **MENU** button during key picture playback, all images in the key picture’s sequence can be deleted ( 9).
- If you want to delete individual images in a sequence, press the  button before pressing the .

Deleting the Last Image Captured While in Shooting Mode

In shooting mode, press the  button to delete the last image that was saved.

Operating the Erase Selected Images Screen

1 Press the multi selector ◀ or ▶ to select an image to be deleted, and then press ▲ to display ✓.

- To undo the selection, press ▼ to remove ✓.
- Rotate the zoom control (L 2) to **T** (Q) to switch back to full-frame playback or **W** (E) to display thumbnails.



2 Add ✓ to all desired images and then press the **OK** button to confirm the selection.

- A confirmation dialog is displayed. Follow the instructions displayed in the monitor.



A series of horizontal dashed lines spanning the width of the page, intended for handwriting practice. There are 15 lines in total, starting from the top right and extending to the bottom left.

Shooting Features

This chapter describes the camera's shooting modes and the features that are available when using each shooting mode.

You can select shooting modes and adjust settings according to the shooting conditions and the kind of images you want capture.

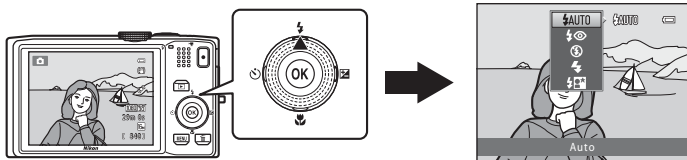
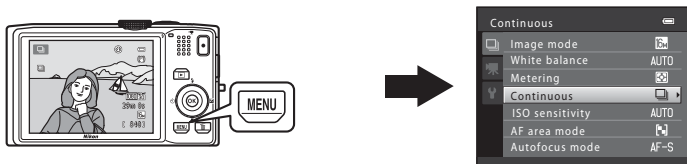
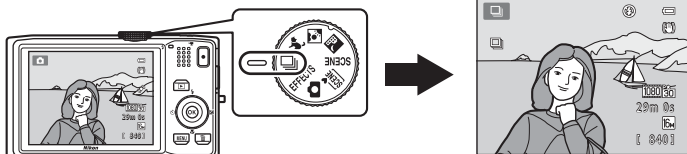

📷 (Auto) Mode

Used for general shooting. Settings can be adjusted in the shooting menu (📖 37) to suit the shooting conditions and the type of shot you want to capture.

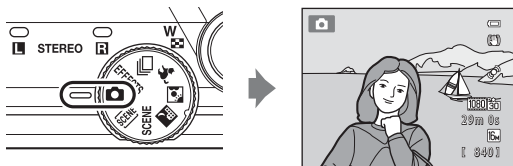

- You can change how the camera selects the area of the frame to focus on by pressing the **MENU** button, selecting the 📷 tab, and then selecting **AF area mode** (📖 37). The default setting is **Target finding AF**. When the camera detects the main subject, it focuses on that subject. When the camera does not detect the main subject, it automatically selects the focus areas (up to nine) that contain the subject closest to the camera. When the subject is in focus, the focus areas that are in focus (up to nine areas) glow green.

Changing 📷 (Auto) Mode Settings

- Features That Can Be Set Using the Multi Selector (📖 55): flash mode (📖 56), self-timer (📖 59), smile timer (📖 61), macro mode (📖 64), creative slider (📖 brightness (exposure compensation), 📖 vividness, 📖 hue) (📖 65)
- Features that can be set by pressing the **MENU** button: See “Options Available in the Auto Shooting Menu” (📖 37).

📎 Features That Cannot Be Used Simultaneously

Some settings cannot be used with other functions (📖 73).

Options Available in the Auto Shooting Menu



When using (auto) mode, the following settings can be changed.

Select (auto) mode → MENU button → tab (📖 11)

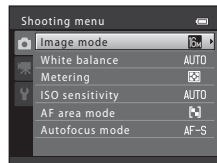
- The same items can be set when using continuous shooting mode (📖 50). Other than the continuous shooting type, items share the same settings with continuous shooting mode, and the settings are saved in the camera's memory even if the camera is turned off.



Option	Description	
Image mode	Allows you to select the combination of image size and image quality used when saving images (📖 71). This setting is also applied to other shooting modes.	71
White balance	Allows you to adjust the color tones of the image to match what you see with your eye. Although Auto (default setting) can be used in most shooting conditions, if the desired color tones are not achieved, adjust white balance to suit the sky conditions or light source. <ul style="list-style-type: none"> When white balance is set to settings other than Auto or Flash, set the flash mode (📖 56) to off (🔴). 	30
Metering	Allows you to select the method that the camera uses to measure the brightness of the subject. The camera adjusts the exposure, which is a combination of shutter speed and aperture value, based on the brightness measurement.	33
ISO sensitivity	Higher ISO sensitivity allows darker subjects to be captured. By increasing the shutter speed, this feature can also reduce blurring caused by camera shake and subject movement even when shooting in adequately lit conditions. When ISO sensitivity is set to Auto (default setting), the camera sets the ISO sensitivity automatically, and ISO is displayed while shooting when ISO sensitivity increases.	34
AF area mode	Allows you to determine how the camera selects the focus area that is used for autofocus; the available settings are Face priority , Auto , Manual , Center , and Target finding AF (default setting). When using Target finding AF , if the camera detects the main subject, it focuses on that subject.	37

Option	Description	
Autofocus mode	When Single AF (default setting) is selected, the camera focuses only while the shutter-release button is pressed halfway. When Full-time AF is selected, the camera focuses even when the shutter-release button is not pressed halfway. You may hear the sound of the camera focusing.	 42

 **Features That Cannot Be Used Simultaneously**

Some settings cannot be used with other functions ( 73).

Scene Mode (Shooting Suited to Scenes)



When one of the following scenes is selected in the scene menu or by rotating the mode dial, camera settings are automatically optimized for the selected scene.

(Scene auto selector) (40)

The camera automatically selects the optimum scene mode when you frame a picture.

































Night landscape (41) Backlighting (42) Pet portrait (43)

Rotate the mode dial to , or  and take pictures.



SCENE

Press the **MENU** button to display the scene menu and select one of the following shooting scenes.

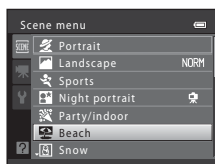
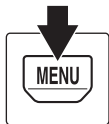
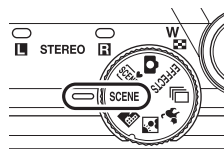
 Portrait (default setting) ( 44)	 Landscape ( 44)
 Sports ( 45)	 Night portrait ( 45)
 Party/indoor ( 46)	 Beach ( 46)
 Snow ( 46)	 Sunset ( 46)
 Dusk/dawn ( 46)	 Close-up ( 47)
 Food ( 47)	 Museum ( 48)
 Fireworks show ( 48)	 Black and white copy ( 48)
 Panorama ( 49)	



To View a Description (Help Display) of Each Scene

Select the desired scene from the scene menu and rotate the zoom control ( 2) to **T** () to view a description of that scene. To return to the original screen, rotate the zoom control to **T** () again.

Changing Scene Mode Settings

- Depending on the scene, the multi selector , , , and can be used to set the corresponding features. See “Features That Can Be Set Using the Multi Selector” (📖 55) and “Default Settings” (📖 69) for more information.
- Features that can be set by pressing the **MENU** button: **Image mode**, which is the combination of image size and image quality (📖 71).
- When using (night landscape), (backlighting), or (pet portrait), press the **MENU** button to set the **Image mode** or any of the options available in the current mode’s shooting menu.

Characteristics of Each Scene

Scene auto selector

The camera automatically selects the optimum scene mode when you frame a picture.

: Portrait, : Landscape, : Night portrait, : Night landscape, : Close-up, : Backlighting, : Other scenes

- When the camera selects a scene mode, the shooting mode icon displayed in the shooting screen changes to that for the scene mode currently enabled.
- The area of the frame that the camera focuses on (AF area) depends on the composition of the picture. The camera detects and focuses on human faces.
- Depending upon shooting conditions, the camera may not select the desired scene mode. Should this occur, switch to (auto) mode (📖 24) or select the desired scene mode manually.
- Digital zoom cannot be used.

If Night Landscape or Night Portrait Is Selected When Shooting with Scene Auto Selector



- If the camera switches to (night landscape) when using scene auto selector, the camera shoots images continuously and combines and saves them as one image, just as when **Hand-held** is selected when using (night landscape; 📖 41).
- If the camera switches to (night portrait) when using scene auto selector, the flash mode is fixed at red-eye reduction and the flash is used for capturing portraits (images are not captured continuously) just as when **Tripod** is selected when using **Night portrait** (📖 45).

 Night landscape

Captures the atmosphere of night landscapes.

Press the **MENU** button to set **Night landscape** to **Hand-held** or **Tripod**.



- **Hand-held** (default setting): Select this option to produce shots with reduced blurring and noise even when the camera is hand-held.
 - The  icon is displayed in the shooting screen.
 - When the shutter-release button is pressed all the way, the camera captures a series of images which will be combined into a single image and saved.
 - Once the shutter-release button is pressed all the way, hold the camera steady without moving it until a still image is displayed. After taking a picture, do not turn the camera off before the monitor switches to the shooting screen.
 - The angle of view (i.e., the area visible in the frame) seen in the saved image will be narrower than that seen in the monitor at the time of shooting.
- **Tripod**: Select this option when using a tripod or other means to stabilize the camera during shooting.
 - The  icon is displayed in the shooting screen.
 - **Vibration reduction** (📖 94) is automatically set to **Off** regardless of the setting in the setup menu.
 - One image is captured at a slow shutter speed when the shutter-release button is pressed all the way.
- The focus area or focus indicator (📖 6) always glows green when the shutter-release button is pressed halfway.

Backlighting

Use when light is coming from behind the subject, throwing features or details into shadow. Press the **MENU** button to set HDR (high dynamic range) compositing using the **HDR** setting according to the shooting conditions and subject.

- When **HDR** is set to **Off** (default setting): The flash fires to prevent the subject from being hidden in shadow.
 - The camera focuses on the area in the center of the frame.
 - One image is captured when the shutter-release button is pressed all the way.









- When **HDR** is set to **Level 1-Level 3**: Use when taking pictures with very bright and dark areas in the same frame. Select **Level 1** when there is less difference between bright and dark areas, and **Level 3** when there is more difference between bright and dark areas.
 - The **HDR** icon is displayed in the shooting screen.
 - The camera focuses on the area in the center of the frame.
 - When the shutter-release button is pressed all the way, the camera shoots images continuously at high speed, and saves the following two images.
 - A non-HDR composite image
 - An HDR composite image in which the loss of details in highlights or shadows is minimized
 - The second image saved is an HDR composite image. If there is only enough memory to save one image, an image processed by D-Lighting (📖 80) at the time of shooting, in which dark areas of the image are corrected, is the only image saved.
 - Once the shutter-release button is pressed all the way, hold the camera steadily without moving it until a still image is displayed. After taking a picture, do not turn the camera off before the monitor switches to the shooting screen.
 - The angle of view (i.e., the area visible in the frame) seen in the saved image will be narrower than that seen in the monitor at the time of shooting.
 - Depending on the shooting conditions, dark shadows may appear around bright subjects and bright areas may appear around dark subjects. You can compensate by lowering the level setting.



Pet portrait

Use this mode when taking pictures of dogs or cats. When the camera detects the face of a dog or cat, the camera focuses on that face. Once the camera has focused, by default it automatically releases the shutter (pet portrait auto release).



- Press the **MENU** button to set **Pet portrait** to **Single** or **Continuous**.
 - **Single**: Images are captured one at a time.
 - **Continuous** (default setting): Three images are captured continuously when a face is focused on (at a rate of about three fps when image mode is  **4608x3456**). While **Continuous** is selected, the  is displayed in the shooting screen.
- When the camera detects a face, a double border (focus area) is displayed around the face, and the double border glows green when the camera has focused. The faces of up to five pets can be detected at the same time. When the camera detects more than one face, the face displayed largest in the monitor is framed by a double border and the others by single borders.
- If no pet faces are detected, the shutter can be released by pressing the shutter-release button.
 - If no pet faces are detected, the camera focuses on the subject in the center of the frame.
 - When **Continuous** is selected, up to five images are captured continuously at a rate of about three fps (when image mode is set to  **4608x3456**) while the shutter-release button is held all the way down. Shooting ends when the shutter-release button is released.
- Press the multi selector  to change auto release settings.
 - **Pet portrait auto release** (default setting): The camera automatically releases the shutter when it focuses on the detected face. While **Pet portrait auto release** is selected, the  icon is displayed in the shooting screen.
 - **Off**: The shutter is released only when the shutter-release button is pressed.
- Digital zoom cannot be used.
- Depending on the distance of the pet from the camera, the speed of the pet's movement, the direction the pet is facing, the ambient brightness of the pet's face, etc., pet faces may not be detected and other subjects may be displayed with a border.
- **Pet portrait auto release** is automatically set to **Off** in the following situations.
 - When five series of images are captured using auto release
 - When there is no remaining space in the internal memory or on the memory card
 To continue using **Pet portrait auto release** to take more pictures, press the multi selector  and change the setting again.

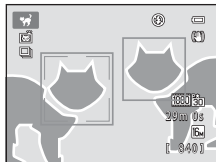

Scene Mode (Shooting Suited to Scenes)

SCENE → Portrait

Use this mode for portraits.

- When the camera detects a human face, it focuses on that face (📖 76).
- The camera softens skin tones by applying the skin softening function before saving images (📖 77).
- If no faces are detected, the camera focuses on the subject at the center of the frame.
- Digital zoom cannot be used.



SCENE → Landscape

Use this mode for vivid landscapes and cityscapes.

From the screen displayed after the  **Landscape** scene mode is selected, select **Noise reduction burst** or **Single shot**.

- **Noise reduction burst:** Crisp landscapes are captured in images with low noise.
 - The  icon is displayed in the shooting screen.
 - When the shutter-release button is pressed all the way, the camera shoots images continuously at high speed, and combines and saves them as one image.
 - Once the shutter-release button is pressed all the way, hold the camera steady without moving it until a still image is displayed. After taking a picture, do not turn the camera off before the monitor switches to the shooting screen.
 - The angle of view (i.e., the area visible in the frame) seen in the saved image will be narrower than that seen in the monitor at the time of shooting.
- **Single shot** (default setting): The camera saves an image with emphasized lines and contrast.
 - One image is captured when the shutter-release button is pressed all the way.
- The focus area or focus indicator (📖 6) always glows green when the shutter-release button is pressed halfway.



SCENE → 🏆 Sports

Use this mode when shooting sporting events. The camera captures a series of still images that allow you to clearly see detailed movements in a moving subject.

- The camera focuses on the area in the center of the frame.
- Press and hold the shutter-release button all the way to capture images continuously. Up to five images are captured continuously at a rate of about six fps (when image mode is set to [6]).
- The camera focuses even when the shutter-release button is not pressed halfway. You may hear the sound of the camera focusing.
- Focus, exposure, and hue are fixed at the values determined with the first image in each series.
- The frame rate with continuous shooting may vary depending upon the current image mode setting, the memory card used, or shooting condition.



SCENE → 🌃 Night portrait

Use this mode for evening and night portraits that include background scenery. The flash fires to light the portrait subject while preserving background lighting to achieve a natural balance between the main subject and background ambience.

From the screen displayed after the 🌃 **Night portrait** scene mode is selected, select **Hand-held** or **Tripod**.

- **Hand-held:**
 - The 🌃 icon is displayed in the shooting screen.
 - When shooting against a dark background, press the shutter-release button all the way to capture a series of images which will be combined into a single image and saved.
 - Once the shutter-release button is pressed all the way, hold the camera steady without moving it until a still image is displayed. After taking a picture, do not turn the camera off before the monitor switches to the shooting screen.
 - If the subject moves while the camera is shooting continuously, the image may be distorted, overlapped, or blurred.
- **Tripod** (default setting): Select this option when using a tripod or other means to stabilize the camera during shooting.
 - The 🌃 icon is displayed in the shooting screen.
 - **Vibration reduction** (📖 94) is automatically set to **Off** regardless of the setting in the setup menu.
 - One image is captured at a slow shutter speed when the shutter-release button is pressed all the way.
- The camera detects and focuses on a human face (📖 76).
- The camera softens skin tones by applying the skin softening function before saving images (📖 77).
- If no faces are detected, the camera focuses on the subject in the center of the frame.
- Digital zoom cannot be used.



Scene Mode (Shooting Suited to Scenes)

SCENE → Party/indoor

Suitable for taking pictures at parties. Captures the effects of candlelight and other indoor background lighting.

- The camera focuses on the area in the center of the frame.
- To avoid the effects of camera shake, hold the camera steady when shooting in dark surroundings. Set **Vibration reduction to Off** in the setup menu ( 94) when using a tripod to stabilize the camera during shooting.



SCENE → Beach

Captures the brightness of such subjects as beaches or sunlit expanses of water.

- The camera focuses on the area in the center of the frame.



SCENE → Snow

Captures the brightness of sunlit snow.

- The camera focuses on the area in the center of the frame.



SCENE → Sunset



Preserves the deep hues seen in sunsets and sunrises.

- The focus area or focus indicator ( 6) always glows green when the shutter-release button is pressed halfway.





SCENE → Dusk/dawn



Preserves the colors seen in the weak natural light before sunrise or after sunset.

- The focus area or focus indicator ( 6) always glows green when the shutter-release button is pressed halfway.



 Use of a tripod is recommended when using scene modes indicated with . Set **Vibration reduction to Off** in the setup menu ( 94) when using a tripod to stabilize the camera during shooting.

SCENE → 🌸 Close-up

Use this mode to photograph flowers, insects, and other small objects at close range.

- Macro mode (📖 64) is enabled and the camera automatically zooms to the closest position at which it can focus.
- You can move the area of the frame that the area focuses on (AF area). To move the AF area, press the **OK** button, and then rotate the multi selector or press **▲**, **▼**, **◀**, or **▶**.

To change settings for any of the following functions, first press the **OK** button to cancel focus-area selection, then change the settings as desired.

- Flash mode
- Self-timer
- Exposure compensation
- The camera focuses even when the shutter-release button is not pressed halfway. You may hear the sound of the camera focusing.



SCENE → 🍴 Food

Use this mode when taking pictures of food.

- Macro mode (📖 64) is enabled and the camera automatically zooms to the closest position at which it can focus.

- You can adjust hue by pressing the multi selector **▲** and **▼**. The hue setting is saved in the camera's memory even after the camera is turned off.
 - You can move the area of the frame that the area focuses on (AF area). To move the AF area, press the **OK** button, and then rotate the multi selector or press **▲**, **▼**, **◀**, or **▶**.
- To change settings for any of the following functions, first press the **OK** button to cancel focus-area selection, then change the settings as desired.

- Hue
- Self-timer
- Exposure compensation
- The camera focuses even when the shutter-release button is not pressed halfway. You may hear the sound of the camera focusing.

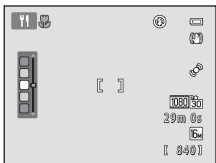

Scene Mode (Shooting Suited to Scenes)

SCENE → 🏛️ Museum

Use indoors where flash photography is prohibited (for example, in museums and art galleries) or in other settings in which you do not want to use the flash.

- The camera focuses on the area in the center of the frame.
- The camera captures a series of up to ten images while the shutter-release button is held all the way down, and the sharpest image in the series is automatically selected and saved (best shot selector; 📖 52).



SCENE → 🎆 Fireworks show



Slow shutter speeds are used to capture the light from fireworks.

- Camera focuses at infinity.
- The focus area or focus indicator (📖 6) always glows green when the shutter-release button is pressed halfway.
- Only the six optical zoom positions shown on the right can be applied. When the zoom control is rotated, zoom will not stop at any position other than the six indicated (digital zoom is available).

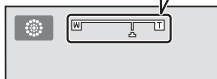
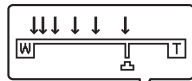

SCENE → 🖨️ Black and white copy

Provides clear images of text or drawings on a whiteboard or in print.

- The camera focuses on the area in the center of the frame.
- Use together with macro mode (📖 64) when shooting subjects that are close to the camera.

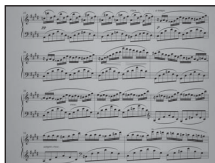

📖: Use of a tripod is recommended when using scene modes indicated with 📖. Set **Vibration reduction to Off** in the setup menu (📖 94) when using a tripod to stabilize the camera during shooting.

SCENE → 🏠 Panorama



Use this mode to take panorama pictures.

From the screen displayed after the 🏠 **Panorama** scene mode is selected, select **Easy panorama** or **Panorama assist**.

- **Easy panorama** (default setting): By simply moving the camera in the desired direction, panoramas that can be played back using the camera can be taken.
 - You can set the shooting range to **Normal (180°)** or **Wide (360°)**.
 - Press the shutter-release button all the way and release it, and then slowly move the camera horizontally. Shooting ends automatically when the selected shooting range has been captured.
 - The camera focuses on the area in the center of the frame when shooting begins.
 - The zoom position is fixed at the maximum wide-angle position.
 - When viewing an image captured using easy panorama in full-frame playback mode, press the **OK** button to display the short edge of the image using the entire monitor and automatically move (scroll) the displayed area.

See “Using Easy Panorama (Shooting and Playback)” (🔗2) for more information.

See “Playing Back Images With Easy Panorama (Scroll Playback)” (🔗4) for more information.

- **Panorama assist**: Use this setting to capture a series of images that will be connected using a computer to form a panorama image.
 - Press the multi selector **▲**, **▼**, **◀** or **▶** to select the direction that you will move the camera in when capturing images, and press the **OK** button.
 - After shooting the first image, confirm on the screen how the captured image will be connected to the next image, and shoot the next image. Shoot as many images as needed to complete the panorama. To finish shooting, press the **OK** button.
 - Transfer the images to your computer and use the included Panorama Maker 5 (📖 83, 🔗6) software to combine the images into a single panorama image.
- See “Using Panorama Assist” (🔗5) for more information.

✔ Notes About Printing Panoramas

When printing panoramas, the entire image may not be able to be printed depending on the printer's settings. Additionally, printing may not be possible depending on the printer.

See the documentation provided with the printer or consult the digital photo lab for details.

Continuous Shooting Mode (Burst Shooting)

Use this mode to capture the details of a moving subject by shooting a continuous series of images.

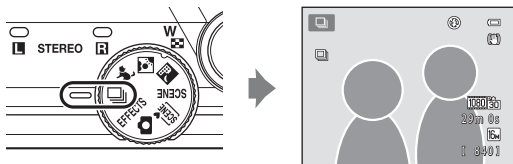

1 Press the **MENU** button and confirm or change the settings in the continuous menu.

- See “Continuous Menu” (52) for more information.
- Press the **MENU** button after changing the settings and return to the shooting screen.

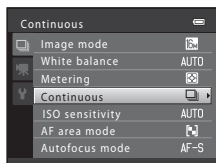

2 Frame the subject and shoot.

- By default, when the camera detects the main subject, it focuses on that subject. If the camera does not detect the subject, the camera selects the focus areas (up to nine areas) containing the subject closest to the camera.
- Press the shutter-release button halfway to lock focus and exposure.
- When **Continuous**, **Pre-shooting cache**, or **BSS** is selected in the continuous menu, images are captured while the shutter-release button is held all the way down.
- When **Continuous H: 120 fps**, **Continuous H: 60 fps**, or **Multi-shot 16** is selected in the continuous menu, the number of images determined by the setting are captured when the shutter-release button is pressed all the way. There is no need to hold the shutter-release button down.
- The focus, exposure, and white balance settings are fixed at the values for the first image in each series.
- After shooting, the camera returns to the shooting screen. If  is displayed, do not turn the camera off.

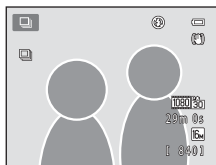

✓ Notes About Continuous Shooting Mode

- It may take some time to save the images after shooting. The amount of time it takes to finish saving the captured images depends on the number of images, image mode, the write speed of the memory card, etc.
- When ISO sensitivity increases, noise may appear in captured images.
- The speed of continuous shooting may decrease depending on the image mode, type of memory card used, and shooting conditions.
- When continuous is set to **Pre-shooting cache**, **Continuous H: 120 fps**, **Continuous H: 60 fps**, or **Multi-shot 16**, banding or variance in brightness or hue may occur in images that were captured under lighting that flickers at high speeds, such as fluorescent, mercury-vapor, or sodium-vapor lighting.

✎ Images Captured in Continuous Shooting Mode

Each time you capture images when continuous is set to **Continuous**, **Pre-shooting cache**, **Continuous H: 120 fps**, **Continuous H: 60 fps**, or smile timer continuous, the captured images are saved as a “sequence” (📷7).

Changing Continuous Shooting Mode Settings

- Features That Can Be Set Using the Multi Selector (📖 55): smile timer continuous (📖 61), macro mode (📖 64), creative slider (📷 brightness (exposure compensation), 🎛️ vividness, 🎛️ hue) (📖 65)
- Features that can be set by pressing the **MENU** button: See “Options Available in the Continuous Shooting Menu” (📖 52).

✎ Features That Cannot Be Used Simultaneously

Some settings cannot be used with other functions (📖 73).

Options Available in the Continuous Shooting Menu

You can select the type of continuous shooting in the continuous shooting menu, in addition to the options (📖 37) that are available when using 📷 (auto) mode, such as image mode and white balance.

Enter shooting mode → MENU button → 📷 tab (📖 11)

- For items not related to continuous shooting, see “Options Available in the Auto Shooting Menu” (📖 37).
- Other than the continuous shooting type, items share the same settings with 📷 (auto) mode, and the settings are saved in the camera’s memory even if the camera is turned off.

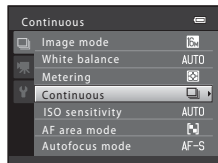

Option	Description	📖
📷 Continuous (default setting)	While the shutter-release button is held all the way down, up to five pictures are taken at a rate of about 6 frames per second (fps) (when Image mode is set to 📷 4608x3456).	📷 35
📷 Pre-shooting cache	Pre-shooting cache makes it easy to capture perfect moments, by saving images from before the shutter-release button was pressed all the way. Pre-shooting cache shooting begins when the shutter-release button is pressed halfway, and continues when the shutter-release button is pressed all the way. Shooting ends when the shutter-release button is released or when the maximum number of frames has been shot.	📷 35
📷 1/20 Continuous H: 120 fps	Each time the shutter-release button is pressed all the way, 60 frames are captured at a speed of about 1/125 s or faster.	📷 35
📷 1/60 Continuous H: 60 fps	Each time the shutter-release button is pressed all the way, 60 frames are captured at a speed of about 1/60 s or faster.	📷 35
📷 BSS BSS (best shot selector)	The “best shot selector” is recommended when shooting with the flash off or the camera zoomed in, or in other situations in which inadvertent motion can result in blurred images. The camera captures a series of up to ten images while the shutter-release button is held all the way down, and the sharpest image in the series is automatically selected and saved.	📷 35
📷 Multi-shot 16	Each time the shutter-release button is pressed, the camera takes 16 shots at a rate of about 30 fps and arranges them in a single image.	📷 36



Special Effects Mode (Applying Effects When Shooting)

Effects can be applied to images during shooting.

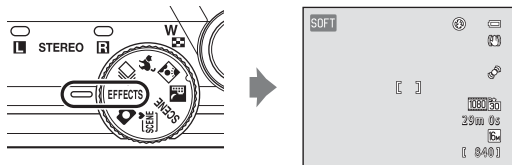

The following six effects are available.

Option	Description
SOFT Soft (default setting)	Softens the image by adding a slight blur to the entire image.
SEPIA Nostalgic sepia	Adds a sepia tone and reduces the contrast to simulate the qualities of an old photograph.
<input type="checkbox"/> High-contrast monochrome	Changes the image to black and white and gives it sharp contrast.
HI High key	Gives the entire image a bright tone.
LO Low key	Gives the entire image a dark tone.
Selective color	Creates a black and white image in which only the specified color remains.

- 1 Press the **MENU** button to display the special effects menu, use the multi selector to select **Special effects**, and then press the **OK** button.

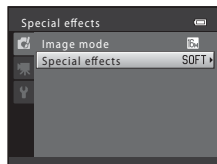

- 2 Press **▲** or **▼** to select an effect and press the **OK** button.
 - Press the **MENU** button after changing the settings and return to the shooting screen.

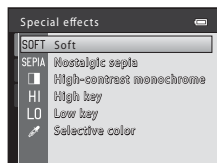

3 Frame the subject and shoot.

- The camera focuses on the area in the center of the frame.
- When **Selective color** is selected in step 2, rotate the multi selector or press ▲ or ▼ to select the desired color from the slider.

To change settings for any of the following functions, first press the **OK** button to cancel color selection, then change the settings as desired:

- Flash mode (📖 56)
- Self-timer (📖 59)
- Macro mode (📖 64)
- Exposure compensation (📖 68)

To return to the color selection screen, press the **OK** button again.

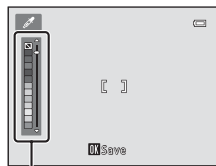

Slider



Changing Special Effects Mode Settings

- Features That Can Be Set Using the Multi Selector (📖 55): flash mode (📖 56), self-timer (📖 59), macro mode (📖 64), exposure compensation (📖 68)
- Features that can be set by pressing the **MENU** button: **Image mode**, which is the combination of image size and image quality (📖 71).

Features That Can Be Set Using the Multi Selector

When shooting, the multi selector ▲ (⚡), ▼ (🌸), ◀ (🕒), and ▶ (📏) can be used to set the following features.

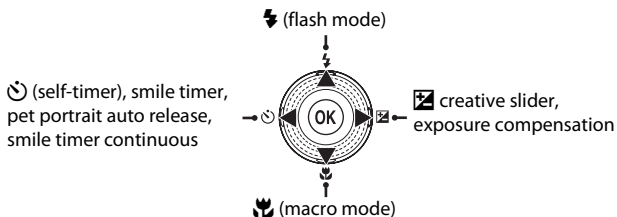

Available Features

The features that are available vary with the shooting mode, as shown below.

- See “Default Settings” (📖 69) for information about each mode’s default settings.

	📷	SCENE, 🏠, 🐾	📄	EFFECTS
⚡ Flash mode (📖 56)	✓	*	-	✓
🕒 Self-timer (📖 59) Smile timer (📖 61) Pet portrait auto release (📖 43) Smile timer continuous (📖 61)	✓		-	✓
	✓		-	-
	-		-	-
🌸 Macro mode (📖 64)	✓		✓	✓
📏 Creative slider (📏 brightness (exposure compensation), 🌟 vividness, 🎨 hue) (📖 65) Exposure compensation (📖 68)	✓		✓	-
	-		-	✓

* Varies by the scene. See “Default Settings” (📖 69) for more information.

Using the Flash (Flash Mode)

You can set the flash mode to match the shooting conditions.

- 1 Press the multi selector ▲ (⚡ flash mode).

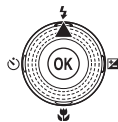

- 2 Use the multi selector to select the desired mode and press the OK button.

- See “Available Flash Modes” (📖 57).
- If a setting is not applied by pressing the OK button within a few seconds, the selection will be canceled.
- When **⚡AUTO** (auto) is applied, **⚡AUTO** is only displayed for a few seconds, regardless of **Monitor settings** (📖 94).

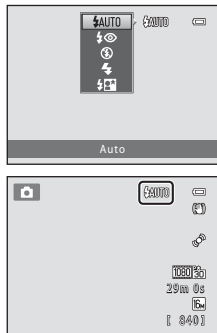

- 3 Frame the subject and take a picture.



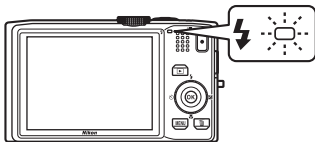

- See “Raising and Lowering the Flash” (📖 58).
- The flash lamp indicates the status of the flash when you press the shutter-release button halfway.
 - On: The flash will fire when you press the shutter-release button all the way down.
 - Blinking: The flash is charging. The camera cannot take pictures.
 - Off: The flash will not fire when a picture is taken.
- If the battery is low, the monitor will turn off in order to save power while the flash is charging.



Effective Range of the Flash

When ISO sensitivity is set to **Auto**, the flash has a range of 0.5 to 5.5 m (1 ft 8 in. to 18 ft) at the maximum wide-angle zoom position and a range of 1.0 to 3.0 m (3 ft 4 in. to 9 ft 10 in.) at the maximum telephoto zoom position.

Available Flash Modes

 AUTO	Auto
	Flash fires automatically when lighting is dim.
	Auto with red-eye reduction
	Reduce “red-eye” in portraits caused by the flash.
	Off
	Flash will not fire even when lighting is dim. <ul style="list-style-type: none"> • We recommend using a tripod to stabilize the camera when shooting in dark surroundings.
	Fill flash
	Flash fires whenever a picture is taken. Use to “fill-in” (illuminate) shadows and backlit subjects.
	Slow sync
	Auto flash mode is combined with slow shutter speed. Suited to evening and night portraits that include background scenery. Flash illuminates main subject; slow shutter speeds are used to capture background at night or under dim lighting.

The Flash Mode Setting

- The setting varies with the shooting mode. See “Available Features” (📖 55) and “Default Settings” (📖 69) for more information.
- Some settings cannot be used with other functions (📖 73).
- The flash mode setting applied in  (auto) mode is saved in the camera’s memory even after the camera is turned off.

Red-eye Reduction

This camera uses **advanced red-eye reduction** (In-Camera Red-Eye Fix). If the camera detects red eye while saving an image, the affected area will be processed to reduce red-eye before the image is saved.

Note the followings when shooting.

- More time than usual is required to save images.
- Red-eye reduction may not produce the desired results in some situations.
- In extremely rare instances, areas not subject to red-eye may be affected by red-eye reduction processing; in these cases, select another flash mode and try again.

Raising and Lowering the Flash

The camera automatically raises and lowers the flash.

- Do not pull the flash up or push down on it.

Raising the Flash

When you press the shutter-release button halfway, the flash will pop up if the conditions required for flash shooting are met.

- When the flash fires automatically (⚡AUTO auto flash, ⚡👁 auto with red-eye reduction, or 📷 slow sync): If the subject is dimly lit during shooting, the flash automatically pops up when you press the shutter-release button halfway. The camera determines whether or not to pop up the flash based on the brightness of the subject and the settings used during shooting.
- 🚫 (off): When the flash is lowered, the flash does not pop up even if the shutter-release button is pressed halfway.
- ⚡ (fill flash): The flash automatically pops up when you press the shutter-release button halfway.

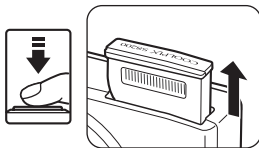

Lowering the Flash

To lower the flash, turn the camera off.

- Be careful not to pinch fingers or other objects.
- The flash cannot be lowered by pushing it down.

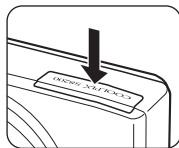



Using the Self-timer

The camera is equipped with a self-timer that releases the shutter ten or two seconds after you press the shutter-release button. The self-timer is useful when you want to be in the picture you are taking, and when you want to avoid the effects of camera shake that occur when you press the shutter-release button. When using the self-timer, use of a tripod is recommended. Set **Vibration reduction** to **Off** in the setup menu (📖 94) when using a tripod to stabilize the camera during shooting.

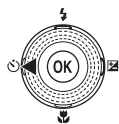
- 1** Press the multi selector ◀ (🕒 self-timer).



- 2** Use the multi selector to select **10s** or **2s** and press the **OK** button.

- **10s** (ten seconds): Use on important occasions, such as weddings.
- **2s** (two seconds): Use to prevent camera shake.
- When  is selected, the camera uses face detection to detect a human face, and then automatically releases the shutter when a smile is detected (📖 61).
- When the shooting mode is set to **Pet portrait** scene mode,  (pet portrait auto release) is displayed; when set to continuous shooting mode,  (smile timer continuous) is displayed (📖 43, 61). The self-timer settings **10s** and **2s** cannot be used.
- The mode selected for self-timer is displayed.
- If a setting is not applied by pressing the **OK** button within a few seconds, the selection will be canceled.



- 3** Frame the picture and press the shutter-release button halfway.

- Focus and exposure will be set.

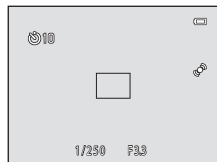

4 Press the shutter-release button the rest of the way down.

- The self-timer starts, and the number of seconds remaining before the shutter is released is displayed in the monitor. The self-timer lamp blinks while the timer is counting down. About one second before the shutter is released, the lamp stops blinking and glows steadily.
- When the shutter is released, the self-timer will be set to **OFF**.
- To stop the timer before a picture is taken, press the shutter-release button again.

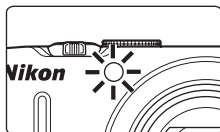
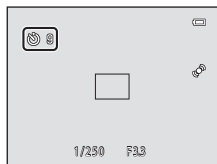

Using the Smile Timer, Smile Timer Continuous

When the camera detects a person's smile, it automatically releases the shutter; you do not need to press the shutter-release button.

- Smile timer: Images are captured one at a time. This feature can be used when shooting mode (📖 24) is set to 📷 (auto) mode or the **Portrait** or **Night portrait** scene mode (📖 39).
- Smile timer continuous: A continuous series of images is captured. This feature can be used when shooting mode (📖 24) is set to continuous shooting mode (📖 50).

1 Press the multi selector ◀ (🕒 self-timer).

- To adjust settings for creative slider, exposure compensation, or items in the shooting menu, adjust the settings before pressing 🕒.

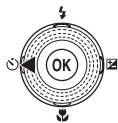

2 Use the multi selector to select 🕒 (smile timer or smile timer continuous) and press the OK button.

- If a setting is not applied by pressing the OK button within a few seconds, the selection will be canceled.

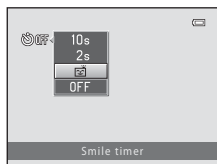

Smile timer

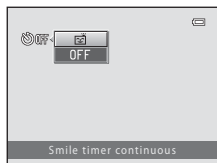

Smile timer continuous

3 Frame the picture and wait for the subject to smile.

- When the camera detects a human face, a double border (focus area) is displayed around that face. When the camera has focused on that face, the double border will turn green for a moment and focus is locked.
- Up to three faces can be detected. When the camera detects more than one face, the double border (focus area) is displayed around the face closest to the center of the frame, and single borders around the others.
- When using smile timer:
 - If the camera detects that the face framed by the double border is smiling, the shutter is automatically released.
 - After the camera releases the shutter, it will continue to detect faces and smiles, and will release the shutter again if it detects a smiling face.
 - To end automatic shooting by smile detection, set the smile timer to **OFF**.
- When using smile timer continuous:
 - The  icon is displayed in the shooting screen.
 - If the camera detects that the face framed by the double border is smiling, the shutter is automatically released and up to five images are captured at a rate of about 3 fps.
 - The camera will continue to detect faces and smiles until continuous shooting ends, and will capture images continuously again if it detects a smiling face. To finish, set the smile continuous timer to **OFF**.

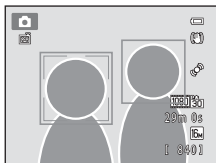

Notes About the Smile Timer, Smile Timer Continuous

- Digital zoom cannot be used.
- Under some shooting conditions, the camera may be unable to detect faces or detect smiles.
- See “Notes About Face Detection” (📖 76) for more information.
- This function cannot be used simultaneously with certain functions. See “Features That Cannot Be Used Simultaneously” (📖 73) for more information.

Auto Power Off When Using Smile Timer, Smile Timer Continuous

The auto off function (📖 95) is activated and the camera turns off when either of the situations indicated below persists and no other operations are performed.

- The camera does not detect any faces.
- The camera detected a face, but cannot detect a smile.

When the Self-timer Lamp Blinks

The self-timer lamp blinks slowly when the camera detects a face, and blinks quickly immediately after the shutter is released.

Releasing the Shutter Manually

Pictures can also be taken by pressing the shutter-release button. The camera focuses on the subject in the center of the frame when faces are not detected.

More Information

See “Autofocus” (📖 29) for more information.

Using Macro Mode

When using macro mode, the camera can focus on objects as close as 1 cm (0.4 in.) from the front of the lens.

This feature is useful when taking close-up pictures of flowers and other small subjects.

- 1 Press the multi selector ▼ (🌸 macro mode).

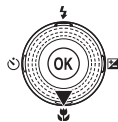

- 2 Use the multi selector to select **ON** and press the **OK** button.

- The macro mode icon (🌸) is displayed.
- If a setting is not applied by pressing the **OK** button within a few seconds, the selection will be canceled.

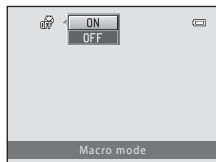

- 3 Rotate the zoom control to the zoom position at which 🌸 and the zoom indicator glow green.

- How close you can be to the subject when shooting depends on the zoom ratio.

When the zoom is set to a position where 🌸 and the zoom indicator glow green, the camera can focus on subjects as close as 10 cm (4 in.) from the lens.

When the zoom ratio is wider than 🌸, the camera can focus on subjects as close as 1 cm (0.4 in.) from the lens.

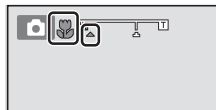

✓ Notes About Using the Flash

The flash may be unable to light entire subject at distances of less than 50 cm (1 ft 8 in.) from the camera.

✎ Autofocus

When using macro mode in 📷 (auto) mode or continuous shooting mode, you can focus without pressing the shutter-release button halfway by setting **Autofocus mode** (📖 38) in the shooting menu (📖 37) to **Full-time AF**.

When using other shooting modes, **Full-time AF** is turned on automatically when macro mode is turned on (except when using 🐾 (pet portrait)). You may hear the sound of the camera focusing.

✎ The Macro Mode Setting

- Macro mode cannot be used when using certain shooting modes. See "Default Settings" (📖 69) for more information.
- 📷 (auto) mode and continuous shooting mode share the same macro mode setting. When using 📷 (auto) mode or continuous shooting mode, the macro mode setting is saved in the camera's memory even if the camera is turned off.

Adjusting Brightness (Exposure Compensation), Vividness, and Hue (Creative Slider)

When the shooting mode (📖 24) is set to 📷 (auto) mode (📖 36) or continuous shooting mode (📖 50), use the creative slider to adjust brightness (exposure compensation), vividness, and hue for taking pictures.

Operating the Creative Slider

- 1 Press the multi selector ▶ (🔍).

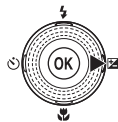

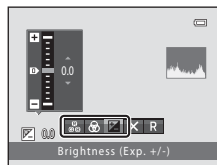

- 2 Press the multi selector ◀ or ▶ to select 📷, 📷, or 📷.





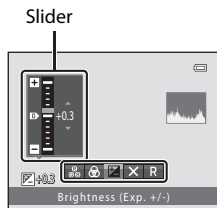

- 3 Adjust the brightness, vividness, or hue.

- Use the multi selector as explained below.
 - ▲▼: The slider moves. The effect can be adjusted while confirming the results in the monitor. The effect can also be adjusted by rotating the multi selector.
 - ◀▶: Switches between brightness (exposure compensation), vividness, and hue.
- For more information on each item, see the following:
 - "Adjusting Brightness (Exposure Compensation)" (📖 67)
 - "Adjusting Vividness (Saturation Adjustment)" (📖 67)
 - "Adjusting Hue (White Balance Adjustment)" (📖 67)
- To turn off the effects of the creative slider, press ◀ or ▶ to select **R**, and press the **OK** button.



4 When adjustment is complete, press ◀ or ▶ to select  and press the  button.

- If the  button (except when  is selected) or the shutter-release button is pressed in step 3, the selected amount of effect is applied. When the effect is applied, the camera returns to the shooting screen.
- If brightness is adjusted,  and the compensation value are displayed.
- If vividness is adjusted,  is displayed.
- If hue is adjusted,  is displayed.

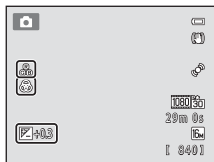
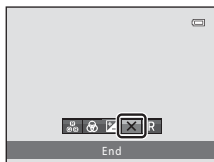

5 Press the shutter-release button to take a picture.

 **Creative Slider Settings**

 (auto) mode and continuous shooting mode share the same settings for brightness (exposure compensation), vividness, and hue; these settings are saved in the camera's memory even when the camera is turned off.

Adjusting Brightness (Exposure Compensation)

Adjust the overall brightness of the image.

- To make the subject brighter, move the slider toward “+.”
- To make the subject darker, move the slider toward “-.”

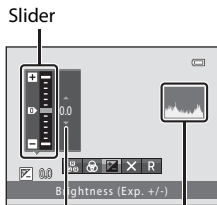

Exposure compensation value

Using the Histogram

A histogram is a graph showing the distribution of tones in the image. Use as a guide when using exposure compensation and shooting without the flash.

- The horizontal axis corresponds to pixel brightness, with dark tones to the left and bright tones to the right. The vertical axis shows the number of pixels.
- Increasing exposure compensation shifts tone distribution to the right, and decreasing it shifts tone distribution to the left.

Adjusting Vividness (Saturation Adjustment)

Adjust the overall vividness of the image.

- Vividness increases as the slider is moved up.
- Vividness decreases as the slider is moved down.

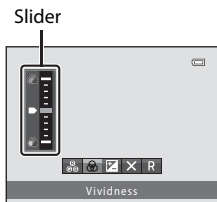

Adjusting Hue (White Balance Adjustment)

Adjust the overall hue of the image.

- The overall image becomes more reddish as the slider is moved up. The overall image becomes more bluish as the slider is moved down.

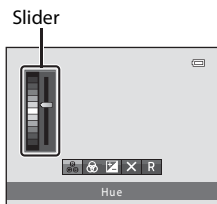

Notes About White Balance Adjustment

When hue is adjusted using the creative slider, **White balance** in the shooting menu  37 cannot be set. To set **White balance**, select **R** in the creative slider setting screen to reset the brightness, vividness, and hue.

Adjusting Brightness (Exposure Compensation)

When the shooting mode (📖 24) is set to scene mode (📖 39) or special effects mode (📖 53), you can adjust the brightness (exposure compensation).

- 1 Press the multi selector ► (📷 exposure compensation).

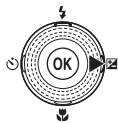

- 2 Use the multi selector to select a compensation value.
 - To make the subject brighter, apply positive (+) exposure compensation.
 - To make the subject darker, apply negative (-) exposure compensation.

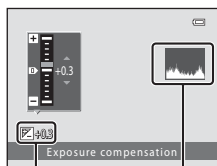

Exposure compensation value

Histogram

- 3 Press the **OK** button to apply the compensation value.
 - If you do not press the **OK** button within a few seconds, the setting will be applied and the menu will disappear.
 - When an exposure compensation value other than **0.0** is applied, the value is displayed with the 📷 indicator in the monitor.

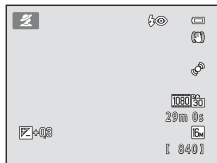

- 4 Press the shutter-release button to shoot.
 - To reset exposure compensation, repeat from step 1 and set the value to **0.0**.

📌 Notes About Exposure Compensation Value

When using the **Fireworks show** (📖 48) scene mode, exposure compensation is not available.

📌 Histogram

See "Using the Histogram" (📖 67) for more information.

Default Settings

Default settings for each shooting mode are described below.

- Information about scene mode can be found on the next page.

	Flash (📖 56)	Self-timer (📖 59)	Macro (📖 64)	Creative slider (📖 65)	Exposure compensation (📖 68)
📷 (auto)	🔦AUTO	Off ¹	Off	Off	–
📷 (continuous)	🔦 ²	Off ³	Off	Off	–
EFFECTS (special effects)	🔦	Off	Off	–	0.0

¹ You can turn the self-timer and smile timer (📖 61) on and off.







































² The setting cannot be changed.



³ Self-timer cannot be used. You can turn the smile timer continuous (📖 61) on and off.

- Settings applied in 📷 (auto) mode and continuous shooting mode are saved in the camera's memory even after the camera is turned off, except for the self-timer setting.



Features That Can Be Set Using the Multi Selector

Default settings for scene mode are described below.

	Flash (📖 56)	Self-timer (📖 59)	Macro (📖 64)	Exposure compensation (📖 65)
 (📖 40)	 AUTO ¹	Off	Off ²	0.0
 (📖 41)	 ²	Off	Off ²	0.0
 (📖 42)	 ³	Off	Off ²	0.0
 (📖 43)	 ²	 ⁴	Off	0.0
 (📖 44)	 ⁵	Off ⁵	Off ²	0.0
 (📖 44)	 ²	Off	Off ²	0.0
 (📖 45)	 ²	Off ²	Off ²	0.0
 (📖 45)	 ⁶	Off ⁵	Off ²	0.0
 (📖 46)	 ⁷	Off	Off ²	0.0
 (📖 46)	 AUTO	Off	Off	0.0
 (📖 46)	 AUTO	Off	Off	0.0
 (📖 46)	 ²	Off	Off ²	0.0
 (📖 46)	 ²	Off	Off ²	0.0
 (📖 47)	 ³	Off	On ²	0.0
 (📖 47)	 ²	Off	On ²	0.0
 (📖 48)	 ²	Off	Off	0.0
 (📖 48)	 ²	Off ²	Off ²	0.0 ²
 (📖 48)	 ²	Off	Off	0.0
 (📖 49)	 ⁸	Off ⁹	Off ⁸	0.0

¹  AUTO (auto) or  (off) can be selected. When  AUTO (auto) is selected, the camera automatically selects the flash mode appropriate for the scene it has selected.

² The setting cannot be changed.

³ Flash is fixed at  (fill flash) when **HDR** is set to **Off**, and is fixed at  (off) when **HDR** is set to other than **Off**.

⁴ Self-timer cannot be used. You can turn the pet portrait auto release (📖 43) on and off.

⁵ You can turn the self-timer and smile timer (📖 61) on and off.

⁶ The flash fires using red-eye reduction.

⁷ Slow sync with red-eye reduction flash mode may be used. The default setting can be modified.

⁸ Can be changed when using **Panorama assist**.

⁹ Self-timer can be used when using **Panorama assist**.

Features That Cannot Be Used Simultaneously















Some settings cannot be used with other functions (📖 73).

Changing the Image Size (Image Mode)

Enter shooting mode → MENU button → Shooting menu → Image mode

You can use the **Image mode** setting in the shooting menu to select the combination of image size and compression ratio that is used when saving images. Select the image mode best suited to the manner in which images will be used and the capacity of the internal memory or memory card. The higher the image mode setting, the larger the size at which it can be printed, but the number of images that can be saved is reduced.

Image Mode Settings (Image Size and Quality)

Option*	Description
 4608×3456★	Images will be higher quality than  . The compression ratio is approximately 1:4.
 4608×3456 (default setting)	Best choice in most situations. The compression ratio is approximately 1:8.
 4000×3000	
 3264×2448	
 2592×1944	
 2048×1536	Smaller size than  ,  ,  , or  allows more images to be saved. The compression ratio is approximately 1:8.
 1024×768	Suited to display on a computer monitor. The compression ratio is approximately 1:8.
 640×480	Suited to display on a TV with an aspect ratio of 4:3, or distribution by e-mail. The compression ratio is approximately 1:8.
 4608×2592	Images with an aspect ratio of 16:9 are saved. The compression ratio is approximately 1:8.

* The total number of pixels captured, and the number of pixels captured horizontally and vertically.

Example:  **4608×3456** = approx. 16 megapixels, 4608 × 3456 pixels

The icon for the current setting is displayed in the monitor in shooting and playback modes ( 6, 8).









Notes About Image Mode

- The setting is also applied to other shooting modes.
- Some settings cannot be used with other functions ( 73).

Changing the Image Size (Image Mode)

Number of Exposures Remaining

The following table lists the approximate number of images that can be saved in the internal memory and on a 4 GB memory card. Note that due to JPEG compression, the number of images that can be saved varies greatly depending on the composition of the image. In addition, this number may vary depending on the make of memory card, even when the memory cards have the same specified capacity.

Image mode	Internal memory (approx. 89 MB)	Memory card ¹ (4 GB)	Print size ² (cm/in.)
 4608×3456★	11	470	39 × 29/15 × 11
 4608×3456	19	840	39 × 29/15 × 11
 4000×3000	26	1110	34 × 25/13 × 10
 3264×2448	39	1650	28 × 21/11 × 8
 2592×1944	61	2560	22 × 16/8.5 × 6.5
 2048×1536	96	4020	17 × 13/7 × 5
 1024×768	299	12000	9 × 7/3.5 × 2.5
 640×480	813	30100	5 × 4/2 × 1.5
 4608×2592	26	1120	39 × 22/15 × 8.6

¹ If the number of exposures remaining is 10,000 or more, the number of exposures remaining display shows “9999”.

² Print size at an output resolution of 300 dpi. Print sizes are calculated by dividing the number of pixels by printer resolution (dpi) and multiplying by 2.54 cm (1 in.). However, at the same image size, images printed at higher resolutions will print smaller than the size indicated, and those printed at lower resolutions will print larger than the size indicated.

Features That Cannot Be Used Simultaneously

Some shooting settings cannot be used with other functions.

Restricted function	Setting	Description
Self-timer	AF area mode (📖 37)	When AF area mode is set to Subject tracking , self-timer cannot be used.
Continuous	Smile timer continuous (📖 61)	Smile timer continuous is used for shooting regardless of the Continuous setting.
Macro mode	AF area mode (📖 37)	When AF area mode is set to Subject tracking , macro mode cannot be used.
Image mode	Continuous (📖 50)	When using Pre-shooting cache , image mode is fixed at SM . When using Continuous H: 120 fps , image mode is fixed at VB . When using Continuous H: 60 fps , image mode is fixed at IM (image size: 1280×960 pixels). When using Multi-shot 16 , image mode is fixed at SM (image size: 2560×1920 pixels).
White balance	Hue (using the creative slider) (📖 65)	When hue is adjusted using the creative slider, White balance in the shooting menu cannot be set. To set White balance , select R in the creative slider setting screen to reset the brightness, vividness, and hue.
ISO sensitivity	Continuous (📖 50)	When shooting with Pre-shooting cache , Continuous H: 120 fps , Continuous H: 60 fps , or Multi-shot 16 , the ISO sensitivity setting is automatically set according to the brightness.

Features That Cannot Be Used Simultaneously

Restricted function	Setting	Description
AF area mode	Self-timer (📖 59)	When using Target finding AF , if you use the self-timer, the camera functions as when AF area mode is set to Auto .
	Smile timer, smile timer continuous (📖 61)	Face detection is used regardless of the AF area mode setting.
	Creative slider (📖 65)	When using Target finding AF , if vividness or hue is adjusted using the creative slider, the camera functions as when AF area mode is set to Auto .
	White balance (📖 37)	When using Target finding AF , if White balance is set to any setting other than Auto , the camera functions as when AF area mode is set to Auto .
Autofocus mode	Smile timer, smile timer continuous (📖 61)	When using smile timer or smile timer continuous, Autofocus mode is fixed at Single AF .
	AF area mode (📖 37)	When AF area mode is set to Face priority , AF area mode is fixed at Single AF .
Print date	Continuous (📖 50)	When shooting with Pre-shooting cache , Continuous H: 120 fps , or Continuous H: 60 fps , the shooting date is not imprinted.
Vibration reduction	Night landscape (📖 41)	When Vibration reduction is set to Tripod , it changes to Off .
	Night portrait (📖 45)	When Vibration reduction is set to Tripod , it changes to Off .
Motion detection	ISO sensitivity (📖 37)	When ISO sensitivity is fixed, Motion detection is disabled.
	AF area mode (📖 37)	When AF area mode is set to Subject tracking , Motion detection is disabled.
Digital zoom	Smile timer, smile timer continuous (📖 61)	Digital zoom cannot be used.
	AF area mode (📖 37)	When AF area mode is set to Subject tracking , digital zoom cannot be used.
	Continuous (📖 50)	When using Multi-shot 16 , digital zoom cannot be used.

Restricted function	Setting	Description
Blink warning	Smile timer, smile timer continuous (📖 61)	Blink warning does not function.
	Night portrait (📖 45)	When Hand-held is selected, blink warning is disabled.

✔ Notes About Digital Zoom

- Depending on the shooting mode or the current settings, digital zoom may not be available (📷70).
- When digital zoom is in effect, the camera focuses in the center of the frame. Additionally, metering automatically switches to center-weighted metering.

Using Face Detection

When the following shooting modes or settings are selected, the camera uses face detection to automatically focus on human faces. If the camera detects more than one face, a double border is displayed around the face that the camera will focus on, and single borders are displayed around the other faces.

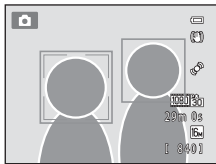

Shooting mode	Number of faces that can be detected	Focus area (double border)
When AF area mode (📖 37) in 📷 (auto) mode or continuous shooting mode is set to Face priority	Up to 12	The face closest to the camera
Scene auto selector, Portrait , or Night portrait scene mode (📖 39) is selected		
Smile timer, smile timer continuous (📖 61)	Up to 3	The face closest to the center of the frame

- When using **Face priority**, if you press the shutter-release button halfway while no faces are detected or while framing a shot with no faces in it, the camera selects the focus area (up to nine areas) containing the subject closest to the camera.
- When using scene auto selector, the focus area changes depending on which scene the camera selects.
- If no faces are detected when the shutter-release button is pressed halfway when using **Portrait** or **Night portrait**, the camera will focus on the subject in the center of the frame.

✔ Notes About Face Detection

- The camera's ability to detect faces depends on a variety of factors, including the direction in which the faces are looking. Additionally, the camera may be unable to detect faces in the following situations:
 - When faces are partially hidden by sunglasses or otherwise obstructed
 - When faces take up too much or too little of the frame
- When the frame includes more than one face, the faces detected by the camera and the face on which the camera focuses depend upon a variety of factors, including the direction in which the faces are looking.
- In some rare cases, such as those described in "Autofocus" (📖 29), the subject may not be in focus even though the double border turns green. Should this occur, change AF area mode to **Manual** or **Center** in 📷 (auto) mode, and try focus lock shooting (📖 78) by focusing on another subject that is the same distance from the camera.

✔ Viewing Images That Were Captured Using Face Detection

- During playback, the camera automatically rotates images according to the orientation of the faces that were detected at the time of shooting, except when viewing an image captured in a series.
- When zooming in on an image displayed full-frame by rotating the zoom control to **T** (📄), the image will be enlarged so that the face that was detected at the time of shooting is displayed in the center of the monitor (📖 31), except when viewing an image captured in a series.

Using Skin Softening

When the shutter is released when using one of the following shooting modes, the camera detects one or more human faces (up to three), and processes the image to soften facial skin tones before saving the image.

- **Scene auto selector** (📖 40), **Portrait** (📖 44), or **Night portrait** (📖 45) scene mode is selected.

Skin softening can also be applied to saved images (📖 80).

✔ Notes About Skin Softening

- It may take more time than usual to save images after shooting.
- Under some shooting conditions, the desired skin softening results may not be achieved, and skin softening may be applied to areas of the image where there are no faces. If the desired results are not produced, switch to another shooting mode and then try shooting again.

Focus Lock

You can use focus lock to focus on off-center subjects when center is selected for AF area mode.

The following procedure describes how to use focus lock when using  (auto) mode with **AF area mode** ( 37) set to **Center**.

1 Position the subject in the center of the frame.

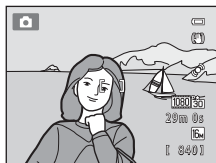

2 Press the shutter-release button halfway.

- Confirm that the focus area glows green.
- Focus and exposure are locked.

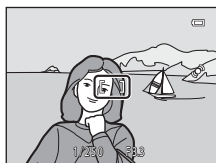

3 Continue holding down the shutter-release button halfway and recompose the picture.

- Be sure to maintain the same distance between the camera and the subject.

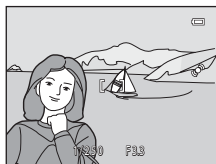

4 Press the shutter-release button the rest of the way down to take the picture.



Playback Features

This chapter describes the features that are available when playing back images.

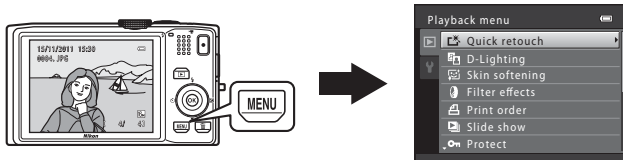

Features Available in Playback Mode (Playback Menu)

When viewing images in full-frame playback mode or thumbnail playback mode, you can select one of the following functions by pressing the **MENU** button (📖 11) to display the menu and then selecting the  tab.

Option	Description	
 Quick retouch*	Allows you to create retouched copies in which contrast and saturation have been enhanced.	 12
 D-Lighting*	Allows you to create copies with enhanced brightness and contrast, brightening dark portions of an image.	 13
 Skin softening*	When this feature is enabled, the camera detects faces in images and creates a copy with softer facial skin tones.	 14
 Filter effects*	Digital filter effects can be used to apply a variety of effects to images. Effect types include Cross screen , Fisheye , Miniature effect , and Painting .	 16
 Print order	When using a printer to print images saved on the memory card, you can use the Print order function to select which images are printed, and how many copies of each image are printed.	 43
 Slide show	Allows you to view images saved in the internal memory or on a memory card in an automatic slide show.	 46
 Protect	Protects selected images from accidental deletion.	 47
 Rotate image	Specifies the orientation in which saved images are displayed during playback.	 49
 Small picture*	Creates a small copy of the current image. This feature is useful for creating copies for display on Web pages or for e-mail attachments.	 18
 Voice memo	Allows you to use the camera's microphone to record voice memos and attach them to images. You can also play back and delete voice memos.	 50
 Copy	Allows you to copy images between the internal memory and a memory card.	 52
 Sequence display options	Allows you to display a sequence of images shot continuously as individual images, or display only the key picture of a sequence.	 54
 Choose key picture	Allows you to change the key picture that is displayed to represent a series of images shot continuously. See "Playing Back and Deleting Images Captured Continuously (Sequence)" (📖 7) for information about sequences.	 54

* Images are edited and saved as separate files. Certain restrictions apply (📖 10, 📖 11). For example, images captured at an **Image mode** (📖 71) setting of **4608x2592** cannot be edited, and the same editing feature cannot be applied multiple times.

Connecting the Camera to a TV, Computer, or Printer

You can enhance your enjoyment of images and movies by connecting the camera to a TV, computer, or printer.

- Before connecting the camera to an external device, make sure the remaining battery level is sufficient and turn the camera off. For information about the connection methods and subsequent operations, refer to the documentation included with the device in addition to this document.

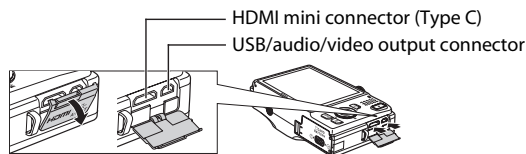

How to open the connector cover. Insert the plug straight.

Viewing images on a TV

 21

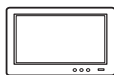

You can view the camera's images and movies on a TV.
Connection method: Connect the video and audio plugs of the included Audio Video Cable EG-CP16 to the TV's input jacks. Alternatively, connect a commercially available HDMI cable (Type C) to the TV's HDMI input jack.

Viewing and organizing images on a computer

 82



If you transfer images to a computer, you can perform simple retouching and manage image data in addition to playing back images and movies.
Connection method: Connect the camera to the computer's USB input jack with the included USB Cable UC-E6.

- Before connecting to a computer, install ViewNX 2 on the computer using the included ViewNX 2 Installer CD-ROM. For information about using the ViewNX 2 Installer CD-ROM and transferring images to a computer, see page 82.
- If any USB devices that draw the power from the computer are connected, disconnect them from the computer before you connect the camera to it.
- Connecting the camera and other USB-powered devices to the same computer simultaneously may cause a camera malfunction or excessive power supply from the computer, which could damage the camera or memory card.

Printing images without using a computer

 24



If you connect the camera to a PictBridge-compatible printer, you can print images without using a computer.
Connection method: Connect the camera directly to the printer's USB input jack with the included USB Cable UC-E6.

Using ViewNX 2

ViewNX 2 is an all-in-one software package which enables you to transfer, view, edit and share images.

Install ViewNX 2 using the ViewNX 2 Installer CD-ROM.



Installing ViewNX 2

- An Internet connection is required.

Compatible Operating Systems

Windows

- Windows 7 Home Basic/Home Premium/Professional/Enterprise/Ultimate
- Windows Vista Home Basic/Home Premium/Business/Enterprise/Ultimate (Service Pack 2)
- Windows XP Home Edition/Professional (Service Pack 3)

Mac OS

- Mac OS X (version 10.5.8, 10.6.7)

Refer to the Nikon website for the latest information on operating system compatibility.

- 1 Start the computer and insert the ViewNX 2 Installer CD-ROM into the CD-ROM drive.

- Mac OS: When the **ViewNX 2** window is displayed, double-click the **Welcome** icon.

2 Select a language in the language selection dialog to open the installation window.

- If the desired language is not available, click **Region Selection** to choose a different region and then choose the desired language (the **Region Selection** button is not available in the European release).
- Click **Next** to display the installation window.

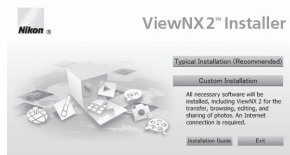
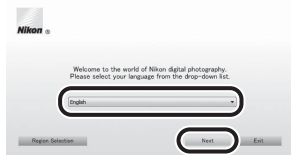

3 Start the installer.

- We recommend clicking **Installation Guide** in the installation window to check the installation help information and system requirements before installing ViewNX 2.
- Click **Typical Installation (Recommended)** in the installation window.

4 Download the software.

- When the **Software Download** screen is displayed, click **I agree - Begin download**.
- Follow the on-screen instructions to install the software.

5 Exit the installer when the installation completion screen is displayed.

- Windows: Click **Yes**.
- Mac OS: Click **OK**.

The following software is installed:

- ViewNX 2 (consisting of the three modules below)
 - Nikon Transfer 2: For transferring images to the computer
 - ViewNX 2: For viewing, editing, and printing transferred images
 - Nikon Movie Editor: For basic editing of transferred movies
- Panorama Maker 5 (for creating a single panorama photo using a series of images shot in panorama assist scene mode)
- QuickTime (Windows only)

6 Remove the ViewNX 2 Installer CD-ROM from the CD-ROM drive.

Transferring Images to the Computer

1 Choose how images will be copied to the computer.

Choose one of the following methods:

- **Direct USB connection:** Turn the camera off and ensure that the memory card is inserted in the camera. Connect the camera to the computer using the supplied USB Cable UC-E6. The camera automatically turns on.

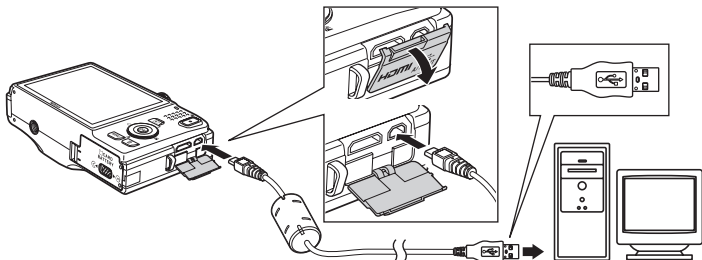

- **SD card slot:** If your computer is equipped with an SD card slot, the card can be inserted directly in the slot.
- **SD card reader:** Connect a card reader (available separately from third-party suppliers) to the computer and insert the memory card.

If a message is displayed prompting you to choose a program, select Nikon Transfer 2.

• When using Windows 7

If the dialog shown at right is displayed, follow the steps below to select Nikon Transfer 2.

- 1 Under **Import pictures and videos**, click **Change program**. A program selection dialog will be displayed; select **Import File using Nikon Transfer 2** and click **OK**.
- 2 Double-click **Import File**.

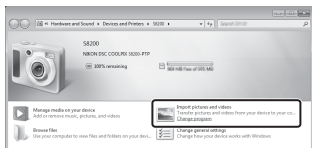

If the memory card contains a large number of images, it may take a while for Nikon Transfer 2 to start. Wait until Nikon Transfer 2 starts.

✓ Connecting the USB Cable

The connection may not be recognized if the camera is connected to the computer via a USB hub.

2 Transfer images to the computer.

- Confirm that the name of the connected camera or removable disk is displayed in the “Source” panel in the Nikon Transfer 2 “Options” area (①).
- Click **Start Transfer** (②).

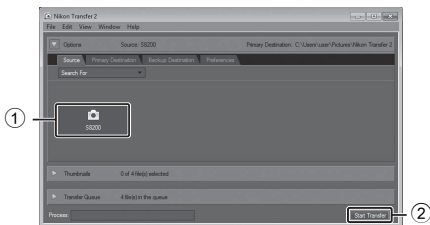

- At default settings, all the images on the memory card will be copied to the computer.

3 Terminate the connection.

- If the camera is connected to the computer, turn the camera off and disconnect the USB cable.
- If a card reader or card slot is used, choose the appropriate option in the computer operating system to eject the removable disk corresponding to the memory card and then remove the card from the card reader or card slot.

Viewing Images

Start ViewNX 2.

- Images are displayed in ViewNX 2 when transfer is complete.
- Consult online help for more information on using ViewNX 2.



Starting ViewNX 2 Manually

- **Windows:** Double-click the **ViewNX 2** shortcut icon on the desktop.
- **Mac OS:** Click the **ViewNX 2** icon in the Dock.

Retouching Photographs

Click **Edit** in the ViewNX 2 toolbar.



Image editing functions include tone compensation, sharpness adjustment, and trimming (cropping).

Editing Movies

Click **Movie Editor** in the ViewNX 2 toolbar.



Movie editing functions include the ability to delete unwanted scenes.

Printing Images

Click **Print** in the ViewNX 2 toolbar.

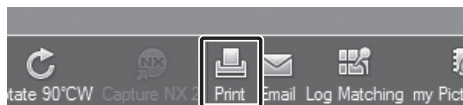

A dialog is displayed and images can be printed using a printer connected to the computer.

Recording and Playing Back Movies

You can record movies by simply pressing the  (movie-record) button.

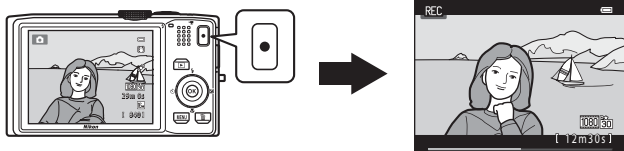

In playback mode, press the  button to play a movie.

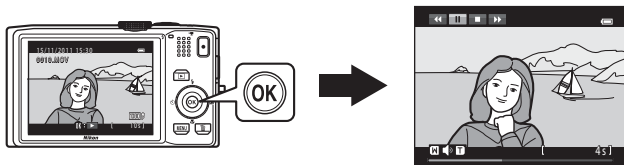

Recording Movies

You can record movies by simply pressing the **●** (▶ movie-record) button. Color tones, white balance, and other settings are the same when recording movies as they are when taking pictures.

1 Display the shooting screen.

- The icon for the selected movie option is displayed.
The default setting is **1080p HD 1080p★** (1920×1080) (91).
* The maximum movie length shown in the illustrations in this manual is for example purposes only.

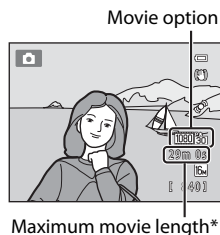

2 Press the **●** (▶ movie-record) button to start movie recording.

- The camera focuses in the center of the frame. Focus areas are not displayed during recording.
- When recording movies using **1080p** or a movie options setting with a 16:9 aspect ratio, the shooting screen changes to a 16:9 aspect ratio (the area indicated at right is recorded).
- If **Photo info in Monitor settings** (94) in the setup menu is set to **Movie frame+auto info**, the area that will be visible in the movie can be confirmed before movie recording starts.
- The approximate remaining movie length is displayed. **IN** is displayed while saving to the internal memory.
- Recording stops automatically when the maximum movie length has been recorded.



3 Press the **●** (▶ movie-record) button again to end recording.

✓ Notes About Saving Movies

After a movie has been recorded, it is not fully saved to the internal memory or memory card until the shooting screen is displayed. **Do not open the battery-chamber/memory card slot cover** before movies have been fully saved. Removing the memory card or the battery while a movie is being saved may result in loss of the movie data or damage to the camera or to the memory card.

✓ Notes About Movie Recording

- Memory cards with an SD Speed Class rating of 6 or faster are recommended when recording movies (📖 19). When using a memory card with a lower Speed Class rating, movie recording may stop unexpectedly.
- There may be some degradation in image quality when digital zoom is used. If the digital zoom is not being used when movie recording begins, rotating and holding the zoom control at **T** zooms the image using optical zoom and the zoom stops at the maximum optical zoom ratio. After letting go of the zoom control, rotate the zoom control to **T** again to magnify the image using the digital zoom.
- When recording ends, digital zoom turns off.
- The sounds of zoom control operation, zoom, autofocus lens drive movement, vibration reduction, and aperture operation when brightness changes may be recorded.
- The following phenomena may be seen in the monitor while recording movies. These phenomena are saved in the recorded movies.
 - Banding may occur in images under fluorescent, mercury-vapor, or sodium-vapor lighting
 - Subjects that move quickly from one side of the frame to the other, such as a moving train or car, may appear skewed
 - The entire movie image may be skewed when the camera is panned.
 - Lighting or other bright areas may leave residual images when the camera is moved

✓ Camera Temperature

- The camera may become warm when shooting movies for an extended period of time or when the camera is used in a hot area.
- If the inside of the camera becomes extremely hot when recording movies, the camera will automatically stop recording after 30 seconds. The amount of time remaining until the camera stops recording (🕒 30 s) is displayed. Five seconds after the camera stops recording, it turns itself off. Leave the camera off until the inside of the camera has cooled.

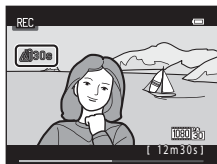





✓ Notes About Autofocus

Autofocus may not perform as expected, as explained in "Autofocus" (📖 29). Try the following methods when recording movies of these kinds of subjects.

1. Before shooting, set **Autofocus mode** to **AF-S Single AF** (default setting) in the movie menu.
2. Aim the camera so that another subject positioned the same distance from the camera as the desired subject is in the center of the monitor, press the **● (🎬 movie-record)** button, and then aim at the desired subject after recording starts.

Movie Options and Maximum Movie Length



Movie options (📖 91)	Internal memory (approx. 89 MB)	Memory card (4 GB) ²
 HD 1080p★ (1920×1080) (default setting)	37 s ¹	25 min
 HD 1080p (1920×1080)	57 s	40 min
 HD 720p (1280×720)	1 min 25 s	60 min
 iFrame 540 (960×540)	33 s ¹	25 min
 VGA (640×480)	4 min 11 s	3 h

All figures are approximate. The maximum movie length may vary depending on the make of the memory card, even among memory cards of the same capacity.

¹ The maximum movie length for a single movie is 25 seconds.

² Each movie is limited to a file size of 4 GB and a movie length of 29 minutes, even when there is sufficient free space on the memory card for longer recording. The maximum movie length that can be recorded for a single movie is displayed during recording.

Functions Available with Movie Recording



- The creative slider, white balance (when using  (auto) mode, continuous shooting mode), or exposure compensation settings are also applied when recording movies. The tone that results from using special effects mode (📖 53) or scene mode (📖 40) is also applied to movies. When macro mode is enabled, movies of subjects closer to the camera can be recorded. Confirm settings before starting movie recording.
- Set the self-timer (📖 59) and press the  (movie-record) button to start recording a movie after ten or two seconds.
- The flash will not fire.
- Press the **MENU** button to select the  (movie) tab and adjust movie menu settings before starting movie recording (📖 91).

Changing Movie Recording Settings (the Movie Menu)

Enter shooting mode → MENU button →  tab (📖 11)

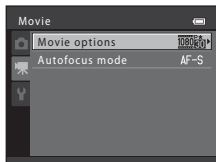
The following settings can be changed.



Option	Description	
Movie options	Select the desired movie option to record. The camera can record normal speed movies and high speed (HS) movies, which can be played back in slow motion or fast motion.	 55
Autofocus mode	Select the autofocus method used when recording normal speed movies. When AF-S Single AF (default setting) is selected, focus is locked when movie recording begins. When AF-F Full-time AF is selected, the camera focuses continuously while recording. When AF-F Full-time AF is selected, the sound of the camera focusing may be heard in recorded movies. If you want to prevent the sound of the camera focusing from being recorded, select AF-S Single AF .	 59

Playing Back Movies

Press the  button to enter playback mode.

Movies are indicated by the movie options icon ( 91).

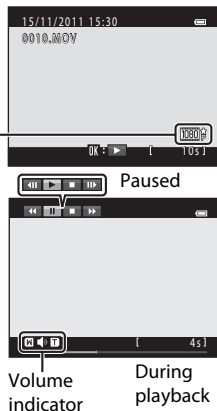

Press the  button to play back movies. Movie options



















Functions Available During Playback

Rotate the multi selector to advance or rewind the movie.

Playback controls are displayed at the top of the monitor.

Press the multi selector  or  to select a control. The operations described below are available.





Function	Icon	Description
Rewind		Hold down the  button to rewind the movie.
Advance		Hold down the  button to advance the movie.
Pause		Press the  button to pause playback. The following operations can be performed while playback is paused using the controls displayed at the top in the monitor.
		 Press the  button to rewind the movie. Hold down the  button for continuous rewinding.*
		 Press the  button to advance the movie. Hold down the  button for continuous advancing.*
		 Press the  button to resume playback.
End		Press the  button to return to full-frame playback mode.

* The movie can also be advanced or rewound by rotating the multi selector.

Adjusting volume

Rotate the zoom control to **T** or **W** ( 2) during playback.

Deleting movies

To delete a movie, select the desired movie in full-frame playback mode ( 30) or thumbnail playback mode ( 31) and press the  button ( 32).

Notes About Playing Back Movies

- The COOLPIX S8200 is not able to playback movies recorded with another make or model of digital camera.
- The histogram and shooting information are not displayed for movies ( 8).

General Camera Setup

This chapter describes the various settings that can be adjusted in the  setup menu.

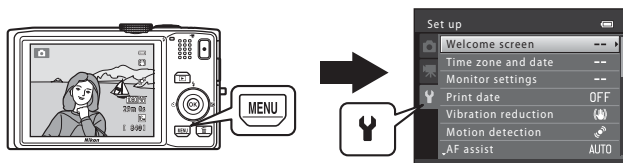

- See “Using Menus (the **MENU** Button)” (📖 11) for information about using the camera’s menus.
- For further details about each setting, refer to “The Setup Menu” in the Reference Section (🔧60).







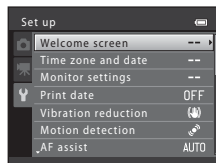







The Setup Menu

Press the **MENU** button → **Y** (setup) tab (📖 11)









From the menu screen, select the **Y** tab to display the setup menu, and then you can change the following settings.



Option	Description	📖
Welcome screen	Allows you to select the image displayed as the welcome screen when the camera is turned on. Select COOLPIX to display the COOLPIX logo. Select Select an image to use a picture taken with the camera as the welcome screen. The welcome screen is not displayed by default.	📖60
Time zone and date	Allows you to set settings related to the camera's date and time. The Time zone setting allows you to specify the time zone where the camera is mainly used and whether or not daylight saving time is in effect. When the travel destination (📍) is selected, the camera automatically calculates the time difference between the travel destination and the home time zone (🏠), and saves images using the date and time of the travel destination.	📖61
Monitor settings	Allows you to adjust settings related to the monitor. <ul style="list-style-type: none"> • Photo info allows you to select the kind of information that is displayed during shooting mode and playback mode. If you select Framing grid+auto info, a grid is displayed when shooting to help you frame the shot. • Brightness allows you to adjust the brightness of the monitor. 	📖64
Print date	Allows you to imprint the shooting date and time on images at the time of shooting. The default setting is Off . <ul style="list-style-type: none"> • The shooting date and time are not imprinted on images captured using Panorama or on movies. 	📖66
Vibration reduction	Allows you to reduce blurring caused by camera shake when shooting. The default setting is On . <ul style="list-style-type: none"> • When using a tripod to stabilize the camera during shooting, set this feature to Off to prevent this feature from malfunctioning. 	📖67

Option	Description	
Motion detection	<p>When set to Auto (default setting), if the camera detects camera shake or subject movement at the time of shooting, it automatically increases ISO sensitivity and shutter speed to reduce blurring. The  indicator glows green when the camera detects camera shake and increases shutter speed.</p> <ul style="list-style-type: none"> When using certain shooting modes or settings, motion is not detected. In these case the  indicator is not displayed. 	 68
AF assist	<p>When set to Auto (default setting), the AF-assist illuminator ( 2) lights when shooting in dark surroundings to help the camera focus.</p> <ul style="list-style-type: none"> The AF-assist illuminator has a range of about 2.2 m (7 ft 3 in.) at the maximum wide-angle position and about 1.4 m (4 ft 7 in.) at the maximum telephoto position. Even if Auto is selected, the AF-assist illuminator may not light depending on the position of the focus area or the scene mode that is selected. 	 69
Digital zoom	<p>When set to On (default setting), the digital zoom feature can be used by rotating the zoom control to T () to zoom in beyond the maximum optical zoom position ( 27).</p>	 70
Sound settings	<p>Allows you to turn various camera operation sounds on and off.</p> <ul style="list-style-type: none"> Camera operation sounds are not heard when using certain modes, such as  (pet portrait). 	 71
Auto off	<p>Allows you to set the amount of time that passes before the monitor turns off to save power. The default setting is 1 min.</p>	 72
Format memory/ Format card	<p>Allows you to format the internal memory (only when a memory card is not inserted) or the memory card (when a memory card is inserted).</p> <ul style="list-style-type: none"> All data stored in the internal memory or on the memory card is deleted during formatting and cannot be restored. Be sure to save important images by transferring them to a computer before formatting. 	 73
Language	<p>Allows you to change the camera's display language.</p>	 74
TV settings	<p>Set these settings to match your TV. You can select the video output mode (NTSC or PAL) and adjust HDMI output settings.</p>	 74

The Setup Menu

Option	Description	
Charge by computer	<p>When set to Auto (default setting), you can charge the camera's battery by connecting the camera to a computer (provided that the computer is able to supply power).</p> <ul style="list-style-type: none"> When charging by computer, it takes more time to charge the battery than when using the Charging AC Adapter EH-69P. Additionally, when charging by computer and transferring images to the computer, it takes more time to charge the battery. 	 75
Blink warning	<p>Except when using continuous shooting mode or smile timer, the camera will display the message Did someone blink? immediately after taking a picture using face detection ( 76) if the camera detects a subject with closed eyes, allowing you to check the image. The default setting is Off.</p>	 77
Filmstrip	<p>When On is selected, thumbnails of previous and subsequent images are displayed in the bottom of the monitor when you rotate the multi selector quickly while viewing an image in full-frame playback mode ( 30). The default setting is Off.</p>	 79
Reset all	<p>Allows you to reset the camera's settings to their default values.</p> <ul style="list-style-type: none"> Certain settings such as Time zone and date and Language are not reset. 	 80
Firmware version	View the current camera firmware version.	 83



Reference Section

The Reference Section provides detailed information and hints about using the camera.

Shooting

Using Easy Panorama (Shooting and Playback)	02
Using Panorama Assist	05

Playback

Playing Back and Deleting Images Captured Continuously (Sequence)	07
Editing Still Images	10
Connecting the Camera to a TV (Viewing Images on a TV)	21
Connecting the Camera to a Printer (Direct Print)	23

Menus

The Shooting Menu (for (Auto) Mode, Continuous Shooting Mode)....	30
The Playback Menu	43
The Movie Menu	55
The Setup Menu	60

Additional Information

File and Folder Names	84
Optional Accessories	85
Error Messages	86

Using Easy Panorama (Shooting and Playback)

Shooting With Easy Panorama

- 1 Rotate the mode dial to **SCENE**, press the **MENU** button and select **Panorama** (📖 39).

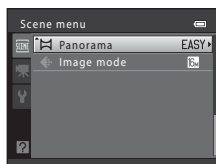
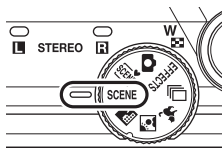

- 2 Select **EASY Easy panorama** and press the **OK** button.

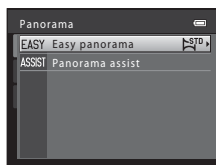

- 3 Select **STD Normal (180°)** or **WIDE Wide (360°)** as the shooting range and press the **OK** button.

- When the camera is readied in the horizontal position, the image size (width × height) is as follows.
 - STD Normal (180°)**:
 - 3200 × 560 when moved horizontally
 - 1024 × 3200 when moved vertically
 - WIDE Wide (360°)**:
 - 6400 × 560 when moved horizontally
 - 1024 × 6400 when moved vertically
- When the camera is readied in the vertical position, the direction and the width and height are switched.

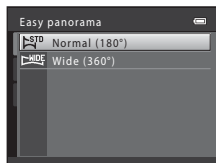

- 4 Frame the first edge of the panorama scene, and then press the shutter-release button halfway to focus.

- The zoom position is fixed at the maximum wide-angle position.
- A grid is displayed in the monitor.
- The camera focuses on the subject in the center of the frame.
- Exposure compensation (📖 65) can be set.
- If the focus and exposure are not correct, try using focus lock (📖 78).

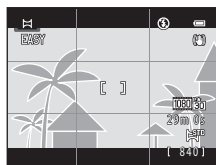

- 5** Press the shutter-release button all the way, and then remove your finger from the shutter-release button.

- ▷ is displayed to indicate the direction of camera movement.



- 6** Move the camera slowly and straight in one of the four directions, and begin shooting.

- When the camera detects which direction it is moving in, shooting begins.
- A guide indicating the current shooting position is displayed.
- When the shooting position guide reaches the edge, shooting ends.



Shooting position guide

Example of camera movement

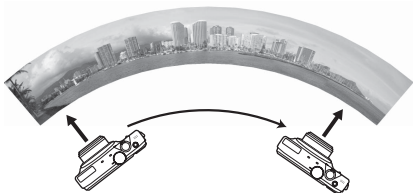

- The operator, without shifting position, moves the camera horizontally or vertically in an arc from one edge of the guide to the other.
- Shooting ends if the edge of the guide is not reached within about 15 seconds (when using **STD Normal (180°)**) or within about 30 seconds (when using **WIDE Wide (360°)**).

Notes About Easy Panorama Shooting

- The range of the image seen in the saved image will be narrower than that seen in the monitor at the time of shooting.
- If the camera is moved too quickly, if the camera is shaken too much, or if the subject has little variance in appearance (such as a wall or in darkness), an error will occur.
- If shooting is stopped before the camera reaches the half-way point in the panorama range, a panorama image is not saved.
- If more than half of the panorama range is captured but shooting ends before reaching the edge of the range, the range not captured is recorded and displayed in gray.

Playing Back Images With Easy Panorama (Scroll Playback)

Switch to playback mode (📖 30), display an image captured using easy panorama in full-frame playback mode, and then press the **OK** button to display the short edge of the image using the entire monitor and automatically move (scroll) the displayed area.

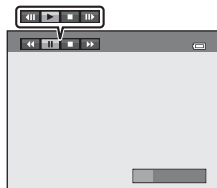
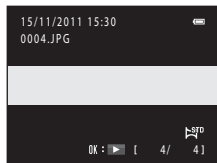

- The image scrolls in the direction that the camera was moved at the time of shooting.
 - Rotate the multi selector to advance or rewind.
- Playback controls are displayed at the top of the monitor during playback. Press the multi selector ◀ or ▶ to select a control, and then press the **OK** button to use the following operations.

Function	Icon	Description	
Rewind	◀◀	Hold down the OK button to scroll backward quickly.	
Advance	▶▶	Hold down the OK button to scroll forward quickly.	
Pause	⏸	The following operations can be performed while playback is paused using the controls displayed at the top in the monitor	
		◀◀	Hold down the OK button to rewind.*
		▶▶	Hold down the OK button to scroll.*
	▶	Resume automatic scrolling.	
End	■	Switch to full-frame playback mode.	

* Scrolling can also be performed by rotating the multi selector.

✓ Notes About Images Captured With Easy Panorama

The histogram and shooting information are not displayed for images captured with easy panorama (📖 8).

✓ Notes About Easy Panorama Scroll Playback

The camera may not be able to scroll the playback of, or zoom in on, easy panorama images captured with another make or model of digital camera.

Using Panorama Assist

Use a tripod for the best results. Set **Vibration reduction** (📷67) to **Off** in the setup menu when using a tripod to stabilize the camera.

- 1 Rotate the mode dial to **SCENE**, press the **MENU** button and select **Panorama** (📖 39).

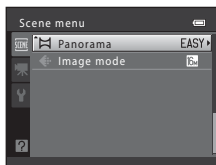
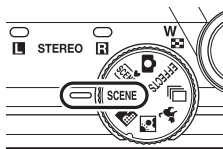

- 2 Select **ASSIST Panorama assist** and press the **OK** button.

- Panorama direction icons are displayed to show the direction in which images will be joined.

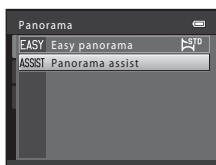

- 3 Use the multi selector to select the direction and press the **OK** button.

- Select the direction in which images will be joined in the completed panorama; right (➡), left (⬅), up (⬆), or down (⬇).
- The yellow panorama direction icon (➡) is displayed for the current direction and the direction is fixed when the **OK** button is pressed. The icon changes to the white fixed direction ➡ icon.
- If necessary, apply flash mode (📖 56), self-timer (📖 59), macro mode (📖 64), and exposure compensation (📖 65) settings with this step.
- Press the **OK** button again to select a different direction.

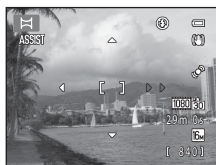

- 4 Frame the first portion of the panorama scene and take the first picture.

- The camera focuses on the subject in the center of the frame.
- One third of the image will be displayed as translucent.



5 Take the next picture.

- Frame the next image so that one third of the frame overlaps the first image, and press the shutter-release button.
- Repeat this process until the necessary number of images has been taken to complete the scene.



6 Press the **OK** button when shooting is complete.

- The camera returns to step 3.

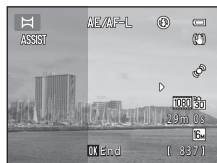

✓ Notes About Panorama Assist

- Set flash mode, self-timer, macro mode and exposure compensation before taking the first picture. They cannot be changed after the first picture is taken. Images cannot be deleted, nor can zoom or **Image mode** setting (71) be adjusted after the first picture is taken.
- Shooting ends if the auto off function (72) is activated. If the camera enters standby mode during shooting, set **Auto off** to a longer setting.

✎ AE/AF-L Indicator

In panorama assist mode, exposure, white balance, and focus for all images in a panorama are fixed at the values for the first image in each series.

When the first picture is taken, **AE/AF-L** is displayed to indicate that exposure, white balance, and focus are locked.



✎ Combining Images to Make a Panorama

Transfer images to a computer (84) and use Panorama Maker 5 to join them in a single panorama.

Install Panorama Maker 5 from the included ViewNX 2 Installer CD-ROM.

- After installing Panorama Maker 5, start the software as explained below.
 - Windows: Select the **Start** menu > **All Programs** > **ArcSoft Panorama Maker 5** > **Panorama Maker 5**
 - Mac OS X: Open the **Applications** folder > double-click **Panorama Maker 5**
- For information about using Panorama Maker 5, refer to the on-screen instructions and help information contained in Panorama Maker 5.

✎ More Information

See "File and Folder Names" (84) for more information.

Playing Back and Deleting Images Captured Continuously (Sequence)

Each series of images captured using the following settings is saved in a sequence.

- Continuous shooting mode (📖 50)
 - Continuous
 - Pre-shooting cache
 - Continuous H: 120 fps
 - Continuous H: 60 fps
 - Smile timer continuous
- Scene mode (📖 40)
 - Sports
 - Pet portrait mode (when **Continuous** is selected)

Playing Back Sequences

In full-frame playback mode or thumbnail playback mode (📖 31), the first image of a sequence is used as the “key picture,” i.e., it is displayed to represent the images in the sequence.

While the key picture of a sequence is displayed in full-frame playback mode, press the **OK** button to display each image in the sequence individually. To return to key picture only display, press the multi selector **▲**.

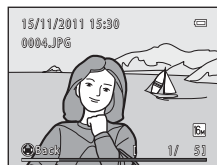
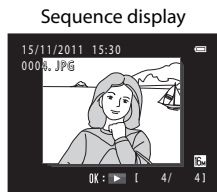

The following operations are available when each image in a sequence is displayed individually.

- Select an image: Rotate the multi selector or press **◀** or **▶**.
- Zoom in: Rotate the zoom control to **T** (📖 31).
- Display the histogram and shooting information: Press the **OK** button.

✓ Notes About Sequence

The camera cannot display images that were captured continuously as a sequence if the images were captured with another make or model of digital camera.

✓ Notes About Images Captured in a Sequence

The histogram and shooting information are not displayed when only a sequence's key picture is displayed (📖 8).

How Sequences Are Displayed on the Playback Screen

When using thumbnail playback mode, images are displayed as shown below.

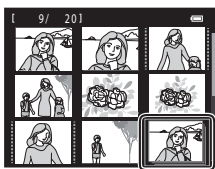

4/9/16-image thumbnails

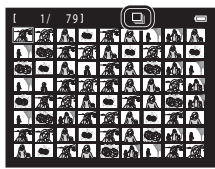

72-image thumbnails

When **Sequence display options** (54) in the playback menu is set to **Individual pictures**, if you select images in a sequence when using full-frame playback mode or thumbnail playback mode, the  icon is displayed.

Sequence Display Options

Select **Sequence display options** (54) in the playback menu to set all sequences to be displayed using their key pictures only or to display them as individual images.

Changing Key Picture of a Sequence

A sequence's key picture can be changed using **Choose key picture** (54) in the playback menu.

Functions Available When Playing Back Sequences

The following menu operations are available by pressing the **MENU** button when playing back images captured in a sequence:

- Quick retouch¹ (12)
- Skin softening¹ (14)
- Print order² (43)
- Protect² (47)
- Small picture¹ (18)
- Copy² (52)
- Choose key picture (54)
- D-Lighting¹ (13)
- Filter effects¹ (16)
- Slide show (46)
- Rotate image¹ (49)
- Voice memo¹ (50)
- Sequence display options (54)

¹ Press the **MENU** button after displaying individual images. Settings can be applied to individual images.

² If you press the **MENU** button while playing back only the key picture of a sequence, the same settings can be applied to all images in that sequence. Press the **MENU** button after displaying individual images to apply settings to individual images.

Deleting Images in a Sequence

If **Sequence display options** (🔍 54) in the playback menu is set to **Key picture only**, press the 🗑️ button to select a deletion method and delete the following images.

- If only the key picture is displayed to represent all images:
 - **Current image:** When a sequence is selected, all images in that sequence are deleted.
 - **Erase selected images:** When the key picture is selected in the deletion image selection screen (📖 33), all images in the sequence are deleted.
 - **All images:** All images are deleted, including the currently displayed sequence.
- If the key picture is selected and the Ⓞ button is pressed to display each individual image in the sequence before pressing the 🗑️ button:
Deletion methods change as follows.
 - **Erase current picture:** The image currently displayed is deleted.
 - **Erase selected images:** When multiple images in the same sequence are selected in the deletion image selection screen (📖 33), the selected images are deleted.
 - **Erase entire sequence:** All images in the sequence, including the image currently displayed, are deleted.

Editing Still Images

Editing Features

Use the COOLPIX S8200 to edit images in-camera and save them as separate files (📷84). The editing functions described below are available.

Editing function	Description
Quick retouch (📷12)	Easily create retouched copies in which contrast and saturation have been enhanced.
D-Lighting (📷13)	Create a copy of the current image with enhanced brightness and contrast, brightening dark portions of the image.
Skin softening (📷14)	Make facial skin tones softer.
Filter effects (📷16)	Digital filter effects can be used to apply a variety of effects to images. Effect types include Cross screen , Fisheye , Miniature effect , and Painting .
Small picture (📷18)	Create a small copy of images suitable for use as e-mail attachments.
Crop (📷19)	Crop a portion of the image. Use to zoom in on a subject or arrange a composition.

✓ Notes About Image Editing

- Images captured at an **Image mode** setting of 📷 4608x2592 (📖 71) cannot be edited.
- Images captured using easy panorama (📖 49, 📷2) cannot be edited.
- The editing functions of the COOLPIX S8200 cannot be used for images captured with another make or model of digital cameras.
- If no face is detected in an image, a copy cannot be created using the skin softening function (📷14).
- Edited copies created with the COOLPIX S8200 may not be displayed properly on another make or model of digital camera. It may also be impossible to transfer them to a computer using another make or model of digital camera.
- Editing functions are not available when there is not enough free space in the internal memory or on the memory card.
- For sequences for which only a key picture is displayed (📷7), perform one of the following operations before editing.
 - Press **OK** button to display individual images, and then select an image in the sequence
 - Set **Sequence display options** (📷54) to **Individual pictures** so that each image is displayed individually, and then select an image

Restrictions on Image Editing

When an edited copy is further modified with another editing function, check the following restrictions.

Editing function used	Editing functions that can be added
Quick retouch D-Lighting	The skin softening, filter effects, small picture, or crop function can be added. The quick retouch and D-Lighting functions cannot be used together.
Skin softening Filter effects	The quick retouch, D-Lighting, small picture, or crop function can be added. Additionally, the skin softening and filter effects functions can be used together.
Small picture Crop	Another editing function cannot be added.



- Copies created with editing functions cannot be further edited with the same function used to create them.
- When combining the small picture or crop function and another editing function, use the small picture and crop functions after other editing functions have been applied.
- Skin softening can also be applied to images captured with the skin softening function (📖 77).

Original and Edited Images

- Copies created with editing functions are not deleted if the original images are deleted. The original images are not deleted if copies created with editing functions are deleted.
- Edited copies are saved with the same shooting date and time as the original.
- Print order (🔍 43) and protect settings (🔍 47) do not remain effective in edited copies.

Quick Retouch: Enhancing Contrast and Saturation



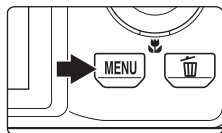

Quick retouch can be used to easily create retouched copies in which contrast and saturation have been enhanced. Copies created with the quick retouch function are saved as separate files.

- 1 Select an image in full-frame playback mode ( 30) or thumbnail playback mode ( 31) and press the **MENU** button.

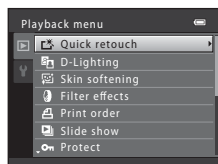

- 2 Use the multi selector to select  **Quick retouch** and press the **OK** button.
 - The original version is displayed on the left and the edited version is displayed on the right.



- 3 Press the multi selector  or  to select the degree of enhancement performed and press the **OK** button.
 - A new, edited copy is created.
 - To exit without saving the copy, press the multi selector .
 - Copies created with the quick retouch function are indicated by the  icon displayed during playback.

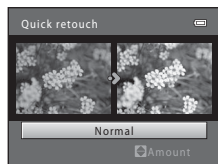



More Information

See "File and Folder Names" ( 84) for more information.

D-Lighting: Enhancing Brightness and Contrast

D-Lighting can be used to create copies with enhanced brightness and contrast, brightening dark portions of an image. Enhanced copies are saved as separate files.

- 1 Select an image in full-frame playback mode ( 30) or thumbnail playback mode ( 31) and press the **MENU** button.

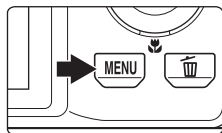

- 2 Use the multi selector to select  **D-Lighting** and press the **OK** button.

- The original version is displayed on the left and the edited version is displayed on the right.

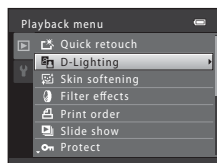

- 3 Select **OK** and press the **OK** button.

- A new, edited copy is created.
- To exit without saving the copy, select **Cancel** and press the **OK** button.
- Copies created with the D-Lighting function are indicated by the  icon displayed during playback.

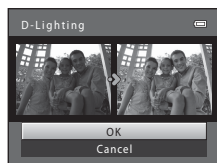



More Information

See "File and Folder Names" ( 84) for more information.

Skin Softening: Softening Skin Tones

The camera detects faces in images and creates a copy with softer facial skin tones. Copies created using the skin softening function are saved as separate files.

- 1 Select an image in full-frame playback mode ( 30) or thumbnail playback mode ( 31) and press the **MENU** button.

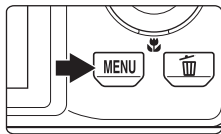

- 2 Use the multi selector to select  **Skin softening** and press the **OK** button.

- The screen for selecting the degree of softening is displayed.
- If no faces are detected in the image, an alert is displayed and the camera returns to the playback menu.

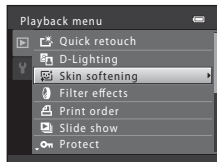

- 3 Press the multi selector **▲** or **▼** to select the degree of softening and press the **OK** button.

- The confirmation dialog is displayed with the face to which skin softening was applied enlarged in the center of the monitor.
- To exit without saving the copy, press the multi selector **◀**.

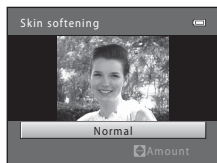

- 4 Check the preview of the copy.

- Skin tones in up to 12 faces, in the order of that closest to the center of the frame, are softened.
- If more than one face was softened, press the multi selector **◀** or **▶** to display a different face.
- Press the **MENU** button to adjust the degree of softening. The monitor display returns to that shown in step 3.
- When the **OK** button is pressed, a new, edited copy is created.
- Copies created with the skin softening function are indicated by the  icon displayed during playback.

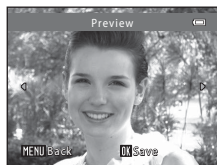

 Notes About Skin Softening

Depending upon the direction in which faces are looking, or the brightness of faces, the camera may be unable to accurately recognize faces, or the skin softening function may not perform as expected.



 More Information

See "File and Folder Names" (84) for more information.

Filter Effects: Applying Digital Filter Effects

Digital filter effects can be used to apply a variety of effects to images. The following effects are available. Copies created with the filter effects function are saved as separate files.

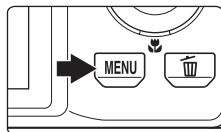

Type	Description
Cross screen	Produce star-like rays of light that radiate outward from bright objects such as sunlight reflections or street lights. This effect is suitable for night scenes.
Fisheye	Make an image look as if it were captured with a fisheye lens. This effect is well-suited for images captured in macro mode.
Miniature effect	Make an image look like a miniature scene captured in macro mode. This effect is well-suited for images captured from a high vantage point with the main subject in the center of the image.
Painting	Gives images a hand-painted appearance.

- 1 Select an image in full-frame playback mode ( 30) or thumbnail playback mode ( 31) and press the **MENU** button.

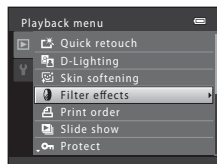

- 2 Use the multi selector to select  **Filter effects** and press the **OK** button.



- 3 Press the multi selector  or  to select an effect, and press the **OK** button.

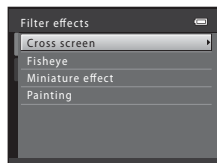

4 Confirm the effect, and press the **OK** button.

- A new, edited copy is created.
- To exit without saving the copy, press the multi selector **◀**.

- Copies created using the filter effects function are indicated by the **Ⓢ** icon displayed during playback.

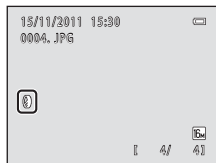
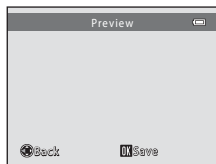



More Information

See "File and Folder Names" ( 84) for more information.

Small Picture: Reducing the Size of an Image

Create a small copy of the current image. This feature is useful for creating copies for display on Web pages or for e-mail attachments. The **640×480**, **320×240**, and **160×120** sizes are available. Small copies are saved as separate files with a compression ratio of about 1:16.

- 1 Select an image in full-frame playback mode ( 30) or thumbnail playback mode ( 31) and press the **MENU** button.

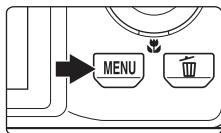

- 2 Use the multi selector to select  **Small picture** and press the **OK** button.

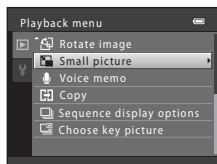

- 3 Select the desired copy size and press the **OK** button.

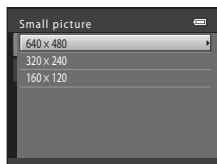



- 4 Select **Yes** and press the **OK** button.
 - A new, small copy is created.
 - To exit without saving the copy, select **No** and press the **OK** button.
 - The copy is displayed with a black frame.



More Information

See "File and Folder Names" ( 84) for more information.

Crop: Creating a Cropped Copy

Create a copy containing only the portion visible in the monitor when **MENU**  is displayed with playback zoom ( 31) enabled. Cropped copies are saved as separate files.



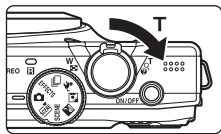

1 Rotate the zoom control to **T** (Q) in full-frame playback mode (30) to zoom in on the image.

- To crop an image displayed in “tall” (portrait) orientation, zoom in on the image until the black bars displayed on the both sides of the monitor disappear.



The cropped image will be displayed in landscape orientation. To crop the image in its current “tall” (portrait) orientation, first use the **Rotate image** option ( 49) to rotate the image so that it is displayed in landscape orientation. Next, enlarge the image for cropping, crop the image, and then rotate the cropped image back to “tall” (portrait) orientation.

2 Refine copy composition.

- Rotate the zoom control to **T** (Q) or **W** () to adjust the zoom ratio.
- Press the multi selector , , , or  to scroll the image so that only the portion to be copied is visible in the monitor.



3 Press the **MENU** button.

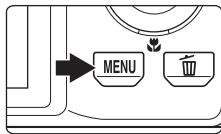

4 Use the multi selector to select **Yes** and press the **OK** button.

- A cropped copy is created.
- To exit without saving the copy, select **No** and press the **OK** button.



Editing Still Images

Image Size

As the area to be saved is reduced, the image size (pixels) of the cropped copy is also reduced. When the image size of the cropped copy is 320×240 or 160×120 , a black frame is displayed around the image, and the small picture icon  is displayed in the left of the monitor in playback mode.

More Information

See “File and Folder Names” ( 84) for more information.

Connecting the Camera to a TV (Viewing Images on a TV)

Connect the camera to a TV to play images or movies back on the TV. If your TV is equipped with an HDMI jack, a commercially available HDMI cable can be used to connect the camera to the TV.

- 1 Turn off the camera.

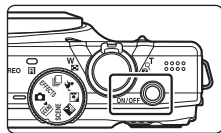

- 2 Connect the camera to the TV.

When using the included audio/video cable

Connect the yellow plug to the video-in jack and the white and red plugs to the audio-in jacks on the TV.

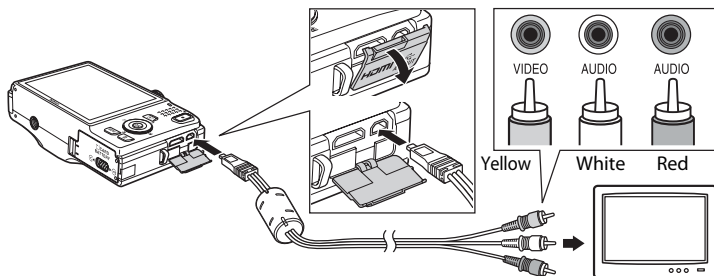

When using a commercially available HDMI cable

Connect the plug to the HDMI jack on the TV.

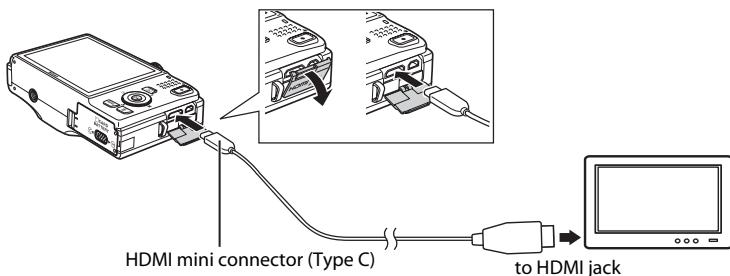

3 Set the TV's input to external video input.



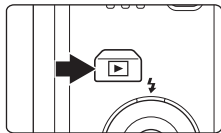

- See the documentation provided with your TV for details.

4 Press and hold the camera's button and turn on the camera.

- The camera enters playback mode and images are displayed on the TV.
- While connected to the TV, the camera monitor will remain off.



Notes About Connecting the HDMI Cable

- HDMI cable is not included. Use a commercially available HDMI cable to connect the camera to a TV. The output terminal on this camera is an HDMI mini connector (type C). When purchasing an HDMI cable, be sure that the device end of the cable is an HDMI mini connector.
- We recommend shooting still images at an **Image mode** ( 71) setting of  **2048x1536** or higher, and movies at a **Movie options** ( 55) setting of  **HD 720p (1280x720)** or higher.

Notes About Connecting the Cable

- When connecting the cable, be sure that the camera plug is properly oriented. Do not use force when connecting the cable to the camera. When disconnecting the cable, do not pull the plug at an angle.
- Do not connect cables to the HDMI mini connector (Type C) and to the USB/audio/video output connector simultaneously.

If the Images Are Not Displayed on the TV

Be sure that the camera's video mode setting of **TV settings** ( 74) in the setup menu conforms to the standard used by your TV.

Using a TV Remote Control (HDMI Device Control)

The remote control of an HDMI-CEC-compatible TV can be used to control playback.

It can be used instead of the camera's multi selector and zoom control to select images, start and pause movie playback, scroll playback of images captured using easy panorama, and switch between full-screen playback mode and 4-image thumbnail display.

- Set the **HDMI device control** setting ( 74) of **TV settings** to **On** (default setting) and then connect the camera and TV using an HDMI cable.
- Aim the remote control at the TV when operating it.
- Refer to the TV's operating instructions for information about the TV's HDMI-CEC compatibility.

Connecting the Camera to a Printer (Direct Print)

Users of PictBridge-compatible (🔦19) printers can connect the camera directly to the printer and print images without using a computer.

Follow the procedures below to print images.

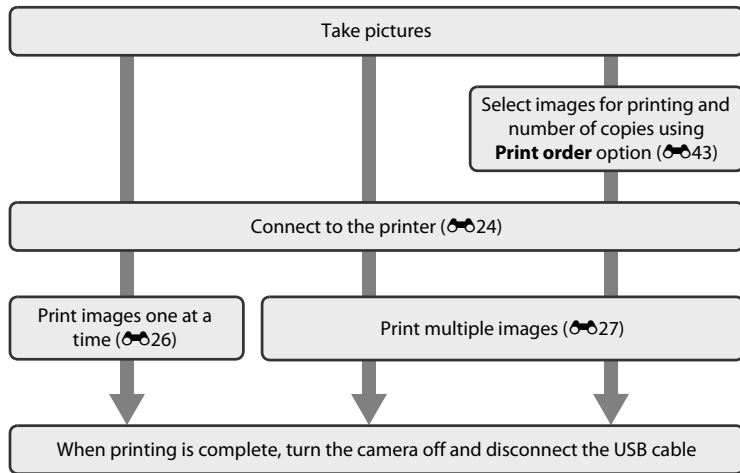

✔ Notes About Power Source

- When connecting the camera to a printer, use a fully charged battery to prevent the camera from turning off unexpectedly.
- If the AC Adapter EH-62F (available separately) is used, COOLPIX S8200 can be powered from an electrical outlet. Do not use any other make or model of AC adapter as it may cause the camera to heat up or malfunction.

📎 Printing Images

In addition to printing images transferred to a computer from your personal printer and printing over a direct camera-to-printer connection, the following options are also available for printing images saved on the memory card:

- Inserting a memory card into a DPOF-compatible printer's card slot
- Taking a memory card to a digital photo lab

For printing using these methods, specify the images and the number of prints each to the memory card using the **Print order** option in the playback menu (🔦43).

Connecting the Camera to a Printer

- 1 Turn off the camera.

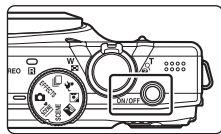

- 2 Turn on the printer.

- Check printer settings.

- 3 Connect the camera to the printer using the included USB cable.

- Be sure that plugs are properly oriented. Do not attempt to insert plugs at an angle, and do not use force when connecting or disconnecting the USB cable.

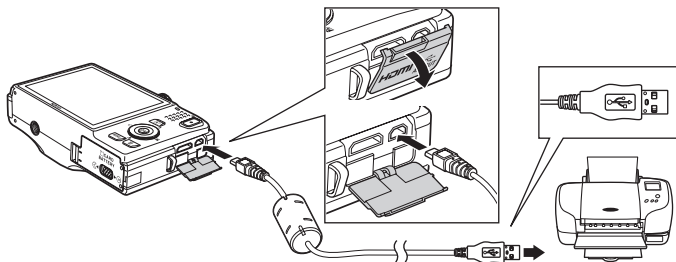

4 The camera is automatically turned on.

- When properly connected, the **PictBridge** startup screen (①) will be displayed in the camera monitor, followed by the **Print selection** screen (②).

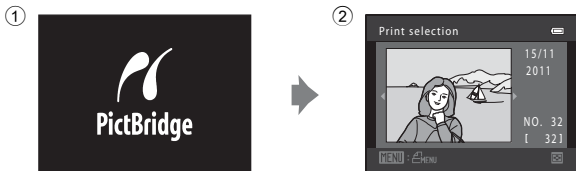
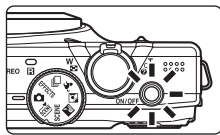

✔ If the PictBridge Startup Screen Is Not Displayed

Turn the camera off and disconnect the USB cable. Set the **Charge by computer** option (0075) in the camera's setup menu to **Off** and reconnect the cable.

Printing Individual Images

After properly connecting the camera to the printer (📷24), follow the procedures described below to print an image.

1 Use the multi selector to select the desired image and press the **OK** button.

- Rotate the zoom control to **W** (📷) to display 12 thumbnails, and **T** (📺) to switch back to full-frame playback.

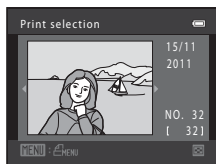

2 Select **Copies** and press the **OK** button.

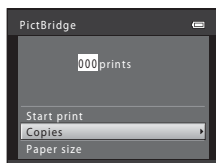

3 Select the desired number of copies (up to nine) and press the **OK** button.

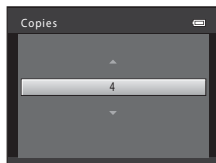

4 Select **Paper size** and press the **OK** button.

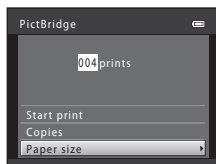

5 Select the desired paper size and press the **OK** button.

- To specify paper size using settings on the printer, select **Default** in the paper size option.

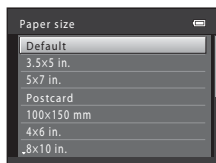

- 6** Select **Start print** and press the **OK** button.

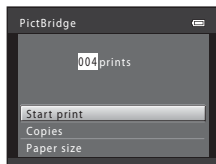

- 7** Printing begins.

- Monitor display returns to the screen shown in step 1 when printing is complete.
- To cancel printing before all copies have been printed, press the **OK** button.

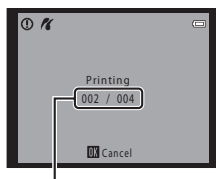

Current number of copies/
total number of copies

Printing Multiple Images

After properly connecting the camera to the printer (24), follow the procedures described below to print multiple images.

- 1** When the **Print selection** screen is displayed, press the **MENU** button.
- The **Print menu** screen is displayed.

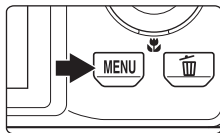

- 2** Use the multi selector to select **Paper size** and press the **OK** button.
- To exit the print menu, press the **MENU** button.

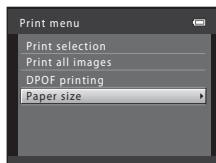

- 3** Select the desired paper size and press the **OK** button.
- To specify paper size using settings on the printer, select **Default** in the paper size option.

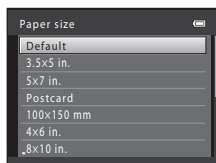

- 4** Select **Print selection**, **Print all images**, or **DPOF printing** and press the **OK** button.

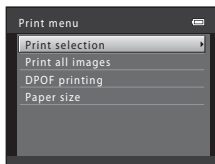

Print selection

Select images (up to 99) and the number of copies (up to nine) of each.

- Rotate the multi selector, or press ◀ or ▶ to select images, and press ▲ or ▼ to specify the number of copies to be printed.
- Images selected for printing are indicated by the check mark (✓) and the numeral indicating the number of copies to be printed. If no copies have been specified for images, the selection is canceled.
- Rotate the zoom control to **T** (Q) to switch back to full-frame playback or **W** (E) to display 12 thumbnails.
- Press the **OK** button when setting is complete.
- When the screen shown on the right is displayed, select **Start print** and press the **OK** button to start printing. Select **Cancel** and press the **OK** button to return to the print menu.

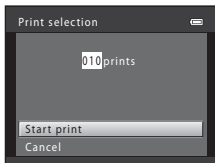

Print all images

One copy each of all images saved in the internal memory, or on the memory card, is printed.

- When the screen shown on the right is displayed, select **Start print** and press the **OK** button to start print. Select **Cancel** and press the **OK** button to return to the print menu.

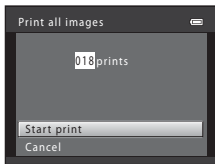

DPOF printing

Print images for which a print order was created using the **Print order** option (43).

- When the screen shown on the right is displayed, select **Start print** and press the **OK** button to start printing. Select **Cancel** and press the **OK** button to return to the print menu.
- To view the current print order, select **View images** and press the **OK** button. To print images, press the **OK** button again.

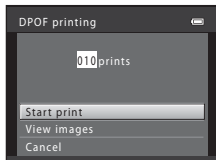

5 Printing begins.

- Monitor display returns to the screen shown in step 2 when printing is complete.
- To cancel printing before all copies have been printed, press the **OK** button.

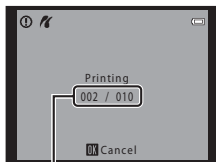



Current number of copies/
total number of copies



Paper Size

The camera supports the following paper sizes: **Default** (the default paper size for the printer connected to the camera), **3.5×5 in.**, **5×7 in.**, **100×150 mm**, **4×6 in.**, **8×10 in.**, **Letter**, **A3**, and **A4**. Only sizes supported by the printer will be displayed.

The Shooting Menu (for (Auto) Mode, Continuous Shooting Mode)







- See “Changing the Image Size (Image Mode)” ( 71) for information about **Image mode**.
- Other than the **Continuous** ( 35), items share the same settings with  (auto) mode and continuous shooting mode, and the settings are saved in the camera’s memory even if the camera is turned off.
- **Continuous** can be selected only when using continuous shooting mode.

White Balance (Adjusting Hue)

Enter  (auto) mode or continuous shooting mode → MENU button →  or  tab → White balance





The color of light reflected from an object varies with the color of the light source. The human brain is able to adapt to changes in the color of the light source, with the result that white objects appear white whether seen in the shade, direct sunlight, or under incandescent lighting. Digital cameras can mimic this adjustment by processing images according to the color of the light source. This is known as “white balance.” For natural colors, select a white balance setting that matches the light source before shooting.

Although the default setting, **Auto**, can be used under most types of lighting, the white balance setting suited to a particular light source can be specified manually to achieve more accurate results.

Option	Description
AUTO Auto (default setting)	White balance is automatically adjusted to suit lighting conditions. Best choice in most situations.
PRE Preset manual	Useful when shooting under unusual lighting. See “Using Preset Manual” for more information ( 32).
 Daylight	White balance adjusted for direct sunlight.
 Incandescent	Use under incandescent lighting.
 Fluorescent	Use under fluorescent lighting.
 Cloudy	Use when taking pictures under overcast skies.
 Flash	Use with the flash.

The current white balance setting is indicated by an icon when shooting ( 6). No icon is displayed when **Auto** is selected.

Notes About White Balance

- When hue is adjusted using the creative slider ( 67), this feature cannot be set.
- Some settings cannot be used with other functions ( 73).
- At white-balance settings other than **Auto** or **Flash**, turn the flash off (  56).

Using Preset Manual

Preset manual is used with mixed lighting or to compensate for light sources with a strong color cast when the desired effect has not been achieved with white balance settings like **Auto** and **Incandescent** (for example, to make images shot under a lamp with a red shade look as though they had been shot under white light).

Use the procedure below to measure the white balance value under the lighting used during shooting.

1 Place a white or gray reference object under the lighting that will be used during shooting.

2 Display the shooting menu (, 11, 37), use the multi selector to select **PRE Preset manual** in the **White balance** menu, and press the **OK** button.

- The camera zooms in to the position for measuring white balance.

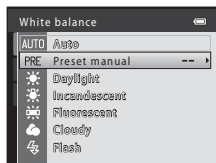

3 Select **Measure**.

- To apply the most recently measured white balance value, select **Cancel** and press the **OK** button. The white balance setting will not be measured again and the most recently measured value will be set.

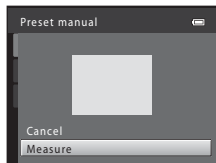

4 Frame the reference object in the measuring window.

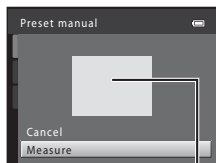

Measuring window



5 Press the **OK** button to measure a value for preset manual.

- The shutter is released and the new white-balance value is set. No image is saved.

Notes About Preset Manual



A value for flash lighting cannot be measured with **Preset manual**. When shooting using the flash, set **White balance** to **Auto** or **Flash**.

Metering

Enter  (auto) mode or continuous shooting mode → MENU button →  or  tab → Metering

The process of measuring the brightness of the subject to determine exposure is known as metering.

Select how the camera meters exposure.

Option	Description
 Matrix (default setting)	Uses a wide area of the screen for metering. This metering mode provides the appropriate exposure for a variety of shooting conditions. Recommended in most situations.
 Center-weighted	The camera meters the entire frame but assigns greatest weight to the subject in the center of the frame. Classic meter for portraits; preserves background details while letting lighting conditions in the center of the frame determine exposure. Can be used with focus lock ( 78) to meter off-center subjects.

Notes About Metering



While digital zoom is in effect, metering is set to center-weighted metering. The active metering area is not displayed.

Metering Area

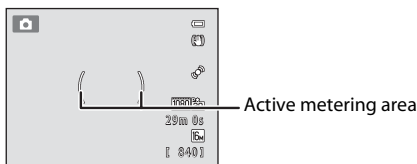
The active metering area is displayed in the monitor when **Center-weighted** is selected for **Metering**.



ISO Sensitivity

Enter  (auto) mode or continuous shooting mode → MENU button →  or  tab → ISO sensitivity



When ISO sensitivity is increased, less light is needed when taking pictures.

Higher ISO sensitivity allows darker subjects to be captured. Additionally, even with subjects of similar brightness, pictures can be taken at faster shutter speeds, and blurring caused by camera shake and subject movement can be reduced.



- Although higher ISO sensitivity is effective when shooting darker subjects, when shooting without the flash, when shooting with the camera zoomed in, etc., images may contain noise.

Option	Description
Auto (default setting)	Sensitivity is ISO 100 when there is sufficient lighting; the camera compensates by raising sensitivity to a maximum of ISO 1600 when lighting is dim.
Fixed range auto	Select the range in which the camera automatically adjusts ISO sensitivity; ISO 100-400 and ISO 100-800 are available. The camera will not increase sensitivity beyond the maximum value in the selected range. Set the maximum value for ISO sensitivity for effective control over the amount of grain that appears in images.
100, 200, 400, 800, 1600, 3200	ISO sensitivity is locked at the specified value.

The current ISO sensitivity setting is indicated by an icon when shooting ( 6).

- When **Auto** is selected, the  icon is not displayed at ISO 100, but is displayed if the ISO sensitivity automatically increases to more than 100.
- When **Fixed range auto** is selected,  and the maximum value for ISO sensitivity are displayed.







Notes About ISO Sensitivity



- Some settings cannot be used with other functions ( 73).
- When ISO sensitivity is fixed, **Motion detection** ( 68) is disabled.

Continuous Shooting

Enter shooting mode → MENU button →  tab → Continuous

Select the desired continuous shooting option (only when using continuous shooting mode).

Option	Description
 Continuous (default setting)	While the shutter-release button is held all the way down, images are captured continuously at a rate of about 6 fps (when image mode is set to  4608×3456). Shooting ends when the shutter-release button is released, or 5 images have been captured.
 Pre-shooting cache	Pre-shooting cache makes it easy to capture perfect moments, by saving images from before the shutter-release button was pressed all the way. Pre-shooting cache shooting begins when the shutter-release button is pressed halfway, and shooting continues when the shutter-release button is pressed all the way ( 36). <ul style="list-style-type: none"> • Frame rate: up to 15 fps • Number of frames: Up to 20 frames (including up to 5 frames captured in the pre-shooting cache) Shooting ends when the shutter-release button is released or when the maximum number of frames has been shot. Image mode is fixed at  3M.
120 Continuous H: 120 fps	Each time the shutter-release button is pressed all the way, 60 frames are captured at a speed of about 1/125 s or faster. Image mode is fixed at  VGA.
60 Continuous H: 60 fps	Each time the shutter-release button is pressed all the way, 60 frames are captured at a speed of about 1/60 s or faster. Image mode is fixed at  1M (image size: 1280 × 960 pixels).
BSS BSS (best shot selector)	The “best shot selector” is recommended when shooting with the flash off or the camera zoomed in, or in other situations in which inadvertent motion can result in blurred images. The camera captures a series of up to 10 images while the shutter-release button is held all the way down, and the sharpest image in the series is automatically selected and saved. <ul style="list-style-type: none"> • Best suited to shooting subjects that are not moving. When shooting moving subjects or when the composition of the picture changes while shooting, the desired results may not be achieved.

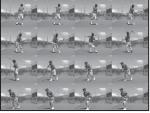
Option	Description
 Multi-shot 16	Each time the shutter-release button is pressed, the camera takes 16 shots at a rate of about 30 fps and arranges them in a single image. <ul style="list-style-type: none"> Image mode is fixed at  (image size: 2560 × 1920 pixels). Digital zoom cannot be used. 

The current continuous shooting setting is indicated by an icon when shooting ( 6).

Pre-shooting Cache

When **Pre-shooting cache** is selected, shooting begins when the shutter-release button is pressed halfway for 0.5 seconds or longer, and images captured before the shutter-release button is pressed all the way are saved along with images captured after the shutter-release button is pressed all the way. Up to 5 images can be saved in the pre-shooting cache.

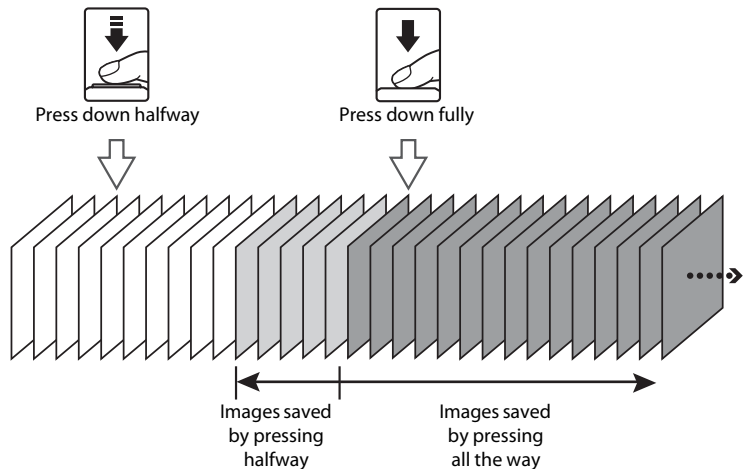

The current pre-shooting cache setting is indicated by an icon when shooting ( 6). No icon is displayed when the pre-shooting cache is not set. The pre-shooting cache icon lights in green while the shutter-release button is pressed halfway.

Reference Section





- If the number of exposures remaining is less than 6, shooting with the pre-shooting cache is not possible. Before shooting, check that there are 6 or more exposures remaining.

AF Area Mode

Enter  (auto) mode or continuous shooting mode → MENU button →  or  tab → AF area mode

Use this option to determine how the camera selects the focus area for autofocus.

Option	Description
 Face priority	<p>When the camera detects a human face, it focuses on that face. See “Using Face Detection” ( 76) for more information. If more than one face is detected, the camera focuses on the face closest to the camera.</p> <p>When taking pictures of subjects other than people, or framing a subject with which no face is detected, the AF area mode setting switches to Auto, and the camera will automatically select the focus area (up to nine areas) containing the subject closest to the camera.</p>
 Auto	<p>The camera has nine focus areas, and automatically selects the focus areas containing the subject closest to the camera. Press the shutter-release button halfway to activate the focus area. When the shutter-release button is pressed halfway, the focus areas that are in focus (up to nine areas) selected by the camera will be displayed in the monitor.</p>

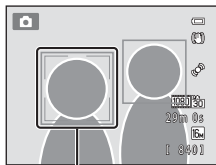



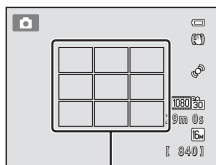







Focus area



Focus areas

The Shooting Menu (for (Auto) Mode, Continuous Shooting Mode)

Option	Description
<p> Manual</p>	<p>Select one of 99 focus areas in the monitor. This option is suited to situations in which the intended subject is relatively still and not positioned in the center of the frame.</p> <p>Rotate the multi selector or press , , , or  to move the focus area to where the subject is, and take a picture.</p> <ul style="list-style-type: none"> To change settings for any of the following functions, first press the  button to cancel focus-area selection, then change the settings as desired. <ul style="list-style-type: none"> - Flash mode, macro mode, self-timer - Brightness (exposure compensation), vividness, hue <p>To return to the focus area selection screen, press the  button again.</p>
<p> Center</p>	<p>The camera focuses on the subject in the center of the frame. The focus area is always displayed in the center of the screen.</p>
<p> Subject tracking</p>	<p>By registering a subject, the focus area will automatically move to track and focus on the subject. See "Using Subject Tracking" for more information (40).</p>

Selectable focus area

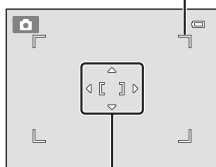

Focus area

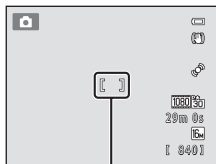



Focus area

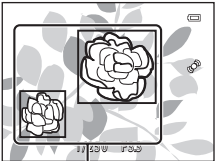

Option	Description
 Target finding AF (default setting)	<p>When the camera detects the main subject, it focuses on that subject. Press the shutter-release button halfway to activate the focus area. When the shutter-release button is pressed halfway, focus areas that suit the size of the subject are displayed in the monitor (up to 12 areas). When the main subject cannot be detected, the AF area mode setting switches to Auto, and the camera selects the focus areas (up to nine areas) containing the subject closest to the camera.</p>  <p style="text-align: center;">AF area</p>

Notes About AF Area Mode

- When digital zoom is in effect, focus will be on the center of the screen regardless of the **AF area mode** setting.
- Some settings cannot be used with other functions ( 73).
- Autofocus may not perform as expected. See "Autofocus" ( 29) for more information.
- If the camera does not focus on the desired subject when using a feature that selects and focuses on the subject, such as target finding, set **AF area mode** to **Manual** or **Center** and align the focus area with the desired subject. You may also try using focus lock ( 78).

Notes About Target Finding AF

- Depending on shooting conditions, the subject that the camera determines to be the main subject may vary.
- The camera cannot detect the main subject in the following situations: The focus area will be the same as when **AF area mode** is set to **Auto**.
 - When vividness or hue is adjusted using the creative slider
 - **White balance** is set to any setting other than **Auto**
- The camera may not detect the main subject appropriately in the following situations:
 - When the image shown in the monitor is very dark or bright
 - When the main subject lacks clearly defined colors
 - When the shot is framed such that the main subject is on the edge of the monitor
 - When the main subject is composed of a repeating pattern

Using Subject Tracking

Use this mode to take pictures of moving subjects. When you register a subject, subject tracking begins and the focus area automatically follows the subject.

1 Press the **MENU** button in (auto) mode or continuous shooting mode.

- The shooting menu or continuous shooting menu is displayed.

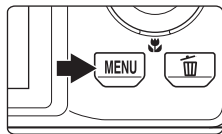

2 Use the multi selector to select **Subject tracking** in the **AF area mode** option and press the **OK** button.

- See "AF Area Mode" (37) for more information.
- Press the **MENU** button after changing the settings and return to the shooting screen.

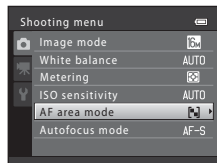

3 Register a subject.

- Align the white border in the center of the monitor with the subject that you want to register and press the **OK** button.
 - The subject is registered.
 - When the camera is unable to focus on the subject, the border will glow red. Change the composition and try registering the subject again.
- When the subject is registered, a yellow double border (focus area) is displayed around that subject.
- To cancel subject registration, press the **OK** button.
- If the camera cannot track the registered subject anymore, the focus area will disappear and the registration will be canceled. Register the subject again.

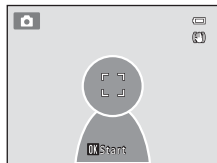



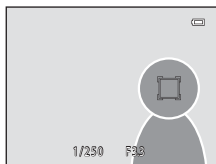

4 Press the shutter-release button the rest of the way down to take a picture.



- The camera focuses on the focus area when the shutter-release button is pressed halfway. The focus area will glow green and focus will be locked.
- If the shutter-release button is pressed halfway while the focus area is not displayed, the camera focuses on the subject in the center of the frame.



Notes About Subject Tracking

- Digital zoom cannot be used.
- Adjust zoom position, flash mode, creative slider, and menu settings prior to registering the subject. If any camera setting is changed after the subject has been registered, subject registration will be canceled.
- The camera may not be able to register or track the subject, or a different subject may be tracked, depending on shooting conditions such as if the subject is moving fast, if there is camera shake, and if there are similar looking subjects in the frame. The camera's ability to accurately track the registered subject is also dependent upon the size and brightness of the subject.
- When using autofocus and shooting subjects that are difficult to focus on ( 29), the subject may not be in focus even though the focus area glows green. If the subject is not in focus, change **AF area mode** ( 37) to **Manual** or **Center** in  (auto) mode, and try focus lock shooting ( 78) by focusing on another subject that is the same distance from the camera.
- Some settings cannot be used with other functions ( 73).

Autofocus Mode

Enter  (auto) mode or continuous shooting mode → MENU button →  or  tab → Autofocus mode

Select how the camera focuses.

Option	Description
AF-S Single AF (default setting)	The camera focuses when the shutter-release button is pressed halfway.
AF-F Full-time AF	The camera focuses continuously until the shutter-release button is pressed down halfway. Use with moving subjects. The sound of lens drive movement will be heard while the camera focuses.

Notes About Autofocus Mode

Some settings cannot be used with other functions ( 73).

Autofocus Mode for Movie Recording

Autofocus mode for movie recording can be set with **Autofocus mode** ( 59) in the movie menu.

The Playback Menu

- For information about the following image editing features, see “Editing Still Images” (🔍10):
 - Quick retouch
 - Skin softening
 - Small picture
 - D-Lighting
 - Filter effects

🖨️ Print Order (Creating a DPOF Print Order)

Press the  button (playback mode) → MENU button →  tab → 🖨️ Print order



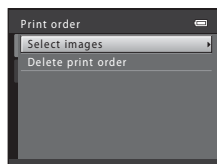

When printing images saved on the memory card using any of the following methods, the **Print order** option in the playback menu is used to create digital “print orders” for printing on DPOF-compatible devices.

- Inserting the memory card into a DPOF-compatible (🔧19) printer’s card slot.
- Taking the memory card to a digital photo lab.
- Connecting the camera to a PictBridge-compatible (🔧19) printer (🔍23). A print order can also be created for images saved in the internal memory if the memory card is removed from the camera.

- 1** Select **Select images** and press the  button.



- 2** Select images (up to 99) and the number of copies (up to nine) of each.

- Rotate the multi selector, or press  or  to select images, and press  or  to specify the number of copies to be printed.
- Images selected for printing are indicated by the check mark icon and the numeral indicating the number of copies to be printed. If no copies have been specified for images, the selection is canceled.
- Rotate the zoom control to **T** (🔍) to switch to full-frame playback. Rotate the zoom control to **W** (🖼️) to switch back to 12-thumbnail display.
- Press the  button when setting is complete.



3 Select whether or not to print shooting date and shooting information.

- Select **Date** and press the **OK** button to print the shooting date on all images.
- Select **Info** and press the **OK** button to print shooting information (shutter speed and aperture value) on all images.
- Select **Done** and press the **OK** button to apply the settings.

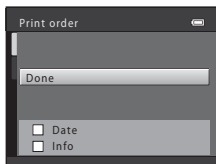

Images selected for printing are indicated by the  icon during playback.

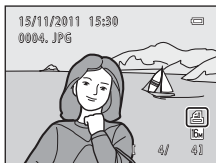



Notes About Printing Shooting Date and Shooting Information

When the **Date** and **Info** settings are enabled in the print order option, shooting date and shooting information are printed on images when a DPOF-compatible (:19) printer that supports printing of shooting date and shooting information is used.

- Shooting information cannot be printed when the camera is connected directly to a printer, via the included USB cable, for DPOF printing (.
- Note that **Date** and **Info** settings are reset each time the **Print order** option is displayed.
- The date printed is that saved when the image was captured. Changing the camera's date using the **Date and time** or **Time zone** in the **Time zone and date** option in the setup menu after an image has been captured has no effect on the date printed on the image.



Canceling Existing Print Order

Select **Delete print order** in step 1 of " Print Order (Creating a DPOF Print Order)" () and press the **OK** button to remove print marking from all images and cancel the print order.

 **Print Date**

When shooting date and time are imprinted on images using the **Print date** option (0066) in the setup menu, images are saved with shooting date and time imprinted on the image when they are captured. Images with the date imprinted on them can be printed from printers that do not support printing of the date on images.



If the **Print date** option is used to imprint the shooting date on images, the **Date** selection option of the **Print order** function has no effect.

Slide Show

Press the  button (playback mode) → MENU button →  tab →  Slide show



Play back images, saved in the internal memory or on a memory card, one by one in an automated “slide show.”

1 Use the multi selector to select **Start** and press the button.

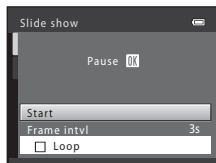
- To change the interval between images, select **Frame intvl**, select the desired interval time, and press the  button before selecting **Start**.
- To repeat the slide show automatically, select **Loop** and press the  button before selecting **Start**. The check mark () will be added to the loop option when enabled.





2 The slide show begins.

- While the slide show is in progress, press the multi selector  to display the next image or  to display the previous image. Hold down either button to fast forward or rewind.
- To end or pause the slide show, press the  button.





3 End the slide show or restart it.



- The screen shown on the right is displayed when the slide show has ended or is paused. Select  and press the  button to return to the screen displayed in step 1. Select  to play the slide show again.



Notes About Slide Show

- Only the first frame of movies included in a slide show is displayed.
- For sequences () whose sequence display options are set to **Key picture only**, only the key picture is displayed.
- Images captured using easy panorama () are displayed full-frame when played in a slide show. They do not scroll.
- The maximum playback time is up to 30 minutes even if **Loop** is enabled ()

Protect



Press the  button (playback mode) → MENU button →  tab →  Protect

Protect selected images from accidental deletion.

Select images to protect or cancel protection for previously protected images from the image selection screen.

See “The Image Selection Screen” (48) for more information.

Note that formatting the camera’s internal memory or the memory card will permanently delete protected images (73).

Protected images are indicated by the  icon during playback ( 8).

The Image Selection Screen

When using one of the following features, a screen like that shown on the right is displayed when selecting images.

- Print order > **Select images** (👁️43)
- Protect (👁️47)
- Rotate image (👁️49)
- Copy > **Selected images** (👁️52)
- Choose key picture (👁️54)
- Welcome screen > **Select an image** (👁️60)
- Delete image > **Erase selected images** (📖 32)



Follow the procedures described below to select the images.

1 Rotate the multi selector, or press ◀ or ▶ to select the desired image.

- Rotate the zoom control (📖 2) to **T** (👁️) to switch to full-frame playback or **W** (📖) to switch back to 12-thumbnail display.
- Only one image can be selected for **Rotate image**, **Choose key picture**, and **Welcome screen**. Proceed to step 3.



2 Press ▲ or ▼ to select or deselect (or to specify the number of copies).

- When an image is selected, a check mark (✔️) is displayed with the image. Repeat steps 1 and 2 to select additional images.





3 Press the (OK) button to apply image selection.

- When **Selected images** is selected, a confirmation dialog is displayed. Follow the instructions displayed in the monitor.

Rotate Image

Press the  button (playback mode) → MENU button →  tab →  Rotate image

Specify the orientation in which saved images are displayed during playback. Still images can be rotated 90 degrees clockwise or 90 degrees counterclockwise. Images that were saved in portrait (“tall”) orientation can be rotated up to 180 degrees in either direction.

Select an image from the image selection screen (48). When the Rotate image screen is displayed, rotate the multi selector or press  or  to rotate the image 90 degrees.

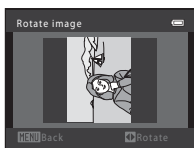

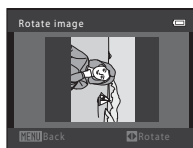

Rotate 90 degrees
counterclockwise



Rotate 90 degrees
clockwise

Press the  button to finalize display orientation, and save orientation information with the image.

Notes About Image Rotation

- The camera cannot rotate images captured with another make or model of digital camera.
- While only the key picture of a sequence is displayed, images cannot be rotated. Apply the setting after displaying individual images (, 54).





Voice Memo

Press the  button (playback mode) → select an image → MENU button →  tab →  Voice memo

Use the camera's microphone to record voice memos for images.



- For an image that has no voice memo, the voice memo recording screen is displayed; for an image that has a voice memo (i.e., an image indicated by  in full-frame playback mode), the voice memo playback screen is displayed.

Recording Voice Memos

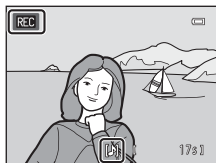
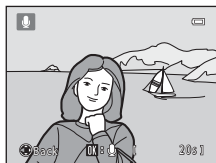
- Press and hold the  button to record a voice memo (up to 20 seconds).
- Do not touch the microphone during recording.
- During recording,  and  blink in the monitor.
- When recording ends, the voice memo playback screen is displayed. See “Playing Voice Memos” for more information.
- Press the multi selector  before or after recording a voice memo to return to the playback menu. Press the **MENU** button to exit the playback menu.



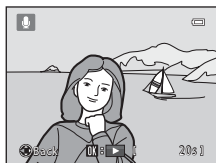

Playing Voice Memos

- Press the  button to play the voice memo.
- Press the  button again to stop playback.
- Rotate the zoom control to **T** or **W** during playback to adjust playback volume.
- Press the multi selector  before or after playing a voice memo to return to the playback menu. Press the **MENU** button to exit the playback menu.



Deleting Voice Memos

Press the  button while the screen described in “Playing Voice Memos” is displayed.

When the confirmation dialog is displayed, select **Yes** and press the  button. Only the voice memo will be deleted.





Notes About Voice Memos

- When an image with a voice memo attached is deleted, both the image and its voice memo are deleted.
- You cannot delete voice memos attached to protected images (47).
- Voice memos cannot be recorded for an image that already has a voice memo attached to it. The current voice memo must be deleted before a new voice memo can be recorded.
- Voice memos cannot be attached to pictures recorded with easy panorama.
- This camera cannot record voice memos for images captured with another make or model of digital camera.

More Information





See “File and Folder Names” (84) for more information.

Copy (Copy Between Internal Memory and Memory Card)

Press the  button (playback mode) → MENU button →  tab →  Copy



Copy images between the internal memory and a memory card.

1 Use the multi selector to select a copy destination and press the button.

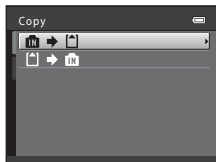
-  → : Copy images from internal memory to memory card.
-  → : Copy images from memory card to internal memory.







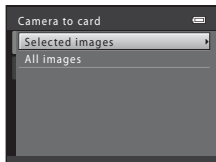

2 Select a copy option and press the button.

- **Selected images:** Copy images selected from the image selection screen (48). If a sequence for which only a key picture is displayed is selected (7), all images in the displayed sequence are copied.
- **All images:** Copy all images. If an image in a sequence is selected, this option is not displayed.
- **Current sequence:** This option is available only if an image that is in a sequence group was selected before the playback menu was displayed. All images in the current sequence are copied.



Notes About Copying Images

- JPEG-, MOV-, and WAV-format files can be copied. Files saved in any other format cannot be copied.
- If voice memo () are attached to images selected for copying, voice memos are copied with the images.
- Operation is not guaranteed with images captured with another make of camera or that have been modified on a computer.
- When copying images for which **Print order** () options are enabled, the print order settings are not copied. However, when copying images for which **Protect** () is enabled, the protect setting is copied.
- If you copy images that are in a sequence, the copied images are not part of a sequence.
- If **Sequence display options** () is set to **Key picture only** and an image in the sequence is selected and the  button is pressed to display individual images (), only  (memory card to internal memory) image copy is available.



If “Memory contains no images.” Is Displayed



If there are no images saved on a memory card inserted in the camera when playback mode is applied, the message **Memory contains no images.** will be displayed. Press the **MENU** button to display the copy options screen, and copy the images saved in the camera's internal memory to the memory card.

More Information

See “File and Folder Names” () for more information.

Sequence Display Options

Press the  button (playback mode) → MENU button →  tab →  Sequence display options



Select the method used to display a series of images shot continuously (sequence; 7) when viewing them in full-frame playback mode ( 30) and in thumbnail playback mode ( 31).

Settings are applied to all sequences, and the setting is saved in the camera's memory even if the camera is turned off.

Option	Description
Individual pictures	Set all images in all sequences to be displayed individually.
Key picture only (default setting)	Set all sequences to be displayed using their key pictures only.

Choose Key Picture

Press the  button (playback mode) → MENU button →  tab →  Choose key picture

When **Sequence display options** is set to **Key picture only**, the key picture displayed in full-frame playback mode ( 30) and thumbnail playback mode ( 31) can be set for each sequence of images.

- When changing this setting, before pressing **MENU**, first select the desired sequence using full-frame playback mode or thumbnail playback mode.
- When the key picture selection screen is displayed, select an image. See “The Image Selection Screen” (48) for more information.

The Movie Menu

Movie Options





Enter shooting mode → MENU button → 菜 tab → Movie options

Select the desired movie option to record.



In addition to normal speed movies, the camera can also record high speed (HS) movies (60/57), which can be played back in slow motion or fast motion.

Larger image sizes and faster movie bitrates mean higher image quality and larger movie file sizes.

Normal Speed Movies

Option	Description
 HD 1080p★ (1920×1080) (default setting)	Movies with an aspect ratio of 16:9 are recorded. This option is suited to playback on a wide screen TV. <ul style="list-style-type: none">• Movie bitrate: 18.8 Mbps• Frame rate: About 30 frames per second
 HD 1080p (1920×1080)	Movies with an aspect ratio of 16:9 are recorded. This option is suited to playback on a wide screen TV. <ul style="list-style-type: none">• Movie bitrate: 12.6 Mbps• Frame rate: About 30 frames per second
 HD 720p (1280×720)	Movies with an aspect ratio of 16:9 are recorded. <ul style="list-style-type: none">• Movie bitrate: 8.4 Mbps• Frame rate: About 30 frames per second
 iFrame 540 (960×540)	Movies with an aspect ratio of 16:9 are recorded. A format supported by Apple Inc. <ul style="list-style-type: none">• Movie bitrate: 20.8 Mbps• Frame rate: About 30 frames per second When recording movies to the internal memory, recording may stop unexpectedly in some shooting conditions. When recording movies of important events, recording to a memory card (Speed Class 6 or higher) is recommended.
 VGA (640×480)	Movies with an aspect ratio of 4:3 are recorded. <ul style="list-style-type: none">• Movie bitrate: 2.9 Mbps• Frame rate: About 30 frames per second

HS Movie

Option	Description
 HS 120 fps (640×480)	1/4-speed slow motion movies with a 4:3 aspect ratio are recorded. <ul style="list-style-type: none"> • Max. recording time: 7 minutes and 15 seconds (playback time: 29 minutes) • Movie bitrate: 2.8 Mbps • Frame rate: About 120 frames per second • When the shooting mode is set to special effects (📖 53), the Soft effect is not applied to movies. Only the hue of the Nostalgic sepia effect is applied.
 HS 60 fps (1280×720)	1/2-speed slow motion movies with a 16:9 aspect ratio are recorded. <ul style="list-style-type: none"> • Max. recording time: 14 minutes and 30 seconds (playback time: 29 minutes) • Movie bitrate: 8.3 Mbps • Frame rate: About 60 frames per second
 HS 15 fps (1920×1080)	2× speed fast motion movies with a 16:9 aspect ratio are recorded. <ul style="list-style-type: none"> • Max. recording time: 29 minutes (playback time: 14 minutes and 30 seconds) • Movie bitrate: 18.6 Mbps • Frame rate: About 15 frames per second

- The movie bitrate is the volume of movie data recorded per second. Variable bitrate (VBR) encoding is used to automatically adjust the bitrate depending on the subject being recorded. When recording movies of subjects with large amounts of motion, the file size increases.
- See “Movie Options and Maximum Movie Length” (📖 90) for information about recording time.

More Information

See “File and Folder Names” (🔍 84) for more information.

Recording Movies in Slow Motion and Fast Motion (HS Movie)

HS (high speed) movies can be recorded. Movies can be played back in slow motion at 1/4 or 1/2 of normal playback speed, or played back in fast motion at a speed two times faster than normal speed.

- See “HS Movie” (📷58) for more information.

- 1 Display the movie menu (📷55), use the multi selector to select **Movie options**, and then press the **OK** button.

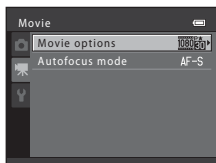

- 2 Confirm or change HS movie settings, and then press the **OK** button.

- See “Movie Options” (📷55) for more information.
- Press the **MENU** button after changing the settings and return to the shooting screen.

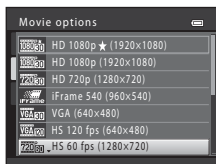

- 3 Press the **REC** (📷 movie-record) button to start recording.

- Movie recording begins after the monitor briefly turns off.
- The camera focuses in the center of the frame. Focus areas are not displayed during recording.
- The maximum movie length display indicates the maximum HS movie length.

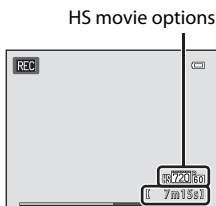

- 4 Press the **REC** (📷 movie-record) button to end recording.

✓ Notes About HS Movie

- Sound is not recorded.
- When recording HS movies, zoom position, focus, exposure, and white balance are locked when the  (movie-record) button is pressed to start recording.

HS Movie

Recorded movies are played back at about 30 frames per second.

When **Movie options** () is set to **HS 120 fps (640×480)** or **HS 60 fps (1280×720)**, you can record movies that can be played back in slow motion. When set to **HS 15 fps (1920×1080)**, movies that can be played back in fast motion at a speed two times faster than normal speed can be recorded.

When HS 120 fps (640×480) is selected:

Movies are captured for up to 7 minutes and 15 seconds at high speed, and are played back in slow motion at a speed four times slower than normal speed.

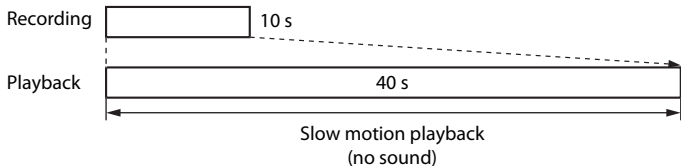

When HS 15 fps (1920×1080) is selected:

A movie of up to 29 minutes in length is recorded when shooting for the purpose of high-speed playback. Movies are played back two times faster than normal speed.

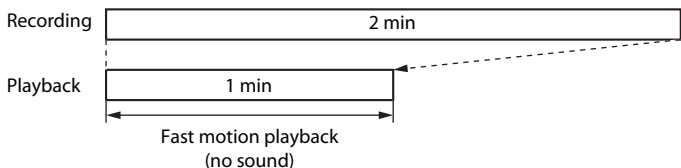

Autofocus Mode

Enter shooting mode → MENU button →  tab → Autofocus mode

Select the autofocus method used when recording normal speed movies.

Option	Description
AF-S Single AF (default setting)	Focus is locked when the ● () movie-record) button is pressed to start recording. Select this option when the distance between the camera and the subject will remain fairly consistent.
AF-F Full-time AF	Camera focuses continuously. Select this option when the distance between the camera and subject will change significantly during recording. The sound of the camera focusing may be heard in the recorded movie. Use of Single AF is recommended to prevent the sound of the camera focusing from interfering with recording.

The Setup Menu

Welcome Screen

MENU button → Y tab → Welcome screen









Select whether or not a welcome screen is displayed when the camera is turned on.

Option	Description
None (default setting)	The camera enters shooting or playback mode without displaying the welcome screen.
COOLPIX	The camera displays a welcome screen and enters shooting or playback mode.
Select an image	Displays an image selected for the welcome screen. When the image selection screen is displayed, select an image (6048) and press the OK button. <ul style="list-style-type: none">As the selected image is saved by the camera, it will be displayed when the camera is turned on even if the original image is deleted.Images captured at an Image mode (671) setting of 4608x2592, images captured with easy panorama, and copies created at a size of 320 x 240 or smaller using the small picture (6018) or crop (6019) function cannot be selected.

Time Zone and Date

MENU button →  tab → Time zone and date

Set the camera clock.

Option	Description
Date and time	<p>Set camera clock to current date and time. Use the multi selector to set the date and time in the date screen.</p> <ul style="list-style-type: none"> Select an item: Press  or  to change between D, M, Y, hour, and minute. Edit the highlighted item: Rotate the multi selector or press  or . Apply the setting: Select the minute setting and press the  button.
Date format	The available date formats are Year/Month/Day , Month/Day/Year , and Day/Month/Year .
Time zone	 Home time zone can be specified and daylight saving time can be enabled or disabled. When the travel destination () is selected, local time ( 63) is automatically calculated and images are saved with the shooting date and time of the selected region. This can be useful when travelling.

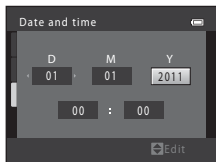

Selecting the Travel Destination Time Zone

1 Use the multi selector to select **Time zone** and press the  button.

- The **Time zone** screen is displayed.

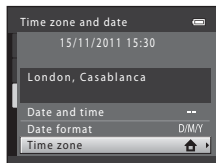

2 Select  **Travel destination** and press the  button.

- The date and time displayed in the monitor changes according to the region currently selected.

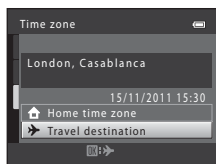

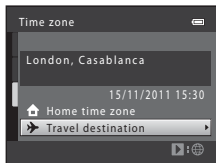

3 Press **▶**.

- The travel destination screen is displayed.



4 Press **◀** or **▶** to select the travel destination time zone.

- If daylight saving time is in effect, press **▲** to enable daylight saving time function.  is displayed at the top of the monitor and the camera clock is advanced one hour. Press **▼** to disable the daylight saving time function.
- Press the **OK** button to apply the travel destination time zone.
- While the travel destination time zone is selected, the  icon will be displayed in the monitor when the camera is in shooting mode.

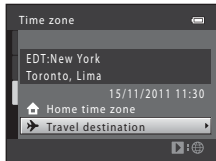
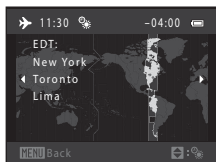

Home Time Zone

- To switch to the home time zone, select **Home time zone** in step 2 and press the **OK** button.
- To change the home time zone, select **Home time zone** in step 2, and complete steps 3 and 4.

Daylight Saving Time

When daylight saving time starts or ends, turn the daylight saving time function on or off from the time zone selection screen displayed in step 4.

Imprinting Date on Images

Enable print date from the **Print date** option () in the setup menu after the date and time have been set. When the **Print date** option is enabled, images will be saved with shooting date imprinted on them.

Time Zones

The camera supports the time zones listed below.

For time zones not listed below, set the camera clock to local time from the **Date and time** option.

UTC +/-	Location	UTC +/-	Location
-11	Midway, Samoa	+1	Madrid, Paris, Berlin
-10	Hawaii, Tahiti	+2	Athens, Helsinki, Ankara
-9	Alaska, Anchorage	+3	Moscow, Nairobi, Riyadh, Kuwait, Manama
-8	PST (PDT): Los Angeles, Seattle, Vancouver	+4	Abu Dhabi, Dubai
-7	MST (MDT): Denver, Phoenix	+5	Islamabad, Karachi
-6	CST (CDT): Chicago, Houston, Mexico City	+5.5	New Delhi
-5	EST (EDT): New York, Toronto, Lima	+6	Colombo, Dhaka
-4.5	Caracas	+7	Bangkok, Jakarta
-4	Manaus	+8	Beijing, Hong Kong, Singapore
-3	Buenos Aires, Sao Paulo	+9	Tokyo, Seoul
-2	Fernando de Noronha	+10	Sydney, Guam
-1	Azores	+11	New Caledonia
±0	London, Casablanca	+12	Auckland, Fiji

Monitor Settings

MENU button →  tab → Monitor settings

Set the options below.





Option	Description
Photo info	Select information displayed in the monitor during shooting and playback. See "Photo Info" ( 65) for more information.
Brightness	Select from five settings for monitor brightness. The default setting is 3 .

Photo Info

Select whether or not the photo information is displayed in the monitor.

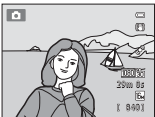
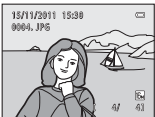
See “The Monitor” (📖 6) for information about indicators displayed in the monitor.

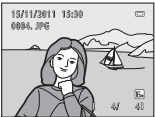
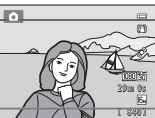

	Shooting mode	Playback mode
Show info		
Auto info (default setting)	The same information as in Show info is displayed. If no operations are performed after a few seconds, the display will be the same as Hide info . The information is displayed again when an operation is performed.	
Hide info		
Framing grid+auto info	 <p>In addition to information shown with Auto info above, a framing grid is displayed to help frame pictures. It is not displayed when recording movies.</p>	 <p>The same information as in Auto info is displayed.</p>
Movie frame+auto info	 <p>In addition to information shown with Auto info above, a frame is displayed before recording begins that represents the area that will be captured when recording movies. It is not displayed when recording movies.</p>	<p>The same information as in Auto info is displayed.</p>

Print Date (Imprinting Date and Time)

MENU button →  tab → Print date



The shooting date and time can be imprinted on the images during shooting, allowing the information to be printed even from printers that do not support date printing (44).



Option	Description
 Date	Date is imprinted on images.
 Date and time	Date and time are imprinted on images.
OFF Off (default setting)	Date and time are not imprinted on images.

The current print date setting is indicated by an icon when shooting ( 6). No icon is displayed when **Off** is selected.

Notes About Print Date

- Imprinted dates form a permanent part of image data and cannot be deleted. The date and time cannot be imprinted on images after they have been captured.
- The date cannot be imprinted in the following situations:
 - When using **Panorama** scene mode
 - When using continuous shooting mode (**Pre-shooting cache, Continuous H: 120 fps**, or **Continuous H: 60 fps**)
 - When shooting movies
- Dates imprinted at an **Image mode** setting ( 71) of **VGA 640x480** may be difficult to read. Select an **Image mode** setting of **PC 1024x768** or higher when using print date.
- The date is saved using the format selected in the setup menu's **Time zone and date** option ( 22, 61).

Print Date and Print Order

When printing from DPOF-compatible printers that support the printing of shooting date and shooting information, the date and information can be printed without imprinting this information on them using settings in the **Print order** option (43).

Vibration Reduction

MENU button →  tab → Vibration reduction

Reduce the effects of camera shake while shooting. Vibration reduction reduces blur, caused by slight hand movement known as camera shake, which commonly occurs when shooting with zoom applied or at slow shutter speeds. The effects of camera shake are reduced when recording movies, in addition to when taking still pictures.

Set **Vibration reduction** to **Off** when shooting still images while using a tripod to stabilize the camera.

Option	Description
 On (default setting)	Vibration reduction is enabled. Camera automatically detects the panning direction and only corrects for vibration due to camera shake. When the camera is panned, for example, vibration reduction reduces only vertical shake. If the camera is tilted, vibration reduction affects only horizontal shake.
OFF Off	Vibration reduction is not enabled.

The current vibration reduction setting is indicated by an icon when shooting ( 6). No icon is displayed when **Off** is selected.

















Notes About Vibration Reduction

- After turning on the camera or after switching from playback mode to shooting mode, wait for the shooting mode screen to be displayed completely before taking pictures.
- Due to characteristics of the vibration reduction function, images displayed in the camera's monitor immediately after shooting may be displayed blurry.
- Vibration reduction may be unable to completely eliminate the effects of camera shake in some situations.
- When the **Night landscape** or **Night portrait** scene modes are set to **Tripod**, vibration reduction is turned **Off**.

Motion Detection

MENU button →  tab → Motion detection

Enable motion detection to reduce the effects of subject movement and camera shake when shooting still images.

Option	Description
 Auto (default setting)	<p>When the camera detects subject movement or camera shake, the ISO sensitivity and shutter speed are automatically increased to reduce blurring. However, motion detection does not function in the following situations.</p> <ul style="list-style-type: none"> • When the flash mode is set to fill-flash • In  (auto) mode, when ISO sensitivity (34) is fixed • In the following scene modes: <ul style="list-style-type: none"> -  (night landscape) ( 41) -  (backlighting) ( 42) -  (pet portrait) ( 43) - Landscape ( 44), Sports ( 45), Night portrait ( 45), Fireworks show ( 48), Panorama (when Easy panorama is selected) ( 49) • AF area mode is set to Subject tracking (40) • In continuous shooting mode ( 50)
OFF Off	Motion detection is not enabled.

The current motion detection setting is indicated by an icon when shooting ( 6). When the camera detects camera shake or subject movement, it increases shutter speed and the motion detection icon turns green. No icon is displayed when **Off** is selected.



Notes About Motion Detection

- Motion detection may be unable to completely eliminate the effects of subject movement and camera shake in some situations.
- Motion detection may not function if the subject exhibits significant movement or is too dark.
- The images captured using motion detection may be somewhat “grainy” in appearance.

AF Assist

MENU button →  tab → AF assist



Enable or disable AF-assist illuminator, which assists autofocus operation when the subject is dimly lit.

Option	Description
Auto (default setting)	AF-assist illuminator will be used to assist the focus operation when the subject is dimly lit. The illuminator has a range of about 2.2 m (7 ft 3 in.) at the maximum wide-angle position and about 1.4 m (4 ft 7 in.) at the maximum telephoto position. Note that for some focus areas and for some scene modes, such as Museum ( 48) and Pet portrait ( 43), the AF-assist illuminator may not light even when Auto is selected.
Off	AF-assist illuminator does not light. The camera may be unable to focus under dim lighting.

Digital Zoom

MENU button →  tab → Digital zoom

Enable or disable digital zoom.

Option	Description
On (default setting)	When the camera is zoomed in to the maximum optical zoom position, rotating the zoom control to T () triggers digital zoom ( 27).
Off	Digital zoom will not be activated.

Notes About Digital Zoom

- When digital zoom is in effect, the camera focuses in the center of the frame.
- Digital zoom cannot be used in the following situations.
 - When using smile timer
 - When using the scene auto selector,  (pet portrait), **Portrait**, **Night portrait**, **Panorama** (when **Easy panorama** is selected) scene modes
 - When **AF area mode** is set to **Subject tracking**
 - When continuous shooting mode is set to **Multi-shot 16** or smile timer continuous
- While digital zoom is in effect, metering is automatically set to center-weighted metering.

Sound Settings

MENU button →  tab → Sound settings

Adjust the following sound settings.

Option	Description
Button sound	Select On (default setting) or Off . When On is selected, a beep will sound once when operations are completed successfully, twice when the camera acquires focus on the subject, and three times when an error is detected. Start-up sound will also play when the camera is turned on.
Shutter sound	Select On (default setting) or Off . The shutter sound is not heard, even if On is selected, when using continuous shooting mode ( 50), or when recording movies.

Notes About Sound Settings

Button sounds and the shutter sound are not heard when using  (pet portrait).



Auto Off

MENU button →  tab → Auto off

If no operations are performed for a specified amount of time, the monitor turns off and the camera enters standby mode (📖 21).

Select the time allowed to elapse before the camera enters standby mode from **30 s**, **1 min** (default setting), **5 min**, and **30 min**.

When the Monitor Has Turned Off to Save Power

- When the camera is in standby mode, the power-on lamp blinks.
- If no operations are performed for about three minutes, the camera will turn off automatically.
- When the power-on lamp is blinking, the following operations will turn the monitor back on.
 - Pressing the power switch, shutter-release button,  button, or  (🎬 movie-record) button
 - Rotating the mode dial

Auto Off

The time allowed to elapse before the camera enters standby mode is fixed in the following situations:

- While menus are displayed: 3 minutes (when auto off is set to **30 s** or **1 min**)
- During slide show playback: Up to 30 minutes
- When the AC Adapter EH-62F is connected: 30 minutes

Format Memory/Format Card

MENU button →  tab → Format memory/Format card

Use this option to format the internal memory or a memory card.

Formatting the internal memory or memory cards permanently deletes all data. Data that has been deleted cannot be restored. Be sure to transfer important images to a computer before formatting.

Formatting the Internal Memory

To format the internal memory, remove the memory card from the camera.

The **Format memory** option is displayed in the setup menu.

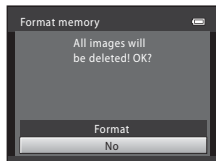

Formatting Memory Cards

When a memory card is inserted in the camera, the **Format card** option is displayed in the setup menu.

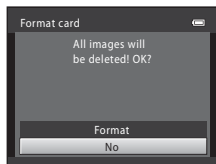

Notes About Formatting Internal Memory and Memory Cards

- Do not turn the camera off or open the battery-chamber/memory card slot cover during formatting.
- The first time you insert a memory card that has been used in another device into this camera, be sure to format it with this camera.

Language

MENU button →  tab → Language

Select one of 29 languages for display of camera menus and messages.

Čeština	Czech
Dansk	Danish
Deutsch	German
English	(default setting)
Español	Spanish
Ελληνικά	Greek
Français	French
Indonesia	Indonesian
Italiano	Italian
Magyar	Hungarian
Nederlands	Dutch
Norsk	Norwegian
Polski	Polish
Português (BR)	Brazilian Portuguese
Português (PT)	European Portuguese

Русский	Russian
Română	Romanian
Suomi	Finnish
Svenska	Swedish
Tiếng Việt	Vietnamese
Türkçe	Turkish
Українська	Ukrainian
عربي	Arabic
简体中文	Simplified Chinese
繁體中文	Traditional Chinese
日本語	Japanese
한국	Korean
ภาษาไทย	Thai
हिन्दी	Hindi

TV Settings

MENU button →  tab → TV settings

Adjust settings for connection to a TV.

Option	Description
Video mode	Select from NTSC and PAL .
HDMI	Select a resolution for HDMI output from Auto (default setting), 480p , 720p , or 1080i . When Auto is selected, the option best suited to the TV to which the camera is connected is automatically selected from 480p , 720p , or 1080i .
HDMI device control	Select whether or not the camera can receive signals from a TV that supports the HDMI-CEC standard when it is connected to the TV via HDMI. When On (default setting) is selected, the TV's remote control can be used to control the camera during playback. See "Using a TV Remote Control (HDMI Device Control)" ()22) for more information.

HDMI and HDMI-CEC

HDMI (High-Definition Multimedia Interface) is a multimedia interface. HDMI-CEC (HDMI-Consumer Electronics Control) allows compatible devices to inter-operate.

Charge by Computer

MENU button →  tab → Charge by computer

Select whether or not the battery inserted into the camera is charged when the camera is connected to a computer via the USB cable (📖 81).

Option	Description
Auto (default setting)	When the camera is connected to a computer that is running, the battery inserted into the camera is automatically charged using power supplied by the computer.
Off	The battery inserted into the camera is not charged when the camera is connected to a computer.

Notes About Connecting the Camera to a Printer

- The battery cannot be charged with connection to a printer, even if the printer complies with the PictBridge standard.
- When **Auto** is selected for **Charge by computer**, it may be impossible to print images with direct connection of the camera to some printers. If the PictBridge startup screen is not displayed in the monitor after the camera is connected to a printer and turned on, turn the camera off and disconnect the USB cable. Set **Charge by computer** to **Off** and reconnect the camera to the printer.

Notes About Charging with Connection to a Computer

- The battery cannot be charged, nor can data be transferred, when the camera is connected to a computer before the camera's display language and date and time have been set (📖 22). If the camera's clock battery (📖 23) has been exhausted, the date and time must be reset before the battery can be charged or images can be transferred with connection to a computer. In this case, use the Charging AC Adapter EH-69P (📖 16) to charge the battery and then set the camera's date and time.
- If the camera is turned off, charging will also stop.
- If the computer enters sleep mode while charging, charging will stop and the camera may be turned off.
- When disconnecting the camera from the computer, turn the camera off and then disconnect the USB cable.
- It may take longer to charge the battery with connection to a computer than with charging using the Charging AC Adapter EH-69P. Charging time increases when images are transferred while the battery is charging.
- When the camera is connected to a computer, an application installed on the computer, such as Nikon Transfer 2, may start. If the camera was connected to the computer for the sole purpose of charging the battery, exit the application.
- The camera turns off automatically if there is no communication with the computer for 30 minutes after the battery has finished charging.
- Depending upon computer specifications, settings, and power supply and allocation, it may be impossible to charge the battery using a computer connection while it is inserted into the camera.

The Charge Lamp



The following chart explains charge lamp status when the camera is connected to a computer.

Charge lamp	Description
Blinks slowly (green)	Battery charging.
Off	Battery not charging. If the charge lamp changes from slow blinking (green) to off while the power-on lamp is lit, charging is complete.
Flickers (green)	<ul style="list-style-type: none">• The ambient temperature is not suited to charging. Charge the battery indoors with an ambient temperature of 5 °C to 35 °C (41 °F to 95 °F).• The USB cable is not connected correctly, or the battery is faulty. Make sure the USB cable is connected correctly and replace the battery if necessary.• The computer is in sleep mode and is not supplying power. Wake up the computer.• The battery cannot be charged because the computer cannot supply power to the camera, due to the computer's settings or its specifications.

Blink Warning

MENU button →  tab → Blink warning

Specify whether or not the camera detects human subjects that have blinked using face detection (📖 76) when shooting in the following modes.

-  (auto) mode (when **Face priority** ( 37) is selected for AF area mode option)
- In the following scene modes:
 - Scene auto selector (📖 40)
 - **Portrait** (📖 44)
 - **Night portrait** (when **Tripod** is selected) (📖 45)

Option	Description
On	When the camera detects that one or more human subjects may have blinked in an image captured using face detection, the Did someone blink? screen is displayed in the monitor. The face of the human subject that may have closed his/her eyes is framed by a yellow border. Should this occur, check the image and determine whether or not another image should be captured. See “The Blink Warning Screen” ( 78) for more information.
Off (default setting)	Blink warning is not enabled.

Notes About Blink Warning

Blink warning does not function when using continuous shooting mode or smile timer (📖 61).

The Blink Warning Screen

When the **Did someone blink?** screen shown on the right is displayed in the monitor, the operations described below are available.

If no operations are performed within a few seconds, the camera automatically returns to shooting mode.

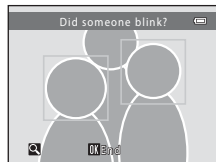

Function	Control	Description
Enlarge the detected face that blinked	T (Q)	Rotate the zoom control to T (Q).
Switch to full-frame playback mode	W (checkered flag)	Rotate the zoom control to W (checkered flag).
Select the face to be displayed		If the camera detects that more than one human subject blinked, press ◀ or ▶ to switch the display to another face.
Delete the image		Press the button.
Switch to shooting mode		Press the button or shutter-release button.

Filmstrip

MENU button →  tab → Filmstrip

Allows you to select whether or not filmstrips are displayed when you rotate the multi selector quickly in full-frame playback mode ( 30).

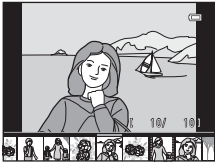
Option	Description
On	<p>Image thumbnails are displayed in the bottom of the monitor when you rotate the multi selector quickly while viewing an image in full-frame playback mode.</p> <p>You can view thumbnails of previous and subsequent images, and select an image.</p> <p>While the filmstrip is displayed, you can hide it by pressing the  button.</p> 
Off (default setting)	Disables the filmstrip.

Notes About Filmstrip Display





In order to display the filmstrip, at least ten images must be saved in the camera's internal memory or on the memory card.

Reset All







MENU button →  tab → Reset all

When **Reset** is selected, the camera's settings will be restored to their default values.





Basic Shooting Functions

Option	Default value
Flash mode ( 56)	Auto
Self-timer ( 59)	Off
Macro mode ( 64)	Off
Creative slider adjustment ( 65)	Off
Exposure compensation ( 67, 68)	0.0

Shooting Menu

Option	Default value
Image mode ( 71)	 4608x3456
White balance ( 30)	Auto
Metering ( 33)	Matrix
ISO sensitivity ( 34)	Auto
AF area mode ( 37)	Target finding AF
Autofocus mode ( 42)	Single AF

Scene Mode

Option	Default value
Scene menu ( 39)	Portrait
Night portrait ( 45)	Tripod
Hue adjustment in Food mode ( 47)	Center
Panorama ( 49)	Easy panorama (Normal (180°))

Night landscape Menu

Option	Default value
Night landscape ( 41)	Hand-held

Backlighting Menu

Option	Default value
HDR (📖 42)	Off

Pet portrait Menu

Option	Default value
Pet portrait (📖 43)	Continuous

Continuous Shooting Menu

Option	Default value
Continuous (📖 52)	Continuous

Special Effects Menu

Option	Default value
Special effects (📖 53)	Soft

Movie Menu

Option	Default value
Movie options (🎥55)	HD 1080p★ (1920x1080)
Autofocus mode (🎥59)	Single AF

Setup Menu

Option	Default value
Welcome screen (🎥60)	None
Photo info (🎥64)	Auto info
Brightness (🎥64)	3
Print date (🎥66)	Off
Vibration reduction (🎥67)	On
Motion detection (🎥68)	Auto
AF assist (🎥69)	Auto
Digital zoom (🎥70)	On
Button sound (🎥71)	On
Shutter sound (🎥71)	On
Auto off (🎥72)	1 min

The Setup Menu

Option	Default value
HDMI (🔍74)	Auto
HDMI device control (🔍74)	On
Charge by computer (🔍75)	Auto
Blink warning (🔍77)	Off
Filmstrip (🔍79)	Off

Others

Option	Default value
Paper size (🔍26, 🔍27)	Default
Frame interval for Slide show (🔍46)	3 s

- Selecting **Reset all** also clears the current file number (🔍84) from memory. Numbering will continue from the lowest number available. To reset file numbering to "0001", delete all images saved in the internal memory or on the memory card (📖 32) before selecting **Reset all**.
- The following menu settings will remain unaffected when menus are reset with **Reset all**.

Shooting menu:

Preset manual data (🔍32) acquired for **White balance**

Playback menu:

Sequence display options (🔍54), **Choose key picture** (🔍54)

Setup menu:

Time zone and date (🔍61), **Language** (🔍74), **Video mode** under **TV settings** (🔍74)

Firmware Version

MENU button →  tab → Firmware version

View the current camera firmware version.

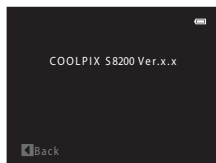

File and Folder Names

Images, movies, or voice memos are assigned file names as follows.

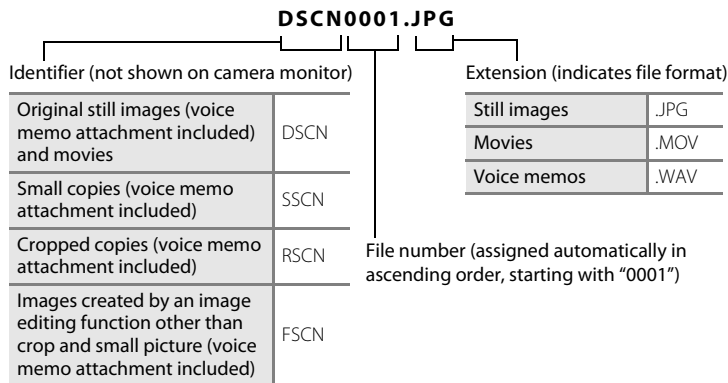

- Files are saved in folders named with a folder number followed by an identifier: "P_" plus a three-digit sequential number for images captured in **Panorama assist** scene mode (e.g. "101P_001"; 5) and "NIKON" for all other images (e.g. "100NIKON"). When the number of files within a folder reaches 9999, a new folder will be created. File numbers will be assigned automatically starting with "0001".
- Voice memo file names have the same identifier and file number as the image to which the voice memo is attached.
- Files copied using **Copy > Selected images** are copied to the current folder, where they are assigned new file numbers in ascending order starting from the largest file number in memory. **Copy > All images** copies all folders from the source medium; file names do not change but new folder numbers are assigned in ascending order, starting from the largest folder number on the destination medium (52).
- A single folder can hold up to 200 files; if the current folder already contains 200 files, a new folder, named by adding one to the current folder name, will be created the next time an image is captured. If the current folder is numbered 999 and contains 200 files, or an image is numbered 9999, no further images can be captured until the internal memory or memory card is formatted (73), or a new memory card is inserted.



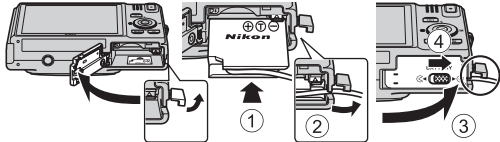







Optional Accessories















Rechargeable battery	Rechargeable Li-ion Battery EN-EL12 ¹
Charging AC adapter	Charging AC Adapter EH-69P ^{1, 2}
Battery charger	Battery Charger MH-65
AC adapter	<p>AC Adapter EH-62F (connect as shown)</p>  <p>Be sure that the power connector cord has been properly aligned in the power connector and battery chamber grooves before closing the battery-chamber/memory card slot cover. If part of the cord runs out of the grooves, the cover or cord may be damaged when the cover is closed.</p>
USB cable	USB Cable UC-E6 ¹
Audio/video cable	Audio Video Cable EG-CP16 ¹

¹ Included with the camera at the time of purchase (📖 ii).













² When using in other countries, use a plug adapter (commercially available) as necessary. For more information about plug adapters, consult your travel agency.

















Error Messages

Display	Problem	Solution	
 (blinks)	Clock not set.	Set date and time.	 61
 Battery exhausted.	Battery exhausted.	Charge or replace the battery.	14, 16
 Battery temperature high	Battery temperature is high.	Turn off camera, and allow battery to cool down before resuming use. After five seconds, this message will disappear, the monitor will turn off, and the power-on lamp will blink rapidly. After the lamp blinks for three minutes, the camera will turn off automatically. Pressing the power switch also turns off the camera.	21
 The camera will turn off to prevent overheating.	Memory card or inside of camera has become hot.	The camera turns off automatically. Leave the camera off until the memory card or the inside of the camera has cooled and then turn it on again.	–
 ● (● blinks red)	Camera cannot focus.	<ul style="list-style-type: none"> • Refocus. • Use focus lock. 	28, 29 78
 Please wait for the camera to finish recording.	Camera cannot perform other operations until saving is complete.	Wait until message clears from display automatically when saving is complete.	–
 Memory card is write protected.	Write-protect switch is in “lock” position.	Slide write-protect switch to “write” position.	–
 This card cannot be used.	Error accessing memory card.	<ul style="list-style-type: none"> • Use approved card. • Check that terminals are clean. • Confirm that memory card is correctly inserted. 	19
 This card cannot be read.			18







Display	Problem	Solution	
 Card is not formatted. Format card? Yes No	Memory card has not been formatted for use in COOLPIX S8200.	Formatting deletes all data saved on the memory card. Be sure to select No and make copies of any images which need to be kept before formatting the memory card. Select Yes and press the  button to format the memory card.	 5
 Out of memory.	Memory card is full.	<ul style="list-style-type: none"> • Select smaller image size. • Delete images. • Insert new memory card. • Remove memory card and use internal memory. 	71 32, 92 18 19
 Image cannot be saved.	Error occurred while saving image.	Format internal memory or memory card.	 73
	Camera has run out of file numbers.	Insert a new memory card or format internal memory or memory card.	18,  73
	Image cannot be used for welcome screen.	The following images cannot be registered as welcome screen. <ul style="list-style-type: none"> • Images captured at an Image mode setting of  4608x2592 • Images captured with easy panorama • Images created using the small picture or crop functions that are 320 x 240 or smaller in size 	 60
	Insufficient space to save a copy.	Delete images from destination.	32
 Sound file cannot be saved.	A voice memo cannot be attached to this file.	<ul style="list-style-type: none"> • Voice memos cannot be attached to movies. • Select an image captured with COOLPIX S8200. 	92  51
 Image cannot be modified.	Cannot edit selected image.	<ul style="list-style-type: none"> • Select images that support editing function. • Movies cannot be edited. 	 11 –
 Cannot record movie.	Time out error while saving movie on the memory card.	Select memory card with faster write speed.	18

Error Messages

Display	Problem	Solution	
 Memory contains no images.	No images in the internal memory or memory card.	<ul style="list-style-type: none"> Remove the memory card from the camera to play back images saved in the camera's internal memory. To copy image from internal memory to memory card, press the MENU button. The copy screen will be displayed and images in the internal memory can be copied to memory card. 	18  52
 File contains no image data.  This file cannot be played back.	File not created with the COOLPIX S8200.	File cannot be viewed on this camera. View file using a computer or the devices used to create or edit this file.	–
 All images are hidden.	No images available for a slide show.	–	 46
 This image cannot be deleted.	Image is protected.	Disable protection.	 47
 Travel destination is in the current time zone.	Destination in same time zone as home.	–	 63
 Mode dial is not in the proper position.	The mode dial is not set to the correct position.	Rotate the mode dial to select the desired mode.	24
 Flash is not fully raised.	Flash is being held down by fingers and other objects.	Do not hold down the flash.	26

Display	Problem	Solution	
 Unable to create panorama.	Could not shoot using easy panorama.	Shooting with easy panorama may not be possible in the following situations. <ul style="list-style-type: none"> • When shooting does not end after a certain amount of time • When the camera is moved too fast • When the camera is not moved in a straight line in the panorama direction 	 2
 Unable to create panorama. Pan the camera in one direction only.			
 Unable to create panorama. Pan the camera more slowly.			
Lens error 	Lens error.	Turn camera off and then on again. If error persists, contact retailer or Nikon-authorized service representative.	20
 Communications error	Error occurred during communication with printer.	Turn camera off and reconnect USB cable.	 24
System error 	Error has occurred in camera's internal circuitry.	Turn camera off, remove and reinsert battery, and turn camera on. If error persists, contact retailer or Nikon-authorized service representative.	14, 21
 Printer error: check printer status.	Printer error.	Check printer. After solving the problem, select Resume and press the  button to resume printing.*	–
 Printer error: check paper	Specified size of paper is not loaded in printer.	Load the specified size of paper, select Resume , and press the  button to resume printing.*	–
 Printer error: paper jam	Paper has jammed in printer.	Remove the jammed paper, select Resume , and press the  button to resume printing.*	–
 Printer error: out of paper	No paper is loaded in printer.	Load the specified size of paper, select Resume , and press the  button to resume printing.*	–

Error Messages

Display	Problem	Solution	
 Printer error: check ink	Ink error.	Check ink, select Resume , and press the  button to resume printing.*	–
 Printer error: out of ink	Running out of ink or ink cartridge is empty.	Replace ink cartridge, select Resume , and press the  button to resume printing.*	–
 Printer error: file corrupt	An error caused by the image file has occurred.	Select Cancel and press the  button to cancel printing.	–

* See the documentation provided with your printer for further guidance and information.



Technical Notes and Index

Caring for the Product	2
The Camera.....	2
The Battery.....	4
Charging AC Adapter.....	5
Memory Cards.....	5
Cleaning and Storage	6
Cleaning.....	6
Storage.....	6
Troubleshooting	7
Specifications	15
Supported Standards.....	19
Index	20

Caring for the Product

The Camera

To ensure continued enjoyment of this Nikon product, observe the following precautions when using or storing the device.

Do Not Drop

The product may malfunction if subjected to strong shock or vibration.

Handle the Lens and All Moving Parts with Care

Do not apply force to the lens, lens cover, monitor, memory card slot, or battery chamber. These parts are easily damaged. Applying force to the lens cover could result in camera malfunction or damage to the lens. Should the monitor break, care should be taken to avoid injury caused by broken glass and to prevent the liquid crystal from the display touching the skin or entering the eyes or mouth.

Keep Dry

The device will be damaged if immersed in water or subjected to high humidity.

Avoid Sudden Changes in Temperature

Sudden changes in temperature, such as when entering or leaving a heated building on a cold day, can cause condensation to form inside the device. To prevent condensation, place the device in a carrying case or a plastic bag before exposing it to sudden changes in temperature.

Keep away from Strong Magnetic Fields

Do not use or store this device in the vicinity of equipment that generates strong electromagnetic radiation or magnetic fields. Strong static charge or the magnetic fields produced by equipment such as radio transmitters could interfere with the monitor, damage data saved on the memory card, or affect the product's internal circuitry.

Do Not Point the Lens at Strong Light Sources for Extended Periods

Avoid pointing the lens at the sun or other strong light sources for extended periods when using or storing the camera. Intense light may cause deterioration of the image sensor, producing a white blur effect in photographs.

Turn the Product off Before Removing or Disconnecting the Power Source

Do not remove the battery while the product is on, or while images are being saved or deleted. Forcibly cutting power in these circumstances could result in loss of data or in damage to product memory or internal circuitry.

✔ Notes About the Monitor

- The monitor may contain a few pixels that are always lit or that do not light. This is a characteristic common to all TFT LCD displays, and does not indicate a malfunction. Images saved using the product will not be affected.
- Images in the monitor may be difficult to see under bright lighting.
- The monitor is lit by an LED backlight. Should the monitor begin to dim or flicker, contact your Nikon-authorized service representative.

The Battery

- Check the battery level before using the camera and replace or charge the battery if necessary. Do not continue charging once the battery is fully charged as this will result in reduced battery performance. Whenever possible, carry a fully charged spare battery when taking pictures on important occasions.
- Do not use the battery at ambient temperatures below 0 °C (32 °F) or above 40 °C (104 °F).
- Charge the battery indoors with an ambient temperature of 5 °C to 35 °C (41 °F to 95 °F) before use.
- When charging the camera using the Charging AC adapter EH-69P or a computer, the charge capacity may decrease at ambient temperatures 45 °C to 60 °C (113 °F to 140 °F).
- The battery is not charged at ambient temperatures below 0 °C (32 °F) or above 60 °C (140 °F).
- Note that the battery may become hot during use; wait for the battery to cool before charging. Failure to observe these precautions could damage the battery, impair its performance, or prevent it from charging normally.
- On cold days, the capacity of batteries tends to decrease. If an exhausted battery is used at a low temperature, the camera not turn on. Be sure that the battery is fully charged before heading outside to take pictures in cold weather. Keep spare batteries in a warm place and exchange as necessary. Once warmed, a cold battery may recover some of its charge.
- Dirt on the battery terminals can prevent the camera from functioning. Should the battery terminals become dirty, wipe them off with a clean, dry cloth before use.
- If the battery will not be used for some time, insert it in the camera and run it flat before removing it for storage. The battery should be stored in a cool location with an ambient temperature of 15 to 25 °C (59 to 77 °F). Do not store the battery in hot or extremely cold locations.
- Always remove the battery from the camera or optional battery charger when it is not being used. When inserted, minute amounts of current are drawn from the battery even when not in use. This may result in excessive draining of the battery and complete loss of function. Turning the camera on or off while the battery is exhausted can result in reduced battery life.
- Recharge the battery at least once every six months and completely exhaust it before returning it to storage.
- After removing the battery from the camera or optional battery charger, replace the included terminal cover and store it in a cool place.
- A marked drop in the time a fully-charged battery retains its charge, when used at room temperature, indicates that the battery needs to be replaced. Purchase a new EN-EL12 battery.
- Replace the battery when it no longer holds a charge. Used batteries are a valuable resource. Please recycle used batteries in accordance with local regulations.

Charging AC Adapter

- The Charging AC Adapter EH-69P is for use only with compatible devices. Do not use with another make or model of device.
- The EH-69P is compatible with AC 100-240 V, 50/60 Hz electrical outlets. When using in other countries, use a plug adapter (commercially available) as necessary. For more information about plug adapters, consult your travel agency.
- Do not, under any circumstances, use another make or model of AC adapter other than Charging AC Adapter EH-69P or USB-AC adapter. Failure to observe this precaution could result in overheating or in damage to the camera.

Memory Cards

- Use only Secure Digital memory cards. See “Approved Memory Cards” (📖 19) for recommended memory cards.
- Observe the precautions noted in the documentation included with your memory card.
- Do not affix labels or stickers to the memory card.
- Do not format the memory card using a computer.
- Before using a memory card with this camera, we recommend using this camera to format the memory card, especially if the memory card was used previously in another device.
- Note that **formatting a memory card permanently deletes all images and other data on the memory card**. If there is data saved on the memory card that you wish to keep, copy that data to a computer before formatting.
- If the message **Card is not formatted. Format card?** is displayed when the camera is turned on, the memory card must be formatted. If there is data on the memory card that you do not want to delete, select **No** and press the **ⓧ** button. Copy that data to a computer before formatting. To format the memory card, select **Yes**.
- Observe the following precautions while formatting the memory card, saving and deleting images, and copying images to a computer, otherwise data or the memory card itself may be damaged.
 - Do not open the battery-chamber/memory card slot cover or remove the memory card or battery.
 - Do not turn off the camera
 - Do not disconnect the AC adapter

Cleaning and Storage

Cleaning

Lens	Avoid touching glass parts with your fingers. Remove dust or lint with a blower (typically a small device with a rubber bulb attached to one end that is pumped to produce a stream of air out the other end). To remove fingerprints or other stains that cannot be removed with a blower, wipe the lens with a soft cloth, using a spiral motion that starts at the center of them and working toward the edges. If this fails, clean the lens using a cloth lightly dampened with commercial lens cleaner.
Monitor	Remove dust or lint with a blower. To remove fingerprints and other stains, clean the monitor with a soft, dry cloth, being careful not to apply pressure.
Body	Use a blower to remove dust, dirt, or sand, then wipe gently with a soft, dry cloth. After using the camera at the beach or other sandy or dusty environment, wipe off any sand, dust, or salt with a dry cloth lightly dampened with fresh water and dry thoroughly. Note that foreign matter inside the camera could cause damage not covered by the warranty.

Do not use alcohol, thinner, or other volatile chemicals.

Storage

Turn the camera off when not in use. Be sure that the power-on lamp is off before putting the camera away. Remove the battery if the camera will not be used for an extended period. Do not store the camera with naphtha or camphor moth balls, or in any of the following locations:





- Next to equipment that produces strong electromagnetic fields, such as televisions or radios
- Exposed to temperatures below -10°C (14°F) or above 50°C (122°F)
- Places that are poorly ventilated or subject to humidity of over 60%

To prevent mold or mildew, take the camera out of storage at least once a month. Turn the camera on and release the shutter a few times before putting the camera away again.











Troubleshooting

If the camera fails to function as expected, check the list of common problems below before consulting your retailer or Nikon-authorized service representative.

Power, Display, Settings Issues

Problem	Cause/Solution	
The battery inserted in the camera cannot be charged.	<ul style="list-style-type: none"> • Confirm all connections. • Off is selected for Charge by computer in the setup menu. • When charging by connecting the camera to a computer, battery charging stops when the camera is turned off. • When charging by connecting the camera to a computer, battery charging stops when the computer is suspended (sleeping), and the camera may turn off. • Depending upon computer specifications, settings, and status, charging the battery inserted in the camera may not be possible via computer connection. 	16 96,  75 96 96 –
Camera cannot be turned on.	<ul style="list-style-type: none"> • Battery is exhausted. • The camera cannot be turned on while connected to an electrical outlet via the Charging AC Adapter. 	20 16
Camera turns off without warning.	<ul style="list-style-type: none"> • Battery is exhausted. • Camera has turned off automatically to save power. • The camera and battery may not perform properly if they are cold. • The camera turns off if the Charging AC Adapter is connected while the camera is on. • The camera turns off if the USB cable connecting it to a computer or printer is disconnected. Reconnect the USB cable. • Inside of the camera has become hot. Leave the camera off until the inside of the camera has cooled, and then try turning it on again. 	20 95  4 16 81, 84,  24 –

Troubleshooting







Problem	Cause/Solution	
Monitor is blank.	<ul style="list-style-type: none"> • Camera is off. • Standby mode for saving power: press the power switch, shutter-release button,  button, or  (movie-record) button, or rotate the mode dial. • When flash lamp blinks, wait until flash has charged. • Camera and computer are connected via USB cable. • Camera and TV are connected via A/V cable or HDMI cable. 	21 2, 21 56 81, 84 81,  21
Monitor is hard to read.	<ul style="list-style-type: none"> • Adjust monitor brightness. • Monitor is dirty. Clean monitor. 	94,  64  6
Date and time of recording are not correct.	<ul style="list-style-type: none"> • If camera clock has not been set, "Date not set" indicator blinks during shooting and movie recording. Images and movies saved before clock is set are dated "00/00/0000 00:00" or "01/01/2011 00:00" respectively. Set the correct time and date from the Time zone and date option in the setup menu. • Check camera clock regularly against more accurate timepieces and reset as required. 	22, 94,  61
No indicators displayed in monitor.	Hide info is selected for Photo info . Select Show info .	94,  64
Print date not available.	Camera clock has not been set.	22, 94,  61
Date not imprinted on images even when Print date is enabled.	<ul style="list-style-type: none"> • The current shooting mode is one that does not support Print date. • The date cannot be imprinted on movies. 	94,  66 –
Screen for setting time zone and date is displayed when camera is turned on.	Clock battery is exhausted; all settings were restored to their default values.	22, 23
Camera settings reset.		
Monitor turns off, and the power-on lamp blinks rapidly.	Battery temperature is high. Turn off camera and allow battery to cool down before resuming use. After the lamp blinks for three minutes, the camera will turn off automatically. Pressing the power switch also turns off the camera.	21









Problem	Cause/Solution	
Camera becomes hot.	The camera may become hot when shooting movies for an extended period of time or when the camera is used in a hot area; this is not a malfunction.	-

Characteristics of Digital Cameras











In extremely rare instances, unusual characters may appear in the monitor and the camera may stop functioning. In most cases, this phenomenon is caused by a strong external static charge. Turn the camera off, remove and replace the battery, then turn the camera on again. In the event of continued malfunction, contact your retailer or Nikon-authorized service representative. Note that disconnecting the power source as described above may result in the loss of any data not saved to internal memory or the memory card at the time the problem occurred. Data already saved will not be affected.

Shooting Issues









Problem	Cause/Solution	
Cannot switch to shooting mode.	Disconnect HDMI cable or USB cable.	81, 84,  21,  24
No image captured when the shutter-release button is pressed.	<ul style="list-style-type: none"> • When camera is in playback mode, press the  button or shutter-release button. • When menus are displayed, press the MENU button. • Battery is exhausted. • When flash lamp blinks, flash is charging. 	9, 30 11 20 56
Camera cannot focus.	<ul style="list-style-type: none"> • Subject is too close. Try shooting using macro mode, or the Scene auto selector or Close-up scene modes. • The intended subject is one with which autofocus does not perform well. • Set AF assist in the setup menu to Auto. • Turn camera off and then on again. 	40, 47, 64 29 95,  69 21
Colored stripes appear in monitor when shooting.	Colored stripes may appear when shooting subjects with repeating patterns (such as window blinds); this is not a malfunction. The colored stripes will not appear in captured images or recorded movies. However, when using Continuous H: 120 fps or HS 120 fps (640x480) , the colored stripes may be seen in the captured images and recorded movies.	–
Images are blurred.	<ul style="list-style-type: none"> • Use flash. • Increase ISO sensitivity. • Enable vibration reduction or motion detection. • Use BSS (best shot selector). • Use tripod and self-timer. 	56 37 94, 95 48, 52,  35 59
Bright specks appear in images captured with flash.	Flash is reflecting off particles in air. Set the flash mode setting to  (off).	57

Problem	Cause/Solution	
Flash does not fire.	<ul style="list-style-type: none"> • The flash mode is set to  (off). • Scene mode with which the flash does not fire is selected. • Flash is not fully raised. Do not hold down the flash. • Another function that restricts flash is enabled. 	56 70 26 73
Digital zoom cannot be used.	<ul style="list-style-type: none"> • Digital zoom is set to Off in the setup menu. • Digital zoom cannot be used in the following situations: <ul style="list-style-type: none"> - When using smile timer - When using the scene auto selector,  (pet portrait), Portrait, Night portrait, or Panorama (when Easy panorama is selected) scene modes - When AF area mode is set to Subject tracking - When continuous shooting mode is set to Multi-shot 16 or continuous smile timer 	95,  70 61 40, 43, 44, 45, 49 37 52
Image mode not available.	Another function that restricts the Image mode option is enabled.	73
No sound when shutter is released.	Off is selected for Sound settings > Shutter sound in the setup menu. No sound is heard with some shooting modes and settings, even when On is selected.	95,  71
AF-assist illuminator does not light.	Off is selected for the AF assist option in the setup menu. AF-assist illuminator may not light depending on the position of the focus area or the current scene mode, even when Auto is selected.	95,  69
Images appear smeared.	Lens is dirty. Clean lens.	 6
Colors are unnatural.	White balance or hue is not adjusted properly.	37, 47, 65,  30
Randomly spaced bright pixels ("noise") appear in image.	Shutter speed is too slow or ISO sensitivity is high as the subject is dark. Noise can be reduced by: <ul style="list-style-type: none"> • Using flash. • Specifying a lower ISO sensitivity setting. 	56 37,  34





Troubleshooting

Problem	Cause/Solution	
Images are too dark (underexposed).	<ul style="list-style-type: none"> • The flash mode is set to  (off). • Flash window is blocked. • Subject is beyond flash range. • Adjust exposure compensation. • Increase ISO sensitivity. • Subject is backlit. Select  (backlighting) or set the flash mode to  (fill flash). 	56 26 56 67, 68 37,  34 42, 56
Images are too bright (overexposed).	Adjust exposure compensation.	67, 68
Unexpected results when flash set to  (auto with red-eye reduction).	When using  (auto with red-eye reduction) or the Night portrait to take pictures using the flash, In-Camera Red Eye Fix may be applied to areas not affected by red-eye in rare cases. Use any shooting mode other than Night portrait , change the flash mode to any setting other than  (auto with red-eye reduction), and then try taking a picture again.	45, 56
Saving images takes time.	It may take more time to save images in the following situations. <ul style="list-style-type: none"> • When the noise reduction function has been activated automatically, such as when shooting in a dark environment • When the flash mode is set to  (auto with red-eye reduction). • When taking pictures in the following scene modes. <ul style="list-style-type: none"> -  (night landscape) -  (backlighting) (when HDR is set to any setting other than Off) - Portrait, Landscape (when Noise reduction burst is selected), Night portrait • When using continuous shooting mode. 	– 57 41 42 44, 45 50
A ring-shaped belt or rainbow-colored stripe appears in the monitor or images.	When shooting with backlighting or when a very strong light source (such as sunlight) is in the frame, a ring-shaped belt or rainbow-colored stripe (ghosting) may occur. Change the position of the light source, or frame the picture so that the light source does not enter the frame and try again.	–

Playback Issues

Problem	Cause/Solution	
File cannot be played back.	<ul style="list-style-type: none"> • File or folder was overwritten or renamed by computer or other make of camera. • The COOLPIX S8200 is not able to play back movies recorded with another make or model of digital camera. 	<p>–</p> <p>92</p>
Cannot zoom in on image.	<ul style="list-style-type: none"> • Playback zoom cannot be used with movies, small pictures, or images that have been cropped to a size of 320 × 240 or smaller. • The COOLPIX S8200 may not be able to zoom in on images captured with another make or model of digital camera. 	<p>–</p>
Cannot record voice memos.	<ul style="list-style-type: none"> • Voice memos cannot be attached to movies. • Voice memos can only be attached to images captured with the COOLPIX S8200. Voice memos attached to images using another camera cannot be played back on this camera. 	<p>–</p> <p>80, 50</p>
Cannot use quick retouch, D-Lighting, skin softening, filter effects, small picture, or crop.	<ul style="list-style-type: none"> • These options cannot be used with movies. • Images captured at an Image mode setting of  4608×2592 cannot be edited, and the same editing feature cannot be applied multiple times. • The camera cannot edit images captured with another make or model of digital camera. 	<p>–</p> <p>80, 10</p> <p>11</p> <p>80, 10</p> <p>11</p>
Images not displayed on TV.	<ul style="list-style-type: none"> • Video mode or HDMI is not correctly set in the TV settings setup menu. • Memory card contains no images. Replace the memory card. Remove the memory card to play back images from the internal memory. 	<p>95, 74</p> <p>18</p>
Nikon Transfer 2 does not start when camera is connected.	<ul style="list-style-type: none"> • Camera is off. • Battery is exhausted. • USB cable is not correctly connected. • Camera is not recognized by the computer. • Confirm system requirements. • Computer is not set to start Nikon Transfer 2 automatically. <p>For more information about Nikon Transfer 2, refer to help information contained in ViewNX 2.</p>	<p>21</p> <p>20</p> <p>81, 84</p> <p>–</p> <p>82</p> <p>84</p>

Troubleshooting

Problem	Cause/Solution	
<p>The PictBridge startup screen is not displayed when the camera is connected to a printer.</p>	<p>With some PictBridge-compatible printers, the PictBridge startup screen may not be displayed and it may be impossible to print images when Auto is selected for the Charge by computer option in the setup menu. Set the Charge by computer option to Off and reconnect the camera to the printer.</p>	<p>96, 75</p>
<p>Images to be printed are not displayed.</p>	<ul style="list-style-type: none"> • Memory card contains no images. Replace the memory card. • Remove the memory card to print images from the internal memory. 	<p>18</p>
<p>Cannot select paper size with camera.</p>	<p>Paper size cannot be selected from the camera in the following situations, even when printing from a PictBridge-compatible printer. Use the printer to select paper size.</p> <ul style="list-style-type: none"> • The printer does not support the paper sizes specified by the camera. • The printer automatically selects the paper size. 	<p>81, 26, 27 –</p>

Specifications

Nikon COOLPIX S8200 Digital Camera

Type	Compact digital camera
Effective pixels	16.1 million
Image sensor	¹ / _{2.3} -in. type CMOS; approx. 16.79 million total pixels
Lens	14x optical zoom, NIKKOR lens
Focal length	4.5-63.0mm (angle of view equivalent to that of 25-350 mm lens in 35mm [135] format)
f/-number	f/3.3-5.9
Construction	11 elements in 10 groups (2 ED lens elements)
Digital zoom	Up to 2x (angle of view equivalent to that of approx. 700 mm lens in 35mm [135] format)
Vibration reduction	Lens shift
Autofocus (AF)	Contrast-detect AF
Focus range (from the center of the front of the lens)	<ul style="list-style-type: none">• [W]: Approx. 50 cm (1 ft 8 in.) to ∞, [T]: Approx. 1.0 m (3 ft 4 in.) to ∞• Macro mode: Approx. 1 cm (0.4 in.) to ∞ (wider than )
Focus-area selection	Face priority, auto (9-area automatic selection), manual with 99 focus areas, center, subject tracking, Target finding AF
Monitor	7.5 cm (3-in.), approx. 921k-dot, wide viewing angle TFT LCD with anti-reflection coating and 5-level brightness adjustment
Frame coverage (shooting mode)	Approx. 100% horizontal and 100% vertical
Frame coverage (playback mode)	Approx. 100% horizontal and 100% vertical
Storage	
Media	Internal memory (approx. 89 MB), SD/SDHC/SDXC memory card
File system	DCF, Exif 2.3, and DPOF compliant
File formats	Still pictures: JPEG Sound files (Voice Memo): WAV Movies: MOV (Video: H.264/MPEG-4 AVC, Audio: AAC stereo)

Specifications

Image size (pixels)	<ul style="list-style-type: none"> • 16M (High) [4608 × 3456★] • 16M [4608 × 3456] • 12M [4000 × 3000] • 8M [3264 × 2448] • 5M [2592 × 1944] • 3M [2048 × 1536] • PC [1024 × 768] • VGA [640 × 480] • 16:9 [4608 × 2592]
ISO sensitivity (Standard output sensitivity)	<ul style="list-style-type: none"> • ISO 100, 200, 400, 800, 1600, 3200 • Auto (auto gain from ISO 100 to 1600) • Fixed range auto (ISO 100 to 400, ISO 100 to 800)
Exposure	
Metering	224-segment matrix, center-weighted
Exposure control	Programmed auto exposure with motion detection and exposure compensation (–2.0 to +2.0 EV in steps of $\frac{1}{3}$ EV)
Shutter	Mechanical and CMOS electronic shutter
Speed	<ul style="list-style-type: none"> • 1/1600 to 1 s (when ISO sensitivity is set to Auto, Fixed range auto, 1600) • 1/1600 to 4 s (when ISO sensitivity is set to 100, 200, 400) • 1/1600 to 2 s (when ISO sensitivity is set to 800) • 1/1600 to 1/2 s (when ISO sensitivity is set to 3200) • 1/4000 to 1/125 s (Continuous H: 120 fps) • 1/4000 to 1/60 s (Continuous H: 60 fps) • 4 s (Fireworks show scene mode)
Aperture	Electronically-controlled ND filter (–2 AV) selection
Range	2 steps (f/3.3 and f/6.6 [W])
Self-timer	Can be selected from 10 s and 2 s
Built-in flash	
Range (approx.) (ISO sensitivity: Auto)	[W]: Approx. 0.5 to 5.5 m (1 ft 8 in. to 18 ft) [T]: Approx. 1.0 to 3.0 m (3 ft 4 in. to 9 ft 10 in.)
Flash control	TTL auto flash with monitor preflashes
Interface	Hi-Speed USB
Data transfer protocol	MTP, PTP
Video output	Can be selected from NTSC and PAL
HDMI output	Can be selected from Auto , 480p , 720p , and 1080i
I/O terminal	Audio/video (A/V) output; digital I/O (USB), HDMI mini connector (Type C) (HDMI output)

Supported languages	Arabic, Chinese (Simplified and Traditional), Czech, Danish, Dutch, English, Finnish, French, German, Greek, Hindi, Hungarian, Indonesian, Italian, Japanese, Korean, Norwegian, Polish, Portuguese (European and Brazilian), Romanian, Russian, Spanish, Swedish, Thai, Turkish, Ukrainian, Vietnamese
Power sources	One Rechargeable Li-ion Battery EN-EL12 (included) AC Adapter EH-62F (available separately)
Charging time	Approx. 4 hours (when using Charging AC Adapter EH-69P and when no charge remains)
Battery life (EN-EL12)	Still pictures*: Approx. 250 shots Movies: Approx. 1 h 10 min (HD 1080p★) The maximum file size for a single movie is 4 GB and the maximum movie length for a single movie is 29 minutes, even when there is sufficient free space on the memory card for longer recording.
Tripod socket	1/4 (ISO 1222)
Dimensions (W × H × D)	Approx. 103.7 × 59.3 × 32.7 mm (4.1 × 2.4 × 1.3 in.) (excluding projections)
Weight	Approx. 213 g (7.6 oz) (including battery and SD memory card)
Operating environment	
Temperature	0°C to 40°C (32°F to 104°F)
Humidity	Less than 85% (no condensation)

- Unless otherwise stated, all figures are for a camera with a fully-charged Rechargeable Li-ion Battery EN-EL12 operated at an ambient temperature of 25°C (77°F).

* Based on Camera and Imaging Products Association (CIPA) standards for measuring the life of camera batteries. Measured at 23 (±2)°C (73 (±4)°F); zoom adjusted with each shot, flash fired with every other shot, image mode set to **4608×3456**. Battery life may vary depending on shooting interval and length of time menus and images are displayed.

Rechargeable Li-ion Battery EN-EL12

Type	Rechargeable lithium-ion battery
Rated capacity	DC 3.7 V, 1050 mAh
Operating temperature	0°C to 40°C (32°F to 104°F)
Dimensions (W × H × D)	Approx. 32 × 43.8 × 7.9 mm (1.3 × 1.7 × 0.3 in.)
Weight	Approx. 22.5 g (0.8 oz) (excluding terminal cover)

Charging AC Adapter EH-69P

Rated input	AC 100-240 V, 50/60 Hz, 0.068-0.042 A
Rated capacity	6.8-10.1 VA
Rated output	DC 5.0 V, 550 mA
Operating temperature	0°C to 40°C (32°F to 104°F)
Dimensions (W × H × D)	Approx. 55 × 22 × 54 mm (2.2 × 0.9 × 2.2 in.) (excluding plug adapter) For Argentina: Approx. 55 × 59 × 63 mm (2.2 × 2.4 × 2.5 in.) For Brazil and Korea: Approx. 55 × 59 × 66.5 mm (2.2 × 2.4 × 2.6 in.)
Weight	Approx. 55 g (2.0 oz) (excluding plug adapter) For Argentina, Brazil, and Korea: Approx. 80 g (2.9 oz)

✓ Specifications

Nikon will not be held liable for any errors this manual may contain. The appearance of this product and its specifications are subject to change without notice.

Supported Standards

- **DCF:** Design Rule for Camera File System is a standard widely used in the digital camera industry to ensure compatibility among different makes of camera.
- **DPOF:** Digital Print Order Format is an industry-wide standard that allows images to be printed from print orders saved on memory cards.
- **Exif version 2.3:** Exchangeable image file format (Exif) version 2.3 for digital still cameras is a standard that allows information saved with photographs to be used for optimal color reproduction when images are output from Exif-compliant printers.
- **PictBridge:** A standard developed cooperatively by the digital camera and printer industries, allowing photographs to be output directly to a printer without connecting the camera to a computer.

Index

Symbols

AE/AF-L 

T (tele) 27

W (wide) 27

 movie-record) button 4, 5

MENU button 4, 5, 11, 37, 91, 94

 Apply selection button 5, 10

 Auto mode 24, 36

 Backlighting 42

 Continuous shooting mode 50, 52

 Delete button 4, 5, 32, 

 Exposure compensation 68

 Flash mode 56

 Help 39

 Image thumbnail display 31

 Macro mode 64

 Night landscape 41

 Pet portrait 43

 Playback button 4, 5, 9, 30

 Playback menu 80, 

 Playback zoom 31

 Scene 39

 Scene auto selector 40

 Self timer 59

 Setup menu 94

EFFECTS Special Effects Mode 53

A

AC adapter 17, 

AF area mode 37, 

AF assist 95, 

Aperture value 28



Audio/video cable 81,  



Audio/video-in jack 81, 

Auto 57

Auto mode 24, 36

Auto off 21, 95, 

Autofocus 38, 64, 91,  

Autofocus mode 38, 91,  

B

Backlighting  42

Battery 14, 16

Battery chamber 3

Battery charger 17, 

Battery latch 3

Battery level 20

Battery-chamber/memory card slot cover
14, 18

Beach  46

Best shot selector 48, 52, 

Black and white copy  48

Blink warning 96, 

Brightness 94, 

BSS 48, 52, 

Button sound 

C

Calendar display 31

Center-weighted 

Charge by computer 96, 

Charge lamp 3, 17, 

Charger 16, 

Charging AC Adapter 16, 

Choose key picture 80, 

Close-up  47

Compression ratio 71

Computer 81, 84

Connector cover 3

Continuous menu 52

Continuous shooting 52, 

Continuous shooting mode 50

Copy 80, 

Creative Slider 65

Crop 31, 

D

Date and time 22, 94, 

Date format 22, 

Daylight saving time 23, 94, 

Delete 32,  

Digital zoom 27, 95, 70
 Direct print 81, 23
 D-Lighting 80, 13
 DPOF 19
 DPOF print 29
 DSCN 84
 Dusk/dawn 46

E

Easy panorama 49, 2
 Easy panorama playback 4
 EH-69P 16, 85
 EN-EL12 14, 16, 85
 Exposure compensation 65, 68
 Extension 84
 Eyelet for camera strap 3

E

Face detection 76
 Face priority 37, 37
 File name 84
 Fill flash 57
 Filmstrip 96, 79
 Filter effects 80, 16
 Fireworks show 48
 Firmware version 96, 83
 Fixed range auto 34
 Flash 30
 Flash lamp 56
 Flash mode 56, 57
 Flash off 57
 Focus 28, 37, 37
 Focus indicator 7
 Focus lock 78
 Folder name 84
 Food 47
 Format internal memory 95, 73
 Format memory 95, 73
 Format memory card 18, 95, 73
 Formatting 18, 95, 73
 FSCN 84
 Full-frame display 30
 Full-time AF 38, 91, 42, 59

H

HDMI 74
 HDMI cable 81, 21
 HDMI device control 74
 HDMI mini connector 3
 Help 39
 High-speed continuous 52, 35
 Histogram 8, 67
 HS movie 91, 57
 Hue 65

I

Identifier 84
 Image mode 71
 Imprinting Date and Time 23, 66
 Internal memory 19
 ISO sensitivity 37, 34

J

JPG 84





L

Landscape 44
 Language 95, 74
 Lens 2, 15
 Lens cover 2

M

Macro mode 64
 Matrix 33
 Maximum movie length 90
 Memory capacity 20
 Memory card 18
 Memory card slot 18
 Metering 37, 33
 Microphone 2
 Mode dial 4, 5
 Monitor 6, 6
 Monitor settings 94, 64
 Motion detection 95, 68
 MOV 84
 Movie menu 91
 Movie options 91, 55
 Movie playback 92























Index

Movie recording 88
Multi selector 4, 5, 10
Multi-shot 16 52, 36
Museum  48
N
Night landscape  41
Night portrait  45
Nikon Transfer 2 82, 83, 85
Number of exposures remaining 20, 72

O

Optical zoom 27
Optional accessories 85





P

Panorama assist 49, 5
Panorama Maker 5 49, 83, 6
Panorama  49
Paper size 26, 27
Party/indoor  46
Pet portrait auto release 43
Pet portrait  43
Photo info 94, 64
PictBridge 81, 23, 19
Playback 30, 92, 50
Playback menu 80, 43
Playback mode 9
Playback zoom 31
Portrait  44
Power 20, 21
Power switch 20, 21
Power-on lamp 20, 21
Preset manual 32
Pre-shooting cache 52, 35
Pressing halfway 4
Print 26, 27, 43
Print date 23, 94, 66
Print order 80, 43
Print order date option 23, 44
Printer 81, 23
Protect 80, 47















Q

Quick retouch 80, 12

R

Rechargeable battery 85
Rechargeable Li-ion battery 14, 16
Recording slow motion movies 57
Red-eye reduction 57
Reset all 96, 80
Rotary multi selector 4, 5, 10
Rotate image 80, 49
RSCN 84

S

Scene auto selector  40
Scene mode 39, 40
Self-timer 59
Self-timer lamp 60
Sequence display options 80, 54
Setup menu 94
Shooting 26, 28, 50
Shooting info 10
Shooting menu 36, 30
Shooting mode 9, 24
Shutter sound 71
Shutter speed 28
Shutter-release button 4, 5, 28
Single AF 38, 91, 42, 59
Skin softening 80, 14
Slide show 80, 46
Slow sync 57
Small picture 80, 18
Smile timer 61
Smile timer continuous 61
Snow  46
Sound settings 95, 71
Speaker 2
Special effect menu 53
Special Effects Mode 53
Sports  45
SSCN 84
Strap 12
Subject tracking 37, 38, 40



Sunset  46

I

Target finding AF 37, 39

Thumbnail display 31

Time difference 94, 63

Time zone 94, 61, 63



Time zone and date 22, 94, 61

Tripod socket 3, 17

TV 81, 21

TV settings 95, 74

U

USB cable 81, 84, 24, 85

USB/audio/video output connector 81,
84, 23

V

Vibration reduction 94, 67

Video mode 74

ViewNX 2 82, 83

Voice memo 80, 50

Volume 92, 50

W

WAV 84

Welcome screen 94, 60

White balance 37, 30

Z

Zoom control 4, 5, 27

Zoom in 27

Zoom out 27



A series of horizontal dashed lines spanning the width of the page, intended for handwriting practice.

Nikon

No reproduction in any form of this manual, in whole or in part (except for brief quotation in critical articles or reviews), may be made without written authorization from NIKON CORPORATION.



NIKON CORPORATION

© 2011 Nikon Corporation

CT1G02(11)
6MM10911-02