

Nikon

DIGITAL CAMERA

COOLPIX S9100

User's Manual

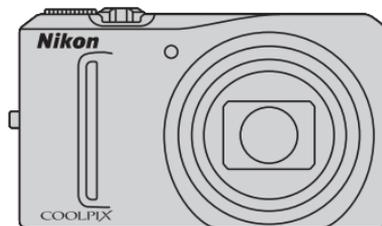

En

Trademark Information

- Microsoft, Windows and Windows Vista are either registered trademarks or trademarks of Microsoft Corporation in the United States and/or other countries.
- Macintosh, Mac OS, and QuickTime are trademarks of Apple Inc., registered in the U.S. and other countries. The iFrame logo and the iFrame symbol are trademarks of Apple Inc.
- Adobe and Acrobat are registered trademarks of Adobe Systems Inc.
- SDXC, SDHC and SD Logos are trademarks of SD-3C, LLC.
- PictBridge is a trademark.
- HDMI, **HDMI** logo and High-Definition Multimedia Interface are trademarks or registered trademarks of HDMI Licensing LLC.
- All other trade names mentioned in this manual or the other documentation provided with your Nikon product are trademarks or registered trademarks of their respective holders.

AVC Patent Portfolio License

This product is licensed under the AVC Patent Portfolio License for the personal and non-commercial use of a consumer to (i) encode video in compliance with the AVC standard ("AVC video") and/or (ii) decode AVC video that was encoded by a consumer engaged in a personal and non-commercial activity and/or was obtained from a video provider licensed to provide AVC video. No license is granted or shall be implied for any other use. Additional information may be obtained from MPEG LA, L.L.C.

See <http://www.mpegla.com>.

Introduction	
First Steps	
Basic Photography and Playback: 📷 (Auto) Mode	
More on Shooting	
More on Playback	
Editing Images	
Movie Recording and Playback	
Connecting to Televisions, Computers and Printers	
Basic Camera Setup	
Caring for the Camera	
Technical Notes and Index	

For Your Safety

To prevent damage to your Nikon product or injury to yourself or to others, read the following safety precautions in their entirety before using this equipment. Keep these safety instructions where all those who use the product will read them.



This icon marks warnings, information that should be read before using this Nikon product, to prevent possible injury.

WARNINGS

Turn off in the event of malfunction

Should you notice smoke or an unusual smell coming from the camera or Charging AC Adapter, unplug the Charging AC Adapter and remove the battery immediately, taking care to avoid burns. Continued operation could result in injury. After removing or disconnecting the power source, take the equipment to a Nikon-authorized service representative for inspection.

Do not disassemble

Touching the internal parts of the camera or Charging AC Adapter could result in injury. Repairs should be performed only by qualified technicians. Should the camera or Charging AC Adapter break open as the result of a fall or other accident, take the product to a Nikon-authorized service representative for inspection, after unplugging the product and/or removing the battery.

Do not use the camera or Charging AC Adapter in the presence of flammable gas

Do not use electronic equipment in the presence of flammable gas, as this could result in explosion or fire.

Handle the camera strap with care

Never place the strap around the neck of an infant or child.

Keep out of reach of children

Particular care should be taken to prevent infants from putting the battery or other small parts into their mouths.

Observe caution when handling the battery

The battery may leak, overheat, or explode if improperly handled.

Observe the following precautions when handling the battery for use in this product:

- Before replacing the battery, turn the product off. If you are using the Charging AC Adapter/AC adapter, be sure it is unplugged.
- Use only a Rechargeable Li-ion Battery EN-EL12 (supplied). Charge the battery by using a camera that supports battery charging or by using a Battery Charger MH-65 (available separately). To charge the battery with the camera, use either Charging AC Adapter EH-69P (supplied) or the **Charge by computer** function.
- When inserting the battery, do not attempt to insert it upside down or backwards.
- Do not short or disassemble the battery or attempt to remove or break the battery insulation or casing.
- Do not expose the battery to flame or to excessive heat.
- Do not immerse in or expose to water.
- Replace the terminal cover when transporting the battery. Do not transport or store with metal objects such as necklaces or hairpins.
- The battery is prone to leakage when fully discharged. To avoid damage to the product, be sure to remove the battery when no charge remains.
- Discontinue use immediately should you notice any change in the battery, such as discoloration or deformation.

- If liquid from the damaged battery comes in contact with clothing or skin, rinse immediately with plenty of water.

Observe the following precautions when handling the Charging AC Adapter

- Keep dry. Failure to observe this precaution could result in fire or electric shock.
- Dust on or near the metal parts of the plug should be removed with a dry cloth. Continued use could result in fire.
- Do not handle the plug or go near the Charging AC Adapter during lightning storms. Failure to observe this precaution could result in electric shock.
- Do not damage, modify, forcibly tug or bend the USB cable, place it under heavy objects, or expose it to heat or flames. Should the insulation be damaged and the wires become exposed, take it to a Nikon-authorized service representative for inspection. Failure to observe these precautions could result in fire or electric shock.
- Do not handle the plug or Charging AC Adapter with wet hands. Failure to observe this precaution could result in electric shock.
- Do not use with travel converters or adapters designed to convert from one voltage to another or with DC-to-AC inverters. Failure to observe this precaution could damage the product or cause overheating or fire.

⚠ Use appropriate cables

When connecting cables to the input and output jacks, use only the cables provided or sold by Nikon for the purpose, to maintain compliance with product regulations.

⚠ Handle moving parts with care

Be careful that your fingers or other objects are not pinched by the lens cover or other moving parts.

⚠ CD-ROMs

The CD-ROMs supplied with this device should not be played back on audio CD equipment. Playing CD-ROMs on an audio CD player could cause hearing loss or damage the equipment.

⚠ Observe caution when using the flash

Using the flash close to your subject's eyes could cause temporary visual impairment. Particular care should be observed if photographing infants, when the flash should be no less than 1 m (3 ft. 4 in.) from the subject.

⚠ Do not operate the flash with the flash window touching a person or object

Failure to observe this precaution could result in burns or fire.

⚠ Avoid contact with liquid crystal

Should the monitor break, care should be taken to avoid injury caused by broken glass and to prevent liquid crystal from the monitor touching the skin or entering the eyes or mouth.

⚠ Turn the power off when using inside an airplane or the hospital

Turn the power off while inside the airplane during take off or landing. Follow the instructions of the hospital when using while in a hospital. The electromagnetic waves given out by this camera may disrupt the electronic systems of the airplane or the instruments of the hospital.

Notices

Notices for Customers in the U.S.A.

IMPORTANT SAFETY INSTRUCTIONS - SAVE THESE INSTRUCTIONS.

DANGER - TO REDUCE THE RISK OF FIRE OR ELECTRIC SHOCK, CAREFULLY FOLLOW THESE INSTRUCTIONS

For connection to a supply not in the U.S.A., use an attachment plug adapter of the proper configuration for the power outlet if needed.

The power supply unit is intended to be correctly orientated in a vertical or floor mount position.

Federal Communications Commission (FCC) Radio Frequency Interference Statement

This equipment has been tested and found to comply with the limits for a Class B digital device, pursuant to Part 15 of the FCC rules. These limits are designed to provide reasonable protection against harmful interference in a residential installation. This equipment generates, uses, and can radiate radio frequency energy and, if not installed and used in accordance with the instructions, may cause harmful interference to radio communications. However, there is no guarantee that interference will not occur in a particular installation. If this

equipment does cause harmful interference to radio or television reception, which can be determined by turning the equipment off and on, the user is encouraged to try to correct the interference by one or more of the following measures:

- Reorient or relocate the receiving antenna.
- Increase the separation between the equipment and receiver.
- Connect the equipment into an outlet on a circuit different from that to which the receiver is connected.
- Consult the dealer or an experienced radio/television technician for help.



Nikon

COOLPIX S9100

CAUTIONS

Modifications

The FCC requires the user to be notified that any changes or modifications made to this device that are not expressly approved by Nikon Corporation may void the user's authority to operate the equipment.

Interface Cables

Use the interface cables sold or provided by Nikon for your equipment. Using other interface cables may exceed the limits of Class B Part 15 of the FCC rules.

Notice for customers in the State of California

WARNING

Handling the cord on this product will expose you to lead, a chemical known to the State of California to cause birth defects or other reproductive harm.

Wash hands after handling.

Nikon Inc.,

1300 Walt Whitman Road

Melville, New York 11747-3064

USA

Tel: 631-547-4200

Notice for customers in Canada

CAUTION

This Class B digital apparatus complies with Canadian ICES-003.

ATTENTION

Cet appareil numérique de la classe B est conforme à la norme NMB-003 du Canada.

Notices for customers in Europe

CAUTIONS

RISK OF EXPLOSION IF BATTERY IS REPLACED BY AN INCORRECT TYPE.

DISPOSE OF USED BATTERIES ACCORDING TO THE INSTRUCTIONS.

This symbol indicates that this product is to be collected separately.



The following apply only to users in European countries:

- This product is designated for separate collection at an appropriate collection point. Do not dispose of as household waste.
- For more information, contact the retailer or the local authorities in charge of waste management.

This symbol on the battery indicates that the battery is to be collected separately.



The following apply only to users in European countries:

- All batteries, whether marked with this symbol or not, are designated for separate collection at an appropriate collection point. Do not dispose of as household waste.
- For more information, contact the retailer or the local authorities in charge of waste management.

Table of Contents

For Your Safety	ii
WARNINGS	ii
Notices	v
<hr/>	
Introduction	1
About This Manual	1
Information and Precautions	2
Parts of the Camera	4
The Camera Body	4
The Monitor	6
Basic Operations	9
Raising and Lowering the Flash (⚡🔒 Flash Pop-up Control)	9
The Shutter-release Button	9
Mode Dial	10
The  (Playback) Button	10
The  (Movie-record) Button	10
The Rotary Multi Selector	11
Using Camera Menus	12
Switching Between the Tabs on Menu Screens	13
Attaching the Camera Strap	13
<hr/>	
First Steps	14
Inserting the Battery	14
Removing the Battery	15
Charging the Battery	16
Turning On and Off the Camera	19
Setting Display Language, Date, and Time	20
Inserting Memory Cards	22
Removing Memory Cards	22
<hr/>	
Basic Photography and Playback:  (Auto) Mode	24
Step 1 Turn the Camera On and Select  (Auto) Mode	24
Indicators Displayed in  (Auto) Mode	25
Step 2 Frame a Picture	26
Using the Zoom	27
Step 3 Focus and Shoot	28
Step 4 Playing Back and Deleting Images	30
Playing Back Images (Playback Mode)	30
Deleting Unwanted Images	31
Using the Flash	32
Setting the Flash Mode	33
Taking Pictures with the Self-timer	35
Taking Pictures with the Smile Timer	37
Macro Mode	39

Table of Contents

Adjusting Brightness (Exposure Compensation), Vividness, and Hue	40
Operating the Creative Slider	41
Adjusting Exposure Compensation	44
More on Shooting	45
Selecting a Shooting Mode (Mode Dial)	45
Changing  (Auto) Mode Settings (Shooting Menu)	46
Image Mode (Image Quality/Image Size)	47
White Balance (Adjusting Hue)	49
Metering	51
ISO Sensitivity	52
AF Area Mode	53
Autofocus Mode	60
Shooting Suited to Scenes (Scene Mode)	61
Shooting in the Scene Mode Selected by the Camera (Scene Auto Selector)	62
Choosing a Scene and Shooting (Scene Mode Types and Characteristics)	64
Shooting with Easy Panorama	75
Playing Images Captured with Easy Panorama	77
Shooting with Panorama Assist	78
Burst Shooting (Continuous Shooting Mode)	80
Changing Continuous Shooting Mode Settings	82
Applying Effects When Shooting (Special Effects Mode)	85
Camera Settings that Cannot Be Applied Simultaneously	87
More on Playback	89
Operations in Full-frame Playback Mode	89
Displaying the Histogram and Shooting Information	91
Playing Images Captured Using Continuous Shooting Mode (Sequence)	92
Viewing Multiple Images: Thumbnail Playback	94
Calendar Display	96
Taking a Closer Look: Playback Zoom	97
Playing Back Images by Category	99
Sorting Favorite Images (Favorite Pictures Mode)	101
Adding Images to an Album	101
Viewing Images in an Album	103
Removing Images From an Album	104
Using Favorite Pictures Mode	105
Favorite Pictures Menu	105
Changing the Album Icons	106
Finding Images in Auto Sort Mode	109
Viewing Images in Auto Sort Mode	109
Operations in Auto Sort Mode	112
Auto Sort Menu	112

Viewing Images by Date (List by Date)	113
Viewing Images in List by Date Mode	113
Operations in List by Date Mode	114
List by Date Menu	114
Playback Options: Playback Menu	115
 Print Order (Creating a DPOF Print Order).....	117
 Slide Show	121
 Protect.....	122
 Rotate Image	124
 Voice Memo	125
 Copy (Copy Between Internal Memory and Memory Card)	127
 Sequence Display Options.....	129
 Choose Key Picture	129
<hr/>	
Editing Images	130
Editing Functions	130
Image Editing	132
 Quick Retouch: Enhancing Contrast and Saturation	132
 D-Lighting: Enhancing Brightness and Contrast.....	133
 Skin Softening: Softening Skin Tones	134
 Filter Effects (Digital Filter).....	135
 Frame (Adding Frames to Images)	137
 Small Picture: Decreasing Image Size.....	138
 Crop: Creating a Cropped Copy	139
<hr/>	
Movie Recording and Playback	140
Recording Movies	140
Capturing Still Images While Recording Movies	142
Recording Movies in Slow Motion and Fast Motion (HS Movie).....	143
Changing Movie Recording Settings	146
Movie Options	148
Open with HS Footage.....	150
Autofocus Mode.....	150
Electronic VR.....	151
Wind Noise Reduction.....	151
Movie Playback	152
Deleting Movies.....	152
Editing Movies	153
<hr/>	
Connecting to Televisions, Computers and Printers	155
Connecting to a TV.....	155

Table of Contents

Connecting to a Computer	157
Before Connecting the Camera.....	157
Transferring Images from a Camera to a Computer.....	158
Charging While Connecting to a Computer.....	162
Connecting to a Printer	163
Connecting the Camera to a Printer.....	164
Printing Images One at a Time.....	165
Printing Multiple Images.....	166
<hr/>	
Basic Camera Setup	169
Setup Menu	169
Welcome Screen.....	171
Time Zone and Date.....	172
Monitor Settings.....	175
Print Date (Imprinting Date and Time).....	177
Vibration Reduction.....	178
Motion Detection.....	180
AF Assist.....	181
Digital Zoom.....	182
Sound Settings.....	183
Auto Off.....	184
Format Memory/Format Card.....	185
Language.....	186
TV Settings.....	186
Charge by Computer.....	187
Blink Warning.....	188
Reset All.....	190
Firmware Version.....	193
<hr/>	
Caring for the Camera	194
Maximizing Camera Life and Performance	194
Cleaning.....	196
Storage.....	196
<hr/>	
Technical Notes and Index	197
Optional Accessories	197
Approved Memory Cards.....	198
File and Folder Names	199
Error Messages	200
Troubleshooting	205
Specifications	212
Supported Standards.....	215
Index	216

About This Manual

Thank you for your purchase of a Nikon COOLPIX S9100 digital camera. This manual was written to help you enjoy taking pictures with your Nikon digital camera. Read this manual thoroughly before use, and keep it where all those who use the product will read it.

Symbols and Conventions

To make it easier to find the information you need, the following symbols and conventions are used:



This icon marks cautions, information that should be read before use, to prevent damage to the camera.



This icon marks tips, additional information that may be helpful when using the camera.



This icon marks notes, information that should be read before using the camera.



This icon indicates that more information is available elsewhere in this manual.

Notations

- Secure Digital (SD) memory card, SDHC memory card, and SDXC memory card are referred to as “memory card.”
- The setting at the time of purchase is referred to as the “default setting.”
- The names of menu items displayed in the camera monitor, and the names of buttons or messages displayed on a computer monitor appear in bold.

Screen Samples

In this manual, images are sometimes omitted from monitor display samples so that monitor indicators can be more clearly shown.

Illustrations and Screen Display

Illustrations and text displays shown in this manual may differ from actual display.

Internal Memory and Memory Cards

Pictures taken with this camera can be stored in the camera’s internal memory or on removable memory cards. If a memory card is inserted, all new pictures will be stored on the memory card and delete, playback, and format operations will apply only to the pictures on the memory card. The memory card must be removed before the internal memory can be formatted or accessed for picture storage, deletion, or viewing.

Information and Precautions

Life-Long Learning

As part of Nikon's "Life-Long Learning" commitment to ongoing product support and education, continually updated information is available online at the following sites:

- For users in the U.S.A.: <http://www.nikonusa.com/>
- For users in Europe and Africa: <http://www.europe-nikon.com/support/>
- For users in Asia, Oceania, and the Middle East: <http://www.nikon-asia.com/>

Visit these sites to keep up-to-date with the latest product information, tips, answers to frequently asked questions (FAQs), and general advice on digital imaging and photography. Additional information may be available from the Nikon representative in your area. Visit the site below for contact information:

<http://imaging.nikon.com/>

Use Only Nikon Brand Electronic Accessories

Nikon COOLPIX cameras are designed to the highest standards and include complex electronic circuitry. Only Nikon brand electronic accessories (including battery charger, batteries, Charging AC Adapter, and AC adapters) certified by Nikon specifically for use with this Nikon digital camera are engineered and proven to operate within the operational and safety requirements of this electronic circuitry.

THE USE OF NON-NIKON ELECTRONIC ACCESSORIES COULD DAMAGE THE CAMERA AND MAY VOID YOUR NIKON WARRANTY.

The use of third-party rechargeable Li-ion batteries not bearing the Nikon holographic seal could interfere with normal operation of the camera or result in the batteries overheating, igniting, rupturing, or leaking.

For more information about Nikon brand accessories, contact a local authorized Nikon dealer.

Holographic seal: Identifies this device as an authentic Nikon product.

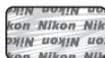

Before Taking Important Pictures

Before taking pictures on important occasions (such as at weddings or before taking the camera on a trip), take a test shot to ensure that the camera is functioning normally. Nikon will not be held liable for damages or lost profits that may result from product malfunction.

About the Manuals

- No part of the manuals included with this product may be reproduced, transmitted, transcribed, stored in a retrieval system, or translated into any language in any form, by any means, without Nikon's prior written permission.
- Nikon reserves the right to change the specifications of the hardware and software described in these manuals at any time and without prior notice.
- Nikon will not be held liable for any damages resulting from the use of this product.
- While every effort was made to ensure that the information in these manuals is accurate and complete, we would appreciate it were you to bring any errors or omissions to the attention of the Nikon representative in your area (address provided separately).

Notice Concerning Prohibition of Copying or Reproduction

Note that simply being in possession of material that was digitally copied or reproduced by means of a scanner, digital camera or other device may be punishable by law.

• Items prohibited by law from being copied or reproduced

Do not copy or reproduce paper money, coins, securities, government bonds or local government bonds, even if such copies or reproductions are stamped "Sample." The copying or reproduction of paper money, coins, or securities which are circulated in a foreign country is prohibited. Unless the prior permission of the government was obtained, the copying or reproduction of unused postage stamps or post cards issued by the government is prohibited.

The copying or reproduction of stamps issued by the government and of certified documents stipulated by law is prohibited.

• Cautions on certain copies and reproductions

The government has issued cautions on copies or reproductions of securities issued by private companies (shares, bills, checks, gift certificates, etc.), commuter passes, or coupon tickets, except when a minimum of necessary copies are to be provided for business use by a company. Also, do not copy or reproduce passports issued by the government, licenses issued by public agencies and private groups, ID cards and tickets, such as passes and meal coupons.

• Comply with copyright notices

The copying or reproduction of copyrighted creative works such as books, music, paintings, woodcut prints, maps, drawings, movies, and photographs is governed by national and international copyright laws. Do not use this product for the purpose of making illegal copies or to infringe copyright laws.

Disposing of Data Storage Devices

Please note that deleting images or formatting data storage devices such as memory cards or built-in camera memory does not completely erase the original image data. Deleted files can sometimes be recovered from discarded storage devices using commercially available software, potentially resulting in the malicious use of personal image data. Ensuring the privacy of such data is the user's responsibility.

Before discarding a data storage device or transferring ownership to another person, erase all data using commercial deletion software, or format the device and then completely refill it with images containing no private information (for example, pictures of empty sky). Be sure to also replace any pictures selected for the **Select an image** option in the **Welcome screen** setting (📖 171). Care should be taken to avoid injury or damage to property when physically destroying data storage devices.

Parts of the Camera

The Camera Body

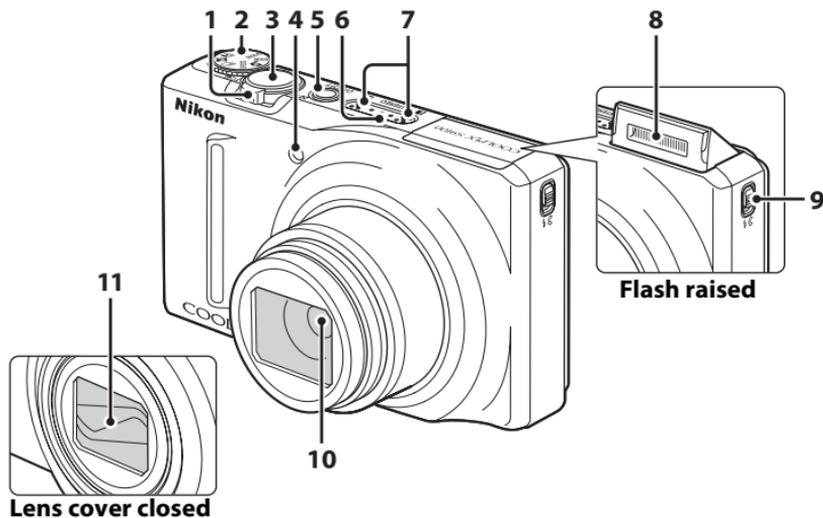

1	Zoom control.....27
	W : wide.....27
	T : tele.....27
	: thumbnail playback.....94, 96
	: playback zoom.....97
	: help.....61
2	Mode dial.....45
3	Shutter-release button.....9, 28
4	Self-timer lamp.....35
	AF-assist illuminator.....181

5	Power switch/power-on lamp19, 184
6	Speaker.....126, 152
7	Microphone (stereo).....125, 140
8	Flash.....32
9	(flash pop-up) control.....32
10	Lens.....196, 212
11	Lens cover

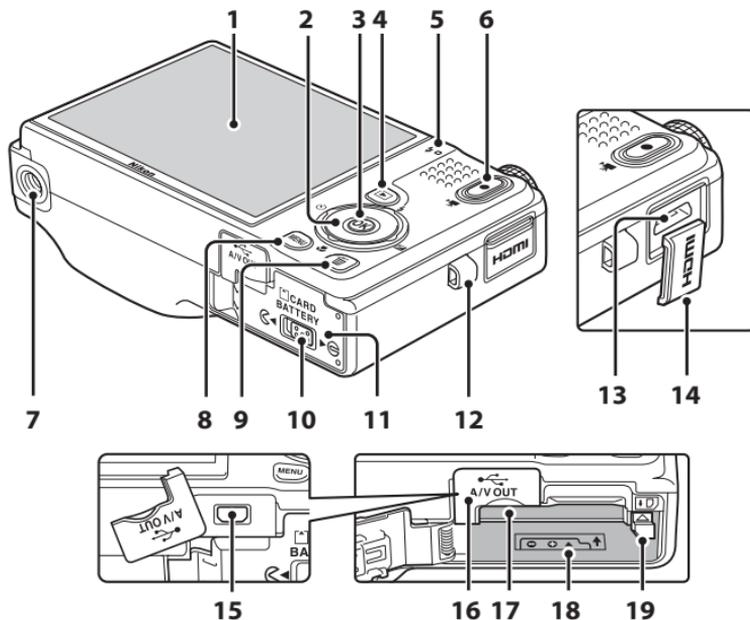

1	Monitor	6, 25	11	Battery-chamber/ memory card slot cover.....	14, 22
2	Rotary multi selector.....	11	12	Eyelet for camera strap.....	13
3	OK (apply selection) button.....	11	13	HDMI mini connector.....	155
4	▶ (playback) button.....	10, 30, 89	14	HDMI connector cover	155
5	Charge lamp	17, 162	15	USB/audio/video output connector	16, 155, 158, 164
6	Flash lamp	34	16	Connector cover.....	16, 155, 158, 164
7	Tripod socket.....	213	17	Memory card slot	22
8	MENU button.....	12, 46, 99, 116, 146, 170	18	Battery chamber	14
9	🗑 (delete) button.....	31, 126, 152	19	Battery latch	14, 15
10	Cover latch.....	14, 22			

The Monitor

The following indicators may appear in the monitor during shooting and playback (actual display varies with current camera settings).

The indicators that appear in the monitor during shooting and playback disappear after a few seconds (📖 175).

Shooting

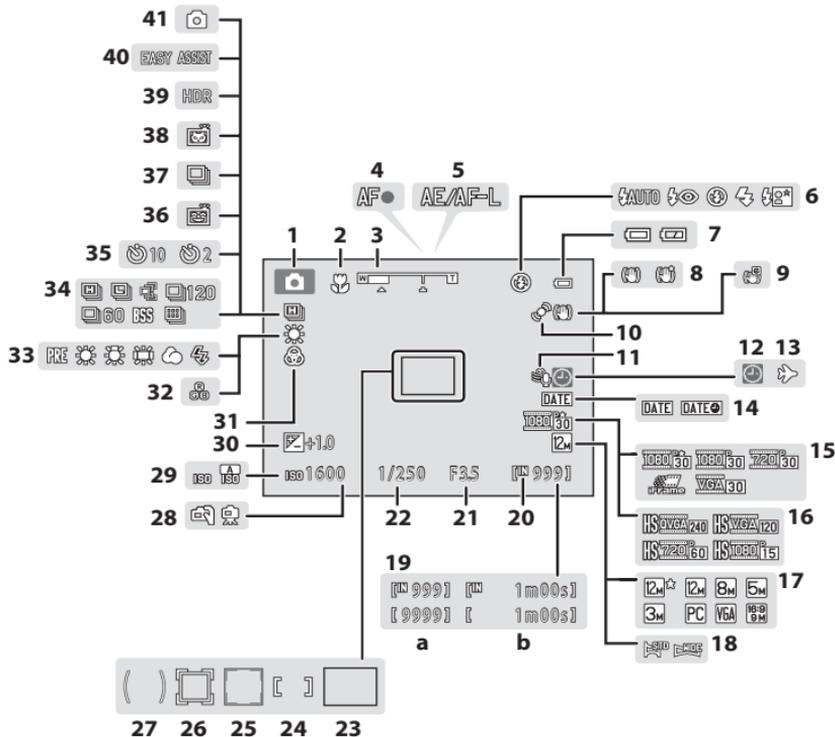

1	Shooting mode*.....	24, 58, 61, 80	21	Aperture.....	28
2	Macro mode	39	22	Shutter speed.....	28
3	Zoom indicator	27, 39	23	Focus area (auto).....	28, 53
4	Focus indicator.....	28	24	Focus area (for manual or center)	53
5	AE/AF-L indicator.....	79	25	Focus area (face detection, pet detection)	28, 53
6	Flash mode	32	26	Focus area (subject tracking).....	58
7	Battery level indicator	24	27	Center-weighted metering area	51
8	Vibration reduction icon	25, 178	28	Hand-held/tripod.....	64, 65
9	Electronic vibration reduction icon	140, 146	29	ISO sensitivity.....	34, 52
10	Motion detection icon.....	180	30	Exposure compensation value.....	43, 44
11	Wind noise reduction.....	151	31	Vividness.....	43
12	"Date not set" indicator.....	172, 200	32	Hue.....	43
13	Travel destination icon.....	172	33	White balance	49
14	Print date.....	177	34	Continuous shooting mode	80
15	Movie options (normal speed movies)	148	35	Self-timer	35
16	Movie options (HS movies).....	148	36	Smile timer	37
17	Image mode	47	37	Continuous (pet portrait mode).....	74
18	Easy panorama	75	38	Pet portrait auto release	74
19	(a) Number of exposures remaining (still images).....	24	39	Backlighting (HDR)	66
	(b) Movie length.....	140, 149	40	Panorama.....	73
20	Internal memory indicator	25	41	Still image capture (movie recording)	142

* The icon displayed varies with the shooting mode.

Playback

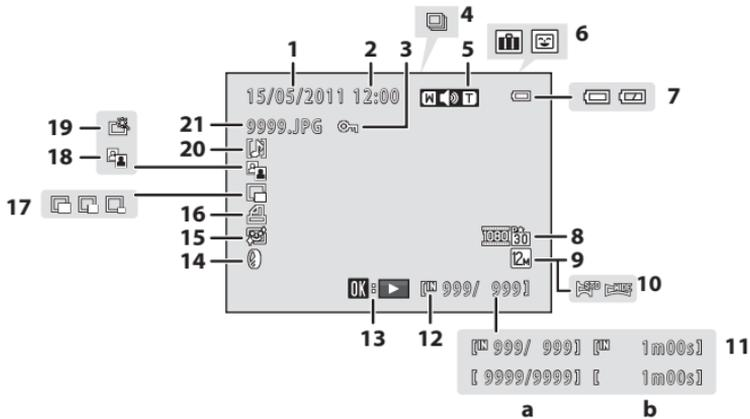

1	Date of recording	20	12	Internal memory indicator	30
2	Time of recording	20	13	Easy panorama playback guide	77
3	Protect icon	122	14	Sequence playback guide	92
4	Sequence display	92, 95	15	Movie playback guide	152
5	Volume indicator	126, 152	16	Filter effects icon	135
6	Album icon in favorite pictures mode ¹ Category icon in auto sort mode ¹	103 109	17	Skin softening icon	134
7	Battery level indicator	24	18	Print order icon	117
8	Movie options ²	148	19	Small picture icon	138
9	Image mode ²	47, 142	20	D-Lighting icon	133
10	Easy panorama	77	21	Quick retouch icon	132
11	(a) Current frame number/ total number of frames	30		Voice memo indicator	126
	(b) Movie length	152		File number and type	199

¹ The icon for the selected album or the selected category in auto sort mode in playback mode is displayed.

² The icon displayed varies with the setting that was set at the time of shooting.

Basic Operations

Raising and Lowering the Flash (⚡🔒 Flash Pop-up Control)

Slide the ⚡🔒 (flash pop-up) control (①) to make the flash pop up (②).

- See “Using the Flash” (📖 32) for more information on setting the flash.
- If the flash will not be used, gently lower the flash until it clicks into place.

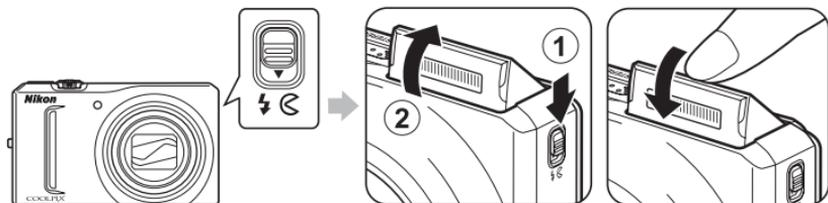

The Shutter-release Button

The camera features a two-stage shutter-release button. To set focus and exposure, press the shutter-release button halfway, stopping when you feel resistance. When the shutter-release button is pressed halfway, focus and exposure (shutter speed and aperture value) are set. Focus and exposure remain locked while the shutter-release button is pressed halfway.

While the shutter-release button is held in this position, release the shutter and take a picture by pressing the shutter-release button the rest of the way down. Do not use force when pressing the shutter-release button, as this may result in camera shake and blurred images.

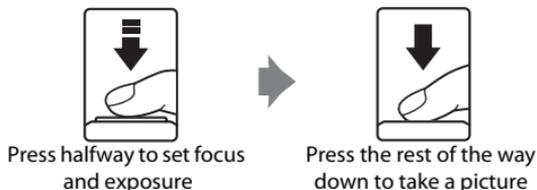

Mode Dial

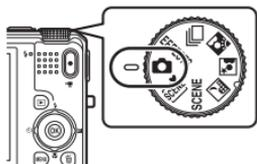

Rotate the mode dial to the desired icon to switch to the corresponding shooting mode (📖 45).

The ▶ (Playback) Button

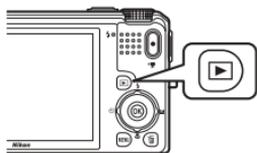

- Press the ▶ button in shooting mode to enter playback mode.
- When the camera is in shooting mode, press the ▶ button to switch to playback mode.
- When the camera is off, holding down the ▶ button will turn the camera on in playback mode.

The ● (▶🎥 Movie-record) Button

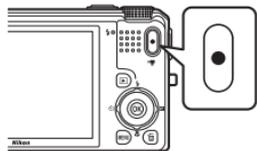

- Press the ● (▶🎥 movie-record) button in shooting mode to start movie recording (📖 140). Press the ● (▶🎥 movie-record) button again to stop movie recording.
- Press the ● (▶🎥 movie-record) button in playback mode to enter shooting mode.

The Rotary Multi Selector

Rotate the rotary multi selector, press its upper (▲), lower (▼), left (◀), or right side (▶), or press the **OK** button.

Shooting

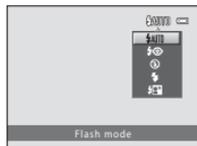
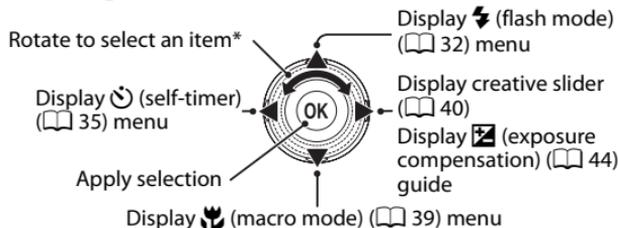

* Items can also be selected by pressing the rotary multi selector up or down.

Playback

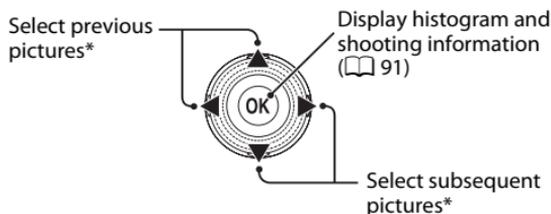

* Previous or subsequent pictures can also be selected by rotating the rotary multi selector.

Menu Screen

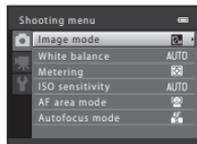
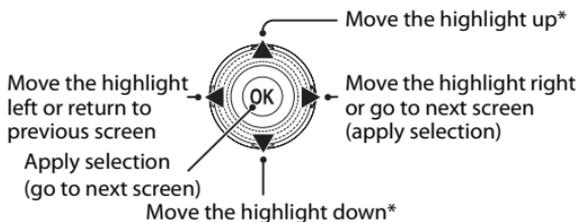

* The highlight can also be moved by rotating the rotary multi selector.

Using Camera Menus

Press the **MENU** button (📖 5) to display the menu for the selected mode.

Use the rotary multi selector (📖 11) to navigate the menus.

Tab for the menus available in the current shooting mode/
tab for playback mode menu

Tab for movie menu (during shooting mode)/playback menu (during playback mode)

Tab for displaying the setup menu

△ is displayed when previous menu items are available.

▽ is displayed when there are one or more menu items to follow.

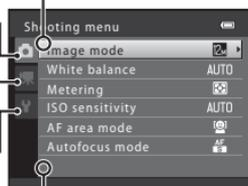

1 Press the **MENU** button.

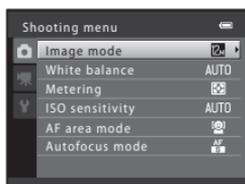
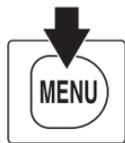

2 Press the rotary multi selector ▲ or ▼ to choose an item, and then press ► or the **OK** button.

Items can also be chosen by rotating the rotary multi selector (📖 11).

To change tabs, press ◀ (📖 13).

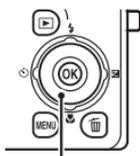

Rotary multi selector

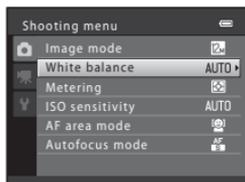

3 Press ▲ or ▼ to choose an item and press the **OK** button.

The setting is applied.

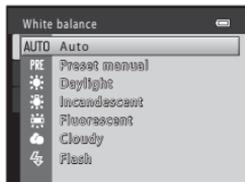

4 When setting is finished, press the **MENU** button.

The camera exits the menu display.

Switching Between the Tabs on Menu Screens

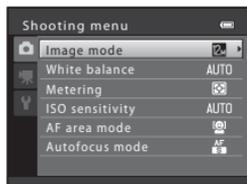

Press the rotary multi selector ◀ to highlight the tab



Press the rotary multi selector ▲ or ▼ to select a tab, and press either the OK button or ▶

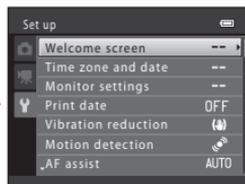

The selected menu is displayed

Attaching the Camera Strap

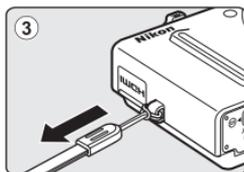
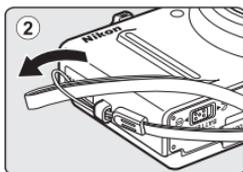
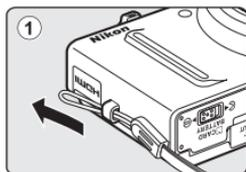

Inserting the Battery

Insert a Rechargeable Li-ion Battery EN-EL12 (supplied) into the camera.

- Charge the battery before the first use or when the battery is running low (📖 16).

- 1 Open the battery-chamber/memory card slot cover.

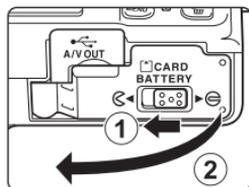

- 2 Insert the battery.

Use the battery to lift the orange battery latch in the direction indicated by the arrow (1) and fully insert the battery (2).

When the battery is fully inserted, the battery latch will lock it in place.

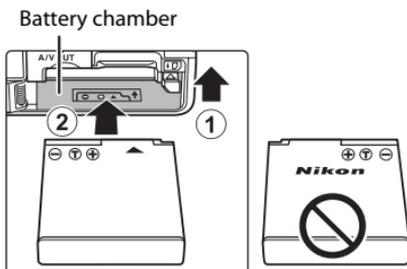

✔ Inserting the Battery

Inserting the battery upside down or backwards could damage the camera. Be sure to check that the battery is in the correct orientation.

- 3 Close the battery-chamber/memory card slot cover.

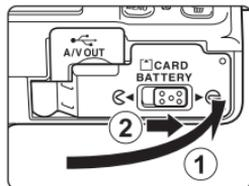

Removing the Battery

Turn the camera off (📖 19) and be sure that the power-on lamp and the monitor have turned off before opening the battery-chamber/memory card slot cover.

To eject the battery, open the battery-chamber/memory card slot cover and slide the orange battery latch in the direction indicated by the arrow (①). The battery can then be removed by hand (②).

- The camera, battery, or memory card may be hot immediately after using the camera. Observe caution when removing the battery or memory card.

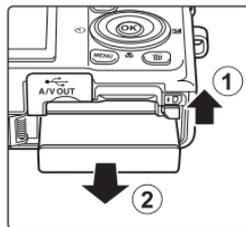

✓ Notes on the Battery

- Be sure to read and follow the warnings for the battery on page iii and the section, “The Battery” (📖 195), before use.
- If the battery will not be used for an extended period, recharge it at least once every six months and run it flat before returning it to storage.

Charging the Battery

Charge the supplied Rechargeable Li-ion Battery EN-EL12 inserted into the camera, by connecting the supplied Charging AC Adapter EH-69P to the camera via the supplied USB Cable UC-E6, and then plugging the Charging AC Adapter into an electrical outlet.

First Steps

1 Prepare the Charging AC Adapter EH-69P.

If a plug adapter* is included, attach the plug adapter to the plug on the Charging AC Adapter. Push the plug adapter firmly until it is securely held in place. Once the two are connected, attempting to forcibly remove the plug adapter could damage the product.

* The shape of the plug adapter varies according to the country or region in which the camera was purchased.
The Charging AC Adapter comes with the plug adapter attached in Argentina and Korea.

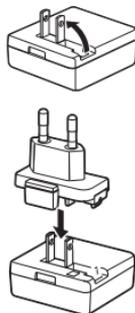

2 Insert the battery (14).

Do not turn the camera on.

3 Use the supplied USB cable to connect the Charging AC Adapter to the camera.

Be sure that connectors are properly oriented. Do not attempt to insert connectors at an angle, and do not use force when connecting or disconnecting the USB cable.

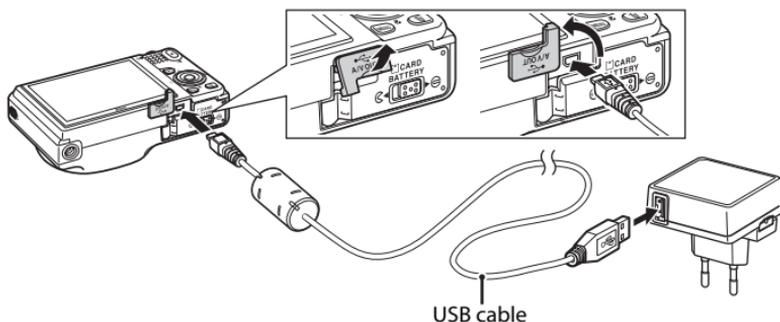

4 Plug the Charging AC Adapter into an electrical outlet.

The charge lamp slowly blinks green to indicate that the battery is charging.

About 3 hours and 50 minutes are required to charge a fully exhausted battery.

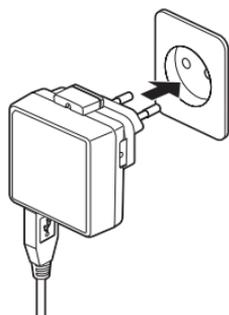

The following chart explains charge lamp status when the camera is plugged into the electrical outlet.

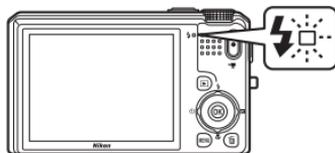

Charge lamp	Description
Blinks slowly (green)	Battery charging.
Off	Battery not charging. When charging is complete, the charge lamp stops blinking green and turns off.
Flickers (green)	<ul style="list-style-type: none"> The ambient temperature is not suited to charging. Charge the battery indoors with an ambient temperature of 5°C to 35°C (41°F to 95°F). The USB cable or Charging AC Adapter is not properly connected, or there is a problem with the battery. Disconnect the USB cable or unplug the Charging AC Adapter and correctly connect it again, or change the battery.

5 Disconnect the Charging AC Adapter from the electrical outlet and then disconnect the USB cable.

Notes on Charging AC Adapter

- The Charging AC Adapter EH-69P is for use only with compatible devices. Do not use with another make or model of device.
- Be sure to read and follow the warnings for the Charging AC Adapter on page iii and the section, “The Battery” (📖 195), before use.
- The EH-69P is compatible with AC 100-240 V, 50/60 Hz electrical outlets. When using in other countries, use a plug adapter (commercially available) as necessary. For more information about plug adapters, consult your travel agency.
- The Charging AC Adapter EH-69P is for charging the battery inserted into the camera. When the camera is connected to an electrical outlet with the Charging AC Adapter EH-69P, the camera cannot be turned on.
- Do not, under any circumstances, use another make or model of USB-AC adapter other than Charging AC Adapter EH-69P. Failure to observe this precaution could result in overheating or in damage to the camera.

AC Power Source

- If the AC Adapter EH-62F (available separately; 📖 197) is used, power is supplied to the camera from an electrical outlet and taking pictures and playing back images are available with this camera.
- Do not, under any circumstances, use another make or model of AC adapter other than EH-62F. Failure to observe this precaution could result in overheating or in damage to the camera.

Charging Using Computer or Battery Charger

- Connecting the COOLPIX S9100 to a computer also charges the Rechargeable Li-ion Battery EN-EL12 (📖 157, 187).
- The EN-EL12 can be charged without using the camera by using the Battery Charger MH-65 (available separately; 📖 197).

Turning On and Off the Camera

Press the power switch to turn on the camera. The power-on lamp (green) will light, and then the monitor will turn on (the power-on lamp turns off when the monitor turns on). To turn off the camera, press the power switch again. When the camera is turned off, the power-on lamp and the monitor will turn off.

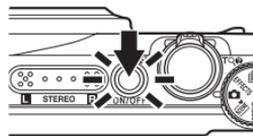

- If the camera is turned off, hold down the  button to turn the camera on in playback mode ( 30).

Power Saving Function (Auto Off)

If no operations are performed for a while, the monitor will turn off, the camera will enter standby mode, and the power-on lamp will blink. If no operations are performed for another three minutes, the camera will turn off automatically.

When the power-on lamp is blinking, the following operations will turn the monitor back on.

- Pressing the power switch, shutter-release button,  button, or  (movie-record) button
- Rotating the mode dial
- In shooting or playback mode, the camera will enter standby mode in about one minute (default setting).
- The time allowed to elapse before the camera enters standby mode can be changed from the **Auto off** option ( 184) in the setup menu ( 169).

Setting Display Language, Date, and Time

When the first time the camera is turned on, the language-selection screen and the date and time setting screen for the camera clock are displayed.

1 Press the power switch to turn on the camera.

The power-on lamp (green) will light, and then the monitor will turn on (the power-on lamp turns off when the monitor turns on).

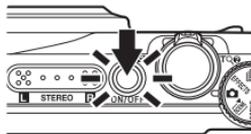

2 Press the rotary multi selector ▲ or ▼ to choose the desired language and press the OK button.

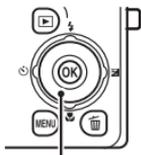

Rotary multi selector



3 Press ▲ or ▼ to choose Yes and press the OK button.

To cancel the setting the time zone and date, select **No**.



4 Press ◀ or ▶ to choose your home time zone (📖 174) and press the OK button.

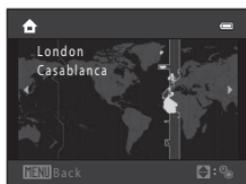

Daylight Saving Time

If daylight saving time is in effect, press ▲ to enable the daylight saving time function while setting the region in step 4.

When the daylight saving time function is enabled,  is displayed at the top of the monitor. Press ▼ to disable the daylight saving time function.

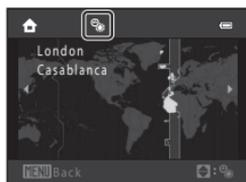

- 5** Press ▲ or ▼ to choose the date format and press the **OK** button.

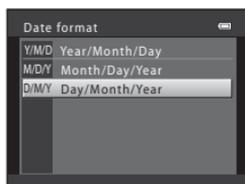

- 6** Press ▲, ◀, ▼, or ▶ to set the date and time, and press the **OK** button.

Choose an item: Press ▶ or ◀ (changes between **D**, **M**, **Y**, **hour**, and **minute**).

Edit the highlighted item: Rotate the rotary multi selector or press ▲ or ▼.

Apply the setting: Select the minute setting and press the **OK** button or ▶.

When settings are finished, the lens extends and the camera switches to shooting mode.

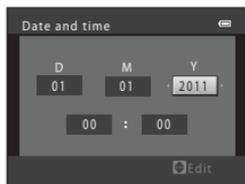

Print Date and Changing the Date and Time

- To imprint the date on images while taking pictures, enable print date from the **Print date** option (📖 177) in the setup menu (📖 169) after the date and time have been set.
- To change the camera's date and time setting, select **Time zone and date** (📖 172) in the setup menu (📖 169).

Inserting Memory Cards

Data is saved in the camera's internal memory (approximately 74 MB) or on removable Secure Digital (SD) memory cards (commercially available;  198).

If a memory card is inserted in the camera, data are automatically saved on the memory card and data saved to the memory card can be played back, deleted, or transferred. Remove the memory card to save data in the internal memory, or play back, delete, or transfer data from the internal memory.

- 1 Be sure that the power-on lamp and the monitor are off and open the battery-chamber/memory card slot cover.

Be sure to turn off the camera before opening the cover.

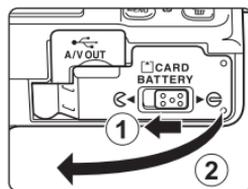

- 2 Insert the memory card.

Slide the memory card in until it clicks into place.

Inserting Memory Cards

Inserting the memory card upside down or backwards could damage the camera or the memory card. Be sure to check that the memory card is in the correct orientation.

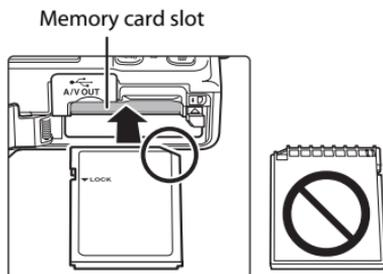

- 3 Close the battery-chamber/memory card slot cover.

Removing Memory Cards

Turn the camera off and be sure that the power-on lamp and the monitor have turned off before opening the battery-chamber/memory card slot cover.

Press the card in (1) to partially eject the card, then remove the card by hand while being careful not to remove the card at an angle (2).

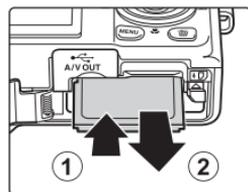

- The camera, battery, or memory card may be hot immediately after using the camera. Observe caution when removing the battery or memory card.

✓ Formatting Memory Cards

If the message on the right is displayed when the camera is turned on, the memory card must be formatted before use (📖 185). Note that **formatting permanently deletes all images and other data on the memory card**. Be sure to make copies of any images you wish to keep before formatting the memory card.

When formatting the memory card, use the rotary multi-selector to choose **Yes** and press the **OK** button. The confirmation dialog will be displayed. To start formatting, choose **Format** and press the **OK** button.



- Do not turn the camera off or open the battery-chamber/memory card slot cover until formatting is complete.
- Be sure to use this camera to format memory cards previously used in other devices the first time they are inserted into the COOLPIX S9100 (📖 185).

✓ Note on the Write Protect Switch

When memory card switch is in the lock position, data cannot be written to, or deleted from, the memory card. If the switch is in the lock position, unlock it by sliding the switch to the write position to save or delete images, or to format the memory card.

Write protect switch

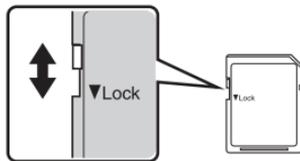

✓ Notes on Memory Cards

- Use only Secure Digital memory cards.
- Do not perform the following during formatting, while data is being written to or deleted from the memory card, or during data transfer to a computer. Failure to observe this precaution could result in the loss of data or in damage to the camera or memory card:
 - Remove the battery or memory card
 - Turn off the camera
 - Disconnect the AC adapter
- Do not format the memory card using a computer.
- Do not disassemble or modify.
- Do not drop, bend, or expose to water or strong physical shock.
- Do not touch the metal terminals with your fingers or metal objects.
- Do not affix labels or stickers to the memory card.
- Do not leave in direct sunlight, closed vehicles, or areas exposed to high temperatures.
- Do not expose to humidity, dust, or corrosive gases.

Step 1 Turn the Camera On and Select  (Auto) Mode

This section describes taking pictures in  (auto) mode, an automatic, “point-and-shoot” mode recommended for first-time users of digital cameras.

1 Press the power switch to turn on the camera.

The lens extends and the monitor turns on.

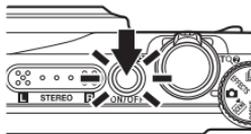
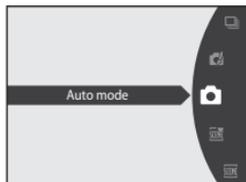
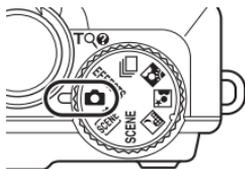
**2 Rotate the mode dial to .****3 Check the battery level indicator and the number of exposures remaining.**

Battery Level Indicator

Display	Description
	Battery level high.
	Battery level low. Prepare to charge or replace the battery.
 Battery exhausted.	Cannot take pictures. Charge or replace the battery.

Battery level indicator

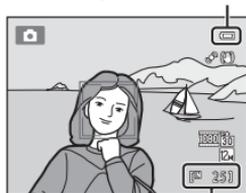

Number of exposures remaining

Number of Exposures Remaining

The number of pictures that can be taken is displayed.

The number of images that can be saved depends on the capacity of the internal memory or memory card and the image mode setting ( 47).

Indicators Displayed in (Auto) Mode

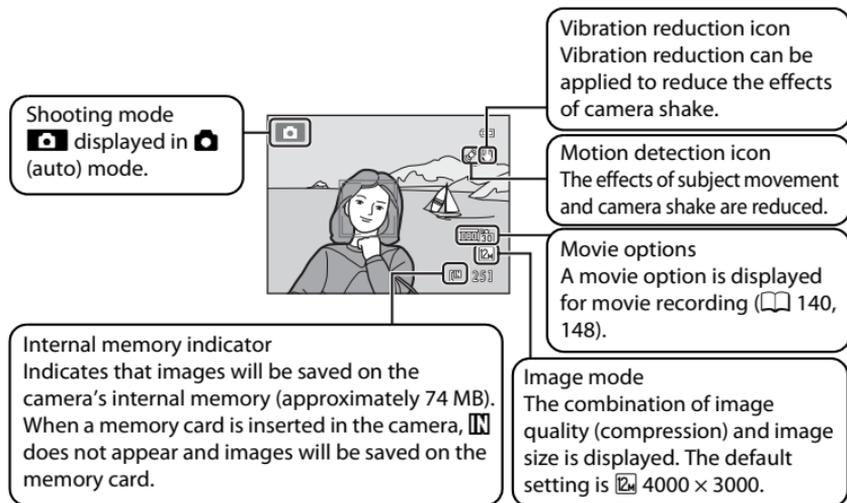

- The indicators and photo info displayed during shooting and playback will turn off after a few seconds (page 175).
- When the monitor has turned off in standby mode to save power (the power-on lamp is blinking) (page 184), press the following buttons to turn it back on.
 - Power switch, shutter-release button, or   

Flash

When the flash is lowered, the flash setting is fixed at off and  appears at the top of the monitor. In situations where flash is needed, such as in dark locations or when the subject is backlit, be sure to raise the flash (page 4, 32).

Functions Available in (Auto) Mode

- The flash mode (page 32) can be adjusted, the self-timer (page 35) and macro mode (page 39) can be applied.
- Brightness (exposure compensation), vividness, and hue can be adjusted with the creative slider (page 40).
- Press the **MENU** button to specify settings for all shooting menu items (page 46) according to shooting conditions. The combination of image quality (compression) and image size can be set by using the **Image mode** option in the shooting menu.

Vibration Reduction and Motion Detection

- See **Vibration reduction** (page 178) and **Motion detection** (page 180) in the setup menu (page 169) for more information.
- Set **Vibration reduction** to **Off** when using a tripod to stabilize the camera during shooting.

Step 2 Frame a Picture

1 Use both hands and ready the camera.

Keep fingers, hair, the camera strap, and other objects away from the lens, flash, AF assist-illuminator, microphone, and speaker.

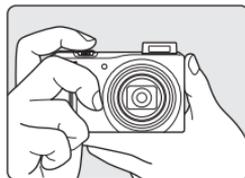

When using the flash (📖 32) while taking pictures in portrait (tall) orientation, turn the camera so that the flash is above the lens.

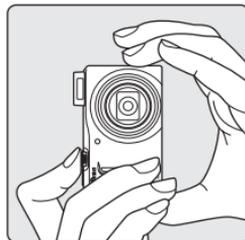

2 Frame the picture.

When the camera detects a human face, that face is framed by a yellow double border (focus area) (default setting).

Up to 12 faces can be detected. When the camera detects more than one face, the face closest to the camera is framed by a double border and the others by single borders.

When shooting non-human subjects or when no faces are detected, the focus area is not displayed. Position the main subject near the center of the frame.



Using the Zoom

Use the zoom control to activate optical zoom. Rotate the zoom control toward **T** to zoom in, increasing the size of the subject. Rotate the zoom control toward **W** to zoom out, increasing the area visible in the frame.

Rotating the zoom control all the way in either direction will adjust the zoom quickly, while rotating the control partially will adjust the zoom slowly.

- When the camera is turned on, the zoom is at the maximum wide-angle position.
- A zoom indicator is displayed at the top of the monitor when the zoom control is rotated.

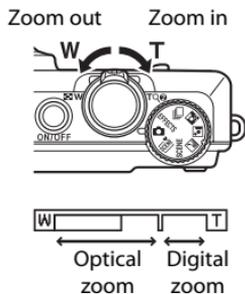

Digital Zoom

When the camera is zoomed in to the maximum optical zoom position, rotating and holding the zoom control at **T** triggers digital zoom.

Digital zoom can magnify the subject up to about 4x beyond the maximum magnification of the optical zoom.

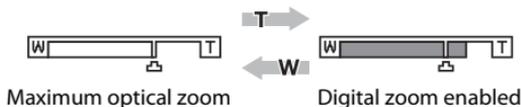

- The camera focuses at the center of the frame and the focus area is not displayed when digital zoom is in effect.

Digital Zoom and Interpolation

Unlike optical zoom, digital zoom uses a digital imaging process known as interpolation to magnify images, resulting in slight deterioration of picture quality according to the image mode (📖 47) and digital zoom magnification.

Interpolation is applied at zoom positions beyond  when taking still images.

When zoom is increased beyond the  position, interpolation is initiated and the zoom indicator turns yellow to indicate that interpolation is being applied.

The position of  moves to the right as image size decreases, allowing for confirmation of the zoom positions at which shooting without interpolation is possible at the current image mode setting.



- Digital zoom can be disabled from the **Digital zoom** option (📖 182) in the setup menu (📖 169).

Step 3 Focus and Shoot

1 Press the shutter-release button halfway.

When the shutter-release button is pressed halfway (📖 9), the camera sets focus and exposure (shutter speed and aperture value). Focus and exposure remain locked while the shutter-release button is pressed halfway.

When a face is detected:

- The camera focuses on the face framed by the double border. When the subject is in focus, the double border glows green.

When a face is not detected:

- The camera has nine focus areas, and automatically selects the focus areas containing the subject closest to the camera. When the subject is in focus, the focus areas that are in focus (up to nine areas) glow green.

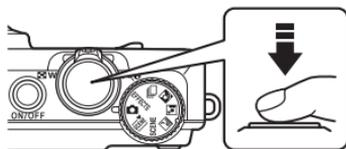

Shutter speed Aperture

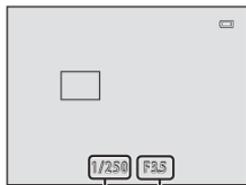

Shutter speed Aperture

The camera focuses at the center of the frame and the focus area is not displayed when digital zoom is in effect. Once focus has been acquired, the focus indicator (📖 6) glows green.

While the shutter-release button is pressed halfway, the focus area or focus indicator may blink red. This indicates that the camera is unable to focus. Modify the composition and press the shutter-release button halfway again.

2 Press the shutter-release button the rest of the way down.

The shutter is released and the image will be saved to the memory card or internal memory.



✔ Note on Saving Images

While images are being saved, the number of exposures remaining will blink. **Do not open the battery-chamber/memory card slot cover** while images are being saved. Cutting power or removing the memory card in these circumstances could result in loss of data or in damage to the camera or card.

✔ Autofocus

Autofocus may not perform as expected in the following situations. In some rare cases, the subject may not be in focus despite the fact that the focus area or the focus indicator glows green:

- Subject is very dark
- Objects of sharply differing brightness are included in the scene (e.g. the sun is behind the subject and the subject is in deep shadow)
- No contrast between the subject and surroundings (e.g. when the subject is wearing a white shirt and is standing in front of a white wall)
- Subject contains objects of varying distances from the camera (such as a cage with an animal inside)
- Subjects with repeating patterns (window blinds, buildings with multiple rows of similarly shaped windows, etc.)
- Subject is moving rapidly

In the situations noted above, try pressing the shutter-release button halfway to refocus several times, or focus on another subject positioned at the same distance from the camera as the actual desired subject, and use focus lock (📖 55).

✔ Note on Face Detection

See "AF Area Mode" (📖 53) or "Face Detection" (📖 56) for more information.

✔ When the Subject Is Close to the Camera

If the camera cannot focus, try shooting with macro mode (📖 39) or the **Close-up** scene mode (📖 70).

✍ AF-assist Illuminator and Flash

If the subject is dimly lit, the AF-assist illuminator (📖 181) may light when the shutter-release button is pressed halfway, or the flash (📖 32) may fire when the shutter-release button is pressed all the way down.

Step 4 Playing Back and Deleting Images

Playing Back Images (Playback Mode)

Press the  (playback) button.

The last image captured will be displayed in full-frame playback mode.

Rotate the rotary multi selector, or press , , , or  to view previous or next images ( 11).

Images may be displayed briefly at low resolution while being read from the memory card or internal memory.

To return to shooting mode, press the  button, shutter-release button, or  (movie-record) button.

When playing back images saved in the camera's internal memory,  is displayed. When a memory card is inserted in the camera,  is not displayed and images saved on the memory card are played back.

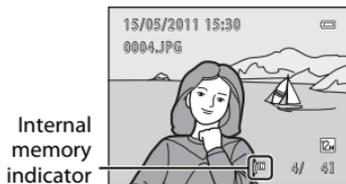
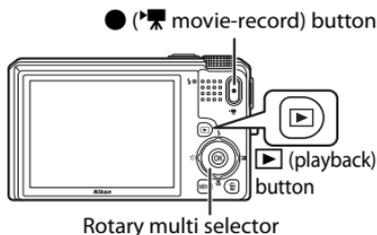

When the Monitor Has Turned Off to Save Power

When the power-on lamp is blinking, press the power switch, shutter-release button,  button, or  (movie-record) button to turn the monitor back on ( 184).

Operations Available in Playback Mode

See "More on Playback" ( 89) or "Editing Images" ( 130) for more information.

Displaying Shooting Information

Press the  button in full-frame playback mode to display the highlight, histogram, and shooting information ( 91). Press the  button again to return to full-frame playback mode.

Pressing the Button to Turn On the Camera

When the camera is off, holding down the  button will turn the camera on in playback mode. The lens will not extend.



Viewing Images

- When images in which the face of a person or a pet was detected at the time of shooting ( 56, 74) are displayed in full-frame playback mode, depending upon the orientation of the detected face, the images may be automatically rotated for playback display (except images captured continuously with the **Pet portrait** scene mode ( 74) or images captured with continuous shooting mode ( 80)).
- For images captured with the continuous shooting feature, each series of images is treated as a group, and only the group's "key picture" is displayed (sequence display →  92).

Deleting Unwanted Images

- 1 Press the  button to delete the image currently displayed in the monitor.

To exit without deleting, press the **MENU** button.

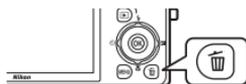

- 2 Press the rotary multi selector  or  to choose the desired deletion method and press the  button.

Current image: Only the current image or voice memo ( 126) is deleted. If the key picture of a sequence group ( 92) is selected, all images in the group are deleted.

Erase selected images: Multiple images can be selected and deleted.

→ “Operating the Erase Selected Images Screen”

All images: All images are deleted.

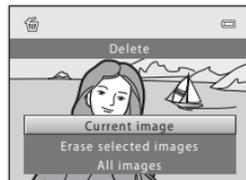

- 3 Press  or  to choose **Yes** and press the  button.

Deleted images cannot be recovered.

To cancel, press  or  to select **No** and press the  button.



Operating the Erase Selected Images Screen

- 1 Press the rotary multi selector  or  to choose an image to be deleted and press  to add  to the image and mark it for deletion.

To undo the selection, press  to remove .

Rotate the zoom control ( 4) to **T** () to switch back to full-frame playback or **W** () to display thumbnails.



- 2 Add  to all desired images and then press the  button to confirm the selection.

A confirmation dialog is displayed. Follow the instructions displayed in the monitor.

Notes on Deletion

- Deleted images cannot be restored. Transfer important images to a computer before deleting them.
- Protected images cannot be deleted ( 122).
- Deleting images captured with the continuous shooting feature → “Deleting Images in a Sequence” ( 93)

Deleting the Last Image Captured While in Shooting Mode

In shooting mode, press the  button to delete the last image captured.

Using the Flash

When the flash is needed, such as when the subject is dimly lit or when there is backlighting, pop the flash up. The flash mode can be set to match the shooting conditions.

- When **ISO sensitivity** is set to **Auto**, the flash has a range of 0.5-4.0 m (1 ft. 8 in.-13 ft.) at the maximum wide-angle zoom position and a range of 1.5-2.5 m (5 ft.-8 ft. 2 in.) at the maximum telephoto zoom position.



Auto

Flash fires automatically when lighting is dim.



Auto with red-eye reduction

Reduce "red-eye" in portraits.



Off

Flash will not fire even when lighting is dim.



Fill flash

Flash fires whenever a picture is taken. Use to "fill-in" (illuminate) shadows and backlit subjects.



Slow sync

Auto flash mode is combined with slow shutter speed.

Suited to evening and night portraits that include background scenery.

Flash illuminates main subject; slow shutter speeds are used to capture background at night or under dim lighting.



Red-eye Reduction

This camera uses **advanced red-eye reduction** (In-Camera Red-Eye Fix). Pre-flashes are fired repeatedly at low intensity before the main flash, reducing the red-eye effect. Additionally, if the camera detects red eye while saving an image, the affected area will be processed to reduce red-eye before the image is saved.

Note the followings when shooting.

- Because pre-flashes are fired, there is a slight lag between when the shutter-release button is pressed and when the shutter is released.
- More time than usual is required to save images.
- Red-eye reduction may not produce the desired results in some situations.
- In extremely rare instances, areas not subject to red-eye may be affected by red-eye reduction processing; in these cases, choose another flash mode and try again.

Setting the Flash Mode

1 Slide the (flash pop-up) control.

The flash pops up.

When the flash is lowered, the flash mode will be fixed at  (off).

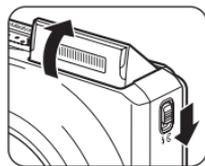

2 Press the rotary multi selector (flash mode).

The flash mode menu is displayed.



3 Use the rotary multi selector to choose the desired mode and press the button.

The icon for the selected flash mode is displayed.

When  (auto) is applied,  is only displayed for a few seconds, regardless of **Photo info** settings ( 176).

If a setting is not applied by pressing the  button within a few seconds, the selection will be canceled.

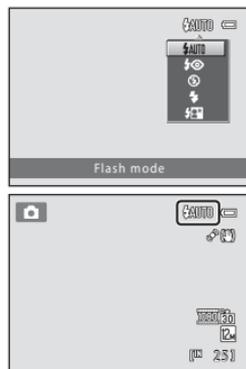

Lowering the Flash

If the flash will not be used, gently lower the flash until it clicks into place.

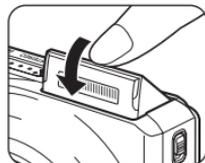

✓ Notes on Shooting When the Flash Is Disabled (🚫) or Lighting Is Dim

- Use of a tripod is recommended to stabilize the camera during shooting. Set **Vibration reduction** (📖 178) to **Off** in setup menu (📖 169) when using a tripod to stabilize the camera.
- **ISO** may be displayed in the shooting screen. When **ISO** is displayed, ISO sensitivity is automatically increased.
- The noise reduction function may be activated with some shooting conditions such as dim lighting. More time than usual is required to save images to which noise reduction is applied.

✓ Note on the Flash

When using the flash, reflections from dust particles in the air may appear as bright spots in images. To reduce these reflections, set the flash to 🚫 (off).

🔧 The Flash Lamp

The flash lamp indicates flash status when the shutter-release button is pressed halfway.

- On: Flash will fire when picture is taken.
- Blinks: Flash charging. Wait a few seconds and try again.
- Off: Flash will not fire when picture is taken.

If the battery is low, the monitor display will turn off, and remain off, until the flash is fully charged.

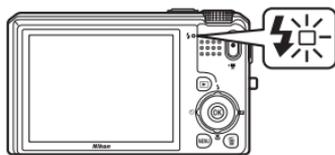

🔧 The Flash Mode Setting

The default flash mode setting varies with shooting mode (📖 45).

- 📷 (auto): **🚫AUTO** (auto)
- 📷 (scene auto selector): **🚫AUTO** (auto). The camera selects the optimum flash mode setting for the scene mode it has selected.
- **SCENE**: varies with the selected scene mode (📖 67–73)
- 🌃 (night landscape): fixed at 🚫 (off)
- 📷 (night portrait): fixed at 🚫👁️ (auto with red-eye reduction)
- 📷 (backlighting): fixed at ⚡ (fill flash) (when **HDR** is Off), fixed at 🚫 (off) (when **HDR** is On) (📖 66)
- 📷 (continuous): fixed at 🚫 (off)
- **EFFECTS** (special effects): **🚫AUTO** (auto)

The flash cannot be used simultaneously with certain functions. See “Camera Settings that Cannot Be Applied Simultaneously” (📖 87) for more information.

The flash mode setting applied in 📷 (auto) mode is saved in the camera’s memory even after the camera is turned off.

Taking Pictures with the Self-timer

The self-timer is useful for self-portraits or reducing the effects of camera shake that occur when the shutter-release button is pressed. The timer can be set to ten or two seconds. When using the self-timer, use of a tripod is recommended. Set **Vibration reduction** (📖 178) to **Off** in the setup menu (📖 169) when using a tripod to stabilize the camera during shooting.

1 Press the rotary multi selector (self-timer).

The self-timer menu is displayed.

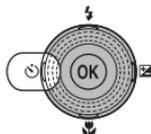

2 Use the rotary multi selector to choose **10s** or **2s** and press the **OK** button.

10s (ten seconds): Use on important occasions, such as weddings.

2s (two seconds): Use to prevent camera shake.

When  is selected, the camera uses face detection to detect a human face, and then automatically releases the shutter when a smile is detected (📖 37).

When the shooting mode is the **Pet portrait** scene mode,  (Pet portrait auto release) is displayed (📖 74). The self-timer settings **10s** and **2s** cannot be used.

The mode selected for self-timer is displayed.

If a setting is not applied by pressing the **OK** button within a few seconds, the selection will be canceled.



3 Frame the picture and press the shutter-release button halfway.

Focus and exposure will be set.

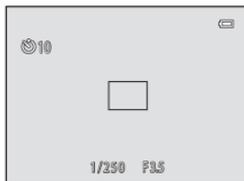

4 Press the shutter-release button the rest of the way down.

The self-timer starts, and the number of seconds remaining before the shutter is released is displayed in the monitor. The self-timer lamp blinks while the timer is counting down. About one second before the shutter is released, the lamp stops blinking and glows steadily.

When the shutter is released, the self-timer will be set to **OFF**.

To stop the timer before a picture is taken, press the shutter-release button again.

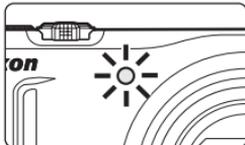

Taking Pictures with the Smile Timer

The camera uses face detection to detect human faces, and then automatically releases the shutter when a smile is detected.

This feature can be used when shooting mode (📖 45) is set to 📷 (auto) mode or the 🌙 (night portrait) or **Portrait** scene mode (📖 61).

1 Press the rotary multi selector 🕒 (self-timer).

The self-timer menu is displayed.

To adjust settings for flash mode, creative slider, exposure compensation, or items in the shooting menu, adjust the settings before pressing 🕒.

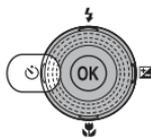

2 Use the rotary multi selector to choose 🕒 (smile timer) and press the OK button.

If a setting is not applied by pressing the OK button within a few seconds, the selection will be canceled.



3 Frame a picture.

Point the camera at the subject.

When the camera detects a human face, a double border (focus area) is displayed around that face. When focus is acquired on that face, the double border will turn green for a moment and focus is locked.

Up to three faces can be detected. When the camera detects more than one face, the double border (focus area) is displayed around the face closest to the center of the frame, and single borders around the others.

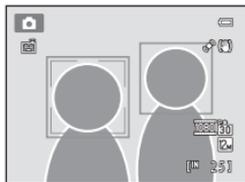

4 The shutter is automatically released.

If the camera detects that the face framed by the double border is smiling, the shutter is automatically released.

Each time the shutter is released, the camera repeats automatic shooting by face detection and smile detection.

5 Finish shooting.

To end automatic shooting by smile detection, either turn off the camera or set the smile timer to **OFF**.

Notes on the Smile Timer

- Digital zoom is not available.
- Under some shooting conditions, the camera may be unable to detect faces or detect smiles.
- See “Notes on Face Detection” (📖 57) for more information.
- This function cannot be used simultaneously with certain functions. See “Camera Settings that Cannot Be Applied Simultaneously” (📖 87) for more information.

Auto Power Off in Smile Timer Mode

When using the smile timer function, the auto off function (📖 184) is activated and the camera turns off when either of the situations indicated below persists and no other operations are performed.

- The camera does not detect any faces.
- The camera detected a face, but cannot detect a smile.

Self-timer Lamp Blinking

When using smile timer, the self-timer lamp blinks slowly when the camera detects a face, and blinks quickly immediately after the shutter is released.

Releasing the Shutter Manually

Pictures can also be taken by pressing the shutter-release button. The camera focuses on the subject at the center of the frame when faces are not detected.

More Information

See “Autofocus” (📖 29) for more information.

Macro Mode

Macro mode is used for taking pictures of objects as close as 4 cm (1.6 in.). Note that the flash may be unable to light the entire subject at distances of less than 50 cm (1 ft. 8 in.).

- 1 Press the rotary multi selector  (macro mode).

The macro mode menu is displayed.

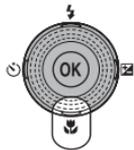

- 2 Use the rotary multi selector to choose **ON** and press the **OK** button.

The macro mode icon () is displayed.

If a setting is not applied by pressing the **OK** button within a few seconds, the selection will be canceled.



- 3 Rotate the zoom control to the zoom position at which  and the zoom indicator glow green.

The closest distance at which the camera can focus varies depending on the zoom position.

When the zoom is at a position where  and the zoom indicator glow green (to the left of ) , the camera can focus on subjects as close as 11 cm (4.4 in.) from the lens. At the maximum wide-angle position, the camera can focus on subjects as close as 4 cm (1.6 in.) from the lens.

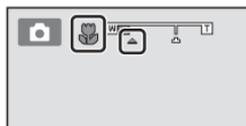

Autofocus

When using  (auto) mode, if **Autofocus mode** ( 60) is set to **Full-time AF**, the camera focuses continuously until the shutter-release button is pressed halfway to lock the focus. Therefore, the sound of lens drive movement can be heard.

When using other shooting modes, **Full-time AF** is turned on automatically when macro mode is turned on.

The Macro Mode Setting

 (auto) mode and continuous shooting mode share the same macro mode setting. When using  (auto) mode or continuous shooting mode, the macro mode setting is saved in the camera's memory even if the camera is turned off.

Adjusting Brightness (Exposure Compensation), Vividness, and Hue

Brightness (exposure compensation), vividness, and hue can be adjusted for taking pictures by pressing the rotary multi selector . Items that can be set vary by the shooting mode.

When Using (Auto) Mode (📖 24) or Continuous Shooting Mode (📖 80)

Brightness (exposure compensation), vividness, and hue can be adjusted with the creative slider.

Brightness (Exp. +/-)

Use to brighten or darken the overall image.

Vividness

Vividness adjustment is used to adjust the vividness of the entire image.

Hue

Hue adjustment is used to adjust the hue of the entire image.

See “Operating the Creative Slider” (📖 41) for more information.

When Using Scene Mode (📖 61) or Special Effects Mode (📖 85)

Brightness (exposure compensation) can be adjusted.

Exposure compensation

Use to brighten or darken the overall image.

See “Adjusting Exposure Compensation” (📖 44) for more information.

Operating the Creative Slider

When using  (auto) mode and  (continuous) mode, use the creative slider to adjust brightness (exposure compensation), vividness, and hue for taking pictures.

1 Press the rotary multi selector .

The creative slider screen is displayed.

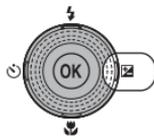

2 Press the rotary multi selector or to choose , , or .

The screen for adjusting  brightness (exposure compensation),  vividness, and  hue is displayed.

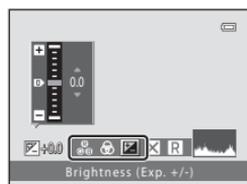

3 Adjust the brightness, vividness, or hue.

The rotary multi selector is used as follows.

-  : The slider moves. The effect can be adjusted while confirming the results in the monitor. The effect can also be adjusted by rotating the rotary multi selector.
-  : Switches between brightness (exposure compensation), vividness, and hue.

For more information on each item, see the following.

- “Adjusting Brightness (Exposure Compensation)” (📖 43)
- “Adjusting Vividness (Saturation Adjustment)” (📖 43)
- “Adjusting Hue (White Balance Adjustment)” (📖 43)

To turn off the effects of the creative slider, press  or  to choose , and press the  button.

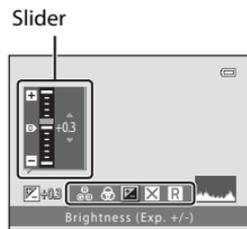

4 When adjustment is complete, press ◀ or ▶ to choose and press the button.

If the  button (except when  is selected) or the shutter-release button is pressed in step 3, the selected amount of effect is applied. When the effect is applied, the camera returns to the shooting screen.

If brightness is adjusted,  and the compensation value are displayed.

If vividness is adjusted,  is displayed.

If hue is adjusted,  is displayed.

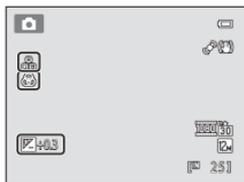
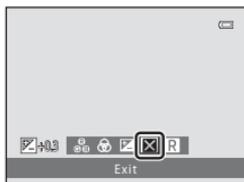

5 Press the shutter-release button to take a picture.

Creative Slider Settings

 (auto) mode and continuous shooting mode share the same settings for brightness (exposure compensation), vividness, and hue; these settings are saved in the camera's memory even when the camera is turned off.

Adjusting Brightness (Exposure Compensation)

Adjust the overall brightness of the image.

- To make the subject brighter, move the slider toward “+”.
- To make the subject darker, move the slider toward “-”.

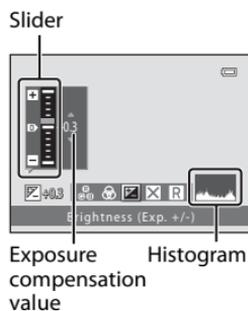

Using the Histogram

A histogram is a graph showing the distribution of tones in the image. Use as a guide when using exposure compensation and shooting without the flash.

- The horizontal axis corresponds to pixel brightness, with dark tones to the left and bright tones to the right. The vertical axis shows the number of pixels.
- Increasing exposure compensation shifts tone distribution to the right, and decreasing it shifts tone distribution to the left.

Adjusting Vividness (Saturation Adjustment)

Adjust the overall vividness of the image.

- Vividness increases as the slider is moved up.
- Vividness decreases as the slider is moved down.

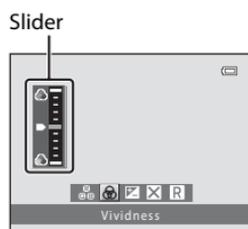

Adjusting Hue (White Balance Adjustment)

Adjust the overall hue of the image.

- The overall image becomes more reddish as the slider is moved up. The overall image becomes more bluish as the slider is moved down.

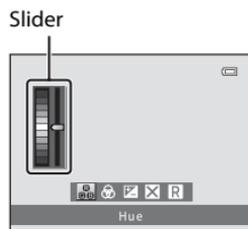

Note on White Balance Adjustment

When hue is adjusted using the creative slider, **White balance** in the shooting menu (📖 49) cannot be set.

Adjusting Exposure Compensation

When using scene mode or special effects mode, brightness (exposure compensation) can be adjusted for taking pictures.

- 1** Press the rotary multi selector  (exposure compensation).

The exposure compensation guide and histogram are displayed.

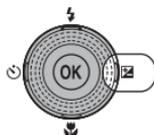

- 2** Use the rotary multi selector to select a compensation value.

To make the subject brighter, apply positive (+) exposure compensation.

To make the subject darker, apply negative (-) exposure compensation.

Exposure compensation guide

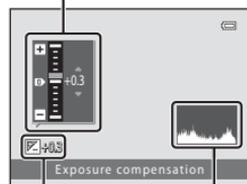

Exposure compensation value

- 3** Press the  button to set the compensation value.

When an exposure compensation value other than **0.0** is applied, the value is displayed with the  indicator in the monitor.

- 4** Press the shutter-release button to take a picture.

To reset exposure compensation, repeat from step 1 and set the value to **0.0**, then press  button.



Histogram

See "Using the Histogram" (📖 43) for more information.

Selecting a Shooting Mode (Mode Dial)

Rotate the mode dial and align an icon to the mark to select one of the following shooting modes.

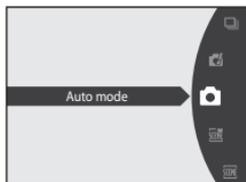
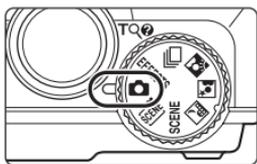

(Auto) mode (📖 24)

Pictures can be taken with an automatic, point-and-shoot mode recommended for first-time users of digital cameras. Brightness, vividness, and hue can be adjusted using the creative slider. Various settings are available in the shooting menu (📖 46).

EFFECTS Special effects (📖 85)

Effects can be applied to images during shooting. Six different effects are available.

Continuous shooting mode (📖 80)

Change settings to Continuous or BSS (best shot selector).



Scene mode (📖 61)

Camera settings are automatically optimized for the selected scene.

 (Scene auto selector) : By simply framing a picture, the camera automatically selects the optimum scene mode for simpler shooting.

SCENE : Choose the desired scene from 15 different scene types, and the camera's settings are automatically optimized for the selected scene.

 (Night landscape) : Captures the atmosphere of night landscapes.

 (Night portrait) : The flash fires to light the portrait subject while preserving the atmosphere of the evening or night view.

 (Backlighting) : The flash fires when there is backlight to prevent the subject from being hidden in shadow, or use the HDR function to shoot when there are very bright areas and very dark areas in the same frame.

Changing (Auto) Mode Settings (Shooting Menu)

The following options can be set when shooting in  (auto) mode ( 24).

Image mode

 47

Choose the image mode (combination of image size and compression rate) at which images are saved. This setting can be changed when using any shooting mode.

White balance

 49

In order to make the colors in images appear as they do to the eye, set white balance to suit the light source.

Metering

 51

Choose how the camera meters exposure.

ISO sensitivity

 52

Set the ISO sensitivity to suit the brightness of the subject.

AF area mode

 53

Choose how the camera selects the focus area for autofocus.

Autofocus mode

 60

Choose how the camera focuses.

Displaying the Shooting Menu

Rotate the mode dial to  (auto) mode ( 45).

Press the **MENU** button to display the shooting menu.

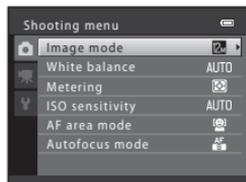
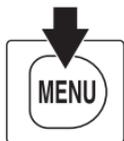

- Use the rotary multi selector to choose and apply settings ( 11).
- To exit the shooting menu, press the **MENU** button.

Camera Settings that Cannot Be Applied Simultaneously

Some functions cannot be enabled in conjunction with others ( 87).

Image Mode (Image Quality/Image Size)

 (auto) → MENU (Shooting menu) → Image mode

Image mode refers to the combination of image size and image quality (compression) at which images are saved. Choose the image mode best suited to the manner in which images will be used and the capacity of the internal memory or memory card. The higher the image mode setting, the larger the size at which it can be printed or displayed without appearing noticeably “grainy,” but limiting the number of images that can be saved.

Image mode	Size (pixels)	Description
 4000×3000★	4000 × 3000	Images will be higher quality than  . The compression ratio is approximately 1:4.
 4000×3000 (default setting)	4000 × 3000	Best choice in most situations. The compression ratio is approximately 1:8.
 3264×2448	3264 × 2448	
 2592×1944	2592 × 1944	
 2048×1536	2048 × 1536	Smaller size than  ,  , or  allows more images to be saved. The compression ratio is approximately 1:8.
 1024×768	1024 × 768	Suited to display on a computer monitor. The compression ratio is approximately 1:8.
 640×480	640 × 480	Suited to full-screen display on a television with an aspect ratio of 4:3, or distribution by e-mail. The compression ratio is approximately 1:8.
 3968×2232	3968 × 2232	Images with an aspect ratio of 16:9 are saved. The compression ratio is approximately 1:8.

The icon for the current setting is displayed in the monitor in shooting and playback modes ( 6, 8).

Image Mode

- When using shooting modes other than  (auto) mode, this setting can be changed by pressing the MENU button.
- The setting is also applied to other shooting modes.
- This function cannot be used simultaneously with certain functions. See “Camera Settings that Cannot Be Applied Simultaneously” ( 87) for more information.

 **Number of Exposures Remaining**

The following table lists the approximate number of images that can be saved in the internal memory and on a 4 GB memory card. Note that due to JPEG compression, the number of images that can be saved differs depending on the composition of the image. In addition, this number may vary depending on the make of memory card, even when the memory cards have the same specified capacity.

Image mode	Internal memory (approx. 74 MB)	Memory card ¹ (4 GB)	Print size ² (cm/in.)
 4000×3000★	12	650	34 × 25/13 × 10
 4000×3000	25	1280	34 × 25/13 × 10
 3264×2448	37	1910	28 × 21/11 × 8
 2592×1944	58	2940	22 × 16/8.5 × 6.5
 2048×1536	91	4640	17 × 13/7 × 5
 1024×768	297	15000	9 × 7/3.5 × 2.5
 640×480	528	24100	5 × 4/2 × 1.5
 3968×2232	34	1720	34 × 19/13 × 7.5

¹ If the number of exposures remaining is 10,000 or more, the number of exposures remaining display shows “9999.”

² Print size at an output resolution of 300 dpi. Print sizes are calculated by dividing the number of pixels by printer resolution (dpi) and multiplying by 2.54 cm (1 in.). However, at the same image size, images printed at higher resolutions will print smaller than the size indicated, and those printed at lower resolutions will print larger than the size indicated.

White Balance (Adjusting Hue)

 (auto) → MENU (Shooting menu) → White balance

The color of light reflected from an object varies with the color of the light source. The human brain is able to adapt to changes in the color of the light source, with the result that white objects appear white whether seen in the shade, direct sunlight, or under incandescent lighting. Digital cameras can mimic this adjustment by processing images according to the color of the light source. This is known as “white balance.” For natural colors, choose a white balance setting that matches the light source before shooting. Although the default setting, **Auto**, can be used under most types of lighting, the white balance setting suited to a particular light source can be specified manually to achieve more accurate results.

AUTO Auto (default setting)

White balance is automatically adjusted to suit lighting conditions. Best choice in most situations.

PRE Preset manual

Useful when shooting under unusual lighting. See “Preset Manual” for more information ( 50).

Daylight

White balance adjusted for direct sunlight.

Incandescent

Use under incandescent lighting.

Fluorescent

Use under fluorescent lighting.

Cloudy

Use when taking pictures under overcast skies.

Flash

Use with the flash.

The icon for the current setting is displayed in the monitor ( 6). However, when **Auto** is selected, no icon is displayed.

Notes on White Balance

- When hue is adjusted using the creative slider ( 41), this feature cannot be set.
- This function cannot be used simultaneously with certain functions. See “Camera Settings that Cannot Be Applied Simultaneously” ( 87) for more information.
- At white-balance settings other than **Auto** or **Flash**, turn the flash off (  32).

White Balance Settings

This setting can be set by pressing the **MENU** button even when using continuous shooting mode ( 80).  (auto) mode and continuous shooting mode share the same **White balance** setting.

Preset Manual

Preset manual is used with mixed lighting or to compensate for light sources with a strong color cast when the desired effect has not been achieved with white balance settings like **Auto** and **Incandescent** (for example, to make images shot under a lamp with a red shade look as though they had been shot under white light).

Use the procedure below to measure the white balance value under the lighting used during shooting.

- 1 Place a white or gray reference object under the lighting that will be used during shooting.
- 2 Display the shooting menu ( 46), use the rotary multi selector to choose **PRE Preset manual** in the **White balance** menu, and press the  button.

The camera zooms in to the position for measuring white balance.

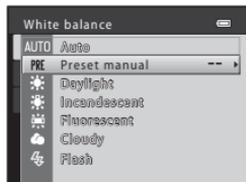

- 3 Choose **Measure**.

To apply the most recently measured white balance value, choose **Cancel** and press the  button. The white balance setting will not be measured again and the most recently measured value will be set.

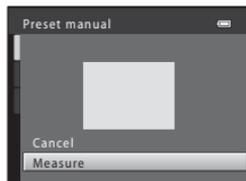

- 4 Frame the reference object in the measuring window.

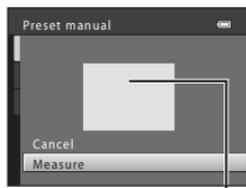

Measuring window

- 5 Press the  button to measure a value for preset manual.

The shutter is released and the new white-balance value is set. No image is saved.

Note on Preset Manual

A value for flash lighting cannot be measured with **Preset manual**. When shooting using the flash, set **White balance** to **Auto** or **Flash**.

Metering

 (auto) → MENU (Shooting menu) → Metering

The process of measuring the brightness of the subject to determine exposure is known as metering.

Choose how the camera meters exposure.

Matrix (default setting)

Uses a wide area of the screen for metering. This metering mode provides the appropriate exposure for a variety of shooting conditions. Recommended for typical shooting.

Center-weighted

The camera meters the entire frame but assigns greatest weight to the subject in the center of the frame. Classic meter for portraits; preserves background details while letting lighting conditions at the center of the frame determine exposure. Can be used with focus lock ( 55) to meter off-center subjects.

Note on Metering

While digital zoom is in effect, metering is set to center-weighted metering or spot metering (the area in the center of the monitor is metered). The active metering area is not displayed.

Metering Settings

This setting can be set by pressing the **MENU** button even when using continuous shooting mode ( 80).  (auto) mode and continuous shooting mode share the same **Metering** setting.

Metering Area

The active metering area is displayed in the monitor when **Center-weighted** is selected for **Metering**.

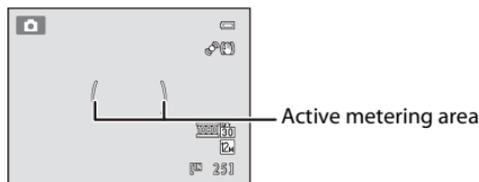

ISO Sensitivity

 (auto) → MENU (Shooting menu) → ISO sensitivity

When ISO sensitivity is increased, less light is needed when taking pictures. Higher ISO sensitivity allows darker subjects to be captured. Additionally, even with subjects of similar brightness, pictures can be taken at faster shutter speeds, and blurring caused by camera shake and subject movement can be reduced.

- Although higher ISO sensitivity is effective when shooting darker subjects, shooting without the flash, shooting with the camera zoomed in, etc., images may contain noise.

Auto (default setting)

Sensitivity is ISO 160 when there is sufficient lighting; the camera compensates by raising sensitivity to a maximum of ISO 800 when lighting is dim.

Fixed range auto

Limits the ISO sensitivity to ISO 160-400 when the camera automatically adjusts ISO sensitivity. The camera sets the maximum value for ISO sensitivity to 400 for effective control over the amount of “grain” that appears in images.

160, 200, 400, 800, 1600, 3200

ISO sensitivity is locked at the specified value.

The icon for the ISO sensitivity setting is displayed in the monitor ( 6).

- When **Auto** is selected, the  icon is not displayed at ISO 160, but is displayed if the ISO sensitivity automatically increases to more than 160 ( 34).
- When **Fixed range auto** is selected,  400 is displayed.

Notes on ISO Sensitivity

- This function cannot be used simultaneously with certain functions. See “Camera Settings that Cannot Be Applied Simultaneously” ( 87) for more information.
- **Motion detection** ( 180) does not function when the ISO sensitivity is set to any setting other than **Auto**.

ISO Sensitivity Settings

This setting can be set by pressing the **MENU** button even when using continuous shooting mode ( 80).  (auto) mode and continuous shooting mode share the same **ISO sensitivity** setting.

AF Area Mode

 (auto) → MENU (Shooting menu) → AF area mode

Use this option to determine how the camera selects the focus area for autofocus.

Face priority (default setting)

When the camera detects a human face, it focuses on that face. See “Face Detection” ( 56) for more information. If more than one face is detected, the camera focuses on the face closest to the camera. When taking pictures of subjects other than people, or framing a subject with which no face is detected, the **AF area mode** setting switches to **Auto**, and the camera will automatically select the focus area (up to nine areas) containing the subject closest to the camera.

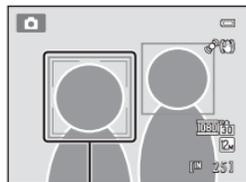

Focus area

AUTO Auto

The camera has nine focus areas, and automatically selects the focus areas containing the subject closest to the camera. Press the shutter-release button halfway to activate the focus area. When the shutter-release button is pressed halfway, the focus areas that are in focus (up to nine areas) selected by the camera will be displayed in the monitor.

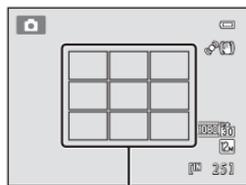

Focus areas

Manual

Select one of 99 focus areas in the monitor. This option is suited to situations in which the intended subject is relatively still and not positioned in the center of the frame.

Rotate the rotary multi selector or press , , , or  to move the focus area to where the subject is, and take a picture.

- To change settings for any of the following functions, first press the  button to cancel focus-area selection, then change the settings as desired.
 - Flash mode, macro mode, self-timer
 - Brightness (exposure compensation), vividness, hue
 To return to the focus area selection screen, press the  button again.

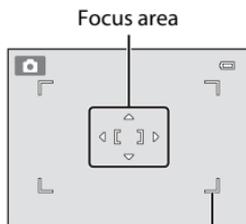

Selectable focus area

Center

The camera focuses on the subject at the center of the frame.

The focus area is always displayed at the center of the screen.

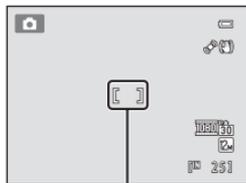

Focus area

Subject tracking

By registering a subject, the focus area will automatically move to track and focus on the subject. → "Focusing on a Moving Subject (Subject Tracking)" (📖 58).



Notes on AF Area Mode

- When digital zoom is in effect, focus will be on the center of the screen regardless of the **AF area mode** setting.
- This function cannot be used simultaneously with certain functions. See "Camera Settings that Cannot Be Applied Simultaneously" (📖 87) for more information.
- Autofocus may not perform as expected (📖 29).

AF Area Mode Settings

This setting can be set by pressing the **MENU** button even when using continuous shooting mode (📖 80).  (auto) mode and continuous shooting mode share the same **AF area mode** setting.

Focus Lock

Use focus lock to focus on off-center subjects when center is selected for AF area mode.

The following steps explain the usage of focus lock when **Center** is selected for **AF area mode**.

- 1 Position the subject in the center of the frame.
- 2 Press the shutter-release button halfway.
 - Confirm that the focus area glows green.
 - Focus and exposure are locked.
- 3 Continue holding down the shutter-release button halfway and recompose the picture.
 - Be sure to maintain the same distance between the camera and the subject while the shutter-release button is pressed halfway.
- 4 Press the shutter-release button the rest of the way down to take the picture.



Face Detection

When the camera is pointed at the face of a person, the camera detects the face and focuses on it. The face detection function is activated in the following situations.

- When AF area mode is set to **Face priority** in  (auto) mode or continuous shooting mode ( 53)
- When the following scene modes are selected:
 - Scene auto selector ( 62)
 -  (night portrait) ( 65)
 - **Portrait** ( 67)
- When smile timer is selected ( 37)

1 Frame a picture.

When the camera detects a face, that face is framed by a yellow double border.

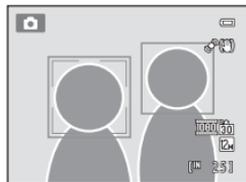

When the camera detects more than one face, operation varies as follows depending upon the shooting mode.

Shooting mode	Face framed by double border	Number of faces that can be detected
 (auto) mode or continuous shooting mode (Face priority) Scene auto selector,  (night portrait), and Portrait scene modes	The face closest to the camera <ul style="list-style-type: none"> • Other faces framed by single border. 	Up to 12
Smile timer	The face closest to the center of the frame <ul style="list-style-type: none"> • Other faces framed by single border. 	Up to 3

2 Press the shutter-release button halfway.

The camera focuses on the face framed by the double border. The double border turns green and focus is locked.

When the camera is unable to focus, the double border will blink. Press the shutter-release button halfway again to focus.

Press the shutter-release button the rest of the way down to take a picture.

When using smile timer, the shutter is released automatically if the camera detects that the face framed by the double border is smiling; there is no need to press the shutter-release button ( 37).



Notes on Face Detection

- If the camera is unable to detect any faces when the shutter-release button is pressed halfway with AF area mode set to **Face priority**, the AF area mode setting automatically switches to **Auto**.
- If no faces are detected when the shutter-release button is pressed halfway in the **Portrait** and  (night portrait) scene modes, the camera will focus on the subject at the center of the frame.
- The camera's ability to detect faces depends on a variety of factors, including whether or not the subject is facing the camera. The camera may be unable to detect faces in the following situations:
 - When faces are partially hidden by sunglasses or otherwise obstructed
 - When faces take up too much or too little of the frame
- When the frame includes more than one face, the faces detected by the camera and the face on which the camera focuses depend upon a variety of factors, including the direction in which the faces are looking.
- When using autofocus and shooting subjects that are difficult to focus on ( 29), the subject may not be in focus even though the double border is green. If the subject is not in focus, change AF area mode to **Manual** or **Center** in  (auto) mode, and try focus lock shooting ( 55) by focusing on another subject that is the same distance from the camera.
- Images captured using face detection will be rotated and displayed automatically according to the orientation of the faces detected, in full-frame and thumbnail playback modes (excluding images captured using continuous shooting mode ( 80)).

Focusing on a Moving Subject (Subject Tracking)

Use this mode to take pictures of moving subjects. By registering a subject, the camera can move the focus area automatically to track the subject.

- 1** Press the **MENU** button in  (auto) mode or continuous mode.

The shooting menu or continuous menu is displayed.

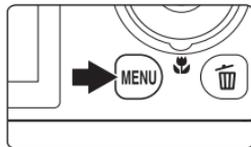

- 2** Use the rotary multi selector to select **Subject tracking** in the **AF area mode** option and press the **OK** button.

AF area mode. →  53

Press the **MENU** button after changing the settings and return to the shooting screen.

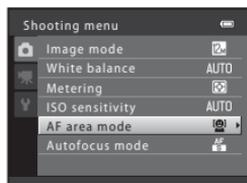

- 3** Register a subject.

Align the subject with the white border at the center of the frame and press the **OK** button.

- The subject is registered.
- When the camera is unable to focus on the subject, the border will glow red. Change the composition and try registering the subject again.

When the subject is registered, a yellow double border (focus area) is displayed around that subject.

To change the subject, press the **OK** button to deregister the current subject.

If the camera cannot track the registered subject anymore, the focus area will disappear and the registration will be canceled. Register the subject again.



4 Press the shutter-release button to take a picture.

The camera focuses on the focus area when the shutter-release button is pressed halfway. The focus area will glow green and focus will be locked.

When the camera is unable to focus, the focus area will blink. Press the shutter-release button halfway again to focus.

If the shutter-release button is pressed halfway while the focus area is not displayed, the camera focuses on the subject at the center of the frame.

Press the shutter-release button all the way down to release the shutter.

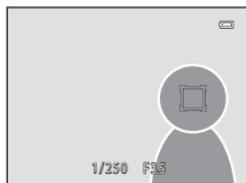

Notes on Subject Tracking

- Digital zoom is not available.
- Adjust zoom position, flash mode, exposure compensation, and menu settings prior to registering the subject. If any camera setting is changed after the subject has been registered, subject registration will be canceled.
- It may be impossible to register the desired subject, or the camera may be unable to track the registered subject or may begin tracking a different subject, if the subject is moving rapidly, if there is a significant amount of camera shake, or if the camera detects a similar subject. The camera's ability to accurately track the registered subject is also dependent upon the size and brightness of the subject.
- When using autofocus and shooting subjects that are difficult to focus on ( 29), the subject may not be in focus even though the focus area glows green. If the subject is not in focus, change **AF area mode** ( 53) to **Manual** or **Center** in  (auto) mode, and try focus lock shooting ( 55) by focusing on another subject that is the same distance from the camera.
- There may be functions with which this setting cannot be enabled. See "Camera Settings that Cannot Be Applied Simultaneously" ( 87) for more information.

Autofocus Mode

 (auto) → MENU (Shooting menu) → Autofocus mode

Choose how the camera focuses.



Single AF (default setting)

The camera focuses when the shutter-release button is pressed halfway.



Full-time AF

The camera focuses continuously until the shutter-release button is pressed down halfway. Use with moving subjects. The sound of lens drive movement will be heard while the camera focuses.

Note on Autofocus Mode

There may be functions with which this setting cannot be enabled. See “Camera Settings that Cannot Be Applied Simultaneously” ( 87) for more information.

Autofocus Mode Setting

This setting can be set by pressing the **MENU** button even when using continuous shooting mode ( 80).  (auto) mode and continuous shooting mode share the same **Autofocus mode** setting.

Autofocus Mode for Movie Recording

Autofocus mode for movie recording can be set with **Autofocus mode** ( 150) in the movie menu ( 146).

Shooting Suited to Scenes (Scene Mode)

When one of the following scenes is selected using the mode dial or the scene menu, images are captured using settings that are optimized for the selected scene.

 (Scene auto selector)
(📖 62)

By simply framing a picture, the camera automatically selects the optimum scene mode for simpler shooting.



 Night Landscape
(📖 64)

 Night Portrait (📖 65)

 Backlighting (📖 66)

Rotate the mode dial to , or  and take pictures.

SCENE

Press the **MENU** button to display the scene menu and choose one of the following shooting scenes.

 Portrait (default setting) (📖 67)	 Landscape (📖 67)
 Sports (📖 68)	 Party/indoor (📖 68)
 Beach (📖 69)	 Snow (📖 69)
 Sunset (📖 69)	 Dusk/dawn (📖 70)
 Close-up (📖 70)	 Food (📖 71)
 Museum (📖 72)	 Fireworks show (📖 72)
 Black and white copy (📖 73)	 Panorama (📖 73)
 Pet portrait (📖 74)	

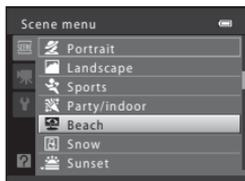
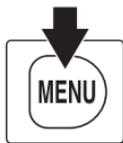
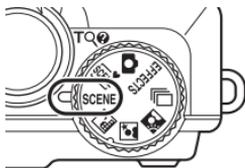

- Choose a scene type from the scene menu and rotate the zoom control (📖 4) to **T** (🔍) to view a description (help) of that scene. To return to the original screen, rotate the zoom control to **T** (🔍) again.

Image Mode

The **Image mode** setting (📖 47) can be changed by pressing the **MENU** button in scene mode. Changes made to the image mode setting apply to all shooting modes.

Shooting in the Scene Mode Selected by the Camera (Scene Auto Selector)

By simply framing a picture, the camera automatically selects one of the following scene modes for simpler shooting.

- : Auto (general shooting)
- : Landscape
- : Night landscape
- : Backlighting
- : Portrait
- : Night portrait
- : Close-up

1 Rotate the mode dial to .

The camera enters scene auto selector.

If the flash is closed, **The flash is lowered.** is displayed.

Slide the  (flash pop-up) control to make the flash pop up.

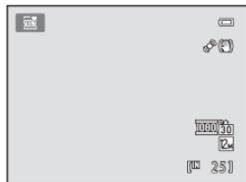
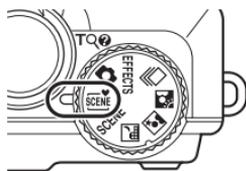

2 Frame the subject and take a picture.

The shooting mode icon changes.

Press the shutter-release button halfway to set focus and exposure. When the subject is in focus, the active focus area glows green.

Press the shutter-release button the rest of the way down to take the picture.

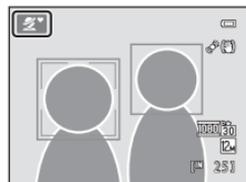

✓ Notes on Scene Auto Selector

- Digital zoom is not available.
- Depending upon shooting conditions, the camera may not select the desired scene mode. Should this occur, switch to  (auto) mode (📖 24) or select the desired scene manually (📖 64).

✎ Focusing Using Scene Auto Selector

- When the camera detects a human face in scene auto selector, it focuses on that face. See “Face Detection” (📖 56) for more information.
- When the shooting mode indicator  or  (close-up) is displayed, the camera automatically selects the focus area (up to nine areas) containing the subject closest to the camera as same as when **Auto** is selected for **AF area mode** (📖 53).

✎ Shooting with Night Landscape and Night Portrait When Using Scene Auto Selector

- If the camera switches to  (night landscape) when using scene auto selector, the camera captures a series of images which will be combined into a single image and saved.
- If the camera switches to  (night portrait) when using scene auto selector, flash mode is fixed at red-eye reduction for shooting human subjects (the camera does not shoot continuously).
- In dark surroundings, the use of a tripod is recommended. Set **Vibration reduction** (📖 178) to **Off** when using a tripod to stabilize the camera.

✎ Flash

-  **AUTO** (auto; default setting) and  (off) flash mode settings can be applied (📖 32).
 - When  **AUTO** (auto) is selected, the camera automatically selects the optimum flash mode setting for the scene mode it has selected.
 - When  (off) is selected, the flash does not fire even if the flash is popped up.
- To make sure the flash does not fire, take pictures with the flash lowered.

✎ Functions Available in Scene Auto Selector

- The self-timer (📖 35) and exposure compensation (📖 40) settings can be adjusted.
- Smile timer (📖 37) cannot be used.
- The macro mode button on the rotary multi selector (📖 39) is disabled.

Choosing a Scene and Shooting (Scene Mode Types and Characteristics)

The mode dial can be used to select scenes when shooting (📖 61).

See “Shooting in the Scene Mode Selected by the Camera (Scene Auto Selector)” (📖 62) for more information on scene auto selector.

⚡ is used in the following scene descriptions to indicate the flash mode (📖 32) setting when the flash is raised. ⌚ indicates the self-timer (📖 35), 🌸 indicates macro mode (📖 39), and 📷 indicates exposure compensation (📖 40) settings.

📷 Night landscape

Captures the atmosphere of night landscapes.

Press the **MENU** button to set **Night landscape** to **Hand-held** or **Tripod**.

- **Hand-held** (default setting): Select this option to produce shots with reduced blurring and noise even when the camera is hand-held.
 - The 📷 icon is displayed in the shooting screen.
 - When the 📷 icon at the top left of the monitor lights in green, press the shutter-release button all the way to capture a series of images which will be combined into a single image and saved.
 - Once the shutter-release button is pressed all the way, hold the camera steady without moving it until a still image is displayed. After taking a picture, do not turn the camera off before the monitor switches to the shooting screen.
 - The angle of view (i.e., the area visible in the frame) seen in the saved image will be narrower than that seen in the monitor at the time of shooting.
- **Tripod**: Select this option when using a tripod or other means to stabilize the camera during shooting.
 - The 📷 icon is displayed in the shooting screen.
 - **Vibration reduction** (📖 178) is automatically set to **Off** regardless of the setting in the setup menu (📖 169).
 - One image is captured at a slow shutter speed when the shutter-release button is pressed all the way.
- Digital zoom is not available.
- Camera focuses at infinity. The focus area always glows green when the shutter-release button is pressed halfway. Note, however, that objects in the foreground may not always be in focus.
- AF-assist illuminator (📖 181) does not light.



⚡	⌚	🌸	Off ¹	📷	Off	📷	0.0 ²
---	---	---	------------------	---	-----	---	------------------

¹ The self-timer can be used.

² Other settings can be selected.

Night portrait

Use this mode for portraits of a human subject shot in front of background lighting at night. Flash is used to illuminate the subject while maintaining the mood of the background.

Press the **MENU** button to set **Night portrait** to **Hand-held** or **Tripod**.



- **Hand-held:** Select this option to produce shots with reduced blurring and noise even when the camera is hand-held.
 - The  icon is displayed in the shooting screen.
 - When the  icon at the top left of the monitor lights in green, press the shutter-release button all the way to capture a series of images which will be combined into a single image and saved.
 - Once the shutter-release button is pressed all the way, hold the camera steady without moving it until a still image is displayed. After taking a picture, do not turn the camera off before the monitor switches to the shooting screen.
 - The angle of view (i.e., the area visible in the frame) seen in the saved image will be narrower than that seen in the monitor at the time of shooting.
 - If the subject moves while the camera is shooting continuously, the image may be distorted, overlapped, or blurred.
- **Tripod** (default setting): Select this option when using a tripod or other means to stabilize the camera during shooting.
 - The  icon is displayed in the shooting screen.
 - **Vibration reduction** ( 178) is automatically set to **Off** regardless of the setting in the setup menu ( 169).
 - One image is captured at a slow shutter speed when the shutter-release button is pressed all the way.
- Raise the flash before taking pictures.
- Digital zoom is not available.
- When the camera detects a human face, it focuses on that face (see “Face Detection” ( 56) for more information).
 - If more than one face is detected, focus will be on the face closest to the camera.
 - The camera softens skin tones (in up to three faces) by applying the skin softening function before saving images ( 67).
 - If no faces are detected, the camera focuses on the subject at the center of the frame.

	 ¹		Off ²		Off		0.0 ²
-------------------------------------------------------------------------------------	--------------------------------------------------------------------------------------------------	-------------------------------------------------------------------------------------	------------------	-------------------------------------------------------------------------------------	-----	-------------------------------------------------------------------------------------	------------------

¹ The flash fires using red-eye reduction.

² Other settings can be selected.

Shooting Suited to Scenes (Scene Mode)

Backlighting

Use when light is coming from behind the subject, throwing features or details into shadow.

Press the **MENU** button to set **HDR** to **On** or **Off** according to the shooting conditions and subject.

When **HDR** is set to **Off** (default setting): The flash fires to prevent the subject from being hidden in shadow.

- Raise the flash before taking pictures.
- The camera focuses on the subject at the center of the frame. One image is captured when the shutter-release button is pressed all the way.



When **HDR** is set to **On**: Use when taking pictures with very bright and dark areas in the same frame.

- The **HDR** icon is displayed in the shooting screen. If there are very bright areas and very dark areas in the frame, the  icon lights in green.
- The camera focuses on the subject at the center of the frame. Digital zoom is not available.
- When the shutter-release button is pressed all the way, the camera shoots images continuously at high speed, and saves the following two images.
 - An image processed by D-Lighting (📖 133) at the time of shooting
 - A composite image with high dynamic range (HDR) in which the loss of details in highlights or shadows is minimized
- The second image saved is an HDR composite image. If there is only enough memory to save one image, an image processed by D-Lighting is the only image saved.
- Once the shutter-release button is pressed all the way, hold the camera steadily without moving it until a still image is displayed. After taking a picture, do not turn the camera off before the monitor switches to the shooting screen.
- The angle of view (i.e., the area visible in the frame) seen in the saved image will be narrower than that seen in the monitor at the time of shooting.



¹ Flash is fixed at  (fill flash) when **HDR** is set to **Off**, and is fixed at  (off) when **HDR** is set to **On**.

² The self-timer can be used.

³ Other settings can be selected.

SCENE →  Portrait

Use this mode for portraits.

- The camera detects and focuses on a human face. See “Face Detection” (📖 56) for more information.
- If more than one face is detected, focus will be on the face closest to the camera.
- The camera softens skin tones (in up to three faces) by applying the skin softening function before saving images.
- If no faces are detected, the camera focuses on the subject at the center of the frame.
- Digital zoom is not available.

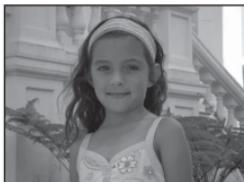

* Other settings can be selected.

SCENE →  Landscape

Use this mode for vivid landscapes and cityscapes.

- Camera focuses at infinity. The focus area or focus indicator (📖 7) always glows green when the shutter-release button is pressed halfway. Note, however, that objects in the foreground may not always be in focus.
- AF-assist illuminator (📖 181) does not light.



* Other settings can be selected.

Notes about Skin Softening

When using the  (night portrait) or **Portrait** scene modes, the camera detects up to three human faces when the shutter is released, and processes the image to soften facial skin tones before saving the image.

- More time than usual is required to save images.
- The level of effect applied cannot be adjusted. Confirm the result by playing back the image.
- Skin softening can also be applied on saved images (📖 134).
- In some shooting conditions, facial skin tones may not be smoothed or parts other than face may be modified though the camera detects a face.

Shooting Suited to Scenes (Scene Mode)

Sports

Use this mode for dynamic action shots that freeze the action in a single shot and record motion in a series of pictures. With continuous shooting, instantaneous movements in moving subjects can be captured clearly.

- The camera focuses on the subject in the center of the frame. The camera focuses continuously until the shutter-release button is pressed halfway to lock the focus.
- While the shutter-release button is held all the way down, up to 24 images are captured continuously at a rate of up to about 1.8 fps (when image mode is set to  **4000x3000**).
- Shooting ends when the shutter-release button is released.
- Focus, exposure compensation, and white balance are fixed at the values determined with the first shot in each series.
- The speed of continuous shooting may decrease depending on the image mode, the type of memory card used, and shooting conditions.
- AF-assist illuminator ( 181) does not light.



			Off		Off		0.0*
-----------------------------------------------------------------------------------	-----------------------------------------------------------------------------------	-----------------------------------------------------------------------------------	-----	-----------------------------------------------------------------------------------	-----	-----------------------------------------------------------------------------------	------

* Other settings can be selected.

SCENE → Party/indoor

Suitable for taking pictures in parties. Captures the effects of candlelight and other indoor background lighting.

- The camera focuses on the subject at the center of the frame.
- As images are easily affected by camera shake, hold the camera steadily. In dark surroundings, the use of a tripod is recommended. Set **Vibration reduction** ( 178) to **Off** when using a tripod to stabilize the camera.



	 ¹		Off ²		Off		0.0 ²
-----------------------------------------------------------------------------------	------------------------------------------------------------------------------------------------	-----------------------------------------------------------------------------------	------------------	-----------------------------------------------------------------------------------	-----	-----------------------------------------------------------------------------------	------------------

¹ The flash mode setting may automatically switch to slow sync with red-eye reduction. Other settings can be selected.

² Other settings can be selected.

SCENE →  Beach

Captures the brightness of such subjects as beaches or sunlit expanses of water.

- The camera focuses on the subject at the center of the frame.



* Other settings can be selected.

SCENE →  Snow

Captures the brightness of sunlit snow.

- The camera focuses on the subject at the center of the frame.



* Other settings can be selected.

SCENE →  Sunset

Preserves the deep hues seen in sunsets and sunrises.

- The camera focuses on the subject at the center of the frame.



* Other settings can be selected.

: Use of a tripod is recommended in scenes with which  is indicated. Set **Vibration reduction** ( 178) to **Off** when using a tripod to stabilize the camera.

Shooting Suited to Scenes (Scene Mode)

SCENE → Dusk/dawn

Preserves the colors seen in the weak natural light before sunrise or after sunset.

- Camera focuses at infinity. The focus area or focus indicator ( 7) always glows green when the shutter-release button is pressed halfway. Note, however, that objects in the foreground may not always be in focus.
- AF-assist illuminator ( 181) does not light.



Off*



Off



0.0*

* Other settings can be selected.

SCENE → Close-up

Use this mode to photograph flowers, insects, and other small objects at close range.

- Macro mode ( 39) is enabled and the camera automatically zooms to the closest position at which it can focus.
- The closest distance at which the camera can focus varies depending on the zoom position.

When the zoom is at a position where  and the zoom indicator glow green (to the left of ) , the camera can focus on subjects as close as 11 cm (4.4 in.) from the lens. At the maximum wide-angle position, the camera can focus on subjects as close as 4 cm (1.6 in.) from the lens.

- **AF area mode** is set to **Manual** and the focus area in which the camera focuses can be selected ( 53). Press the  button and then move the focus area by rotating the rotary multi selector or by pressing , , , or .

To change settings for any of the following functions, first press the  button to cancel focus-area selection, then change the settings as desired.

- Flash mode
- Self-timer
- Exposure compensation

- The camera focuses continuously until the shutter-release button is pressed halfway to lock the focus.
- As images are easily affected by camera shake, be sure that **Vibration reduction** ( 178) is enabled and hold the camera steadily.



Off*



On



0.0*

* Other settings can be selected. Note that the flash may be unable to light entire subject at distances of less than 50 cm (1 ft. 8 in.).

: Use of a tripod is recommended in scenes with which  is indicated. Set **Vibration reduction** ( 178) to **Off** when using a tripod to stabilize the camera.

SCENE →  Food

Use this mode when taking pictures of food.

- Macro mode ( 39) is enabled and the camera automatically zooms to the closest position at which it can focus.
- The closest distance at which the camera can focus varies depending on the zoom position.

When the zoom is at a position where  and the zoom indicator glow green (to the left of ) , the camera can focus on subjects as close as 11 cm (4.4 in.) from the lens. At the maximum wide-angle position, the camera can focus on subjects as close as 4 cm (1.6 in.) from the lens.

- Hue can be adjusted in the range of the slider displayed on the left in the monitor. Press the rotary multi selector  to make the image more reddish, or  to make it more bluish. The hue setting is saved in the camera's memory even after the camera is turned off.

- **AF area mode** is set to **Manual** and the focus area in which the camera focuses can be selected ( 53). Press the  button and then move the focus area by rotating the rotary multi selector or by pressing , , , or .

To change settings for any of the following functions, first press the  button to cancel focus-area selection, then change the settings as desired.

- Hue
- Self-timer
- Exposure compensation

- The camera focuses continuously until the shutter-release button is pressed halfway to lock the focus.
- As images are easily affected by camera shake, be sure that **Vibration reduction** ( 178) is enabled and hold the camera steadily.

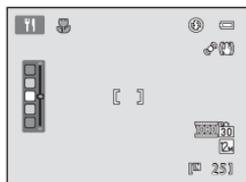

			Off*		On		0.0*
-----------------------------------------------------------------------------------	-----------------------------------------------------------------------------------	-----------------------------------------------------------------------------------	------	-----------------------------------------------------------------------------------	----	-----------------------------------------------------------------------------------	------

* Other settings can be selected.

Shooting Suited to Scenes (Scene Mode)

SCENE → Museum

Use indoors where flash photography is prohibited (for example, in museums and art galleries) or in other settings in which you do not want to use the flash.

- Camera focuses on the subject at the center of the frame.
- BSS (best shot selector) can be enabled ( 82).
- As images are easily affected by camera shake, be sure that **Vibration reduction** ( 178) is enabled and hold the camera steadily.
- AF-assist illuminator ( 181) does not light.



* Other settings can be selected.

SCENE → Fireworks show

Slow shutter speeds are used to capture the expanding burst of light from a firework.

- Camera focuses at infinity. The focus indicator ( 6) always glows green when the shutter-release button is pressed halfway. Note, however, that objects in the foreground may not always be in focus.
- AF-assist illuminator ( 181) does not light.
- Only the five optical zoom positions shown on the right can be applied. When the zoom control is rotated, zoom will not stop at any position other than the five indicated (digital zoom is available).

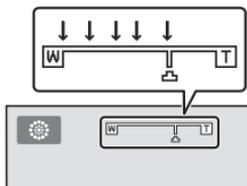

: Use of a tripod is recommended in scenes with which  is indicated. Set **Vibration reduction** ( 178) to **Off** when using a tripod to stabilize the camera.

SCENE →  Black and white copy

Provides clear images of text or drawings on a white board or in print.

- Camera focuses on the subject at the center of the frame.
- Use macro mode ( 39) to focus at short ranges.
- Colored text and drawings may not show up well.

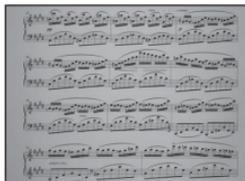

* Other settings can be selected.

SCENE →  Panorama

Use this mode to take panorama pictures.

From the screen displayed after the  **Panorama** scene mode is selected, select **Easy panorama** or **Panorama assist**.

- **Easy panorama** (default setting): By simply moving the camera in the desired direction, panoramas that can be played back using the camera can be taken.
 - "Shooting with Easy Panorama" ( 75)
 - "Playing Images Captured with Easy Panorama" ( 77)
- **Panorama assist**: Use this setting to take a series of pictures while confirming how each image will connect to the next. After transferring the images to a computer, the images can be joined by using the supplied **Panorama Maker 5** software ( 161).
 - "Shooting with Panorama Assist" ( 78)



¹ Can be changed when using **Panorama assist**.

² Self-timer can be used when using **Panorama assist**.

³ Other settings can be selected.

 **Note on Printing Panoramas**

When printing panoramas, the entire image may not be able to be printed depending on the printer's settings. Additionally, printing may not be possible depending on the printer.

See the documentation provided with the printer or consult the digital photo lab for details.

Shooting Suited to Scenes (Scene Mode)

SCENE → 🐾 Pet portrait

Use this mode when taking pictures of dogs or cats. When the camera detects the face of a dog or cat, the camera focuses on that face. Once the camera has focused, by default it automatically releases the shutter (pet portrait auto release).



- From the screen displayed after the 🐾 **Pet portrait** scene mode is selected, select **Single** or **Continuous**.

- Single:** Images are captured one at a time.
- Continuous:** Three images are captured continuously when a face is focused on (at a rate of about 1.8 fps when image mode is **4000x3000**). While **Continuous** is selected, the is displayed in the shooting screen.

- When the camera detects a face, a double border (focus area) is displayed around the face, and the double border glows green when the camera has focused. The faces of up to five pets can be detected at the same time. When the camera detects more than one face, the face displayed largest in the monitor is framed by a double border and the others by single borders.

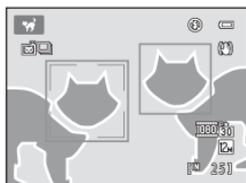

- If no pet faces are detected, the shutter can be released by pressing the shutter-release button.
 - If no pet faces are detected, the camera focuses on the subject at the center of the frame.
 - When **Continuous** is selected, up to 24 images are captured continuously at a rate of about 1.8 fps (when image mode is set to **4000x3000**) while the shutter-release button is held all the way down. Shooting ends when the shutter-release button is released.
- Press the rotary multi selector to change auto release settings.
 - Pet portrait auto release** (default setting): The camera automatically releases the shutter when it focuses on the detected face. While **Pet portrait auto release** is selected, the icon is displayed in the shooting screen.
 - Off:** The shutter is released only when the shutter-release button is pressed.
- Digital zoom is not available.
- AF-assist illuminator (181) does not light. Button sounds and the shutter sound (183) are disabled.
- Depending on the distance of the pet from the camera, the speed of the pet's movement, the direction the pet is facing, the ambient brightness of the pet's face, etc., dog and cat faces may not be detected and faces of other animals may be detected.
- Pet portrait auto release** is automatically set to **Off** in the following situations.
 - When five series of images are captured using auto release
 - When the camera is turned back on after entering standby mode (19)
 - When there is no remaining space in the internal memory or on the memory cardTo continue using **Pet portrait auto release** to take more pictures, press the rotary multi selector and change the setting again.



¹ Can be set to Off. Self-timer (10s, 2s) is not available.

² Other settings can be selected.

5 Press the shutter-release button all the way, and then remove your finger from the shutter-release button.

▷ is displayed to indicate the direction the camera movement.



6 Move the camera slowly and straight in one of the four directions, and begin shooting.

When the camera detects which direction it is moving in, shooting begins.

A guide indicating the current shooting position is displayed.

When the shooting position guide reaches the edge, shooting ends.



Exposure compensation guide

Example of camera movement

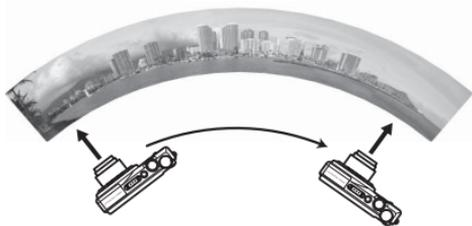

The operator, without shifting position, moves the camera horizontally or vertically in an arc.

Move the camera from one edge of the panorama range to the other, in about 15 seconds for 180° shooting angles, and about 30 seconds for 360° shooting angles.

✓ Notes on Easy Panorama Shooting

- The range of the image seen in the saved image will be narrower than that seen in the monitor at the time of shooting.
- If the camera is moved too quickly or if the camera is shaken too much, an error will occur.
- If shooting is stopped before the camera reaches the half-way point in the panorama range, a panorama image is not saved.
- If more than half of the panorama range is captured but shooting ends before reaching the edge of the range, the range not captured is recorded and displayed in gray.

Playing Images Captured with Easy Panorama

Switch to playback mode (📖 30, 89), display an image captured using easy panorama in full-frame playback mode, and then press the **OK** button to display the short edge of the image using the entire monitor and automatically move (scroll) the displayed area.



The image scrolls in the direction that was used when shooting.

Rotate the rotary multi selector to advance or rewind.

Playback controls are displayed at the top of the monitor during playback. Press the rotary multi selector ◀ or ▶ to choose a control, and then press the **OK** button to use the following operations.



Function	Icon	Description	
Rewind	◀◀	Hold down the OK button to scroll backward quickly.	
Advance	▶▶	Hold down the OK button to scroll forward quickly.	
Pause	⏸	The following operations can be performed while playback is paused using the controls displayed at the top in the monitor	
		◀◀	Hold down the OK button to rewind.*
		▶▶	Hold down the OK button to scroll.*
	▶	Resume automatic scrolling.	
End	■	Switch to full-frame playback mode.	

* Scrolling can also be performed by rotating the rotary multi selector.

✔ Note on Easy Panorama Scroll Playback

The COOLPIX S9100 may not be able to scroll the playback of, or zoom in on, easy panorama images captured with another make or model of digital camera.

Shooting with Panorama Assist

The camera focuses on the subject at the center of the frame. Use a tripod for the best results. Set **Vibration reduction** (📖 178) to **Off** in setup menu (📖 169) when using a tripod to stabilize the camera.

- 1 Rotate the mode dial to **SCENE**, press the **MENU** button and choose **📷 Panorama** (📖 61).

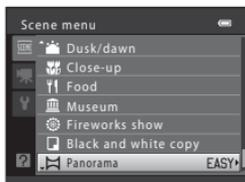
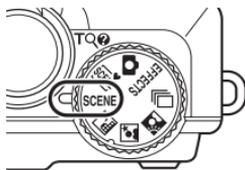

- 2 Choose **ASSIST Panorama assist** and press the **OK** button.

Panorama direction icons are displayed to show the direction in which images will be joined.

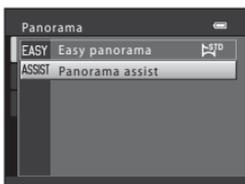

- 3 Use the rotary multi selector to choose the direction and press the **OK** button.

Select the direction in which images will be joined in the completed panorama; right (▶), left (◀), up (▲), or down (▼).

The yellow panorama direction icon (▶▶) is displayed for the current direction and the direction is fixed when the **OK** button is pressed. The icon changes to the white fixed direction ▶▶ icon.

If necessary, apply flash mode (📖 32), self-timer (📖 35), macro mode (📖 39), and exposure compensation (📖 40) settings with this step.

Press the **OK** button again to choose a different direction.



- 4 Frame the first portion of the panorama scene and take the first picture.

One third of the image will be displayed as translucent.



5 Take the next picture.

Frame the next image so that one third of the frame overlaps the first image, and press the shutter-release button.

Repeat this process until the necessary number of images has been taken to complete the scene.

**6 Press the \odot button when shooting is complete.**

The camera returns to step 2.

**✓ Notes on Panorama Assist**

- Set flash mode, self-timer, macro mode and exposure compensation before taking the first picture. They cannot be changed after the first picture is taken. Images cannot be deleted, nor can zoom or **Image mode** setting (📖 47) be adjusted after the first picture is taken.
- Shooting ends if the auto off function (📖 184) is activated. If the camera enters standby mode during shooting, set **Auto off** to a longer setting.

🔍 AE/AF-L Indicator

In panorama assist mode, exposure, white balance, and focus for all images in a panorama are fixed at the values for the first image in each series.

When the first picture is taken, **AE/AF-L** is displayed to indicate that exposure, white balance, and focus are locked.

**🔍 Combining Images to Make a Panorama**

Transfer images to a computer (📖 157) and use Panorama Maker 5 (📖 161) to join them in a single panorama.

Install Panorama Maker 5 from the supplied ViewNX 2 CD.

🔍 More Information

See "File and Folder Names" (📖 199) for more information.

Burst Shooting (Continuous Shooting Mode)

Use this mode to capture the details of a moving subject by shooting a continuous series of images.

- The focus, exposure, and white balance settings are fixed at the values for the first picture in each series.

1 Rotate the mode dial to (continuous).

The camera enters continuous shooting mode.

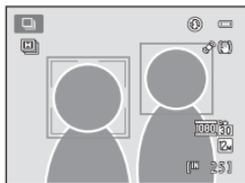
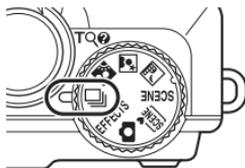

2 Press the **MENU** button and confirm or change the settings in the continuous menu.

See “Continuous Menu” (📖 82) for more information.

Press the **MENU** button after changing the settings and return to the shooting screen.

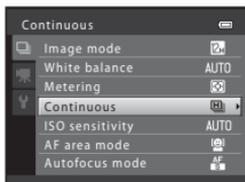

3 Frame the subject and shoot.

By default, if the camera detects a human face, it focuses on that face (see “Face Detection” (📖 56) for more information). If the camera does not detect any faces, the camera selects the focus areas (up to nine areas) containing the subject closest to the camera.

Press the shutter-release button halfway to lock focus and exposure.

When **Continuous H**, **Continuous L**, **Pre-shooting cache**, or **BSS** is selected in the continuous menu, images are captured while the shutter-release button is held all the way down.

When **Continuous H: 120 fps**, **Continuous H: 60 fps**, or **Multi-shot 16** is selected in the continuous menu, the number of images determined by the setting are captured when the shutter-release button is pressed all the way. There is no need to hold the shutter-release button down.

After taking a picture, the camera returns to the shooting screen. If  is displayed, do not turn the camera off.

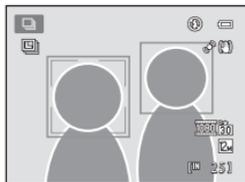

✓ Notes on Continuous Shooting Mode

- It may take some time to save the images after shooting. The amount of time it takes to finish saving the captured images depends on the number of images, image mode, the write speed of the memory card, etc.
- When ISO sensitivity increases, noise may appear in captured images.
- The speed of continuous shooting may decrease depending on the image mode, type of memory card used, and shooting conditions.
- When **Continuous** is set to **Pre-shooting cache**, **Continuous H: 120 fps**, **Continuous H: 60 fps**, or **Multi-shot 16**, banding or variance in brightness or hue may occur in images that were captured under lighting that flickers at high speeds, such as fluorescent, mercury-vapor, or sodium-vapor lighting.

✎ Functions Available in Continuous Shooting Mode

- Brightness (exposure compensation), vividness, and hue can be adjusted with the creative slider (📖 40).
- Press the **MENU** button to display the  (continuous) menu and change continuous shooting mode settings (📖 82).
- Flash and self-timer cannot be used.

📷 Images Captured in Continuous Shooting Mode

Each time images are captured using **Continuous H**, **Continuous L**, **Pre-shooting cache**, **Continuous H: 120 fps**, or **Continuous H: 60 fps**, the captured images are saved as a “sequence” (📖 92).

🔍 More Information

- See “Autofocus” (📖 29) for more information.
- See “Playing Images Captured Using Continuous Shooting Mode (Sequence)” (📖 92) for more information.

Changing Continuous Shooting Mode Settings

After displaying the  (continuous) mode shooting screen (📖 80), press the **MENU** button (📖 5) to set the following options in the continuous menu.

- Items other than **Continuous** share the same settings with  (auto) mode, and the settings are saved in the camera's memory even if the camera is turned off.
- Use the rotary multi selector to choose and apply settings (📖 11, 12).
- To exit the shooting menu, press the **MENU** button.
- Some functions cannot be enabled in conjunction with others (📖 87).

Image mode 📖 47

Choose the image mode (combination of image size and compression rate) at which images are saved (except for **Continuous H: 120 fps**, **Continuous H: 60 fps**, and **Multi-shot 16**).

Changes made to the image mode setting apply to all shooting modes.

White balance 📖 49

In order to make the colors in images appear as they do to the eye, set white balance to suit the light source.

Metering 📖 51

Choose how the camera meters exposure.

Continuous

Choose the desired continuous shooting option.

Continuous settings can be confirmed in the monitor when shooting (📖 6).

Option	Description
 Continuous H (default setting)	While the shutter-release button is held all the way down, images are captured continuously at a rate of about 9.5 fps (when image mode is set to  4000×3000). Shooting ends when the shutter-release button is released, or 5 images have been captured.
 Continuous L	While the shutter-release button is held all the way down, up to 24 images are captured continuously at a rate of up to about 1.8 fps (when image mode is set to  4000×3000). Shooting ends when the shutter-release button is released.

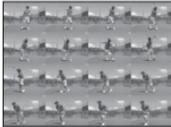
Option	Description
 Pre-shooting cache	<p>Pre-shooting cache makes it easy to capture perfect moments, by saving images from before the shutter-release button was pressed all the way. Pre-shooting cache shooting begins when the shutter-release button is pressed halfway, and continues when the shutter-release button is pressed all the way (📖 84).</p> <ul style="list-style-type: none"> • Frame rate: up to 7.5 fps • Number of frames: Up to five frames (including up to two frames captured in the pre-shooting cache) <p>Shooting ends when the shutter-release button is released or when the maximum number of frames has been shot.</p>
 120 Continuous H: 120 fps	<p>Each time the shutter-release button is pressed all the way, 50 frames are captured at a speed of about 1/125 s or faster. Image mode is fixed at  (image size: 1280 × 960 pixels).</p>
 60 Continuous H: 60 fps	<p>Each time the shutter-release button is pressed all the way, 25 frames are captured at a speed of about 1/60 s or faster. Image mode is fixed at  (image size: 1600 × 1200 pixels).</p>
 BSS BSS (best shot selector)	<p>The “best shot selector” is recommended when shooting with the flash off or the camera zoomed in, or in other situations in which inadvertent motion can result in blurred images. The camera captures a series of up to five images while the shutter-release button is held all the way down, and the sharpest image in the series is automatically selected and saved.</p> <ul style="list-style-type: none"> • BSS is best suited to shooting subjects that are not moving. When shooting moving subjects or when the composition of the picture changes while shooting, the desired results may not be achieved.
 Multi-shot 16	<p>Each time the shutter-release button is pressed, camera takes 16 shots at a rate of about 30 fps and arranges them in a single image.</p> <ul style="list-style-type: none"> • Image mode is fixed at  (image size: 2560 × 1920 pixels). • Digital zoom is not available. 

Burst Shooting (Continuous Shooting Mode)

ISO sensitivity

52

Set the ISO sensitivity to suit the brightness of the subject.

AF area mode

53

Use this option to determine how the camera selects the focus area for autofocus.

Autofocus mode

60

Choose how the camera focuses.

Pre-shooting Cache

When **Pre-shooting cache** is selected, shooting begins when the shutter-release button is pressed halfway for 0.5 seconds or longer, and images captured before the shutter-release button is pressed all the way are saved along with images captured after the shutter-release button is pressed all the way. Up to two images can be saved in the pre-shooting cache.

The pre-shooting cache setting can be confirmed in the monitor when shooting (6). When the pre-shooting cache is not set, no icon is displayed. The pre-shooting cache icon lights in green while the shutter-release button is pressed halfway.

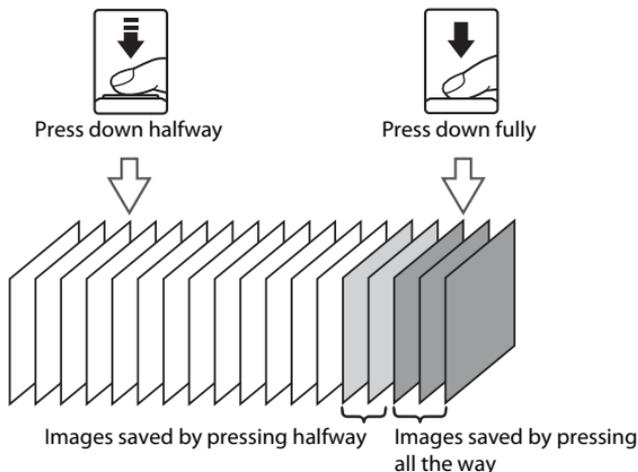

- If the number of exposures remaining is less than five, shooting with the pre-shooting cache is not possible. Before shooting, check that there are five or more exposures remaining.

Applying Effects When Shooting (Special Effects Mode)

One of the following effects can be applied to images during shooting.

Option	Description
Soft	Softens the image by adding a slight blur to the entire image.
Nostalgic sepia	Adds a sepia tone and reduces the contrast to simulate the qualities of an old photograph.
High-contrast monochrome	Changes the image to black and white and gives it sharp contrast.
High key	Gives the entire image a bright tone.
Low key	Gives the entire image a dark tone.
Selective color	Creates a black and white image in which only the specified color remains.

1 Rotate the mode dial to **EFFECTS** (special effects).

The camera enters special effects mode.

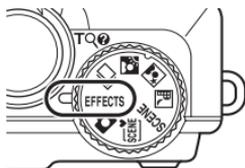

2 Press the **MENU** button to display the special effects menu, use the rotary multi selector to choose **Special effects**, and then press the **OK** button.

The screen for selecting the desired special effect is displayed.

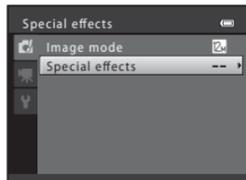

3 Press ▲ or ▼ to choose an effect and press the OK button.

Press the **MENU** button after changing the settings and return to the shooting screen.

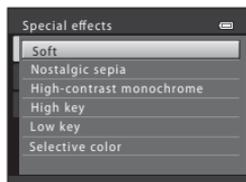

4 Frame the subject and shoot.

The camera focuses on the subject at the center of the frame.

- When **Selective color** is selected in step 3, rotate the rotary multi selector or press ▲ or ▼ to select the desired color from the slider.

To change settings for any of the following functions, first press the OK button to cancel color selection, then change the settings as desired.

- Flash mode (📖 32)
- Self-timer (📖 35)
- Macro mode (📖 39)
- Exposure compensation (📖 44)

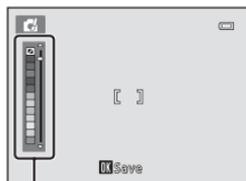

Slider

To return to the color selection screen, press the OK button again.



Functions Available in Special Effects Mode

- Press the **MENU** button to display the  (special effects) menu and select **Image mode** to choose the image mode (combination of image size and compression rate) used when saving images. Changes made to the image mode setting apply to all shooting modes (📖 47).
- Flash mode (📖 32), self-timer (📖 35), macro mode (📖 39), and exposure compensation (📖 44) can be set.

Camera Settings that Cannot Be Applied Simultaneously

Some settings in the  (auto) mode (📖 24) shooting menu (📖 46), the continuous shooting mode (📖 80) shooting menu (📖 82), and the continuous menu cannot be used with other functions.

Restricted function	Setting	Descriptions
Self-timer	AF area mode (📖 53)	When AF area mode is set to Subject tracking , self-timer is not available.
Macro mode	AF area mode (📖 53)	When AF area mode is set to Subject tracking , macro mode is not available.
Image mode	Continuous (📖 80)	When using Continuous H: 120 fps , image mode is fixed at 1 (image size: 1280 × 960 pixels). When using Continuous H: 60 fps , image mode is fixed at 2 (image size: 1600 × 1200 pixels). When using Multi-shot 16 , image mode is fixed at 5 (image size: 2560 × 1920 pixels).
White balance	Hue (using the creative slider) (📖 41)	When hue is adjusted using the creative slider, White balance in the shooting menu cannot be set.
	Continuous (📖 80)	When shooting with Pre-shooting cache , Continuous H: 120 fps , or Continuous H: 60 fps , White balance is fixed at Auto .
Metering	Continuous (📖 80)	When shooting with Pre-shooting cache , Continuous H: 120 fps , or Continuous H: 60 fps , Metering is fixed at Matrix .
ISO sensitivity	Continuous (📖 80)	When shooting with Continuous L 3200 cannot be selected. If Continuous L is selected when ISO sensitivity is set to 3200 , sensitivity changes to 1600 .
		When shooting with Pre-shooting cache , Continuous H: 120 fps , Continuous H: 60 fps , or Multi-shot 16 , the ISO sensitivity setting is automatically set according to the brightness.

Camera Settings that Cannot Be Applied Simultaneously

Restricted function	Setting	Descriptions
AF area mode	Smile timer (📖 37)	Face detection is used regardless of the AF area mode setting.
	Continuous (📖 80)	When shooting with Pre-shooting cache , Continuous H: 120 fps , or Continuous H: 60 fps , AF area mode is fixed at Center .
Autofocus mode	Continuous (📖 80)	When shooting with Pre-shooting cache , Continuous H: 120 fps , or Continuous H: 60 fps , Autofocus mode is fixed at Single AF .
Print date	Continuous (📖 80)	When using any setting other than Multi-shot 16 , the date is not imprinted.
Motion detection	ISO sensitivity (📖 52)	Motion detection is disabled when the ISO sensitivity is set to any setting other than Auto .
	AF area mode (📖 53)	When AF area mode is set to Subject tracking , Motion detection is not available.
AF assist	Continuous (📖 80)	When shooting with Pre-shooting cache , Continuous H: 120 fps , or Continuous H: 60 fps , the AF-assist illuminator does not light.
Digital zoom	AF area mode (📖 53)	When AF area mode is set to Subject tracking , digital zoom is not available.
	Continuous (📖 80)	When using Multi-shot 16 , digital zoom is disabled.
Blink warning	Smile timer (📖 37)	Blink warning does not function.

✔ Features Not Available in Continuous Shooting Mode

When using continuous shooting mode, the following features cannot be used.

- Flash mode (📖 32)
- Self-timer (📖 35)/Smile timer (📖 37)
- Motion detection (📖 180)
- Blink warning (📖 188)

💡 More Information

See "Notes on Digital Zoom" (📖 182) for more information.

Operations in Full-frame Playback Mode

Press the  (playback) button in shooting mode to enter playback mode and display images that have been captured ( 30).



The following operations are available in full-frame playback mode.

Function	Control	Description	
Select images		Press  ,  ,  , or  to display previous or next images. Press and hold  ,  ,  , or  to scroll quickly through images. Images can also be selected by rotating the rotary multi selector.	11
Switch to thumbnail display/calendar display mode	W 	Display images by 4, 9, 16, or 72 image thumbnails. Rotate the zoom control to W  with 72 thumbnails displayed to switch to calendar display. (except for list by date mode)	94, 96
Playback zoom	T 	Rotate the zoom control to T  to enlarge the image up to 10x. Press the  button to return to full-frame playback mode.	97
Display shooting information		Display the histogram and the shooting information. Press the  button to return to full-frame playback.	91
Scroll playback of pictures taken using easy panorama		Display the short edge of the displayed image using the entire monitor, and automatically move the displayed area.	77
Display individual images of a sequence		If pressed when displaying a sequence that is displayed by its key picture only, all images in the sequence are displayed as individual images. To return to key picture only display, press the rotary multi selector  .	92
Play back movies		Play back the movie currently displayed.	152

Function	Control	Description	
Delete images		Select a deletion method and delete images. When using favorite pictures mode ( 101), auto sort mode ( 109), or list by date mode ( 113), images in the same album, category, or shooting date can be deleted.	31, 93
Display menus	MENU	Display the menu for the selected mode.	115
Switch to another playback mode	MENU	Display the menu and select the MODE (playback mode) tab to switch to favorite pictures mode, auto sort mode, or list by date mode.	99
Switch to shooting mode		Press the  button or shutter-release button. The  button can also be used to switch to shooting mode.	30
			
			

Changing the Orientation (Vertical/Horizontal) of Images

After shooting, image orientation can be changed during playback with **Rotate image** ( 124) of the playback menu ( 115).

Displaying the Histogram and Shooting Information

Press the **OK** button in full-frame playback mode to display the highlight, histogram, and the shooting information. Press the **OK** button again to return to full-frame playback mode.

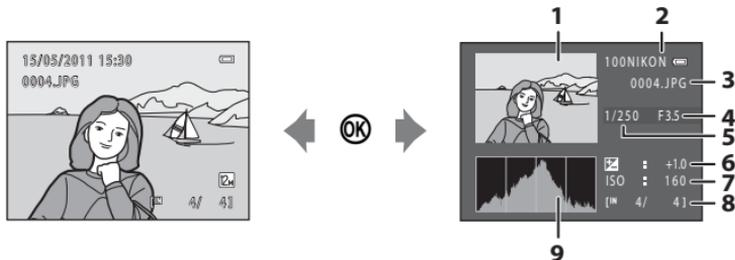

1 Highlight¹

2 Folder name

3 File name

4 Aperture

5 Shutter speed

6 Exposure compensation

7 ISO sensitivity

8 Current frame number/
total number of frames

9 Histogram²

¹ Areas of the image that are extremely bright (highlight areas) blink. Use as a guide when using exposure compensation to adjust image brightness.

² A histogram is a graph showing the distribution of tones in the image. The horizontal axis corresponds to brightness, with dark tones to the left and bright tones to the right. The vertical axis shows the number of pixels.

✓ Notes on Histogram and Shooting Information

Not displayed for the following:

- Images in a sequence (when only the key picture is displayed to represent all images)
- Panoramas captured with easy panorama
- Movies

Playing Images Captured Using Continuous Shooting Mode (Sequence)

Each series of images captured using the following settings is saved in a sequence.

- Continuous shooting mode (📖 80)
 - Continuous H
 - Continuous L
 - Pre-shooting cache
 - Continuous H: 120 fps
 - Continuous H: 60 fps
- Scene mode (📖 64)
 - Sports
 - Pet portrait mode (when **Continuous** is selected)

In full-frame playback mode or thumbnail playback mode (📖 94), the first image of a sequence is used as the “key picture”, i.e., it is displayed to represent the images in the sequence.

- 📄 is displayed in the playback screen for images captured in a sequence (📖 8).

While the key picture of a sequence is displayed in full-frame playback mode, press the **OK** button to display each image in the sequence individually. To return to key picture only display, press the rotary multi selector ▲.



The following operations are available when each image in a sequence is displayed individually.

- Choose an image: Rotate the rotary multi selector or press ◀ or ▶.
- Zoom in: Rotate the zoom control to **T** (📖 97).
- Display the histogram and shooting information: Press the **OK** button (📖 91).

📄 Sequence Display Options

Select **Sequence display options** (📖 129) in the playback menu to set all sequences to be displayed using their key pictures or to display them as individual images.

📄 Changing Key Picture in Sequence

A sequence's key picture can be changed using **Choose key picture** (📖 129) in the playback menu.

Deleting Images in a Sequence

If **Sequence display options** (📖 129) in the playback menu is set to **Key picture only**, press the  button to select a deletion method and delete the following images.

- If only the key picture is displayed to represent all images:
 - **Current image:** When a sequence is selected, all images in that sequence are deleted.
 - **Erase selected images:** When the key picture is selected in the deletion image selection screen (📖 31), all images in the sequence are deleted.
 - **All images:** All images are deleted, including the currently displayed sequence.
- If the key picture is selected and the  button is pressed to display each individual image in the sequence before pressing the  button:

Deletion methods change as follows.

 - **Erase current picture:** The image currently displayed is deleted.
 - **Erase selected images:** When multiple images in the same sequence are selected in the deletion image selection screen (📖 31), the selected images are deleted.
 - **Erase entire sequence:** All images in the sequence, including the image currently displayed, are deleted.

Note on Sequence

Images captured continuously with cameras other than the COOLPIX S9100 cannot be displayed as a sequence.

Playback Menu Options Available When Using Sequence

When the **MENU** button is pressed during key picture playback, the following menu operations are available for the images in that sequence.

- Quick retouch¹ (📖 132)
- Skin softening¹ (📖 134)
- Frame¹ (📖 137)
- Slide show (📖 121)
- Rotate image¹ (📖 124)
- Voice memo¹ (📖 125)
- Sequence display options (📖 129)
- Favorite pictures² (📖 101)
- D-Lighting¹ (📖 133)
- Filter effects¹ (📖 135)
- Print order² (📖 117)
- Protect² (📖 122)
- Small picture¹ (📖 138)
- Copy² (📖 127)
- Choose key picture (📖 129)

¹ Press the **MENU** button after displaying individual images. Settings can be applied to individual images.

² When the **MENU** button is pressed during key picture playback, the same settings can be applied to all images in that sequence. Press the **MENU** button after displaying individual images to apply settings to individual images.

Viewing Multiple Images: Thumbnail Playback

Rotate the zoom control to **W** () in full-frame playback mode ( 89) to display images in “contact sheets” of thumbnail images.



The following operations are available while thumbnails are displayed.

Function	Control	Description	
Choose images		Rotate the rotary multi selector, or press ▲ , ▼ , ◀ or ▶ .	11
Increase the number of images displayed/apply the calendar display	W ()	Rotate the zoom control to W () to increase the number of image thumbnails displayed: 4 → 9 → 16 → 72 → calendar display. Rotate the zoom control to W () with 72 thumbnails displayed to switch to calendar display (except for list by date mode). Rotate the zoom control to W () in the 16-image thumbnail display to apply the calendar display ( 96), and images can be found by the date on which they were captured. Rotate the zoom control to W () to return to thumbnail display.	—
Decrease the number of images displayed	T ()	Rotate the zoom control to T () to decrease the number of image thumbnails displayed: 72 → 16 → 9 → 4. Rotate the zoom control to T () in 4-image thumbnail display to return to full-frame playback mode.	—
Delete images		Select a deletion method and delete images. When using favorite pictures mode ( 101), auto sort mode ( 109), or list by date mode ( 113), images in the same album, category, or shooting date can be deleted.	31

Function	Control	Description	
Switch to full-frame playback mode		Press the  button.	89
Switch to shooting mode		Press the  button or shutter-release button. The  (movie-record) button can also be used to switch to shooting mode.	30
			
			

Thumbnail Playback Mode Display

When images marked using **Print order** ( 117) or **Protect** ( 122) are selected, the icons shown on the right are displayed with them.

The icon shown on the right is displayed when an image in a sequence ( 92) is selected.

Movies are displayed as film frames (If 72-image thumbnails are displayed,  is displayed at the top of the monitor when a movie is selected).

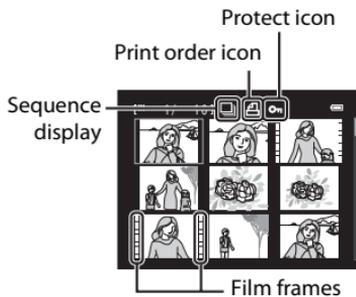

Thumbnail Display in Favorite Pictures Mode and Auto Sort Mode

- In favorite pictures mode ( 101), the icon of the album being played back is displayed at the top right of the monitor.
- In auto sort mode ( 109), the current image's category icon is displayed at the top right of the monitor.



Calendar Display

With playback display of 72 thumbnails (📖 94), rotate the zoom control to **W** (📐) to switch to calendar display (except for list by date mode).

Images can be selected for display based on the date on which they were captured. The dates on which images were captured are underlined in yellow.

The following operations are available in calendar display.



Function	Control	Description	📖
Select date		Rotate the rotary multi selector, or press ▲, ▼, ◀, or ▶.	11
Return to full-frame playback		The first image captured on the selected date is displayed full frame.	89
Return to thumbnail display	T (📐)	Rotate the zoom control to T (📐).	94

✔ Notes on Calendar Display

- Images captured when the camera's date is not set are treated as images captured on January 1, 2011.
- The 🗑️ button and MENU button are not available in calendar display.

📖 List by Date Mode

Only the images captured on the same date can be played back in list by date mode (📖 113). The list by date options (📖 114) are also available only for the images captured on the selected date.

Taking a Closer Look: Playback Zoom

Rotating the zoom control to **T** (📷) in full-frame playback mode (📖 89) enlarges display of the center portion of the current image.

- The guide displayed at bottom right shows the portion of the image currently displayed.

The following operations are available while image display is enlarged.



Function	Control	Description	📖
Zoom in	T (📷)	Zoom increases each time the zoom control is rotated to T (📷), up to about 10x.	–
Zoom out	W (📷)	Zoom decreases each time the zoom control is rotated to W (📷). When the magnification ratio reaches 1x, the display returns to full-frame playback mode.	–
View other areas of image		Press the rotary multi selector ▲, ▼, ◀, or ▶ to move the display area to other areas of the image.	11
Delete images		Select a deletion method and delete images. When using favorite pictures mode (📖 101), auto sort mode (📖 109), or list by date mode (📖 113), images in the same album, category, or shooting date can be deleted.	31
Switch to full-frame playback mode	OK	Press the OK button.	89
Crop image	MENU	Create a cropped copy with only the enlarged portion and save the copy as a separate file.	139
Switch to shooting mode		Press the button or shutter-release button. The (movie-record) button can also be used to switch to shooting mode.	30

Images Captured with Face Detection or Pet Detection

When zooming in (playback zoom) on an image captured using the face detection (📖 56) or pet detection function (📖 74) by rotating the zoom control to **T** (📷), the image will be enlarged with the face detected at the time of shooting at the center of the monitor (except images captured continuously with the **Pet portrait** scene mode (📖 74) or images captured with continuous shooting mode (📖 80)).



- If more than one face was detected, the image will be enlarged with the face on which focus was acquired at the center of the monitor. Press the rotary multi selector ▲, ▼, ◀, or ▶ to display other detected faces.
- Rotate the zoom control toward **T** (📷) again or toward **W** (📷) to zoom in or out as normal.

Playing Back Images by Category

The following playback modes can be selected.

	Play 📖 89
Play back all images.	
	Favorite pictures 📖 101
Play back images added to an album.	
	Auto sort 📖 109
Play back images and movies automatically sorted to the selected category with shooting.	
	List by date 📖 113
Play back images captured on the selected date.	

1 Press the **MENU** button in playback mode.

The playback menu is displayed.

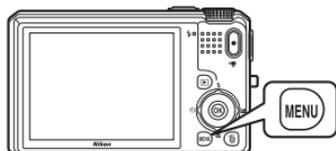

2 Press the rotary multi selector ◀.

Tab selection is activated.

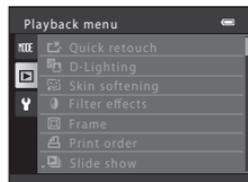

3 Press ▲ or ▼ to choose the **MODE** tab.

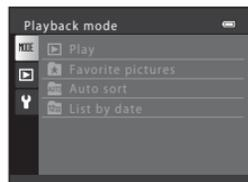

4 Press ▶ or the **OK** button.

The playback-mode selection menu is displayed.

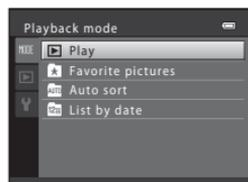

5 Use the rotary multi selector to choose a playback mode.

To return to the current playback mode without switching playback modes, press the **MENU** button.

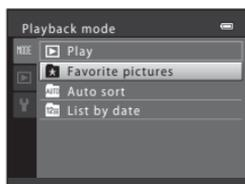

6 Press the **OK** button.

The camera enters the selected playback mode.

Sorting Favorite Images (Favorite Pictures Mode)

Captured images can be added to an album and sorted.

After images are added, they can be easily played back using “ favorite pictures mode.”

- By adding images to an album, images can be easily found.
- Images can be sorted by each event such as vacations or weddings.
- The same image can be added to multiple albums.

Adding Images to an Album

Captured images can be added to an album and sorted.

- 1 Choose an image in playback mode ( 30), auto sort mode ( 109), or list by date mode ( 113) and press the **MENU** button.

The playback menu is displayed.

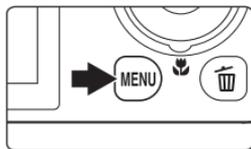

- 2 Use the rotary multi selector to choose  **Favorite pictures** and press the **OK** button.

The favorite pictures screen is displayed.

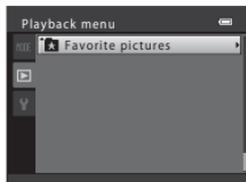

- 3 Rotate the rotary multi selector or press  or , and then choose an image and press  to display .

To add more images to the same album, repeat this step as necessary.

To undo the selection, press  to remove .

Rotate the zoom control ( 4) to **T** () to switch back to full-frame playback or **W** () to display thumbnails.

Press the **OK** button to display the album selection screen.

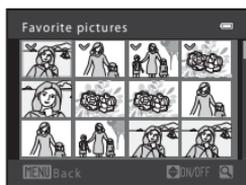

- 4** Use the rotary multi selector to choose the album to which the images will be added and press the **OK** button.

The selected images are added and the camera switches to the playback menu.

To add the same image to multiple albums, repeat from step 3.

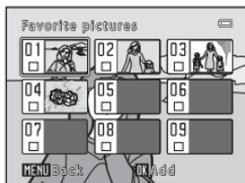

Notes on Favorite Pictures

- Up to 200 images can be added to each album.
- Movies cannot be added to an album.
- If the selected image has been already added to an album,  is displayed in the album's checkbox.
- When images are added to an album, they are not moved from the folder to which they were saved (📖 199) or copied to the album (📖 108).

More Information

See "Removing Images From an Album" (📖 104).

Viewing Images in an Album

When using “ favorite pictures mode”, images added to an album can be displayed by selecting the album.

- In full-frame playback mode, images in the same album can be played back ( 89) and edited ( 130).
- When the **MENU** button is pressed in full-frame playback mode or thumbnail display mode, the favorite pictures menu ( 105) is displayed, and all images added to an album can be selected for viewing in a slide show, or applying print order or protection settings.

- 1 Press the **MENU** button during playback, select the **MODE** (playback mode) tab, and then press  or the **OK** button ( 99).

The playback-mode selection menu is displayed.

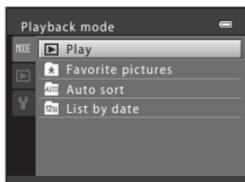
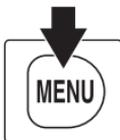

- 2 Use the rotary multi selector to choose , and press the **OK** button.

A list of albums is displayed.

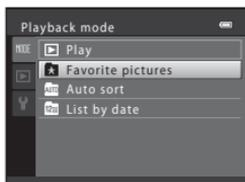

- 3 Use the rotary multi selector to choose an album.

For information about operating the list of albums screen, see  105.

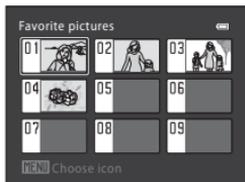

When the **OK** button is pressed, an image in the selected album is displayed full frame.

The icon of the album currently being played back is displayed at the top right of the monitor.

Repeat steps 1 and 2 to select a different album.



Removing Images From an Album

Remove images from an album without deleting the images.

- 1 Select the album from which images will be removed, play back images in that album (📖 103), and then press the **MENU** button.

The playback menu is displayed.

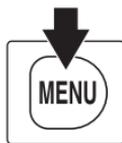

- 2 Use the rotary multi selector to choose **Remove from favorites** and press the **OK** button.

The remove from favorites screen is displayed.

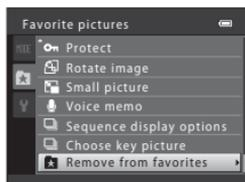

- 3 Rotate the rotary multi selector or press **◀** or **▶**, and then choose an image and press **▲** to display **✔**.

To remove more images from the same album, repeat this step as necessary.

To undo the selection, press **▼** to remove **✔**.

Rotate the zoom control (📖 4) to **T** (🔍) to switch back to full-frame playback or **W** (📑) to display thumbnails.

Press the **OK** button when selection is complete.



- 4 Choose **Yes** and press the **OK** button.

The image is removed from the album.

To cancel removal, select **No**.

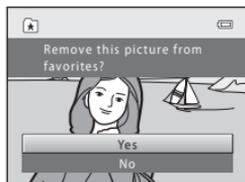

✔ Note on Deletion

If an image is deleted while using favorite pictures mode, the image will be removed from the album and it will be permanently deleted from the internal memory or the memory card (📖 108).

Using Favorite Pictures Mode

The following operations are available from the list of albums screen (📖 103 step 3).

Function	Control	Description	📖
Choose an album		Rotate the rotary multi selector, or press ▲, ▼, ◀, or ▶.	11
Switch to full-frame playback mode		Images in the selected album are displayed full frame.	89
Delete images		All images added to the selected album are deleted. Choose Yes when the confirmation dialog is displayed.	31
Change the album icon	MENU	Change the album icon.	106
Switch to shooting mode		Press the  button or shutter-release button. The  (▶ movie-record) button can also be used to switch to shooting mode.	30
			
			

More on Playback

Favorite Pictures Menu

Press the **MENU** button in full-frame playback mode or thumbnail playback mode in favorite pictures mode to apply the following menu operations.

Quick retouch	→📖 132	D-Lighting	→📖 133
Skin softening	→📖 134	Filter effects	→📖 135
Frame	→📖 137	Print order	→📖 117
Slide show	→📖 121	Protect	→📖 122
Rotate image	→📖 124	Small picture	→📖 138
Voice memo	→📖 125	Sequence Display Options	→📖 129
Choose Key Picture	→📖 129	Remove from favorites	→📖 104

Changing the Album Icons

The design of the album icons can be changed. By changing the icons, it will be easier to identify what kind of images are added to each album.

- 1 Press the **MENU** button during playback, choose the **MODE** (playback mode) tab, and then press **▶** or the **OK** button (📖 99).

The playback-mode selection menu is displayed.

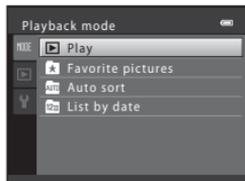
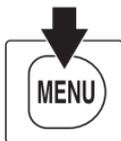

- 2 Use the rotary multi selector to choose **Favorite pictures**, and press the **OK** button.

A list of albums is displayed.

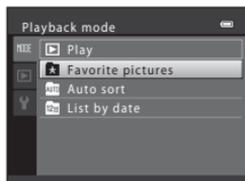

- 3 Use the rotary multi selector to choose an album and press the **MENU** button.

The choose icon screen is displayed.

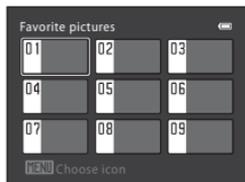
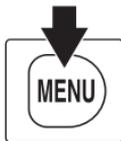

- 4 Press **◀** or **▶** to choose an icon color and press the **OK** button.



- 5 Press **▲**, **▼**, **◀**, or **▶** to choose an icon and press the **OK** button.

The icon changes and the monitor display returns to the list of albums screen.



Notes on Album Icons

Set the album icons separately for the internal memory and for the memory card.

- To change the album icons for the internal memory, first remove the memory card from the camera.
- The default setting for the icon is the number icon (black).

Sorting Favorite Images (Favorite Pictures Mode)

Adding/Playing Favorite Pictures

When images are added to an album, they are not moved from the folder to which they were saved (📁 199) or copied to the album. Only the file names of the images are added to the album. When using favorite pictures mode, images are played back by retrieving the images that correspond to the file names added to the albums.

Note that if an image is deleted while using favorite pictures mode (📁 31, 105), the image will be removed from the album and it will be permanently deleted from the internal memory or the memory card.

Adding Pictures to Albums

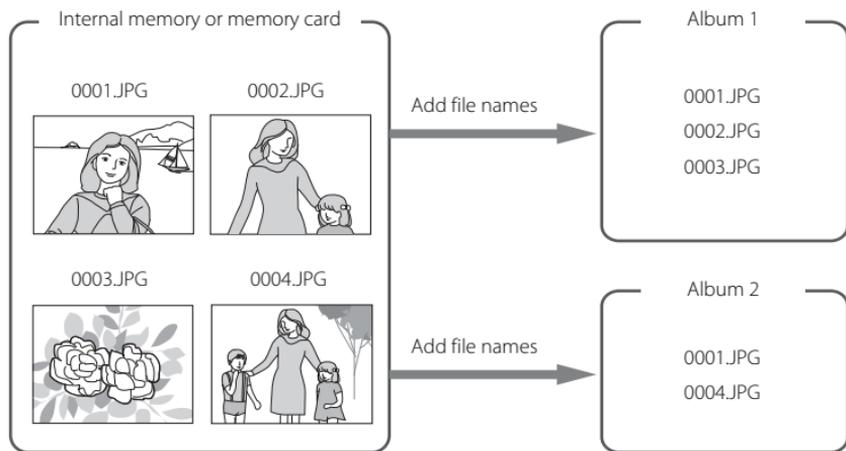

More on Playback

Viewing Pictures in Albums

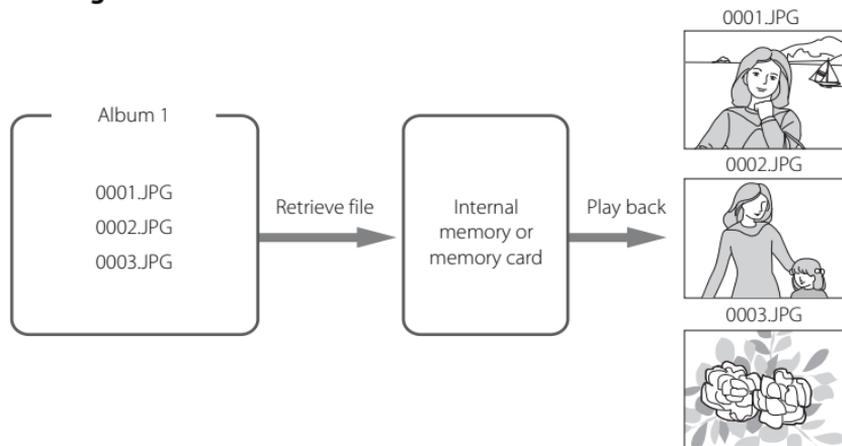

Finding Images in Auto Sort Mode

Images and movies are automatically sorted to one of the following categories with shooting. When “**AUTO** auto sort mode” is selected, images and movies can be viewed by selecting the category to which they were sorted.

Smile	Portraits	Food
Landscape	Dusk to dawn	Close-ups
Pet portrait	Movie	Retouched copies
Other scenes		

- In full-frame playback mode, images in the same category can be played back (📖 89) and edited (📖 130). Images can be also sorted into albums.
- When the **MENU** button is pressed, the auto sort menu (📖 112) is displayed, and all images in the same category can be selected for viewing in a slide show, or applying print order or protection settings.

Viewing Images in Auto Sort Mode

- 1 Press the **MENU** button during playback, choose the **MODE** (playback mode) tab, and then press **▶** or the **OK** button (📖 99).

The playback-mode selection menu is displayed.

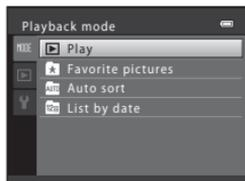
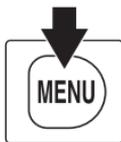

- 2 Use the rotary multi selector to choose **AUTO**, and press the **OK** button.

A list of categories is displayed.

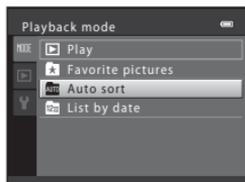

3 Use the rotary multi selector to choose a desired category.

For information about categories, see “Auto Sort Mode Categories” (📖 111).

For information about operating the auto sort mode screen, see “Operations in Auto Sort Mode” (📖 112).

Press the **OK** button to display an image in the selected category in full-frame playback mode.

The icon of the category currently played back will be displayed at the top right of the screen.

Repeat steps 1 and 2 to select a different category.



Auto Sort Mode Categories

Category	Description
 Smile	Images captured using smile timer (📖 37).
 Portraits	Images captured in  (auto) mode (📖 24) and continuous shooting mode (📖 80) using face detection (📖 56). Images captured in the following scene modes. <ul style="list-style-type: none">  (night portrait)* (📖 65)  (backlighting)* (📖 66) Portrait* (📖 67), Party/indoor (📖 68)
 Food	Images captured in the Food (📖 71) scene mode.
 Landscape	Images captured in the Landscape* (📖 67) scene mode.
 Dusk to dawn	Images captured in the following scene modes. <ul style="list-style-type: none">  (night landscape)* (📖 64) Sunset (📖 69), Dusk/dawn (📖 70), Fireworks show (📖 72)
 Close-ups	Images captured in  (auto) mode and continuous shooting mode (📖 80) with macro mode set (📖 39). Images captured in the Close-up* (📖 70) scene mode.
 Pet portrait	Images captured in the Pet portrait (📖 74) scene mode.
 Movie	Movies (📖 140).
 Retouched copies	Copies created using editing function (📖 130).
 Other scenes	All other images that cannot be defined by the categories described above.

* Images captured in scene auto selector (📖 62) are also sorted to the appropriate categories.

Notes on Auto Sort Mode

- Up to 999 images and movie files can be sorted to each category in auto sort mode. If 999 images or movies have already been sorted to a specific category, new images and movies cannot be sorted to that category nor can they be displayed in auto sort mode. Display images and movies that could not be sorted to a category in normal playback mode (📖 30) or list by date mode (📖 113).
- Images or movies copied from the internal memory to a memory card, or vice versa (📖 127), cannot be displayed in auto sort mode.
- Images or movies saved by a camera other than the COOLPIX S9100 cannot be displayed in auto sort mode.

Operations in Auto Sort Mode

The following operations are available in the category list screen (📖 110 step 3).

Function	Control	Description	📖
Select a category		Rotate the rotary multi selector, or press ▲, ▼, ◀, or ▶.	11
Switch to full-frame playback mode		Display images in the selected category in full-frame playback mode.	89
Delete images		Delete all images in the selected category. Choose Yes when the confirmation dialog is displayed.	31
Switch to shooting mode		Press the  button or shutter-release button. The  (movie-record) button can also be used to switch to shooting mode.	30
			
			

More on Playback

Auto Sort Menu

Press the **MENU** button in full-frame playback mode or thumbnail playback mode in auto sort mode to operate the following menus.

Quick retouch	→📖 132	D-Lighting	→📖 133
Skin softening	→📖 134	Filter effects	→📖 135
Frame	→📖 137	Print order	→📖 117
Slide show	→📖 121	Protect	→📖 122
Rotate image	→📖 124	Small picture	→📖 138
Voice memo	→📖 125	Sequence Display Options	→📖 129
Choose Key Picture	→📖 129	Favorite pictures	→📖 101

Viewing Images by Date (List by Date)

In “ list by date mode”, only images captured on the same date can be played back.

- In full-frame playback mode, just as with normal playback mode, shooting information can be displayed, image display can be enlarged, images can be edited, and movies can be played back. Images can be also sorted into albums.
- When the **MENU** button is pressed, the list by date menu ( 114) is displayed, and all images captured on the same date can be selected for viewing in a slide show, or applying print order or protection settings.

Viewing Images in List by Date Mode

- 1** Press the **MENU** button during playback, choose the **MODE** (playback mode) tab, and then press  or the **OK** button ( 99).

The playback-mode selection menu is displayed.

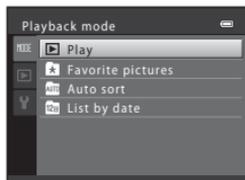
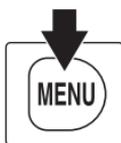

- 2** Use the rotary multi selector to choose , and press the **OK** button.

The list by date screen is displayed.

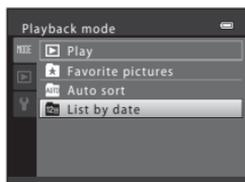

- 3** Use the rotary multi selector to choose a date.

The camera lists up to 29 dates. If images exist for more than 29 dates, all images saved earlier than most recent 29 dates will be combined under **Others**.

For information about operating the list by date screen, see “Operations in List by Date Mode” ( 114).

When the **OK** button is pressed, the first image captured on the selected date will be displayed full frame.

Repeat steps 1 and 2 to select a different shooting date.



Notes on List by Date Mode

- The 9,000 most recent images can be displayed in list by date mode. If more than 9,000 images are saved, “*” is displayed for the date containing the 9,001st image.
- Images captured when the camera’s date is not set are treated as images captured on January 1, 2011.

Operations in List by Date Mode

The following operations are available in the list by date screen (📖 113 step 3).

Function	Control	Description	📖
Select date		Rotate the rotary multi selector, or press ▲ or ▼.	11
Switch to full-frame playback mode		Display images captured on the selected date in full-frame playback mode.	89
Delete images		Delete all images captured on the selected date. Choose Yes when the confirmation dialog is displayed.	31
View list by date menu	MENU	Press the MENU button to display the list by date menu.	–
Switch to shooting mode		Press the  button or shutter-release button. The ● (▶ movie-record) button can also be used to switch to shooting mode.	30
			
			

More on Playback

List by Date Menu

Press the **MENU** button in list by date mode to apply one of the following menu operations to images captured on the selected date.

Quick retouch ¹	→📖 132	D-Lighting ¹	→📖 133
Skin softening ¹	→📖 134	Filter effects ¹	→📖 135
Frame ¹	→📖 137	Print order ²	→📖 117
Slide show	→📖 121	Protect ²	→📖 122
Rotate image ¹	→📖 124	Small picture ¹	→📖 138
Voice memo ¹	→📖 125	Sequence Display Options	→📖 129
Choose Key Picture	→📖 129	Favorite pictures ¹	→📖 101

¹ After displaying the image in full-frame playback mode, press the **MENU** button.

² When the **MENU** button is pressed in the list by date screen (📖 113 step 3), options can be applied to all images captured on the selected date. When the **MENU** button is pressed in full-frame playback mode, options can be applied to individual images.

Playback Options: Playback Menu

The following options are available in the playback menu.

 Quick retouch  132	Easily create retouched copies in which contrast and saturation have been enhanced.
 D-Lighting  133	Enhance brightness and contrast in dark portions of images.
 Skin softening  134	Make facial skin tones softer.
 Filter effects  135	Filter effects (digital filter) can be used to apply a variety of effects to images.
 Frame  137	Create a copy of an image that is surrounded by a frame. 12 different frames are available.
 Print order  117	Select images to print and the number of copies for each.
 Slide show  121	View images saved in the internal memory or on a memory card in an automatic slide show.
 Protect  122	Protect selected images from accidental deletion.
 Rotate image  124	Change the orientation of images.
 Small picture  138	Create a small copy of the current image.
 Voice memo  125	Record voice memos for images.
 Copy  127	Copy files between the internal memory and a memory card.
 Sequence display options  129	Display a sequence of images shot continuously as individual images, or display only the key picture of a sequence.

Choose key picture 129

Change the key picture that is displayed to represent a series of images shot continuously (sequence →  92).

Favorite pictures 101

Select and add images as favorites.

Remove from favorites 104

Remove an image from an album.

Displaying the Playback Menu

Press the  button to enter playback mode ( 89).

Press the **MENU** button to display the playback menu.

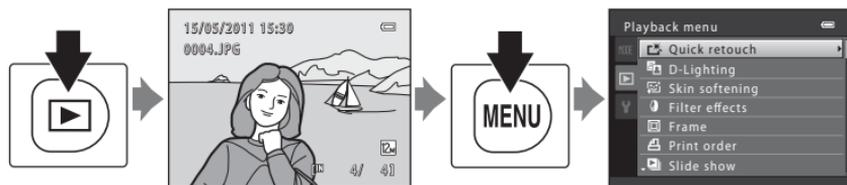

- Use the rotary multi selector to choose and apply settings ( 11).
- Press the **MENU** button to exit the playback menu.
- Select the **MODE** (playback mode) tab to switch the playback mode ( 99).

Print Order (Creating a DPOF Print Order)

▶ button (Playback mode) → MENU (Playback menu) → Print order

When printing images saved on the memory card using any of the following methods, the **Print order** option in the playback menu is used to create digital “print orders” for printing on DPOF-compatible devices.

- Inserting the memory card into a DPOF-compatible (📖 215) printer’s card slot
- Taking the memory card to a digital photo lab.
- Connecting the camera to a PictBridge-compatible (📖 215) printer (📖 163). A print order can also be created for images saved in the internal memory if the memory card is removed from the camera.

1 Press the MENU button in playback mode.

The playback menu is displayed.

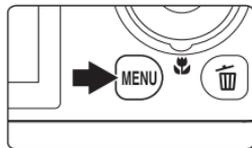

2 Use the rotary multi selector to choose **Print order** and press the OK button.

Proceed to step 4 when playing back in favorite pictures mode, auto sort mode, or list by date mode.

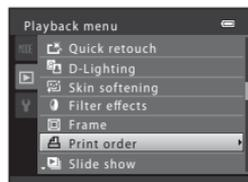

3 Choose **Select images** and press the OK button.

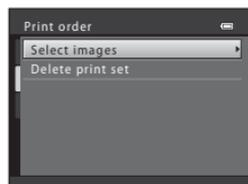

4 Choose images (up to 99) and the number of copies (up to nine) of each.

Rotate the rotary multi selector, or press ◀ or ▶ to select images, and press ▲ or ▼ to specify the number of copies to be printed.

Image selected for printing can be identified by the check mark (✓) and the numeral indicating the number of copies to be printed. If no copies have been specified for images, the selection is canceled.

Rotate the zoom control to **T** (Q) to switch to full-frame playback. Rotate the zoom control to **W** (E) to switch back to 12-thumbnail display.

Press the **OK** button when setting is complete.



5 Choose whether or not to print shooting date and shooting information.

Choose **Date** and press the **OK** button to print the shooting date on all images.

Choose **Info** and press the **OK** button to print shooting information (shutter speed and aperture) on all images.

Choose **Done** and press the **OK** button to apply the settings.

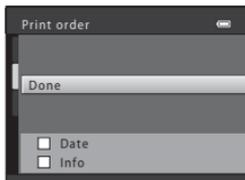

Images selected for printing can be identified by the  icon displayed with playback.



✓ Notes on Print Order

When a print order is created in favorite pictures mode, auto sort mode, or list by date mode, the screen shown below is displayed if images other than those in the selected album, category, or shooting date have been marked for printing.

- If **Yes** is selected, the current print order settings are added to the print order settings of other images.
- If **No** is selected, all print order settings of other images are removed and only the current print order settings remain.

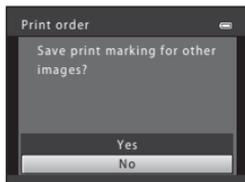

Favorite pictures mode
or auto sort mode

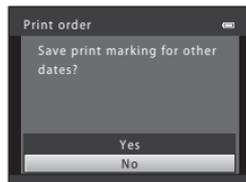

List by date mode

Additionally, if there are more than 99 images as a result of adding the current print order settings, the screen shown below will be displayed.

- If **Yes** is selected, all print order settings of other images are removed and only the current print order settings remain.
- If **Cancel** is selected, the print order settings of other images remain and the current print order settings are removed.



Favorite pictures mode
or auto sort mode

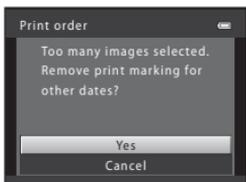

List by date mode

✔ Notes on Printing Shooting Date and Shooting Information

When the **Date** and **Info** settings are enabled in the print order option, shooting date and shooting data are printed on images when a DPOF-compatible (📖 215) printer that supports printing of shooting date and shooting data is used.

- Shooting information cannot be printed when the camera is connected directly to a printer, via the supplied USB cable, for DPOF printing (📖 168).
- Note that **Date** and **Info** settings are reset each time the **Print order** option is displayed.
- The date printed is that saved when the image was captured. Changing the camera's date using the **Date and time** or **Time zone** in the **Time zone and date** option in the setup menu after an image has been captured has no effect on the date printed on the image.



✂ Canceling Existing Print Order

Select **Delete print set** in step 3 of "🖨 Print Order (Creating a DPOF Print Order)" (📖 117) and press the **OK** button to remove printing marking from all images and cancel the print order.

🕒 Print Date

When shooting date and time are imprinted on images using the **Print date** option (📖 177) in setup menu, images are saved with shooting date and time imprinted on the image when they are captured. Images with the date imprinted on them can be printed from printers that do not support printing of the date on images.

If the **Print date** option is used to imprint the shooting date on images, the **Date** selection option of the **Print order** function has no effect.

Slide Show

 button (Playback mode) → MENU (Playback menu) →  Slide show

Play back images, saved in the internal memory or on a memory card, one by one in an automated “slide show.”

1 Use the rotary multi selector to choose **Start** and press the **OK** button.

To change the interval between images, choose **Frame intvl**, select the desired interval time, and press the **OK** button before choosing **Start**.

To repeat the slide show automatically, choose **Loop** and press the **OK** button before choosing **Start**. The check mark (✓) will be added to the loop option when enabled.

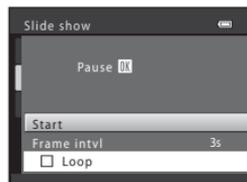

2 The slide show begins.

While the slide show is in progress, press the rotary multi selector  to display the next image or  to display the previous image. Hold down either button to fast forward or rewind.

To end or pause the slide show, press the **OK** button.



3 End the slide show or restart it.

The screen shown on the right is displayed when the slide show has ended or is paused. Choose **End** and press the **OK** button to return to the playback menu. Choose **Restart** to play the slide show again.

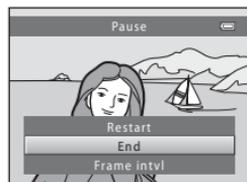

Notes on Slide Show

- Only the first frame of movies is displayed.
- For sequences ( 92) whose sequence display options are set to **Key picture only**, only the key picture is displayed.
- Images captured using easy panorama ( 73, 75) cannot be played in a slide show.
- The maximum playback time is up to 30 minutes even if **Loop** is enabled ( 184).

Protect

 button (Playback mode) → MENU (Playback menu) →  Protect

Protect selected images from accidental deletion.

Select images to protect or cancel protection for previously protected images from the image selection screen. See “Selecting Images” ( 123) for more information.

Note that formatting the camera’s internal memory or the memory card will permanently delete protected images ( 185).

Protected images can be identified by the  icon in playback mode ( 8, 95).

Selecting Images

When using one of the following features, a screen like that shown on the right is displayed when selecting images.

- Print order > **Select images** (📖 117)
- Protect (📖 122)
- Rotate image (📖 124)
- Copy > **Selected images** (📖 127)
- Choose key picture (📖 129)
- Favorite pictures (📖 101)
- Remove from favorites (📖 104)
- Welcome screen > **Select an image** (📖 171)
- Delete image > **Erase selected images** (📖 31)



Follow the procedures described below to choose the images.

1 Rotate the rotary multi selector, or press ◀ or ▶ to choose the desired image.

Rotate the zoom control (📖 4) to **T** (🔍) to switch to full-frame playback or **W** (📐) to switch back to 12-thumbnailed display.

Only one image can be selected for **Rotate image**, **Choose key picture**, and **Welcome screen**. Proceed to step 3.



2 Press ▲ or ▼ to select or deselect (or to specify the number of copies).

When an image is selected, a check mark (☑) is displayed with the image. Repeat steps 1 and 2 to select additional images.



3 Press the Ⓞ button to apply image selection.

When **Selected images** is selected, a confirmation dialog is displayed. Follow the instructions displayed in the monitor.

Rotate Image

 button (Playback mode) → MENU (Playback menu) →  Rotate image

Specify the orientation in which saved images are displayed with playback. Still images can be rotated 90 degrees clockwise or 90 degrees counterclockwise. Images that were saved in portrait (“tall”) orientation can be rotated up to 180 degrees in either direction.

Select an image from the image selection screen ( 123). When the Rotate image screen is displayed, rotate the rotary multi selector or press ◀ or ▶ to rotate the image 90 degrees.

More on Playback

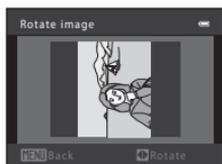

Rotate 90 degrees
counterclockwise



Rotate 90 degrees
clockwise



Press the  button to finalize display orientation, and save orientation information with the image.

Rotating Images in a Sequence

While the key picture of a sequence is displayed, images cannot be rotated. Apply the setting after displaying individual images ( 92, 129).

Voice Memo

 button (Playback mode) → MENU (Playback menu) →  Voice memo

Use the camera's microphone to record voice memos for images.

Recording Voice Memos

- 1 Choose an image in full-frame playback mode ( 89) or thumbnail playback mode ( 94) and press the **MENU** button.

The playback menu is displayed.

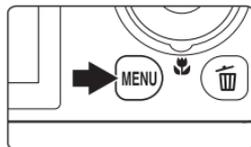

- 2 Use the rotary multi selector to choose  **Voice memo** and press the **OK** button.

The screen for recording voice memos is displayed.

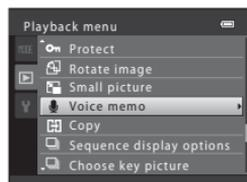

- 3 Press and hold the **OK** button to record a voice memo.

Recording ends after about 20 seconds or when the **OK** button is released.

Do not touch the microphone during recording.

During recording, **REC** and  blink in the monitor.

When recording ends, the voice memo playback screen is displayed. Follow the procedure in step 3 of "Playing Voice Memos" ( 126) to play the voice memo.

Press the rotary multi selector  before or after recording a voice memo to return to the playback menu. Press the **MENU** button to exit the playback menu.



More Information

See "File and Folder Names" ( 199) for more information.

Playing Voice Memos

Images for which voice memos have been recorded are indicated by  in full-frame playback mode.

- 1 Choose an image in full-frame playback mode ( 89) or thumbnail playback mode ( 94) and press the **MENU** button.

The playback menu is displayed.

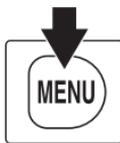

- 2 Use the rotary multi selector to choose  **Voice memo** and press the **OK** button.

The voice memo playback screen is displayed.

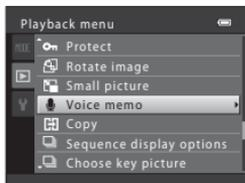

- 3 Press the **OK** button to play the voice memo.

Press the **OK** button again to stop playback.

Rotate the zoom control to **T** or **W** during playback to adjust playback volume.

Press the rotary multi selector  before or after playing a voice memo to return to the playback menu. Press the **MENU** button to exit the playback menu.



Deleting Voice Memos

Select an image with a voice memo and press the  button. Rotate the rotary multi selector or press  or  to choose **Current image**, and press the **OK** button ( 31). When the confirmation dialog is displayed, press the rotary multi selector  or  to choose  and press the **OK** button. Only the voice memo will be deleted.



Notes on Voice Memos

- When an image with a voice memo attached is deleted, both the image and its voice memo are deleted.
- Voice memos cannot be recorded for an image that already has a voice memo attached on it. The current voice memo must be deleted before a new voice memo can be recorded.
- The COOLPIX S9100 is not able to record a voice memo for images captured with another make or model of digital camera.

Copy (Copy Between Internal Memory and Memory Card)

▶ button (Playback mode) → MENU (Playback menu) → Copy

Copy images between the internal memory and a memory card.

- 1 Use the rotary multi selector to choose a destination option to which images are copied and press the **OK** button.

 → : Copy images from internal memory to memory card. This option is not available if an image that is in a sequence group was selected before the playback menu was displayed.

 → : Copy images from memory card to internal memory.

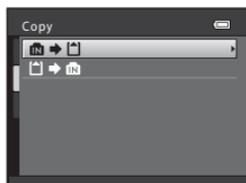

- 2 Select a copy option and press the **OK** button.

Selected images: Copy images selected from the image selection screen (📖 123). If a sequence for which only a key picture is displayed is selected (📖 92), all images in the displayed sequence are copied.

All images: Copy all images. If an image in a sequence is selected, this option is not displayed.

Current sequence: This option is available only if an image that is in a sequence group was selected before the playback menu was displayed. All images in the current sequence are copied.

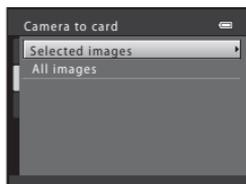

Notes on Copying Images

- JPEG-, MOV-, and WAV-format files can be copied. Files saved in any other format cannot be copied.
- If voice memos (📖 125) are attached to images selected for copying, voice memos are copied with the images.
- Operation is not guaranteed with images captured with another make of camera or that have been modified on a computer.
- When copying images for which **Print order** (📖 117) options are enabled, the print order settings are not copied. However, when copying images for which **Protect** (📖 122) is enabled, the protect setting is copied.
- Images or movies copied from the internal memory or a memory card cannot be displayed in auto sort mode (📖 109).
- Even if images added to an album (📖 101) are copied, the contents of the album will not be copied.
- If **Sequence display options** (📖 129) is set to **Key picture only** and an image in the sequence is selected and the  button is pressed to display individual images (📖 92), only    (memory card to internal memory) image copy is available.

Memory contains no images. Message

If there are no images saved on a memory card inserted in the camera when playback mode is applied, the message **Memory contains no images.** will be displayed. Press the **MENU** button to display the copy option screen, and copy the images saved in the camera's internal memory to the memory card.

More Information

See "File and Folder Names" (📖 199) for more information.

Sequence Display Options

 button (Playback mode) → MENU (Playback menu) →  Sequence display options

Choose the method used to display a series of images shot continuously (sequence →  92) when viewing them in full-frame playback mode ( 89) and in thumbnail playback mode ( 94).

Settings are applied to all sequences, and the setting is saved in the camera's memory even if the camera is turned off.

Individual pictures

Set all images in all sequences to be displayed individually.

Key picture only (default setting)

Set all sequences to be displayed using their key pictures only.

Choose Key Picture

 button (Playback mode) → MENU (Playback menu) →  Choose key picture

When **Sequence display options** is set to **Key picture only**, the key picture displayed in full-frame playback mode ( 89) and thumbnail playback mode ( 94) can be set for each sequence of images.

- When changing this setting, before pressing **MENU**, first select the desired sequence using full-frame playback mode and thumbnail playback mode.
- When the key picture selection screen is displayed, select an image. See “Selecting Images” ( 123) for more information.

Editing Functions

Use the COOLPIX S9100 to edit images in-camera and save them as separate files (📖 199). The editing functions described below are available.

Editing function	Description
Quick retouch (📖 132)	Easily create retouched copies in which contrast and saturation have been enhanced.
D-Lighting (📖 133)	Create a copy of the current image with enhanced brightness and contrast, brightening dark portions of the image.
Skin softening (📖 134)	Make facial skin tones softer.
Filter effects (📖 135)	Filter effects (digital filter) can be used to apply a variety of effects to images. Effect types include Soft , Selective color , Cross screen , Fisheye , and Miniature effect .
Frame (📖 137)	Create a copy of an image that is surrounded by a frame. 12 different frames are available.
Small picture (📖 138)	Create a small copy of images suitable for use as e-mail attachments.
Crop (📖 139)	Crop a portion of the image. Use to zoom in on a subject or arrange a composition.

✓ Notes on Image Editing

- Images captured at an **Image mode** setting of **HD 3968×2232** (📖 47) cannot be edited. Still images captured while recording high-definition or full high-definition movies also cannot be edited (📖 142).
- Images captured using easy panorama (📖 73, 75) cannot be edited.
- The editing functions of the COOLPIX S9100 cannot be used for images captured with another make or model of digital camera.
- If no face is detected in an image, a copy cannot be created using the skin softening function (📖 134).
- Images captured at an **Image mode** (📖 47) setting of **PC 1024×768** or **VM 640×480** cannot be edited using **Frame** (📖 137).
- Edited copies created with the COOLPIX S9100 may not be displayed properly on another make or model of digital camera. It may also be impossible to transfer them to a computer using another make or model of digital camera.
- Editing functions are not available when there is not enough free space in the internal memory or on the memory card.
- For sequences for which only a key picture is displayed (📖 92), perform one of the following operations before editing.
 - Press **OK** button to display individual images, and then select an image in the sequence
 - Set **Sequence display options** (📖 129) to **Individual pictures** so that each image is displayed individually, and then select an image

Restrictions on Image Editing

When an edited copy is further modified with another editing function, check the following restrictions.

Editing function used	Editing function to add
Quick retouch D-Lighting Filter effects	The skin softening, small picture, frame, or crop function can be added. The quick retouch, D-Lighting, and filter effects functions cannot be used together.
Skin softening	The quick retouch, D-Lighting, filter effects, frame, small picture, or crop function can be added.
Frame Small picture	Another editing function cannot be added.
Crop	Images with an image size of  (2272 × 1704) or higher can be edited using the frame editing function.

- Copies created with editing functions cannot be further edited with the same function used to create them.
- When combining the frame or small picture function and another editing function, use the frame or small picture function after other editing functions have been applied.
- When combining the crop function with any editing function other than frame, use the crop function after other editing functions have been applied.
- Skin softening can also be applied to images captured with the skin softening function ( 67).

Original and Edited Images

- Copies created with editing functions are not deleted if the original images are deleted. The original images are not deleted if copies created with editing functions are deleted.
- Edited copies are saved with the same shooting date and time as the original.
- Print order ( 117) and protect settings ( 122) do not remain effective in edited copies.

Image Editing

Quick Retouch: Enhancing Contrast and Saturation

Quick retouch can be used to easily create retouched copies in which contrast and saturation have been enhanced. Copies created with the quick retouch function are saved as separate files.

- 1 Choose the desired image in full-frame playback mode ( 89) or thumbnail playback mode ( 94) and press the **MENU** button.

The playback menu is displayed.

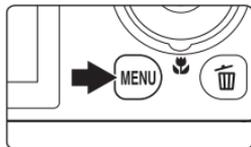

- 2 Use the rotary multi selector to choose  **Quick retouch** and press the **OK** button.

The original version is displayed on the left and the edited version is displayed on the right.

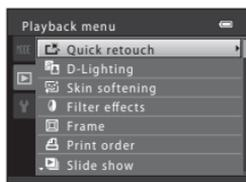

- 3 Press the rotary multi selector  or  to choose the degree of enhancement performed and press the **OK** button.

A new, edited copy is created.

To exit without saving the copy, press the **MENU** button.

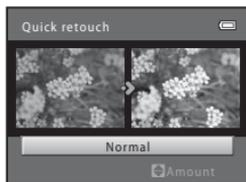

Copies created with the quick retouch function can be identified by the  icon displayed in playback mode.

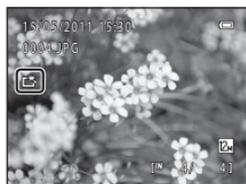

More Information

See "File and Folder Names" ( 199) for more information.

D-Lighting: Enhancing Brightness and Contrast

D-Lighting can be used to create copies with enhanced brightness and contrast, brightening dark portions of an image. Enhanced copies are saved as separate files.

- 1 Choose the desired image in full-frame playback mode ( 89) or thumbnail playback mode ( 94) and press the **MENU** button.

The playback menu is displayed.

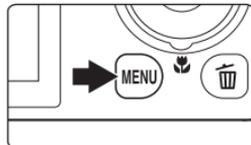

- 2 Use the rotary multi selector to choose  **D-Lighting** and press the **OK** button.

The original version is displayed on the left and the edited version is displayed on the right.



- 3 Choose **OK** and press the **OK** button.

A new, edited copy is created.

To exit without saving the copy, choose **Cancel** and press the **OK** button.



Copies created with the D-Lighting function can be identified by the  icon displayed in playback mode.



More Information

See "File and Folder Names" ( 199) for more information.

Skin Softening: Softening Skin Tones

The camera detects faces in images and creates a copy with softer facial skin tones. Copies created using the skin softening function are saved as separate files.

- 1 Choose the desired image in full-frame playback mode ( 89) or thumbnail playback mode ( 94) and press the **MENU** button.

The playback menu is displayed.

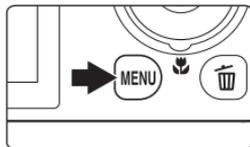

- 2 Use the rotary multi selector to choose  **Skin softening** and press the **OK** button.

The screen for selecting the degree of softening is displayed.

If no faces are detected in the image, an alert is displayed and the camera returns to the playback menu.

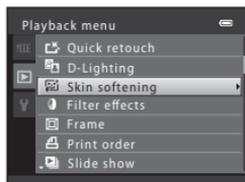

- 3 Press the rotary multi selector **▲** or **▼** to choose the degree of softening and press the **OK** button.

The confirmation dialog is displayed with the face to which skin softening was applied enlarged at the center of the monitor.

To exit without saving the copy, press the **MENU** button.

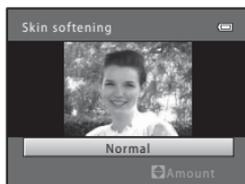

- 4 Check the preview of the copy.

Skin tones in up to 12 faces, in the order of that closest to the center of the frame, are softened.

If more than one face was softened, press the rotary multi selector **◀** or **▶** to display a different face.

Press the **MENU** button to adjust the degree of softening. The monitor display returns to that shown in step 3.

When the **OK** button is pressed, a new, edited copy is created.

Copies created with the skin softening function can be recognized by the  icon displayed in playback mode.



Note on Skin Softening

Depending upon the direction in which faces are looking, or the brightness of faces, the camera may be unable to accurately recognize faces, or the skin softening function may not perform as expected.

More Information

See "File and Folder Names" ( 199) for more information.

Filter Effects (Digital Filter)

Filter effects (digital filter) can be used to apply a variety of effects to images. The following effects are available. Copies created with the filter effects function are saved as separate files.

Type	Description
Soft	Soften the image by adding a slight blur around the outer edges of the image.
Selective color	Keep one specified color in the image, and change the other colors to black and white.
Cross screen	Produce star-like rays of light that radiate outward from bright objects such as sunlight reflections or city lights. This effect is suitable for night scenes.
Fisheye	Make an image look as if it were captured with a fisheye lens. This effect is well-suited for images captured in macro mode.
Miniature effect	Make an image look like a miniature scene captured in macro mode. This effect is well-suited for images captured from a high vantage point with the main subject at the center of the image.

- 1 Choose an image in full-frame playback mode (📖 89) or thumbnail playback mode (📖 94) and press the **MENU** button.

The playback menu is displayed.

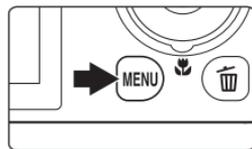

- 2 Use the rotary multi selector to choose **Filter effects** and press the **OK** button.

The screen for selecting the desired filter effect is displayed.

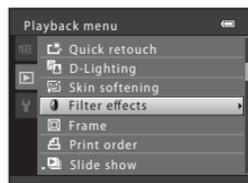

- 3 Press the rotary multi selector **▲** or **▼** to choose an effect, and press the **OK** button.

Change the setting and press the **MENU** button.

When **Cross screen**, **Fisheye**, or **Miniature effect** is selected → step 5

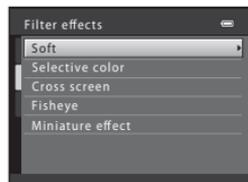

4 Adjust the effect.

Soft: Press ▲ or ▼ to choose the range of the effect and press the **OK** button.

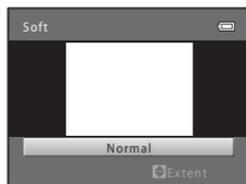

Selective color: The slider is displayed. Rotate the rotary multi selector or press ▲ or ▼ to select the color to be retained, and press the **OK** button.



Slider

5 Confirm the effect, choose **Save**, and press the **OK** button.

A new, edited copy is created.

To exit without saving the copy, choose **Cancel** and press the **OK** button.

Copies created using the filter effects function can be identified by the  icon displayed in playback mode.

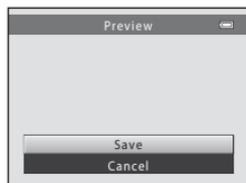

More Information

See "File and Folder Names" ( 199) for more information.

☐ Frame (Adding Frames to Images)

A frame can be added to the outside of an image. There are four frames for horizontal images, four frames for vertical images, and four frames that can be used for both horizontal and vertical images. Copies created with this function are saved as separate files. Copies are saved at an image size of **3M** (2048 × 1536).

- 1 Choose the desired image in full-frame playback mode (📖 89) or thumbnail playback mode (📖 94) and press the **MENU** button.

The playback menu is displayed.

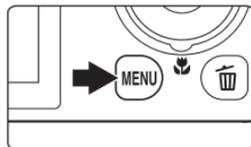

- 2 Use the rotary multi selector to choose **☐ Frame** and press the **OK** button.

The screen for selecting the desired frame is displayed.

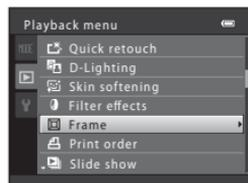

- 3 Press **▲** or **▼** to choose a frame and press the **OK** button.

A new image with the effect applied is created.

To exit without saving the copy, press the **MENU** button.

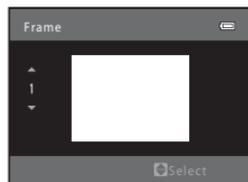

✔ Note on Frame

When a framed image is printed using borderless printing, the frame may not be printed in some situations.

🔍 More Information

See "File and Folder Names" (📖 199) for more information.

Small Picture: Decreasing Image Size

Create a small copy of the current image. This feature is useful for creating copies for display on Web pages or e-mail attachments. The  **640×480**,  **320×240**, and  **160×120** sizes are available. Small copies are saved as separate files with a compression ratio of 1:16.

- 1 Choose the desired image in full-frame playback mode ( 89) or thumbnail playback mode ( 94) and press the **MENU** button.

The playback menu is displayed.

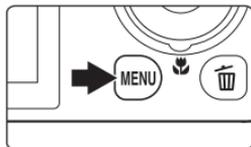

- 2 Use the rotary multi selector to choose  **Small picture** and press the **OK** button.

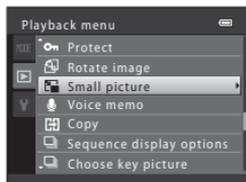

- 3 Choose the desired copy size and press the **OK** button.

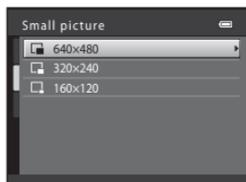

- 4 Choose **Yes** and press the **OK** button.

A new, small copy is created.

To exit without saving the copy, choose **No** and press the **OK** button.

The copy is displayed with a black frame.

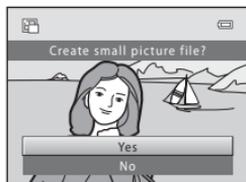

More Information

See "File and Folder Names" ( 199) for more information.

✂ Crop: Creating a Cropped Copy

Create a copy containing only the portion visible in the monitor when **MENU**  is displayed with playback zoom ( 97) enabled. Cropped copies are saved as separate files.

1 Rotate the zoom control to **T** () in full-frame playback mode (89) to zoom in on the image.

To crop an image displayed in “tall” (portrait) orientation, zoom in on the image until the black bars displayed on the both sides of the monitor disappear. The cropped image will be displayed in landscape orientation.

To crop the image in its current “tall” (portrait) orientation, first use the **Rotate image** option ( 124) to rotate the image so that it is displayed in landscape orientation. Next, enlarge the image for cropping, crop the image, and then rotate the cropped image back to “tall” (portrait) orientation.

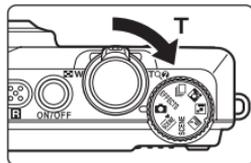

2 Refine copy composition.

Rotate the zoom control to **T** () or **W** () to adjust the zoom ratio.

Press the rotary multi selector , , , or  to scroll the image so that only the portion to be copied is visible in the monitor.



3 Press the **MENU** button.

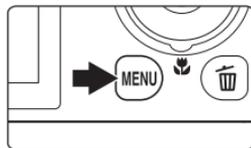

4 Use the rotary multi selector to choose **Yes** and press the **OK** button.

A cropped copy is created.

To exit without saving the copy, choose **No** and press the **OK** button.

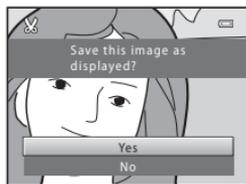

Image Size

As the area to be saved is reduced, the image size (pixels) of the cropped copy is also reduced. When the image size of the cropped copy is 320 × 240 or 160 × 120, a black frame is displayed around the image, and the small picture icon  or  is displayed in the left of the monitor in playback mode.

More Information

See “File and Folder Names” ( 199) for more information.

Recording Movies

High-definition movies with sound can be recorded.

- Each movie is limited to a file size of 4 GB and a movie length of 29 minutes, even when there is sufficient free space on the memory card for longer recording (📖 149).
- The angle of view (i.e., the area visible in the frame) for movies is narrower compared to that of still images.

If **Monitor settings** (📖 175) in the setup menu is set to **Movie frame+auto info**, the area that will be visible in the movie can be confirmed before movie recording starts.

1 Turn on the camera and be sure that it is in shooting mode.

Movies can be recorded in any shooting mode (📖 45).

The icon for the selected movie option is displayed. The default setting is **1080p HD 1080p★ (1920×1080)** (📖 148).



Movie option

2 Press the **MOVIE-RECORD** button to start movie recording.

Movie recording begins after the monitor briefly turns off.

The camera focuses at the center of the frame. Focus areas are not displayed during recording.

When recording movies in HD or Full HD, monitor display changes to an aspect ratio of 16:9 with movie recording (the area indicated at right is recorded).

The approximate remaining movie length is displayed during recording.

Recording stops automatically when the maximum movie length has been recorded.

If the shutter-release button is pressed all the way while recording, one frame is saved as a still image (📖 142).



3 Press the **MOVIE-RECORD** button again to end recording.

✔ Note on Saving Movies

After a movie has been recorded, it is not fully saved to the internal memory or memory card until monitor display returns to the shooting display. **Do not open the battery-chamber/memory card slot cover** before movies have been fully saved. Removing the memory card or the battery while a movie is being saved may result in loss of the movie data or damage to the camera or to the memory card.

✓ Notes on Recording Movies

- Memory cards with an SD Speed Class rating of 6 or faster are recommended when recording movies (📖 198). Movie recording may stop unexpectedly when memory cards with a lower Speed Class ratings are used.
- There may be some degradation in image quality when digital zoom is used. If the digital zoom is not being used when movie recording begins, rotating and holding the zoom control at **T** zooms the image using optical zoom and the zoom stops at the maximum optical zoom ratio. After letting go of the zoom control, rotate the zoom control to **T** again to magnify the image using the digital zoom.
- When recording ends, digital zoom turns off.
- The sounds of zoom control operation, zoom, autofocus lens drive movement, and aperture operation when brightness changes may be recorded.
- The following phenomena may be seen in the monitor while recording movies. These phenomena are saved in the recorded movies.
 - Banding may occur in images under fluorescent, mercury-vapor, or sodium-vapor lighting
 - Subjects that move quickly from one side of the frame to the other, such as a moving train or car, may appear skewed
 - The entire movie image may be skewed when the camera is panned.
 - Lighting or other bright areas may leave residual images when the camera is moved

✓ Notes on Autofocus

- When **AF Single AF** (default setting) is selected for **Autofocus mode** in movie menu, focus is locked by pressing the **● (📷 movie-record)** button to start recording (📖 150).
- Autofocus may not perform as expected (📖 29). Should this occur, try the following:
 1. Set **Autofocus mode** in the movie menu to **AF Single AF** (default setting) before starting movie recording.
 2. Frame another subject—positioned at the same distance from the camera as the intended subject—in the center of the frame, press the **● (📷 movie-record)** button to start recording, and then modify the composition.

✓ Camera Temperature

The camera may become warm when shooting movies for an extended period of time or when the camera is used in a hot area; this is not a malfunction.

📎 Functions Available with Movie Recording

- The creative slider, white balance (when using **📷 (auto)** mode, continuous shooting mode), or exposure compensation settings are also applied when recording movies. The tone that results from using special effects mode (📖 85) or scene mode (📖 64) is also applied to movies. When macro mode is enabled, movies of subjects closer to the camera can be recorded. Confirm settings before starting movie recording.
- The self-timer (📖 35) can be used. If the self-timer is set and the **● (📷 movie-record)** button is pressed, the camera focuses and starts movie recording after ten or two seconds.
- The flash will not fire.
- Press the **MENU** button to select the **📷 (movie)** tab and adjust movie menu settings before starting movie recording (📖 146).

Capturing Still Images While Recording Movies

If the shutter-release button is pressed all the way while recording a movie, one frame is saved as a still image (except when **Movie options** (📖 148) is set to **iFrame** **iFrame 540 (960×540)**). Movie recording continues while the still image is being saved.



- A still image can be saved when  is displayed at the top left of the monitor.
-  is not displayed while saving still images. Another still image cannot be saved until  is displayed again.
- The image size of the saved still image depends on the **Movie options** (📖 148) settings. The compression ratio is approximately 1:8.

Movie options	Size of still image
 HD 1080p★ (1920×1080)/  HD 1080p (1920×1080)	 (1920 × 1080)
 HD 720p (1280×720)	 (1280 × 720)
 VGA (640×480)	 (640 × 480)

✔ Notes on Saving Still Images During Movie Recording

- When the remaining movie length is less than 30 seconds, still images cannot be saved.
- When recording an HS movie (📖 143), still images cannot be saved.
- The sound of the shutter-release button being pressed may be heard in the recorded movie.
- If the camera moves when the shutter-release button is pressed, the image may be blurred.

📎 File Names of Saved Still Images

The file numbers assigned to captured still images ascend in order, starting with the file number of the movie being recorded +1.

💡 More Information

See "File and Folder Names" (📖 199) for more information.

Recording Movies in Slow Motion and Fast Motion (HS Movie)

HS (high speed) movies can be recorded. The portions of the movie recorded using HS movie can be played back in slow motion at 1/8 or 1/2 of normal playback speed, or played back in fast motion at a speed two times faster than normal speed. While recording movies, the camera can be switched from normal speed movie recording to slow motion or fast motion movie recording.

- HS movies →  145

- 1 Display the movie menu ( 146), use the rotary multi selector to choose **Movie options**, and then press the  button.

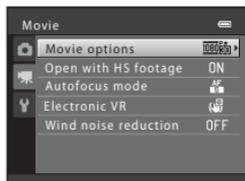

- 2 Confirm or change HS movie settings, and then press the  button.

Movie Options →  148

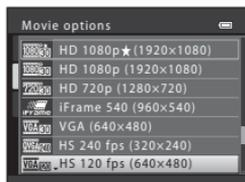

- 3 Select **Open with HS footage** and press  to choose whether the camera records normal speed movies or HS movies (slow motion or fast motion movies) when movie recording starts.

On (default setting): HS movies are recorded when recording begins.

Off: Normal speed movies are recorded when recording begins. Press the  button to switch to HS movie recording at the point where the camera should record for slow motion or fast motion playback.

Press the **MENU** button after changing the settings and return to the shooting screen.

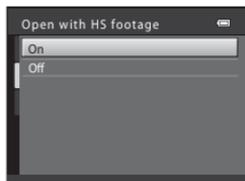

4 Press the **REC** (movie-record) button to start recording.

Movie recording begins after the monitor briefly turns off. The camera focuses at the center of the frame. Focus areas are not displayed during recording.

When the **Open with HS footage** checkbox in the movie menu is turned on, HS movies are recorded when recording begins.

When the **Open with HS footage** checkbox in the movie menu is turned off, normal speed movies are recorded when recording begins. Press the **OK** button to switch to HS movie recording at the point where the camera should record for slow motion or fast motion playback.

If the maximum movie length for HS movies (148) is exceeded, or if the **OK** button is pressed, the camera switches to normal speed movie recording. The camera switches between normal speed movie recording and HS movie recording each time the **OK** button is pressed.

When recording HS movies, the maximum movie length display changes and displays the remaining movie length for HS movie recording.

The HS movie options that are displayed change depending on the type of movie being recorded.

HS movie options

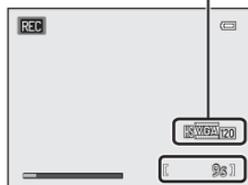

When recording HS movies



When recording normal speed movies

5 Press the **REC** (movie-record) button to end recording.

✓ Notes on HS Movie

- Portions recorded for slow motion or fast motion playback are not recorded with sound.
- When recording HS movies, vibration reduction cannot be used. Zoom position, focus, exposure, and white balance are locked when the  button is pressed to start recording.

HS Movie

Recorded movies are played back at about 30 frames per second, including portions recorded using HS movie.

When **Movie options** ( 148) is set to **HS 240 fps (320×240)**, **HS 120 fps (640×480)**, or **HS 60 fps (1280×720)**, movies that can be played back in slow motion can be recorded. When set to **HS 15 fps (1920×1080)**, movies that can be played back in fast motion at a speed two times faster than normal speed can be recorded.

Portions recorded at HS 240 fps (320 × 240):

High-speed capturing is possible for up to ten seconds. Portions captured at high speed are played back in slow motion at a speed eight times slower than normal speed.

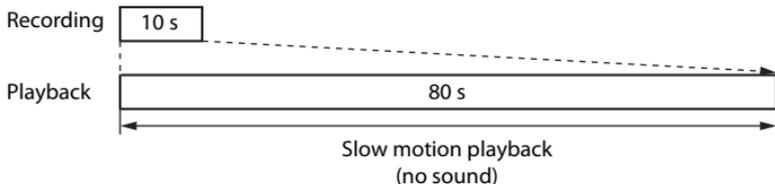

Portions recorded at HS 15 fps (1920 × 1080):

A movie of up to two minutes in length is recorded when shooting for the purpose of high-speed playback. Playback is two times faster.

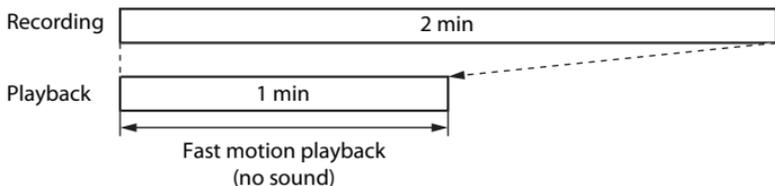

Returning from HS Movie Setting to Normal Speed Movie Setting

In **Movie options** in the movie menu, select the normal speed movie type and press the  button ( 140, 148).

Changing Movie Recording Settings

The following options can be adjusted from the movie menu.

Movie options

📖 148

Select the desired movie option to record. The camera can record normal speed movies and high speed (HS) movies, which can be played back in slow motion or fast motion.

Open with HS footage

📖 143, 150

When the camera is configured in the **Movie options** screen to record HS movies (slow motion or fast motion movies), select whether the camera records normal speed movies or HS movies when movie recording starts.

Autofocus mode

📖 150

Select how the camera focuses during movie recording.

Electronic VR

When the camera is configured in the **Movie options** screen to record normal speed movies, select whether the camera uses electronic vibration reduction.

Wind noise reduction

📖 151

Set whether or not to reduce wind noise during movie recording.

Displaying the Movie Menu

- 1 Press the **MENU** button in shooting mode.

The menu is displayed.

If the **MENU** button was pressed in  (scene auto selector), press the rotary multi selector ( 11)  to display the tabs.

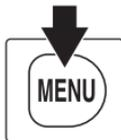

- 2 Press the rotary multi selector .

Tab selection is activated.

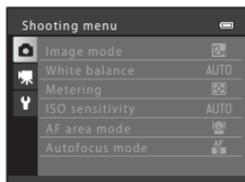

- 3** Press ▲ or ▼ to choose the  tab.



- 4** Press ► or the  button.

The movie menu items can be selected.

Use the rotary multi selector to choose and apply settings ( 11).

To exit the movie menu, press the **MENU** button or ◀ to select a different tab.

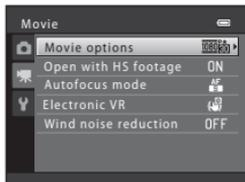

Movie Options

Switch to shooting mode → MENU →  (Movie)  146 → Movie options

Select the options for recording movies.

Larger image sizes and faster movie bitrates mean greater image quality and larger movie file sizes.

- When recording normal speed movies,  **HD 1080p★ (1920×1080)**,  **HD 1080p (1920×1080)**,  **HD 720p (1280×720)**,  **iFrame 540 (960×540)**, and  **VGA (640×480)** are available.
- When recording HS movies,  **HS 240 fps (320×240)**,  **HS 120 fps (640×480)**,  **HS 60 fps (1280×720)**, and  **HS 15 fps (1920×1080)** are available.

Type	Description
 HD 1080p★ (1920×1080) (default setting)	Movies with an aspect ratio of 16:9 are recorded in Full HD. This option is suited to playback on a TV that supports Full HD. <ul style="list-style-type: none"> • Image size: 1920 × 1080 pixels • Movie bitrate: 14 Mbps
 HD 1080p (1920×1080)	Movies with an aspect ratio of 16:9 are recorded in Full HD. This option is suited to playback on a TV that supports Full HD. <ul style="list-style-type: none"> • Image size: 1920 × 1080 pixels • Movie bitrate: 12 Mbps
 HD 720p (1280×720)	Movies with an aspect ratio of 16:9 are recorded in high definition. This option is suited to playback on a wide screen TV. <ul style="list-style-type: none"> • Image size: 1280 × 720 pixels • Movie bitrate: 9 Mbps
 iFrame 540 (960×540)	Movies with an aspect ratio of 16:9 are recorded. A format supported by Apple Inc. <ul style="list-style-type: none"> • Image size: 960 × 540 pixels • Movie bitrate: 24 Mbps • Still images cannot be saved during movie recording ( 142), and movies cannot be edited ( 153). • When recording movies to the internal memory, recording may stop unexpectedly in some shooting conditions. When recording movies of important events, recording to a memory card (class 6 or higher) is recommended.
 VGA (640×480)	Movies with an aspect ratio of 4:3 are recorded. <ul style="list-style-type: none"> • Image size: 640 × 480 pixels • Movie bitrate: 640 kbps
 HS 240 fps (320×240)	1/8-speed slow motion movies with a 4:3 aspect ratio are recorded. <ul style="list-style-type: none"> • Max. recording time*: 10 seconds (playback time: 80 seconds) • Image size: 320 × 240 pixels • Movie bitrate: 640 kbps

Type	Description
 HS 120 fps (640×480)	1/4-speed slow motion movies with a 4:3 aspect ratio are recorded. <ul style="list-style-type: none"> • Max. recording time*: 10 seconds (playback time: 40 seconds) • Image size: 640 × 480 pixels • Movie bitrate: 3 Mbps
 HS 60 fps (1280×720)	1/2-speed slow motion movies with a 16:9 aspect ratio are recorded. <ul style="list-style-type: none"> • Max. recording time*: 30 seconds (playback time: 1 minute) • Image size: 1280 × 720 pixels • Movie bitrate: 9 Mbps
 HS 15 fps (1920×1080)	2× speed fast motion movies with a 16:9 aspect ratio are recorded. <ul style="list-style-type: none"> • Max. recording time*: 2 minutes (playback time: 1 minute) • Image size: 1920 × 1080 pixels • Movie bitrate: 12 Mbps

* The maximum recording time shown here refers only to the portion of the movie that is recorded in slow motion or fast motion.

- The movie bitrate is the volume of movie data recorded per second. Variable bitrate (VBR) encoding is used to automatically adjust the bitrate depending on the subject being recorded. When recording movies of subject with large amounts of motion, the file size increases.
- The frame rate is approximately 30 frames per second in any options.

Maximum Movie Length

Type	Internal memory (approx. 74 MB)	Memory card (4 GB)*
 HD 1080p★ (1920×1080) (default setting)	42 s	35 min
 HD 1080p (1920×1080)	49 s	40 min
 HD 720p (1280×720)	1 min 5 s	55 min
 iFrame 540 (960×540)	21 s	15 min
 VGA (640×480)	3 min 9 s	2 h 30min

All figures are approximate. The maximum movie length may vary by make of memory card.

* Each movie is limited to a file size of 4 GB and a movie length of 29 minutes, even when there is sufficient free space on the memory card for longer recording. The maximum movie length that can be recorded for a single movie is displayed during recording.

More Information

See “File and Folder Names” (📖 199) for more information.

Open with HS Footage

Switch to shooting mode → MENU →  (Movie)  146 → Open with HS footage

Select whether the camera records normal speed movies or HS movies (slow motion or fast motion movies) when movie recording starts.

Option	Description
On (default setting)	Record HS movies when movie recording begins.
Off	Record normal speed movies when movie recording begins. Press the  button to switch to HS movie recording at the point where the camera should record for slow motion or fast motion playback.

Autofocus Mode

Switch to shooting mode → MENU →  (Movie)  146 → Autofocus mode

Select the autofocus method used when recording normal speed movies.

Option	Description
 Single AF (default setting)	Focus is locked when the  (movie-record) button is pressed to start recording. Select this option when the distance between the camera and the subject will remain fairly consistent.
 Full-time AF	Camera focuses continuously. Select this option when the distance between the camera and subject will change significantly during recording. The sound of the camera focusing may be heard in the recorded movie. Use of Single AF is recommended to prevent the sound of the camera focusing from interfering with recording.

Autofocus Mode During Movie Recording

When using the **Fireworks show** scene mode, the camera focuses at infinity.

Electronic VR

Switch to shooting mode → MENU →  (Movie) ( 146) → Electronic VR

When the camera is configured in the **Movie options** screen to record normal speed movies, select whether the camera uses electronic vibration reduction.

Option	Description
 On (default setting)	Reduces the effects of camera shake when recording movies.
OFF Off	Electronic vibration reduction is disabled.

When **Electronic VR** is set to **On**,  is displayed when movie recording starts ( 6).

Note on Electronic Vibration Reduction

When recording HS movies, vibration reduction cannot be used.

Wind Noise Reduction

Switch to shooting mode → MENU →  (Movie) ( 146) → Wind noise reduction

Select whether wind noise is reduced when recording normal speed movies.

Option	Description
 On	Reduces the sound heard when wind passes over the microphone. Use when recording movies in locations with strong winds. Other sounds may become difficult to hear during playback.
OFF Off (default setting)	Wind noise reduction is not enabled.

The wind noise reduction setting can be confirmed in the monitor when shooting ( 6). When **Off** is selected, an icon for the current setting is not displayed.

Movie Playback

In full-frame playback mode (📖 89), movies can be identified by the **Movie options** icon (📖 148). To play a movie, display it in full-frame playback mode and press the **OK** button.

Rotate the zoom control to **T** or **W** to adjust playback volume.

Rotate the rotary multi selector to advance or rewind the movie.

Playback controls are displayed at the top of the monitor. Press the rotary multi selector ◀ or ▶ to choose a control. The operations described below are available.

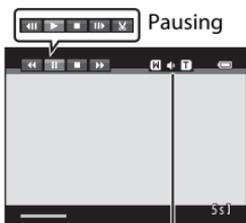

During playback

Volume indicator

Function	Icon	Description
Rewind	◀	Hold down the OK button to rewind the movie.
Advance	▶	Hold down the OK button to advance the movie.
Pause	⏸	Press the OK button to pause playback. The following operations can be performed while playback is paused using the controls displayed at the top in the monitor.
		 Press the OK button to rewind the movie. Hold down the OK button for continuous rewinding.*
		 Press the OK button to advance the movie. Hold down the OK button for continuous advancing.*
		 Press the OK button to resume playback.
		Press the OK button to cut unwanted portions of a movie so that only the desired portions of a movie are saved (📖 153).
End	■	Press the OK button to return to full-frame playback mode.

* The movie can also be advanced or rewound by rotating the rotary multi selector.

✓ Playing Back Movies

The COOLPIX S9100 is not able to playback movies recorded with another make or model of digital camera.

Deleting Movies

Select a movie and press the  button in full-frame playback mode (📖 89) or thumbnail playback mode (📖 94). A confirmation dialog is displayed. See “Deleting Unwanted Images” (📖 31) for more information.

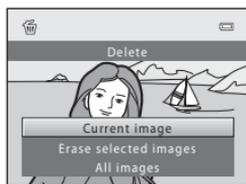

Editing Movies

The desired portions of a recorded movie can be saved as a separate file (except movies recorded using  **iFrame 540 (960x540)** (📖 148)).

1 Play back the desired movie and pause playback (📖 152).

2 Press the rotary multi selector ◀ or ▶ to choose the  control, and then press the  button.

The movie edit screen is displayed.

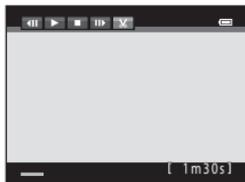

3 Press ▲ or ▼ to choose the  control (choose start point).

When editing begins, the frame where playback was paused is the start point.

Rotate the rotary multi selector or press ◀ or ▶ to move the start point to the beginning of the desired portion of the movie.

To cancel editing, press ▲ or ▼ to choose  (return), and press the  button.

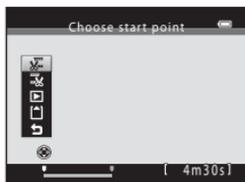

4 Press ▲ or ▼ to choose  (choose end point).

Rotate the rotary multi selector or press ◀ or ▶ to move the end point on the right edge to the end of the desired portion of the movie.

Select  (preview) and press the  button to play back the specified portion of the movie that will be saved.

While the preview is playing, rotate the zoom control to **T/W** to adjust the volume.

Rotate the rotary multi selector to advance or rewind the movie. While the preview is playing back, press the  button again to stop playback.

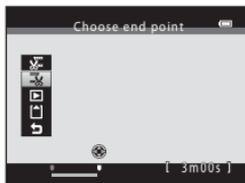

5 When the settings are finished, press ▲ or ▼ to choose  **Save** and press the  button.

6 Choose **Yes** and press the **OK** button.

The edited movie is saved.

To exit without saving, select **No**.

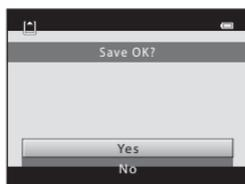

✓ **Notes on Movie Editing**

- A movie that was created by editing cannot be trimmed again. To trim another area of the movie, select and edit the original movie.
- Movies are trimmed in one-second intervals, therefore the actual trimmed portion of the movie may differ slightly from the selected start and end points. Movies cannot be trimmed so that they are less than 2 seconds long.
- Editing functions are not available when there is not enough free space in the internal memory or on the memory card to save the edited copies.

📖 **More Information**

See "File and Folder Names" (📖 199) for more information.

Connecting to a TV

Connect the camera to a television to play images or movies back on the television. If your TV is equipped with an HDMI jack, a commercially available HDMI cable can be used to connect the camera to the TV for high-definition display.

- 1 Turn off the camera.

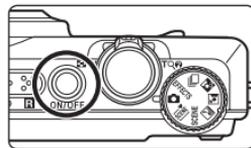

- 2 Connect the camera to the TV.

When using the supplied audio/video cable

Connect the yellow plug to the video-in jack and the white and red plugs to the audio-in jacks on the TV.

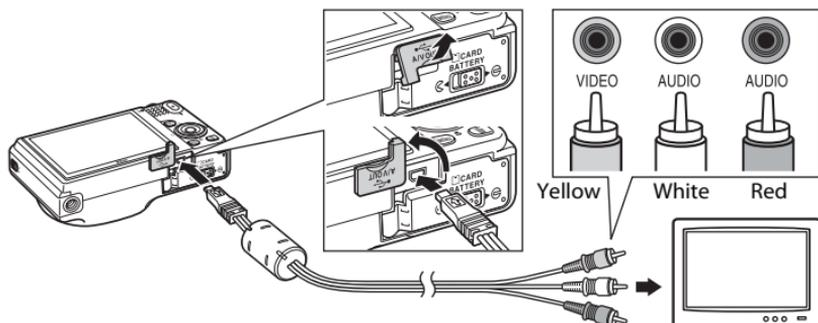

When using a commercially available HDMI cable

Connect the plug to the HDMI jack on the TV.

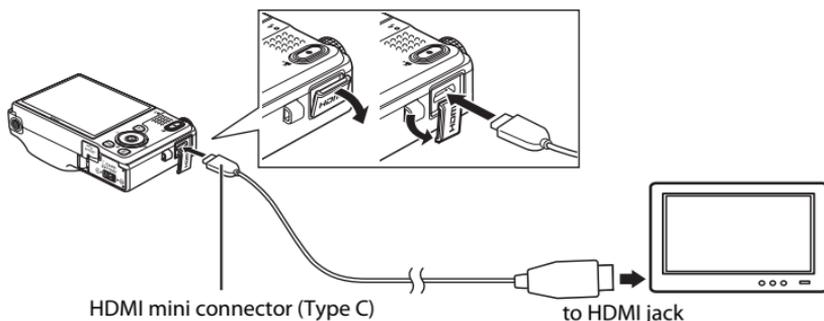

3 Tune the television to the video channel.

See the documentation provided with your television for details.

4 Hold down the button to turn on the camera.

The camera enters playback mode and images are displayed on the television.

While connected to the TV, the camera monitor will remain off.

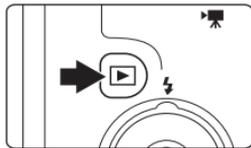

Notes on Connecting the HDMI Cable

- HDMI cable is not provided. Use a commercially available HDMI cable to connect the camera to a high-definition TV. The output terminal on this camera is an HDMI mini connector (type C). When purchasing an HDMI cable, be sure that the device end of the cable is an HDMI mini connector.
- **Image mode** ( 47) settings of  **2048x1536** or higher and **Movie options** ( 148) settings of **HD 720p (1280x720)** or higher are recommended for images or movies that will be played back on a TV via HDMI connection.

Notes on Connecting the Cable

- When connecting the cable, be sure that the camera connector is properly oriented. Do not use force when connecting the cable to the camera. When disconnecting the cable, do not pull the connector at an angle.
- Do not connect cables to the HDMI mini connector (Type C) and to the USB/audio/video output connector simultaneously.

If the Images Are Not Displayed on the Television

Be sure that the camera's video mode setting in the **Set up** menu ( 169) → **TV settings** ( 186) conforms to the standard used by your television.

Using a TV Remote Control (HDMI Device Control)

The remote control of an HDMI-CEC-compatible TV can be used to control playback.

It can be used instead of the camera's rotary multi selector and zoom control to select images, start and pause movie playback, scroll playback of images captured using easy panorama, and switch between full-screen playback mode and 4-image thumbnail display.

- Set the **HDMI device control** setting ( 186) of **TV settings** to **On** (default setting) and then connect the camera and TV using an HDMI cable.
- Aim the remote control at the TV when operating it.
- Refer to the TV's operating instructions for information about the TV's HDMI-CEC compatibility.

Connecting to a Computer

Use the supplied USB cable to connect the camera to a computer and copy (transfer) images to the computer.

Before Connecting the Camera

Install the Software

Use the supplied ViewNX 2 CD and install the following software on the computer. For more information on installing the software, refer to the *Quick Start Guide*.

- ViewNX 2: Use the image transfer feature “Nikon Transfer 2” to save images that were captured with the camera on the computer. Saved images can be viewed and printed. Image and movie editing features are also supported.
- Panorama Maker 5: This software can join a series of images to create a single panorama image.

Compatible Operating Systems

Windows

Windows 7 Home Basic/Home Premium/Professional/Enterprise/Ultimate, Windows Vista Home Basic/Home Premium/Business/Enterprise/Ultimate (Service Pack 2), or Windows XP Home Edition/Professional (Service Pack 3)

Macintosh

Mac OS X (version 10.4.11, 10.5.8, 10.6.5)

For information on the requirements for playing back high-definition movies, refer to “System Requirements” in the ViewNX 2 help information (📖 161).

Refer to the Nikon website for the latest information on operating system compatibility.

Note on Computer Connection

Disconnect other USB devices such as commercial USB chargers from the computer. Simultaneous connection of the camera and other USB devices to the computer could result in operation malfunction or excessive supply of power to the camera, causing damage to the camera or memory card. Refer to the documentation supplied with other USB devices for more information.

Connecting to a Computer

✔ Notes on Power Source

- When connecting the camera to a computer, use a battery with a sufficient amount of charge remaining to prevent the camera from turning off unexpectedly.
- When the camera is connected to a computer via the supplied USB cable with **Auto** (default setting) selected for the **Charge by computer** option in the setup menu, the battery inserted into the camera is automatically charged using power supplied by the computer (162, 187).
- If the AC Adapter EH-62F (197) (available separately) is used, COOLPIX S9100 can be powered from an electrical outlet. Do not use any other make or model of AC adapter as they may cause the camera to overheat or malfunction.

Transferring Images from a Camera to a Computer

- 1 Start the computer to which ViewNX 2 was installed.
- 2 Be sure that the camera is off.
- 3 Connect the camera to the computer using the supplied USB cable.

Be sure that connectors are properly oriented. Do not attempt to insert connectors at an angle, and do not use force when connecting or disconnecting the USB cable.

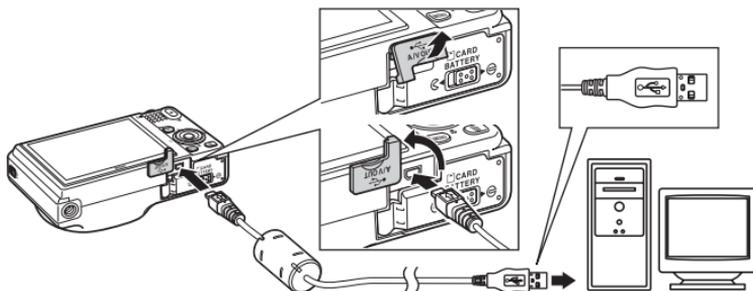

The camera is automatically turned on and the power-on lamp will light. The camera monitor will remain off.

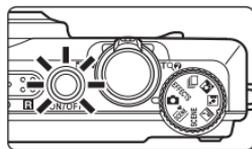

✔ Connecting the USB Cable

The connection may not be recognized if the camera is connected to the computer via a USB hub.

4 Start the ViewNX 2 image transfer feature “Nikon Transfer 2” installed on the computer.

• Windows 7

When the **Devices and Printers ▶ S9100** screen is displayed, click **Change program** under **Import pictures and videos**. Select **Import File using Nikon Transfer 2** in the **Change program** dialog and click **OK**.

Double-click **Import File** on the **Devices and Printers ▶ S9100** screen.

• Windows Vista

When the **AutoPlay** dialog is displayed, click **Import File using Nikon Transfer 2**.

• Windows XP

When the action selection dialog is displayed, select **Nikon Transfer 2 Import File**, and click **OK**.

• Mac OS X

Nikon Transfer 2 will start automatically when the camera is connected to the computer if **Yes** was selected in the **Auto-Launch setting** dialog when ViewNX 2 was first installed.

• See “Starting Nikon Transfer 2 Manually” (📖 161) for more information.

• If charge for the battery inserted into the camera is low, the computer may not recognize the camera. If the camera is not recognized, images will not be transferred. When battery charging starts automatically using power supplied by the computer, wait until battery charge has reached a sufficient level to begin transfer.

• If there are a large number of images on the memory card, it may take some time for Nikon Transfer 2 to start.

5 Confirm that the source device is displayed in the transfer options **Source** panel and click **Start Transfer**.

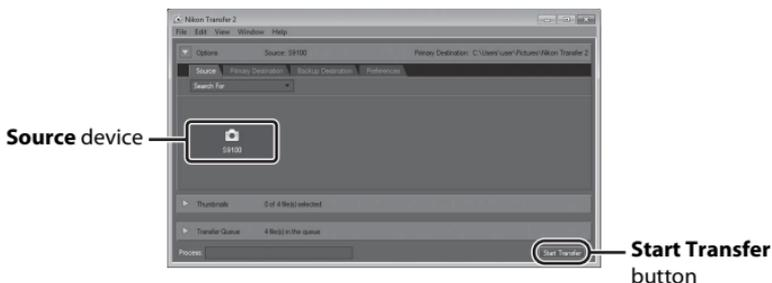

Any images that have not been transferred to the computer will be transferred (default setting of ViewNX 2).

Connecting to a Computer

When transfer is complete, the ViewNX 2 screen is displayed (ViewNX 2 default setting) and transferred images are displayed.

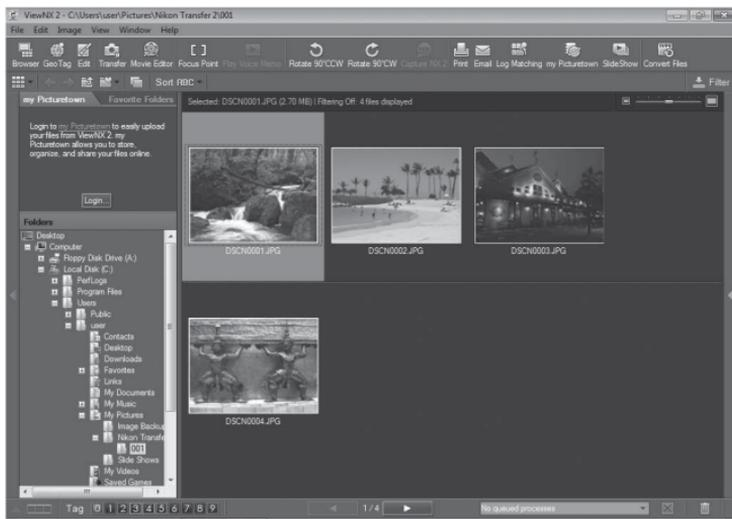

For more information on using ViewNX 2, refer to the ViewNX 2 help information (161).

Disconnecting the Camera

Do not turn off the camera or disconnect the camera from the computer during transfer.

When transfer is complete, turn off the camera and disconnect the USB cable.

The camera turns off automatically if there is no communication with the computer for 30 minutes while the camera is connected via the USB cable.

Charging the Battery

The charge lamp slowly blinks green while the battery inserted into the camera is charging (162).

Transferring Images Using a Computer's Card Slot or a Commercially-available Card Reader

When the memory card is inserted into a computer's card slot or into a commercially-available card reader, the images can be transferred using "Nikon Transfer 2", the image transfer feature of ViewNX 2.

- Make sure that the memory card being used is supported by the card reader or other card reading device.
- To transfer images, insert the memory card into the card reader or card slot and follow the procedure from step 4 (📖 159).
- To transfer images saved in the camera's internal memory, the images must first be copied to a memory card using the camera (📖 127).

Starting ViewNX 2 Manually

Windows

Choose **Start** menu > **All Programs** > **ViewNX 2** > **ViewNX 2**.

Double-clicking the **ViewNX 2** shortcut icon on the desktop will also start ViewNX 2.

Mac OS X

Open the **Applications** folder, open the **Nikon Software** > **ViewNX 2** folders in that order, and then double-click the **ViewNX 2** icon. Clicking the **ViewNX 2** icon on the Dock will also start ViewNX 2.

Starting Nikon Transfer 2 Manually

To start Nikon Transfer 2, first start ViewNX 2, and then click the **Transfer** icon at the top of the screen or select **Launch Transfer** from the **File** menu.

For More Information on Using ViewNX 2 and Nikon Transfer 2

For more information on ViewNX 2 or Nikon Transfer 2, start ViewNX 2 or Nikon Transfer 2 and select **ViewNX 2 Help** from the **Help** menu.

Panorama Creation with Panorama Maker 5

- Use a series of images captured in **Panorama assist** scene mode (📖 78) to create a single panorama photo with Panorama Maker 5.
- Panorama Maker 5 can be installed on a computer using the supplied ViewNX 2 CD.
- After installation is complete, follow the procedure described below to start Panorama Maker 5.

Windows

Choose **Start** menu > **All Programs** > **ArcSoft Panorama Maker 5** > **Panorama Maker 5**.

Mac OS X

Open **Applications** and double-click the **Panorama Maker 5** icon.

- For more information on using Panorama Maker 5, refer to the on-screen instructions and help information contained in Panorama Maker 5.

Image File Names and Folder Names

See "File and Folder Names" (📖 199) for more information.

Charging While Connecting to a Computer

When the **Charge by computer** option (📖 187) in the camera's setup menu is set to **Auto** (default setting), if the camera is connected to a computer using the USB cable, the battery inserted into the camera can be automatically charged depending on the ability of the computer to supply power.

See "Before Connecting the Camera" (📖 157) and "Transferring Images from a Camera to a Computer" (📖 158) for more information on connecting the camera to a computer.

Charge Lamp

The following chart explains charge lamp status when the camera is connected to a computer.

Charge lamp	Description
Blinks slowly (green)	Battery charging.
Off	Battery not charging. If the charge lamp changes from slow blinking (green) to off while the power-on lamp is lit, charging is complete.
Flickers (green)	<ul style="list-style-type: none"> The ambient temperature is not suited to charging. Charge the battery indoors with an ambient temperature of 5°C to 35°C (41°F to 95°F). A USB cable is not correctly connected or the battery is faulty. Reconnect the USB cable correctly or replace the battery. Computer is in sleep mode and does not supply power. Reboot the computer. The battery cannot be charged as computer's specifications or settings does not support power supply to the camera.

✓ Notes on Charging with Connection to a Computer

- The battery cannot be charged, nor can data be transferred, when the camera is connected to a computer before the camera's display language and date and time have been set (📖 20). If the camera's clock battery (📖 173) has been exhausted, the date and time must be reset before the battery can be charged or images can be transferred with connection to a computer. In this case, use the Charging AC Adapter EH-69P (📖 16) to charge the battery and then set the camera's date and time.
- If the camera is turned off, charging will also stop.
- If a computer enters sleep mode while charging, charging will stop and the camera may be turned off.
- When disconnecting the camera from a computer, turn the camera off and then disconnect the USB cable.
- It may take longer to charge the battery with connection to a computer than with charging using the Charging AC Adapter EH-69P. Charging time increases when images are transferred while the battery is charging.
- When the camera is connected to a computer, an application installed on the computer, such as Nikon Transfer 2, may start. If the camera was connected to the computer for the sole purpose of charging the battery, exit the application.
- The camera turns off automatically if there is no communication with the computer for 30 minutes after the battery has finished charging.
- Depending upon computer specifications, settings, and power supply and allocation, it may be impossible to charge the battery inserted into the camera via computer connection.

Connecting to a Printer

Users of PictBridge-compatible (📖 215) printers can connect the camera directly to the printer and print images without using a computer.

Follow the procedures below to print images.

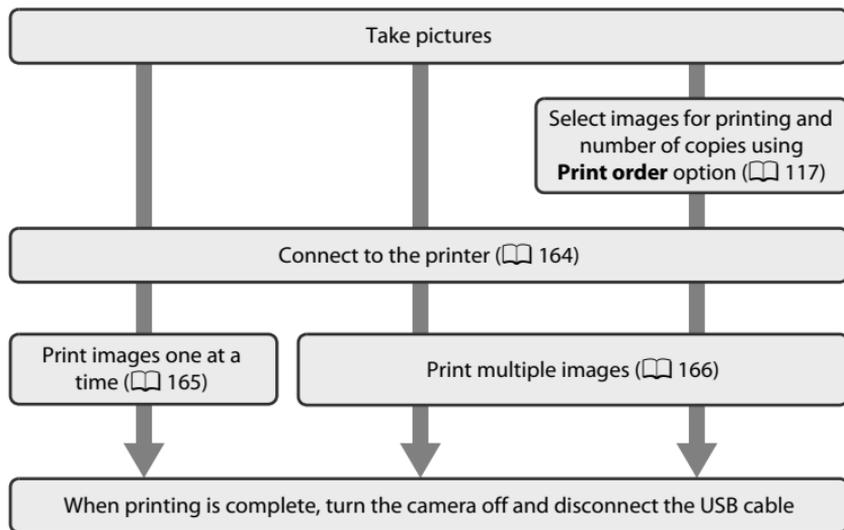

✓ Notes on Power Source

- When connecting the camera to a printer, use a fully charged battery to prevent the camera from turning off unexpectedly.
- If the AC Adapter EH-62F (available separately) is used, COOLPIX S9100 can be powered from an electrical outlet. Do not use any other make or model of AC adapters as they may cause the camera to heat up or malfunction.

🔍 Printing Images

In addition to printing images transferred to a computer from your personal printer and printing over a direct camera-to-printer connection, the following options are also available for printing images saved on the memory card:

- Inserting a memory card into a DPOF-compatible printer's card slot
- Taking a memory card to a digital photo lab

For printing using these methods, specify the images and the number of prints each to the memory card using the **Print order** option in the playback menu (📖 117).

Connecting the Camera to a Printer

- 1 Turn off the camera.

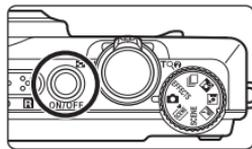

- 2 Turn on the printer.

Check printer settings.

- 3 Connect the camera to the printer using the supplied USB cable.

Be sure that connectors are properly oriented. Do not attempt to insert connectors at an angle, and do not use force when connecting or disconnecting the USB cable.

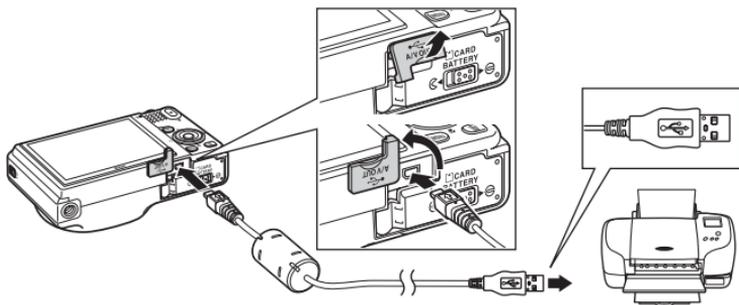

- 4 The camera is automatically turned on.

When properly connected, the **PictBridge** startup screen (①) will be displayed in the camera monitor, followed by the **Print selection** screen (②).

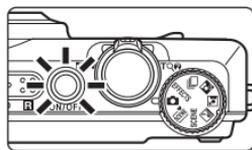

①



②



If the PictBridge Startup Screen Is Not Displayed

Turn the camera off and disconnect the USB cable. Set the **Charge by computer** option (📖 187) in the camera's setup menu to **Off** and reconnect the cable.

Printing Images One at a Time

After properly connecting the camera to the printer (📖 164), follow the procedures described below to print an image.

- 1 Use the rotary multi selector to choose the desired image and press the **OK** button.

Rotate the zoom control to **W** (📷) to display 12 thumbnails, and **T** (📺) to switch back to full-frame playback.



- 2 Choose **Copies** and press the **OK** button.

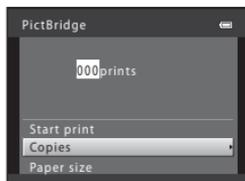

- 3 Choose the desired number of copies (up to nine) and press the **OK** button.

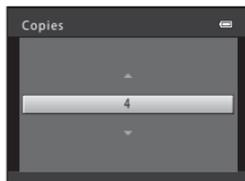

- 4 Choose **Paper size** and press the **OK** button.

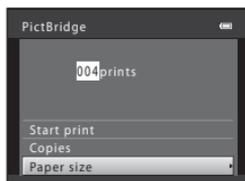

- 5 Choose the desired paper size and press the **OK** button.

To specify paper size using settings on the printer, choose **Default** in the paper size option.

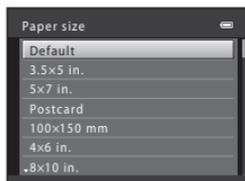

- 6** Choose **Start print** and press the **OK** button.

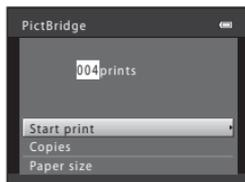

- 7** Printing begins.

Monitor display returns to the screen shown in step 1 when printing is complete.

To cancel printing before all copies have been printed, press the **OK** button.

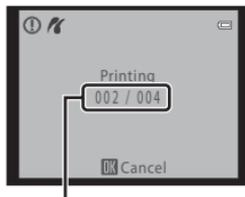

Current number of copies/
total number of copies

Printing Multiple Images

After properly connecting the camera to the printer (📖 164), follow the procedures described below to print multiple images.

- 1** When the **Print selection** screen is displayed, press the **MENU** button.

The **Print menu** screen is displayed.

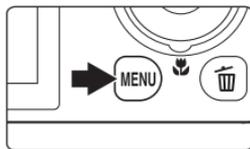

- 2** Use the rotary multi selector to choose **Paper size** and press the **OK** button.

To exit the print menu, press the **MENU** button.

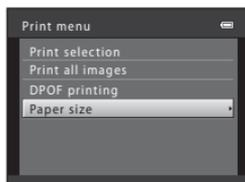

3 Choose the desired paper size and press the **OK** button.

To specify paper size using settings on the printer, choose **Default** in the paper size option.

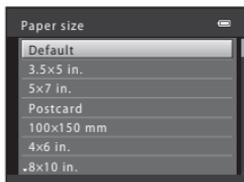

4 Choose **Print selection**, **Print all images**, or **DPOF printing** and press the **OK** button.

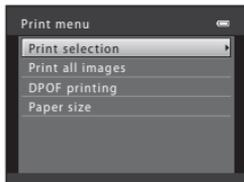

Print selection

Choose images (up to 99) and the number of copies (up to nine) of each.

- Rotate the rotary multi selector, or press ◀ or ▶ to select images, and press ▲ or ▼ to specify the number of copies to be printed.
- Images selected for printing can be identified by the check mark (☑) and the numeral indicating the number of copies to be printed. If no copies have been specified for images, the selection is canceled.
- Rotate the zoom control to **T** (📄) to switch back to full-frame playback or **W** (📄) to display 12 thumbnails.
- Press the **OK** button when setting is complete.
- When the screen shown on the right is displayed, choose **Start print** and press the **OK** button to start printing. Choose **Cancel** and press the **OK** button to return to the print menu.

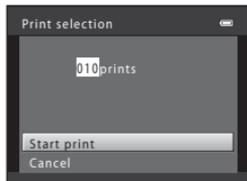

Print all images

One copy each of all images saved in the internal memory, or on the memory card, is printed.

- When the screen shown on the right is displayed, choose **Start print** and press the **OK** button to start print. Choose **Cancel** and press the **OK** button to return to the print menu.

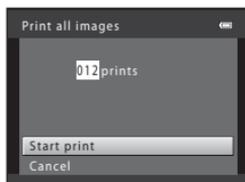

DPOF printing

Print images for which a print order was created using the **Print order** option (117).

- When the screen shown on the right is displayed, choose **Start print** and press the **OK** button to start printing. Choose **Cancel** and press the **OK** button to return to the print menu.
- To view the current print order, choose **View images** and press the **OK** button. To print images, press the **OK** button again.

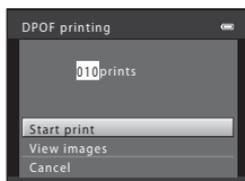

5 Printing begins.

Monitor display returns to the screen shown in step 2 when printing is complete.

To cancel printing before all copies have been printed, press the **OK** button.

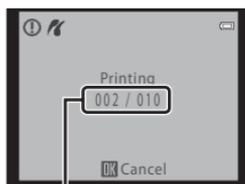

Current number of copies/
total number of copies

Paper Size

The camera supports the following paper sizes: **Default** (the default paper size for the printer connected to the camera), **3.5x5 in.**, **5x7 in.**, **100x150 mm**, **4x6 in.**, **8x10 in.**, **Letter**, **A3**, and **A4**. Only sizes supported by the printer will be displayed.

Setup Menu

The setup menu contains the following options.

Welcome screen	 171
Choose whether or not a welcome screen is displayed when the camera is turned on.	
Time zone and date	 172
Set camera clock and choose home and destination time zones.	
Monitor settings	 175
Adjust photo information display, image review, and monitor brightness settings.	
Print date	 177
Imprint shooting date and time on images.	
Vibration reduction	 178
Choose whether or not vibration reduction is enabled.	
Motion detection	 180
Enable or disable motion detection, which reduces the effects of subject movement and camera shake in still images.	
AF assist	 181
Enable or disable AF-assist illuminator.	
Digital zoom	 182
Enable or disable digital zoom.	
Sound settings	 183
Adjust sound settings.	
Auto off	 184
Set the amount of time that passes before the monitor turns off to save power.	
Format memory/Format card	 185
Format internal memory or memory card.	
Language	 186
Choose the language used for camera monitor display.	
TV settings	 186
Adjust settings necessary for connection to television.	
Charge by computer	 187
Choose whether or not to charge the camera battery when connecting to a computer via the USB cable.	
Blink warning	 188
Specify whether or not the camera detects human faces that have blinked with shooting using face detection.	

Reset all

190

Restore camera settings to default values.

Firmware version

193

Display camera firmware version.

Displaying the Setup Menu

1 Press the MENU button.

The menu is displayed.

If the MENU button was pressed in  (scene auto selector), press the rotary multi selector (📖 11) ◀ to display the tabs.

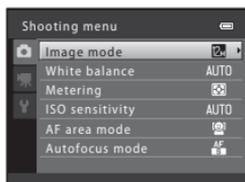
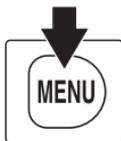

2 Press the rotary multi selector ◀.

Tab selection is activated.

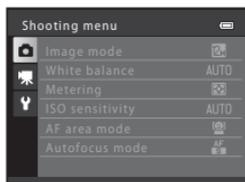

3 Press ▲ or ▼ to choose the Y tab.

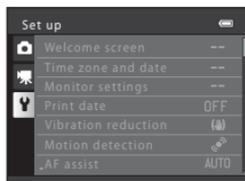

4 Press ► or the OK button.

The setup menu items can be selected.

Use the rotary multi selector to choose and apply settings (📖 11).

To exit the setup menu, press the MENU button or ◀ to select a different tab.



Welcome Screen

MENU button →  (Setup menu) (📖 170) → Welcome screen

Choose whether or not a welcome screen is displayed when the camera is turned on.

None (default setting)

The camera enters shooting or playback mode without displaying the welcome screen.

COOLPIX

The camera displays a welcome screen and enters shooting or playback mode.

Select an image

Displays an image selected for the welcome screen. When the image selection screen is displayed, select an image (📖 123) and press the  button.

- As the selected image is saved by the camera, it will be displayed when the camera is turned on even if the original image is deleted.
- Images captured at an **Image mode** (📖 47) setting of  **3968x2232**, images captured using easy panorama, copies created at a size of 320 x 240 or smaller using the small picture (📖 138) or crop (📖 139) function, and still images saved while recording high-definition or Full HD movies (📖 142) cannot be selected.

Time Zone and Date

MENU button →  (Setup menu) (📖 170) → Time zone and date

Set the camera clock.

Date and time

Set camera clock to current date and time.

Use the rotary multi selector to set the date and time in the date screen.

- Select an item: Press  or  (changes between **D**, **M**, **Y**, **hour**, **minute**).
- Edit the highlighted item: Rotate the rotary multi selector or press  or .
- Apply the setting: Select the minute setting and press the  button.

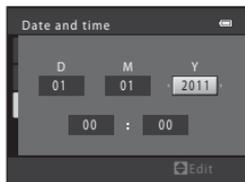

Date format

The available date formats are **Year/Month/Day**, **Month/Day/Year**, and **Day/Month/Year**.

Time zone

 **Home time zone** can be specified and daylight saving time is enabled or disabled. When the travel destination () is selected, local time (📖 174) is automatically calculated and images are saved with the shooting date and time of the selected region. This can be useful when travelling.

Selecting Travel Destination Time Zone

- 1 Use the rotary multi selector to choose **Time zone** and press the  button.

The **Time zone** screen is displayed.

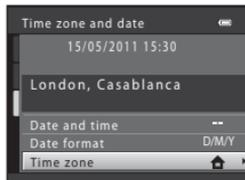

- 2 Choose  **Travel destination** and press the  button.

The date and time displayed in the monitor changes according to the region currently selected.

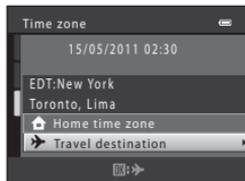

3 Press ►.

The travel destination screen is displayed.

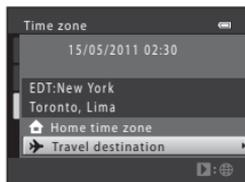
**4** Press ◀ or ▶ to choose the travel destination time zone.

If daylight saving time is in effect, press ▲ to enable daylight saving time function. ☀ is displayed at the top of the monitor and the camera clock is advanced one hour. Press ▼ to disable the daylight saving time function.

Press the **OK** button to apply the travel destination time zone.

While the travel destination time zone is selected, the 📍 icon will be displayed in the monitor when the camera is in shooting mode.

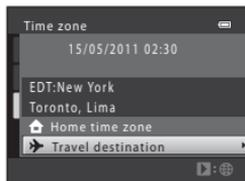
**✔** **Clock Battery**

The camera clock is powered by the clock battery. The clock battery charges when the main battery is inserted or an AC adapter is connected, and can provide several days of backup power after about ten hours of charging.

📌 **Home Time Zone**

- To switch to the home time zone, choose **Home time zone** in step 2 and press the **OK** button.
- To change the home time zone, choose **Home time zone** in step 2, and complete steps 3 and 4.

📌 **Daylight Saving Time**

When daylight saving time starts or ends, turn the daylight saving time function on or off from the time zone selection screen displayed in step 4.

📌 **Imprinting Date on Images**

Enable print date from the **Print date** option (📄 177) in the setup menu after the date and time have been set. When the **Print date** option is enabled, images will be saved with shooting date imprinted on them.

 **Time Zones**

The camera supports the time zones listed below.

For time zones not listed below, set the camera clock to local time from the **Date and time** option.

UTC +/-	Location	UTC +/-	Location
-11	Midway, Samoa	+1	Madrid, Paris, Berlin
-10	Hawaii, Tahiti	+2	Athens, Helsinki, Ankara
-9	Alaska, Anchorage	+3	Moscow, Nairobi, Riyadh, Kuwait, Manama
-8	PST (PDT): Los Angeles, Seattle, Vancouver	+4	Abu Dhabi, Dubai
-7	MST (MDT): Denver, Phoenix	+5	Islamabad, Karachi
-6	CST (CDT): Chicago, Houston, Mexico City	+5.5	New Delhi
-5	EST (EDT): New York, Toronto, Lima	+6	Colombo, Dhaka
-4.5	Caracas	+7	Bangkok, Jakarta
-4	Manaus	+8	Beijing, Hong Kong, Singapore
-3	Buenos Aires, Sao Paulo	+9	Tokyo, Seoul
-2	Fernando de Noronha	+10	Sydney, Guam
-1	Azores	+11	New Caledonia
±0	London, Casablanca	+12	Auckland, Fiji

Monitor Settings

MENU button →  (Setup menu) ( 170) → Monitor settings

Set the options below.

Photo info

Choose information displayed in the monitor during shooting and playback mode. → ( 176)

Image review

On (default setting): The captured image is displayed immediately after shooting, and then the camera returns to the shooting screen.

Off: The captured image is not displayed after shooting.

Brightness

Choose from five settings for monitor brightness. The default setting is **3**.

Photo Info

Select whether or not the photo information is displayed in the monitor.

See “The Monitor” (📖 6) for information on indicators displayed in the monitor.

	Shooting mode	Playback mode
Show info		
Auto info (default setting)	The same information as in Show info is displayed. If no operations are performed after a few seconds, the display will be the same as Hide info . The information is displayed again when an operation is performed.	
Hide info		
Framing grid+auto info	 <p>In addition to information shown with Auto info above, a framing grid is displayed to help frame pictures. It is not displayed when recording movies.</p>	 <p>The same information as in Auto info is displayed.</p>
Movie frame+auto info	 <p>In addition to information shown with Auto info above, a frame is displayed before recording begins that represents the area that will be captured when recording movies. Depending on the combination of the Image mode setting for still images and the Movie options setting for movies, the size of the movie frame may vary greatly.</p>	The same information as in Auto info is displayed.

Print Date (Imprinting Date and Time)

MENU button →  (Setup menu) ( 170) → Print date

The shooting date and time can be imprinted on the images with shooting, allowing the information to be printed even from printers that do not support date printing ( 120).



 **Date**

Date is imprinted on images.

 **Date and time**

Date and time are imprinted on images.

OFF **Off (default setting)**

Date and time are not imprinted on images.

The icon for the current setting is displayed in the monitor during shooting ( 6). However, when **Off** is selected, no icon is displayed.

Notes on Print Date

- Imprinted dates form a permanent part of image data and cannot be deleted. The date and time cannot be imprinted on images after they have been captured.
- The date cannot be imprinted in the following situations:
 - When using the  (night landscape) (when **Hand-held** is selected),  (night portrait) (when **Hand-held** is selected),  (backlighting) (when **HDR** is set to **On**), **Sports, Museum, Panorama**, or **Pet portrait** (when **Continuous** is selected) scene mode
 - When using continuous shooting mode (except multi-shot 16)
 - When shooting movies
 - When the image is a still image saved during movie recording
- Dates imprinted at an **Image mode** setting ( 47) of **16M 640×480** may be difficult to read. Choose an **Image mode** setting of **19M 1024×768** or higher when using print date.
- The date is saved using the format selected in the setup menu's **Time zone and date** option ( 20, 172).

Print Date and Print Order

When printing from DPOF-compatible printers that support the printing of shooting date and shooting information, the date and information can be printed without imprinting this information on them using settings in the **Print order** option ( 117).

Vibration Reduction

MENU button →  (Setup menu) (📖 170) → Vibration reduction

Choose a vibration reduction option for shooting still images.

Vibration reduction effectively reduces blur, caused by slight hand movement known as camera shake, which commonly occurs when shooting with the camera zoomed in or at slow shutter speeds.

Set **Vibration reduction** to **Off** when shooting still images while using a tripod to stabilize the camera.

On (hybrid)

The effects of camera shake are corrected optically using an image sensor shift method, and electronic vibration reduction is also used in the following situations to process images:

- When the flash does not fire
- When the shutter speed is slower than 1/60 seconds
- When **Self-timer** is disabled
- When ISO sensitivity is 200 or lower

On (default setting)

An image sensor shift method is used to reduce the effects of camera shake when capturing still images.

Camera automatically detects the panning direction and only corrects for vibration due to camera shake. When the camera is panned, for example, vibration reduction reduces only vertical shake. If the camera is tilted, vibration reduction affects only horizontal shake.

OFF Off

Vibration reduction is not enabled.

The current vibration reduction setting can be confirmed in the camera monitor with shooting (📖 6, 25, 140). When **Off** is selected, no icon is displayed.

Vibration Reduction for Movies

Vibration reduction for movie recording can be set with **Electronic VR** (📖 151) in the movie menu (📖 146).

✔ Notes on Vibration Reduction

- Vibration reduction may take a few seconds to activate after the power is turned on, or the camera enters shooting mode from playback mode. Wait until the image of the monitor stabilizes before shooting.
- Due to characteristics of the vibration reduction function, images displayed in the camera's monitor immediately after shooting may be displayed blurry.
- Vibration reduction may be unable to completely eliminate the effects of camera shake in some situations.
- When the **Night landscape** or **Night portrait** scene modes are set to **Tripod**, vibration reduction is turned off.
- When recording HS movies, vibration reduction cannot be used.
- When **On (hybrid)** is selected, electronic vibration reduction may not be able to correct the image if vibrations are very small or very large.
- When **On (hybrid)** is selected, electronic vibration reduction is disabled if shutter speed is fast or very slow.
- When electronic vibration reduction is operating while **On (hybrid)** is selected, the shutter is released twice for each shot and then the image is corrected, therefore more time is needed to save images. The **Shutter sound** (🔊 183) is heard only once. One image is saved.

Motion Detection

MENU button →  (Setup menu) (📖 170) → Motion detection

Enable motion detection to reduce the effects of subject movement and camera shake when shooting still images.



Auto (default setting)

When the camera detects subject movement or camera shake, the ISO sensitivity and shutter speed are automatically increased to reduce blurring.

However, motion detection does not function in the following situations.

- When the flash mode is set to fill-flash
- In  (auto) mode, when **ISO sensitivity** (📖 52) is set to any setting other than **Auto**
- In the following scene modes:
 -  (night landscape) (📖 64)
 -  (night portrait) (📖 65)
 -  (backlighting) (📖 66)
 - **Sports** (📖 68), **Dusk/dawn** (📖 70), **Museum** (📖 72), **Fireworks show** (📖 72), **Panorama** (when **Easy panorama** is selected) (📖 73), **Pet portrait** (📖 74)
- **AF area mode** is in subject tracking (📖 58)
- In continuous shooting mode (📖 80)

OFF Off

Motion detection is not enabled.

The current motion detection setting can be confirmed in the camera monitor with shooting (📖 6, 25). The motion detection icon turns green when the camera detects camera shake and increases shutter speed. When **Off** is selected, no icon is displayed.

Notes on Motion Detection

- Motion detection may be unable to completely eliminate the effects of subject movement and camera shake in some situations.
- Motion detection may not function if the subject exhibits significant movement or is too dark.
- The images captured using motion detection may be somewhat “grainy” in appearance.

AF Assist

MENU button →  (Setup menu) (📖 170) → AF assist

Enable or disable AF-assist illuminator, which assists autofocus operation when the subject is dimly lit.

Auto (default setting)

AF-assist illuminator will be used to assist the focus operation when the subject is dimly lit. The illuminator has a range of about 5.0 m (16 ft.) at the maximum wide-angle position and about 4.0 m (13 ft.) at the maximum telephoto position.

Note that for some scene modes or focus areas even when **Auto** is selected, AF-assist illuminator may not light.

Off

AF-assist illuminator does not light. The camera may be unable to focus under dim lighting.

Digital Zoom

MENU button →  (Setup menu) (📖 170) → Digital zoom

Enable or disable digital zoom.

ON On (default setting)

When the camera is zoomed in to the maximum optical zoom position, rotating the zoom control to **T** () triggers digital zoom (📖 27).

Crop

The zoom magnification is limited to the zoom position where  is displayed (except when recording movies). The zoom magnification is limited to the range in which the digital zoom does not cause deterioration in the quality of still images.

The digital zoom is not available when the image size is  **4000×3000★**,  **4000×3000**, or  **3968×2232**.

When recording movies, the camera performs the same as when **On** is selected.

OFF Off

Digital zoom will not be activated.

Notes on Digital Zoom

- When digital zoom is in effect, the camera focuses at the center of the frame.
- Digital zoom cannot be used in the following situations.
 - When using the scene auto selector,  (night landscape),  (night portrait),  (backlighting) (when **HDR** is set to **On**), **Portrait**, **Panorama** (when **Easy panorama** is selected), and **Pet portrait** scene modes
 - When **AF area mode** is set to subject tracking
 - When continuous shooting mode is set to **Multi-shot 16**
 - When using  (smile timer)
- While digital zoom is in effect, metering is automatically set to center-weighted metering or spot metering (the area in the center of the monitor is metered).
- If the  (movie-record) button is pressed while shooting still images at the crop zoom position, a movie is also recorded with the digital zoom at the zoom position used when shooting still images.

Sound Settings

MENU button →  (Setup menu) ( 170) → Sound settings

Adjust the following sound settings.

Button sound

Select **On** (default setting) or **Off**. When **On** is selected, a beep will sound once when operations are completed successfully, twice when the camera acquires focus on the subject, and three times when an error is detected. Start-up sound will also play when the camera is turned on.

Shutter sound

Select **On** (default setting) or **Off**.
However, when shooting with continuous shooting mode or when a still image is saved while recording a movie, the shutter sound is not heard even when set to **On**.

Note on Sound Settings

Button sounds and the shutter sound are not heard when using the **Pet portrait** scene mode.

Auto Off

MENU button →  (Setup menu) (📖 170) → Auto off

If no operations are performed for a specified amount of time, the monitor turns off and the camera enters standby mode (📖 19).

Choose the time allowed to elapse before the camera enters standby mode from **30 s**, **1 min** (default setting), **5 min**, and **30 min**.

When the Monitor Has Turned Off to Save Power

- When the camera is in standby mode, the power-on lamp blinks.
- If no operations are performed for another three minutes, the camera will turn off automatically.
- When the power-on lamp is blinking, the following operations will turn the monitor back on.
 - Pressing the power switch, shutter-release button,  button, or  button.
 - Rotating the mode dial.

Auto Off

The time allowed to elapse before the camera enters standby mode is fixed in the following situations:

- While menus are displayed: 3 minutes
- During slide show playback: up to 30 minutes
- When the AC Adapter EH-62F is connected: 30 minutes

Format Memory/Format Card

MENU button →  (Setup menu) ( 170) → Format memory/Format card

Use this option to format the internal memory or a memory card.

Formatting the internal memory or memory cards permanently deletes all data. Data that has been deleted cannot be restored. Be sure to transfer important images to a computer before formatting.

Formatting the Internal Memory

To format the internal memory, remove the memory card from the camera.

The **Format memory** option is displayed in the setup menu.

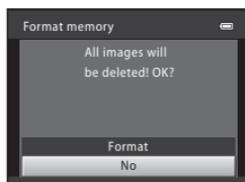

Formatting a Memory Card

When a memory card is inserted in the camera, the **Format card** option is displayed in the setup menu.

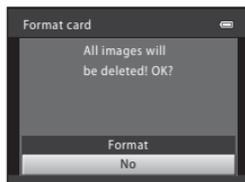

Notes on Formatting Internal Memory and Memory Cards

- Album icon settings ( 106) are reset to their default settings (number icons) when the internal memory or memory card is formatted.
- Do not turn the camera off or open the battery-chamber/memory card slot cover during formatting.
- Be sure to use this camera to format memory cards previously used in other devices the first time they are inserted into the COOLPIX S9100.

Language

MENU button →  (Setup menu) (📖 170) → Language

Choose one of 26 languages for display of camera menus and messages.

Čeština	Czech	Português	Portuguese
Dansk	Danish	Русский	Russian
Deutsch	German	Română	Romanian
English	(default setting)	Suomi	Finnish
Español	Spanish	Svenska	Swedish
Ελληνικά	Greek	Türkçe	Turkish
Français	French	Українська	Ukrainian
Indonesia	Indonesian	عربي	Arabic
Italiano	Italian	简体中文	Simplified Chinese
Magyar	Hungarian	繁體中文	Traditional Chinese
Nederlands	Dutch	日本語	Japanese
Norsk	Norwegian	한글	Korean
Polski	Polish	ภาษาไทย	Thai

TV Settings

MENU button →  (Setup menu) (📖 170) → TV settings

Adjust settings for connection to a television.

Video mode

Choose from **NTSC** and **PAL**.

HDMI

Choose an image resolution for HDMI output from **Auto** (default setting), **480p**, **720p**, or **1080i**. When **Auto** is selected, the option best suited to the high-definition TV to which the camera is connected is automatically selected from **480p**, **720p**, or **1080i**.

HDMI device control

Select whether or not the camera can receive signals from a TV that supports the HDMI-CEC standard when is connected to the TV via HDMI. When **On** (default setting) is selected, the TV's remote control can be used to control the camera during playback. → "Using a TV Remote Control (HDMI Device Control)" (📖 156)



HDMI and HDMI-CEC

HDMI (High-Definition Multimedia Interface) is a multimedia interface. HDMI-CEC (HDMI-Consumer Electronics Control) allows compatible devices to inter-operate.

Charge by Computer

MENU button →  (Setup menu) ( 170) → Charge by computer

Choose whether or not the battery inserted into the camera is charged when the camera is connected to a computer via the USB cable ( 162).

Auto (default setting)

When the camera is connected to a computer that is running, the battery inserted into the camera is automatically charged using power supplied by the computer.

Off

The battery inserted into the camera is not charged when the camera is connected to a computer.

Notes on Connecting the Camera to a Printer

- The battery cannot be charged with connection to a printer, even if the printer complies with the PictBridge standard.
- When **Auto** is selected for **Charge by computer**, it may be impossible to print images with direct connection of the camera to some printers. If the PictBridge startup screen is not displayed in the monitor after the camera is connected to a printer and turned on, turn the camera off and disconnect the USB cable. Set **Charge by computer** to **Off** and reconnect the camera to the printer.

Blink Warning

MENU button →  (Setup menu) (📖 170) → Blink warning

Specify whether or not the camera detects human subjects that have blinked using face detection (📖 56) when shooting in the following modes.

-  (auto) mode (when **Face priority** (📖 53) is selected for AF area mode option).
- In the following scene modes:
 - Scene auto selector (📖 62)
 -  (night portrait) (📖 65)
 - **Portrait** (📖 67)

On

When the camera detects that one or more human subjects may have blinked in an image captured using face detection, the **Did someone blink?** screen is displayed in the monitor.

The face of the human subject that may have closed his/her eyes is framed by a yellow border. Should this occur, check the image and determine whether or not another image should be captured.

See "Operating the Blink Warning Screen" (📖 189) for more information.

Off (default setting)

Blink warning is not enabled.

Note on Blink Warning

Blink warning does not function when using continuous shooting mode or smile timer (📖 37).

Operating the Blink Warning Screen

When the **Did someone blink?** screen shown on the right is displayed in the monitor, the operations described below are available.

If no operations are performed within a few seconds, the camera automatically returns to shooting mode.



Function	Control	Description
Enlarge the detected face that blinked	T (Q)	Rotate the zoom control to T (Q).
Switch to full-frame playback mode	W (checkered flag)	Rotate the zoom control to W (checkered flag).
Select the face to be displayed		If the camera detects that more than one human subject blinked, press ◀ or ▶ to switch the display to another face.
Delete the image		Press the button.
Switch to shooting mode		Press the button or shutter-release button.

Reset All

MENU button →  (Setup menu) (📖 170) → Reset all

When **Reset** is selected, the camera's settings will be restored to their default values.

Basic Shooting Functions

Option	Default value
Flash mode (📖 32)	Auto
Self-timer (📖 35)	Off
Macro mode (📖 39)	Off
Creative slider adjustment (📖 41)	Off
Exposure compensation (📖 43, 44)	0.0

Shooting Menu

Option	Default value
Image mode (📖 47)	 4000x3000
White balance (📖 49)	Auto
Metering (📖 51)	Matrix
ISO sensitivity (📖 52)	Auto
AF area mode (📖 53)	Face priority
Autofocus mode (📖 60)	Single AF

Scene Mode

Option	Default value
Scene menu (📖 61)	Portrait
Hue adjustment in Food mode (📖 71)	Center
Panorama (📖 73)	Easy panorama (Normal (180°))
Pet portrait (📖 74)	Continuous

Night landscape Menu

Option	Default value
Night landscape (📖 64)	Hand-held

Night Portrait Menu

Option	Default value
Night portrait (📖 65)	Tripod

Backlighting Menu

Option	Default value
HDR (📖 66)	Off

Continuous Shooting Menu

Option	Default value
Continuous (📖 82)	Continuous H

Special Effects Menu

Option	Default value
Special effects (📖 85)	Soft

Movie Menu

Option	Default value
Movie options (📖 148)	HD 1080p★ (1920×1080)
Open with HS footage (📖 143)	On
Autofocus mode (📖 150)	Single AF
Electronic VR (📖 151)	On
Wind noise reduction (📖 151)	Off

Setup Menu

Option	Default value
Welcome screen (📖 171)	None
Photo info (📖 175)	Auto info
Image review (📖 175)	On
Brightness (📖 175)	3
Print date (📖 177)	Off

Option	Default value
Vibration reduction (📖 178)	On
Motion detection (📖 180)	Auto
AF assist (📖 181)	Auto
Digital zoom (📖 182)	On
Button sound (📖 183)	On
Shutter sound (📖 183)	On
Auto off (📖 184)	1 min
HDMI (📖 186)	Auto
HDMI device control (📖 186)	On
Charge by computer (📖 187)	Auto
Blink warning (📖 188)	Off

Others

Option	Default value
Paper size (📖 165, 166)	Default
Frame interval for Slide show (📖 121)	3 s

- Selecting **Reset all** also clears the current file number (📖 199) from memory. Numbering will continue from the lowest number available. To reset file numbering to "0001," delete all images saved in the internal memory or on the memory card (📖 31) before selecting **Reset all**.
- The following menu settings will remain unaffected when menus are reset with **Reset all**.

Shooting menu:

Preset manual data (📖 50) acquired for **White balance**

Playback menu:

Sequence display options (📖 129), **Choose key picture** (📖 129)

Setup menu:

Time zone and date (📖 172), **Language** (📖 186), **Video mode** under **TV settings** (📖 186)

Firmware Version

MENU button →  (Setup menu) ( 170) → Firmware version

View the current camera firmware version.



Maximizing Camera Life and Performance

To ensure continued enjoyment of this Nikon product, observe the following precautions when using or storing the device.

Keep dry

The device will be damaged if immersed in water or subjected to high humidity.

Do not drop

The product may malfunction if subjected to strong shock or vibration.

Handle the lens and all moving parts with care

Do not apply force to the lens, lens cover, monitor, memory card slot, or battery chamber. These parts are easily damaged. Applying force to the lens cover could result in camera malfunction or damage to the lens. Should the monitor break, care should be taken to avoid injury caused by broken glass and to prevent the liquid crystal from the display touching the skin or entering the eyes or mouth.

Do not point the lens at strong light sources for extended periods

Avoid pointing the lens at the sun or other strong light sources for extended periods when using or storing the camera. Intense light may cause deterioration of the CCD image sensor, producing a white blur effect in photographs.

Keep away from strong magnetic fields

Do not use or store this device in the vicinity of equipment that generates strong electromagnetic radiation or magnetic fields. Strong static charge or the magnetic fields produced by equipment such as radio transmitters could interfere with the monitor, damage data saved on the memory card, or affect the product's internal circuitry.

Avoid sudden changes in temperature

Sudden changes in temperature, such as when entering or leaving a heated building on a cold day, can cause condensation to form inside the device. To prevent condensation, place the device in a carrying case or a plastic bag before exposing it to sudden changes in temperature.

Turn the product off before removing or disconnecting the power source

Do not remove the battery while the product is on, or while images are being saved or deleted. Forcibly cutting power in these circumstances could result in loss of data or in damage to product memory or internal circuitry.

 **The Battery**

- Check the battery level before using the camera and replace or charge the battery if necessary. Do not continue charging once the battery is fully charged as this will result in reduced battery performance. Whenever possible, carry a fully charged spare battery when taking pictures on important occasions.
- Do not use the battery at ambient temperatures below 0°C (32°F) or above 40°C (104°F).
- Charge the battery indoors with an ambient temperature of 5°C to 35°C (41°F to 95°F) before use.
- When charging the COOLPIX S9100 using the Charging AC adapter EH-69P or a computer, the charge capacity may decrease at ambient temperatures 45°C to 60°C (113°F to 140°F).
- The battery is not charged at ambient temperatures below 0°C (32°F) or above 60°C (140°F).
- Note that the battery may become hot during use; wait for the battery to cool before charging. Failure to observe these precautions could damage the battery, impair its performance, or prevent it from charging normally.
- On cold days, the capacity of batteries tends to decrease. Be sure that the battery is fully charged before heading outside to take pictures in cold weather. Keep spare batteries in a warm place and exchange as necessary. Once warmed, a cold battery may recover some of its charge.
- Dirt on the battery terminals can prevent the camera from functioning. Should the battery terminals become dirty, wipe them off with a clean, dry cloth before use.
- If the battery will not be used for some time, insert it in the camera and run it flat before removing it for storage. The battery should be stored in a cool location with an ambient temperature of 15 to 25°C (59 to 77°F). Do not store the battery in hot or extremely cold locations.
- Always remove the battery from the camera or optional battery charger when it is not being used. When inserted, minute amounts of current are drawn from the battery even when not in use. This may result in excessive draining of the battery and complete loss of function. Turning the camera on or off while the battery is exhausted can result in reduced battery life.
- Recharge the battery at least once every six months and completely exhaust it before returning it to storage.
- After removing the battery from the camera or optional battery charger, replace the supplied terminal cover and store in a cool place.
- A marked drop in the time a fully-charged battery retains its charge, when used at room temperature, indicates that the battery needs to be replaced. Purchase a new EN-EL12 battery.
- Replace the battery when it no longer holds a charge. Used batteries are a valuable resource. Please recycle used batteries in accordance with local regulations.

Cleaning

Lens	Avoid touching glass parts with your fingers. Remove dust or lint with a blower (typically a small device with a rubber bulb attached to one end that is pumped to produce a stream of air out the other end). To remove fingerprints or other stains that cannot be removed with a blower, wipe the lens with a soft cloth, using a spiral motion that starts at the center of them and working toward the edges. If this fails, clean the lens using a cloth lightly dampened with commercial lens cleaner.
Monitor	Remove dust or lint with a blower. To remove fingerprints and other stains, clean the monitor with a soft, dry cloth, being careful not to apply pressure.
Body	Use a blower to remove dust, dirt, or sand, then wipe gently with a soft, dry cloth. After using the camera at the beach or other sandy or dusty environment, wipe off any sand, dust, or salt with a dry cloth lightly dampened with fresh water and dry thoroughly. Note that foreign matter inside the camera could cause damage not covered by the warranty.

Do not use alcohol, thinner, or other volatile chemicals.

Storage

Turn the camera off when not in use. Be sure that the power-on lamp is off before putting the camera away. Remove the battery if the camera will not be used for an extended period. Do not store the camera with naphtha or camphor moth balls, or in any of the following locations:

- Next to equipment that produces strong electromagnetic fields, such as televisions or radios
- Exposed to temperatures below -10°C (14°F) or above 50°C (122°F)
- Places that are poorly ventilated or subject to humidity of over 60%

To prevent mold or mildew, take the camera out of storage at least once a month. Turn the camera on and release the shutter a few times before putting the camera away again.

Notes on the Monitor

- The monitor may contain a few pixels that are always lit or that do not light. This is a characteristic common to all TFT LCD displays, and does not indicate a malfunction. Images saved using the product will not be affected.
- Images in the monitor may be difficult to see under bright lighting.
- The monitor is lit by an LED backlight. Should the monitor begin to dim or flicker, contact your Nikon-authorized service representative.

Optional Accessories

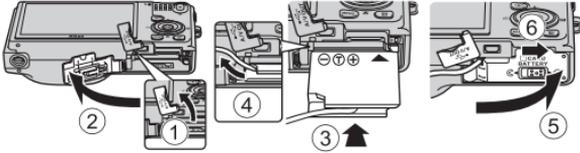
Rechargeable battery	Rechargeable Li-ion Battery EN-EL12 ¹
Charging AC adapter	Charging AC Adapter EH-69P ^{1, 2}
Battery charger	Battery Charger MH-65
AC adapter	<p>AC Adapter EH-62F (connect as shown)</p>  <p>Be sure that the power connector cord has been properly aligned in power connector and battery chamber grooves before closing the battery-chamber/memory card slot cover. If part of the cord runs out of the grooves, the cover or cord may be damaged when the cover is closed.</p>
USB cable	USB Cable UC-E6 ¹
Audio/video cable	Audio Video Cable EG-CP16 ¹

¹ Supplied with camera at time of purchase (see page 3 of the *Quick Start Guide*).

² When using in other countries, use a plug adapter (commercially available) as necessary. For more information about plug adapters, consult your travel agency.

Approved Memory Cards

The following Secure Digital (SD) memory cards have been tested and approved for use in this camera.

Memory cards with an SD Speed Class rating of 6 or faster are recommended for recording movies. Movie recording may stop unexpectedly when memory cards with a lower Speed Class rating are used.

	SD memory card	SDHC memory card ²	SDXC memory card ³
SanDisk	2 GB ¹	4 GB, 8 GB, 16 GB, 32 GB	64 GB
TOSHIBA	2 GB ¹	4 GB, 8 GB, 16 GB, 32 GB	64 GB
Panasonic	2 GB ¹	4 GB, 8 GB, 12 GB, 16 GB, 24 GB, 32 GB	48 GB, 64 GB
Lexar	2 GB ¹	4 GB, 8 GB, 16 GB, 32 GB	–

¹ If the memory card will be used with a card reader or similar device, check that device supports 2 GB cards.

² SDHC compliant.

If the memory card will be used with a card reader or similar device, check that device supports SDHC.



³ SDXC compliant.

If the memory card will be used with a card reader or similar device, check that device supports SDXC.



- Contact the manufacturer for details on the above cards.

File and Folder Names

Images, movies, or voice memos are assigned file names as follows.

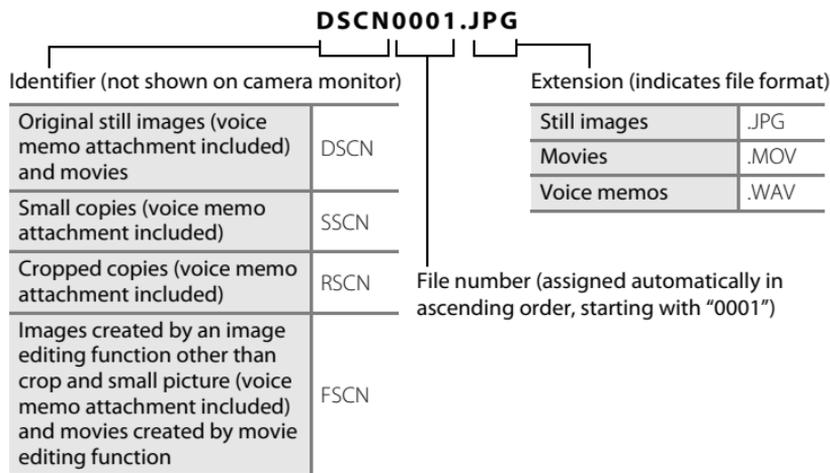

- Files are saved in folders named with a folder number followed by an identifier: "P_" plus a three-digit sequential number for images captured in **Panorama assist** scene mode (e.g. "101P_001"; 📖 78) and "NIKON" for all other images (e.g. "100NIKON"). When the number of files within a folder reaches 9999, a new folder will be created. File numbers will be assigned automatically starting with "0001."
- Voice memo file names have the same identifier and file number as the image to which the voice memo is attached.
- Files copied using **Copy>Selected images** are copied to the current folder, where they are assigned new file numbers in ascending order starting from the largest file number in memory. **Copy>All images** copies all folders from the source medium; file names do not change but new folder numbers are assigned in ascending order, starting from the largest folder number on the destination medium (📖 127).
- A single folder can hold up to 200 files; if the current folder already contains 200 files, a new folder, named by adding one to the current folder name, will be created the next time an image is captured. If the current folder is numbered 999 and contains 200 files, or an image is numbered 9999, no further images can be captured until the internal memory or memory card is formatted (📖 185), or a new memory card is inserted.

Error Messages

The following table lists the error messages and other warnings displayed in the monitor, as well as the solutions for dealing with them.

Display	Problem	Solution	
 (blinks)	Clock not set.	Set date and time.	172
 Battery exhausted.	Battery exhausted.	Charge or replace the battery.	14, 16
 Battery temperature high	Battery temperature is high.	Turn off camera, and allow battery to cool down before resuming use. After five seconds, this message will disappear, the monitor will turn off, and the power-on lamp will blink rapidly. After the lamp blinks for three minutes, the camera will turn off automatically. Pressing the power switch also turns off the camera.	19
 The camera will turn off to prevent overheating.	Memory card or inside of camera has become hot.	The camera turns off automatically. Leave the camera off until the memory card or the inside of the camera has cooled and then turn it on again.	–
 ● (● blinks red)	Camera cannot focus.	<ul style="list-style-type: none"> • Refocus. • Use focus lock. 	28, 29 55
 Please wait for the camera to finish recording.	Camera cannot perform other operations until saving is complete.	Wait until message clears from display automatically when saving is complete.	–
 Memory card is write protected.	Write-protect switch is in “lock” position.	Slide write-protect switch to “write” position.	23
 This card cannot be used.	Error accessing memory card.	<ul style="list-style-type: none"> • Use approved card. • Check that terminals are clean. • Confirm that memory card is correctly inserted. 	198 22
 This card cannot be read.			22

Display	Problem	Solution	
 Card is not formatted. Format card? Yes No	Memory card has not been formatted for use in COOLPIX S9100.	Formatting deletes all data saved on the memory card. Be sure to select No and make copies of any images which need to be kept before formatting the memory card. Select Yes and press the  button to format the memory card.	23
 Out of memory.	Memory card is full.	<ul style="list-style-type: none"> • Choose smaller image size. • Delete images. • Insert new memory card. • Remove memory card and use internal memory. 	47 31, 152 22 22
 Image cannot be saved.	Error occurred while saving image.	Format internal memory or memory card.	185
	Camera has run out of file numbers.	Insert a new memory card or format internal memory or memory card.	22, 185
	Image cannot be used for welcome screen.	<p>The following images cannot be registered as welcome screen.</p> <ul style="list-style-type: none"> • Images captured at an Image mode setting of  3968x2232 • Images captured with easy panorama • Images created using the small picture or crop functions that are 320 x 240 or smaller in size • Still images captured while recording high-definition or full high-definition movies 	171
	Insufficient space to save a copy.	Delete images from destination.	31, 152
 Album is full. No further pictures can be added.	200 images have already been added to album.	<ul style="list-style-type: none"> • Remove some images from album. • Add to other albums. 	104 101

Error Messages

Display	Problem	Solution	
 Sound file cannot be saved.	A voice memo cannot be attached to this file.	<ul style="list-style-type: none"> Voice memos cannot be attached to movies. Select an image captured with COOLPIX S9100. 	152 126
 Image cannot be modified.	Cannot edit selected image.	<ul style="list-style-type: none"> Select images that support editing function. Movies cannot be edited. 	130 –
 Cannot record movie.	Time out error while saving movie on the memory card.	Choose memory card with faster write speed.	22
 Memory contains no images.	No images in the internal memory or memory card.	<ul style="list-style-type: none"> Remove the memory card from the camera to play back images saved in the camera's internal memory. To copy image from internal memory to memory card, press the MENU button. The copy screen will be displayed and images in the internal memory can be copied to memory card. 	22 127
	No images have been added to the selected album.	<ul style="list-style-type: none"> Add images to the album. Choose an album to which images are added. 	101 103
	No images are contained in the category selected in auto sort mode.	Select the category containing the sorted images.	111
 File contains no image data.	File not created with the COOLPIX S9100.	File cannot be viewed on this camera. View file using a computer or the devices used to create or edit this file.	–
 This file cannot be played back.			
 All images are hidden.	No images available for a slide show.	–	121
 This image cannot be deleted.	Image is protected.	Disable protection.	122

Display	Problem	Solution	
 Travel destination is in the current time zone.	Destination in same time zone as home.	–	174
 Mode dial is not in the proper position.	The mode dial is not set to the correct position.	Rotate the mode dial to select the desired mode.	45
 The flash is lowered.	Flash is lowered in scene auto selector mode.	Slide the  (flash pop-up) control to make the flash pop up. To take pictures without using the flash, take pictures with the flash lowered.	33, 62
 Raise the flash.	Flash is lowered in  (night portrait) or  (backlighting) scene mode.	Slide the  (flash pop-up) control to make the flash pop up.	33, 65, 66
 Unable to create panorama.	Could not shoot using easy panorama.	Shooting with easy panorama may not be possible in the following situations. <ul style="list-style-type: none"> • When shooting does not end after a certain amount of time • When the camera is moved too fast • When the camera is not moved in a straight line in the panorama direction 	75
 Unable to create panorama. Pan the camera in one direction only.			
 Unable to create panorama. Pan the camera more slowly.			
Lens error 	Lens error.	Turn camera off and then on again. If error persists, contact retailer or Nikon-authorized service representative.	24
 Communications error	Error occurred during communication with printer.	Turn camera off and reconnect USB cable.	164
System error 	Error has occurred in camera's internal circuitry.	Turn camera off, remove and reinsert battery, and turn camera on. If error persists, contact retailer or Nikon-authorized service representative.	14, 19

Error Messages

Display	Problem	Solution	
 Printer error: check printer status.	Printer error.	Check printer. After solving the problem, select Resume and press the  button to resume printing.*	–
 Printer error: check paper	Specified size of paper is not loaded in printer.	Load the specified paper, select Resume , and press the  button to resume printing.*	–
 Printer error: paper jam	Paper has jammed in printer.	Remove the jammed paper, select Resume , and press the  button to resume printing.*	–
 Printer error: out of paper	No paper is loaded in printer.	Load the specified paper, select Resume , and press the  button to resume printing.*	–
 Printer error: check ink	Ink error.	Check ink, select Resume , and press the  button to resume printing.*	–
 Printer error: out of ink	Running out of ink or ink cartridge is empty.	Replace ink cartridge, select Resume , and press the  button to resume printing.*	–
 Printer error: file corrupt	An error caused by the image file has occurred.	Select Cancel and press the  button to cancel printing.	–

* See the documentation provided with your printer for further guidance and information.

Troubleshooting

If the camera fails to function as expected, check the list of common problems below before consulting your retailer or Nikon-authorized service representative.

Display, Settings, and Power Supply

Problem	Cause/Solution	
The battery inserted in the camera cannot be charged.	<ul style="list-style-type: none"> • Confirm all connections. 	16
	<ul style="list-style-type: none"> • Off is selected for Charge by computer in the setup menu. 	187
	<ul style="list-style-type: none"> • When charging by connecting the camera to a computer, battery charging stops when the camera is turned off. 	162
	<ul style="list-style-type: none"> • When charging by connecting the camera to a computer, battery charging stops when the computer is suspended (sleeping), and the camera may turn off. 	162
	<ul style="list-style-type: none"> • Depending upon computer specifications, settings, and status, charging the battery inserted in the camera may not be possible via computer connection. 	–
Camera cannot be turned on.	<ul style="list-style-type: none"> • Battery is exhausted. 	24
	<ul style="list-style-type: none"> • The camera cannot be turned on while connected to an electrical outlet via the Charging AC Adapter. 	16
Camera turns off without warning.	<ul style="list-style-type: none"> • Battery is exhausted. 	24
	<ul style="list-style-type: none"> • Camera has turned off automatically to save power. 	184
	<ul style="list-style-type: none"> • The camera and battery may not perform properly if they are cold. 	195
	<ul style="list-style-type: none"> • The camera turns off if the Charging AC Adapter is connected while the camera is on. 	16
	<ul style="list-style-type: none"> • The camera turns off if the USB cable connecting it to a computer or printer is disconnected. Reconnect the USB cable. 	158, 160, 164
	<ul style="list-style-type: none"> • Inside of the camera has become hot. Leave the camera off until the inside of the camera has cooled, and then try turning it on again. 	–
Monitor is blank.	<ul style="list-style-type: none"> • Camera is off. 	19
	<ul style="list-style-type: none"> • Standby mode for saving power: press the power switch, shutter-release button,  button, or  (movie-record) button, or rotate the mode dial. 	4, 10, 19, 30
	<ul style="list-style-type: none"> • When flash lamp blinks, wait until flash has charged. 	34
	<ul style="list-style-type: none"> • Camera and computer are connected via USB cable. 	158
	<ul style="list-style-type: none"> • Camera and TV are connected via A/V cable or HDMI cable. 	155
Monitor is hard to read.	<ul style="list-style-type: none"> • Adjust monitor brightness. 	175
	<ul style="list-style-type: none"> • Monitor is dirty. Clean monitor. 	196

Problem	Cause/Solution	
Date and time of recording are not correct.	<ul style="list-style-type: none"> • If camera clock has not been set, "Date not set" indicator blinks with shooting and movie recording. Images and movies saved before clock is set are dated "00/00/0000 00:00" or "01/01/2011 00:00" respectively. Set the correct time and date from the Time zone and date option in the setup menu. • Check camera clock regularly against more accurate timepieces and reset as required. 	20, 172 172
No indicators displayed in monitor.	Hide info is selected for Photo info . Select Show info .	175
Print date not available.	Camera clock has not been set.	20, 172
Date not imprinted on images even when Print date is enabled.	<ul style="list-style-type: none"> • The current shooting mode is one that does not support Print date. • The date cannot be imprinted on movies. • The date cannot be imprinted on still images saved during movie recording. 	177 – –
Screen for setting time zone and date is displayed when camera is turned on.	Clock battery is exhausted; all settings were restored to their default values.	20, 173
Camera settings reset.		
Monitor turns off, and the power-on lamp blinks rapidly.	Battery temperature is high. Turn off camera and allow battery to cool down before resuming use. After the lamp blinks for three minutes, the camera will turn off automatically. Pressing the power switch also turns off the camera.	19
Camera becomes hot.	The camera may become hot when shooting movies for an extended period of time or when the camera is used in a hot area; this is not a malfunction.	–

Electronically Controlled Cameras

In extremely rare instances, unusual characters may appear in the monitor and the camera may stop functioning. In most cases, this phenomenon is caused by a strong external static charge. Turn the camera off, remove and replace the battery, then turn the camera on again. In the event of continued malfunction, contact your retailer or Nikon-authorized service representative. Note that disconnecting the power source as described above may result in the loss of any data not saved to internal memory or the memory card at the time the problem occurred. Data already saved will not be affected.

Shooting

Problem	Cause/Solution	
Cannot switch to shooting mode.	Disconnect HDMI cable or USB cable.	155, 158, 164
No image captured when the shutter-release button is pressed.	<ul style="list-style-type: none"> When camera is in playback mode, press the  button or shutter-release button. When menus are displayed, press the MENU button. Battery is exhausted. When flash lamp blinks, flash is charging. 	4, 30 12 24 34
Camera cannot focus.	<ul style="list-style-type: none"> Subject is too close. Try shooting using macro mode, or the Scene auto selector or Close-up scene modes. The intended subject is one with which autofocus does not perform well. Set AF assist in the setup menu to Auto. Turn camera off and then on again. 	39, 61, 70 29 181 19
Images are blurred.	<ul style="list-style-type: none"> Use flash. Enable vibration reduction or motion detection. Use BSS (best shot selector). Use tripod and self-timer. 	32 178, 180 82 35
Bright specks appear in images captured with flash.	Flash is reflecting off particles in air. Lower the flash or set the flash mode setting to  (off).	34
Flash does not fire.	<ul style="list-style-type: none"> The flash is lowered, or flash mode is set to  (off). Scene mode with which the flash does not fire is selected. Flash is not fully raised. Do not hold down the flash. Another function that restricts flash is enabled. 	32 64 26 87
Digital zoom cannot be used.	<ul style="list-style-type: none"> Digital zoom is set to Off in the setup menu. Another function that disables digital zoom is enabled. 	182
Image mode not available.	<ul style="list-style-type: none"> Another function that restricts the Image mode option is enabled. Available image modes differ according to the current shooting mode. 	87 47

Troubleshooting

Problem	Cause/Solution	
No sound when shutter is released.	Off is selected for Sound settings>Shutter sound in setup menu. No sound is heard with some shooting modes and settings, even when On is selected.	183
AF-assist illuminator does not light.	Off is selected for the AF assist option in the setup menu. AF-assist illuminator may not light depending on the position of the focus area or the current scene mode, even when Auto is selected.	64-73, 181
Images appear smeared.	Lens is dirty. Clean lens.	196
Colors are unnatural.	White balance or hue is not adjusted properly.	40, 49, 71
Randomly spaced bright pixels ("noise") appear in image.	Shutter speed is too slow or ISO sensitivity is high as the subject is dark. Noise can be reduced by: <ul style="list-style-type: none"> • Using flash. • Specifying a lower ISO sensitivity setting. 	32 52
Images are too dark (underexposed).	<ul style="list-style-type: none"> • The flash is lowered, or the flash mode is set to  (off). • Flash window is blocked. • Subject is beyond flash range. • Adjust exposure compensation. • Increase ISO sensitivity. • Subject is backlit. Select  (backlighting) or set the flash mode to  (fill flash). 	32 26 32 43, 44 52 32, 66
Images are too bright (overexposed).	Adjust exposure compensation.	43, 44
Unexpected results when flash set to  (auto with red-eye reduction).	When using  (auto with red-eye reduction) or  (night portrait) to take pictures using the flash, In-Camera Red Eye Fix may be applied to areas not affected by red-eye. Use any shooting mode other than  (night portrait), change the flash mode to any setting other than  (auto with red-eye reduction), and then try taking a picture again.	32, 65

Problem	Cause/Solution	
Saving images takes time.	It may take more time to save images in the following situations. <ul style="list-style-type: none"> • When the noise reduction function is in operation. • When the flash mode is set to  (auto with red-eye reduction). • When taking pictures in the following scene modes. <ul style="list-style-type: none"> -  (night landscape) -  (night portrait) -  (backlighting) (when HDR is set to On) - Portrait • When using continuous shooting mode. 	34 32 64 65 66 67 80
A ring-shaped belt or rainbow-colored stripe appears in the monitor or images.	When shooting with backlighting or when a very strong light source (such as sunlight) is in the frame, a ring-shaped belt or rainbow-colored stripe (ghosting) may occur. Change the position of the light source, or frame the picture so that the light source does not enter the frame and try again.	–

Playback

Problem	Cause/Solution	
File cannot be played back.	<ul style="list-style-type: none"> • File or folder was overwritten or renamed by computer or other make of camera. • The COOLPIX S9100 is not able to play back movies recorded with another make or model of digital camera. 	– 152
Cannot zoom in on image.	<ul style="list-style-type: none"> • Playback zoom cannot be used with movies, small pictures, or images that have been cropped to a size of 320 × 240 or smaller. • The COOLPIX S9100 may not be able to zoom in on images captured with another make or model of digital camera. 	–
Cannot record or play back voice memos.	<ul style="list-style-type: none"> • Voice memos cannot be attached to movies. • Voice memos can only be attached to images captured with the COOLPIX S9100. Voice memos attached to images using another camera cannot be played back on this camera. 	152 126

Problem	Cause/Solution	
<p>Cannot use quick retouch, D-Lighting, skin softening, filter effects, frame, small picture, or crop.</p>	<ul style="list-style-type: none"> • These options cannot be used with movies. • Images captured at an Image mode setting of  3968x2232 and still images captured while recording high-definition or full high-definition movies cannot be edited. • Select images that support quick retouch, D-Lighting, skin softening, filter effects, frame, small picture, or crop. • The COOLPIX S9100 is not able to edit images captured with another make or model of digital camera. 	<p>152 47 131 130</p>
<p>Images not displayed on television.</p>	<ul style="list-style-type: none"> • Video mode or HDMI is not correctly set in the TV settings setup menu. • Cables are connected to the HDMI mini connector (Type C) and to the USB/audio/video output connector simultaneously. • Memory card contains no images. Replace the memory card. Remove the memory card to play back images from the internal memory. 	<p>186 155, 158 22</p>
<p>Album icons are reset to their default icons, images added to albums cannot be displayed in favorite pictures mode.</p>	<p>Data saved in the internal memory or on the memory card may not be played back correctly if overwritten by a computer.</p>	<p>–</p>
<p>The saved images are not displayed in auto sort mode.</p>	<ul style="list-style-type: none"> • The desired image was sorted to a category other than the category currently displayed. • Images saved by a camera other than the COOLPIX S9100 and images copied using the Copy option cannot be displayed in auto sort mode. • Images saved in the internal memory or on the memory card may not be played back correctly if overwritten by a computer. • Up to 999 images and movies in total can be added to each category. If the desired category already contains 999 images or movies in total, new images or movies cannot be added. 	<p>109 111 – 111</p>

Problem	Cause/Solution	
Nikon Transfer 2 does not start when camera is connected.	<ul style="list-style-type: none"> • Camera is off. • Battery is exhausted. • USB cable is not correctly connected. • Camera is not recognized by the computer. • Confirm system requirements. • Computer is not set to start Nikon Transfer 2 automatically. For more information on Nikon Transfer 2, refer to help information contained in ViewNX 2.	19 24 158 – 157 161
The PictBridge startup screen is not displayed when the camera is connected to a printer.	With some PictBridge-compatible printers, the PictBridge startup screen may not be displayed and it may be impossible to print images when Auto is selected for the Charge by computer option in the setup menu. Set the Charge by computer option to Off and reconnect the camera to the printer.	187
Images to be printed are not displayed.	<ul style="list-style-type: none"> • Memory card contains no images. Replace the memory card. • Remove the memory card to print images from the internal memory. 	22
Cannot select paper size with camera.	Paper size cannot be selected from the camera in the following situations, even when printing from a PictBridge-compatible printer. Use the printer to select paper size. <ul style="list-style-type: none"> • The printer does not support the paper sizes specified by the camera. • The printer automatically selects the paper size. 	165, 166 –

Specifications

Nikon COOLPIX S9100 Digital Camera

Type	Compact digital camera
Effective pixels	12.1 million
Image sensor	¹ /2.3-in. type CMOS; approx. 12.75 million total pixels
Lens	18× optical zoom, NIKKOR lens
Focal length	4.5-81.0mm (angle of view equivalent to that of 25-450 mm lens in 35mm [135] format)
f/-number	f/3.5-5.9
Construction	12 elements in 11 groups
Digital zoom	Up to 4× (angle of view equivalent to that of approx. 1800 mm lens in 35mm [135] format)
Vibration reduction	Combination of image sensor shift and electronic VR (still pictures) Electronic VR (movies)
Autofocus (AF)	Contrast-detect AF
Focus range (from lens)	<ul style="list-style-type: none">• [W]: Approx. 50 cm (1 ft. 8 in.) to ∞, [T]: Approx. 1.5 m (5 ft.) to ∞• Macro mode: Approx. 4 cm (1.6 in.) to ∞ (wide-angle position)
Focus-area selection	Face priority, auto (9-area automatic selection), manual with 99 focus areas, center, subject tracking
Monitor	7.5 cm (3-in.), approx. 921k-dot, wide viewing angle TFT LCD with anti-reflection coating and 5-level brightness adjustment
Frame coverage (shooting mode)	Approx. 97% horizontal and 97% vertical
Frame coverage (playback mode)	Approx. 100% horizontal and 100% vertical
Storage	
Media	Internal memory (approx. 74 MB), SD/SDHC/SDXC memory card
File system	DCF, Exif 2.3, and DPOF compliant
File formats	Still pictures: JPEG Sound files (Voice Memo): WAV Movies: MOV (Video: H.264/MPEG-4 AVC, Audio: AAC stereo)
Image size (pixels)	<ul style="list-style-type: none">• 12M (High) [4000 × 3000★]• 12M [4000 × 3000]• 8M [3264 × 2448]• 5M [2592 × 1944]• 3M [2048 × 1536]• PC [1024 × 768]• VGA [640 × 480]• 16:9 [3968 × 2232]
ISO sensitivity (Standard output sensitivity)	<ul style="list-style-type: none">• ISO 160, 200, 400, 800, 1600, 3200• Auto (auto gain from ISO 160 to 800)• Fixed range auto (ISO 160 to 400)• High-speed continuous (ISO 160 to 3200)

Exposure	
Metering	256-segment matrix, center-weighted, spot (digital zoom 2x or more)
Exposure control	Programmed auto exposure with motion detection and exposure compensation (-2.0 to +2.0 EV in steps of 1/3 EV)
Shutter	Mechanical and CMOS electronic shutter
Speed	<ul style="list-style-type: none"> • 1/2000-1 s • 1/4000-1/125 s (Continuous H: 120 fps) • 1/4000-1/60 s (Continuous H: 60 fps) • 4 s (Fireworks show scene mode)
Aperture	Electronically-controlled ND filter (-2 AV) selection
Range	2 steps (f/3.5 and f/7 [W])
Self-timer	Can be selected from 10 and 2 seconds duration
Built-in flash	
Range (approx.) (ISO sensitivity: Auto)	[W]: 0.5 to 4.0 m (1 ft. 8 in. to 13 ft.) [T]: 1.5 to 2.5 m (5 ft. to 8 ft. 2 in.)
Flash control	TTL auto flash with monitor preflashes
Interface	Hi-Speed USB
Data transfer protocol	MTP, PTP
Video output	Can be selected from NTSC and PAL
HDMI output	Can be selected from Auto , 480p , 720p , and 1080i
I/O terminal	Audio/video (A/V) output; digital I/O (USB) HDMI mini connector (Type C) (HDMI output)
Supported languages	Arabic, Chinese (Simplified and Traditional), Czech, Danish, Dutch, English, Finnish, French, German, Greek, Hungarian, Indonesian, Italian, Japanese, Korean, Norwegian, Polish, Portuguese, Romanian, Russian, Spanish, Swedish, Thai, Turkish, Ukrainian
Power sources	One Rechargeable Li-ion Battery EN-EL12 (supplied) AC Adapter EH-62F (available separately)
Charging time	Approx. 3 hours and 50 minutes (when using Charging AC Adapter EH-69P and when no charge remains)
Battery life (EN-EL12)	Still pictures*: Approx. 270 shots Movies: Approx. 1 h 20 min (HD 1080p★)
Tripod socket	1/4 (ISO 1222)
Dimensions (W × H × D)	Approx. 104.8 × 62.0 × 34.6 mm (4.2 × 2.5 × 1.4 in.) (excluding projections)
Weight	Approx. 214 g (7.6 oz) (including battery and SD memory card)
Operating environment	
Temperature	0 to 40°C (32 to 104°F)
Humidity	Less than 85% (no condensation)

Specifications

- Unless otherwise stated, all figures are for a camera with a fully-charged Rechargeable Li-ion Battery EN-EL12 operated at an ambient temperature of 25°C (77°F).
- * Based on Camera and Imaging Products Association (CIPA) standards for measuring the life of camera batteries. Measured at 23 (±2)°C (73 (±4)°F); zoom adjusted with each shot, flash fired with every other shot, image mode set to  4000×3000. Battery life may vary depending on shooting interval and length of time menus and images are displayed.

Rechargeable Li-ion Battery EN-EL12

Type	Rechargeable lithium-ion battery
Rated capacity	DC 3.7 V, 1050 mAh
Operating temperature	0 to 40°C (32 to 104°F)
Dimensions (W × H × D)	Approx. 32 × 43.8 × 7.9 mm (1.3 × 1.7 × 0.3 in.)
Weight	Approx. 22.5 g (0.8 oz) (excluding terminal cover)

Charging AC Adapter EH-69P

Rated input	AC 100-240 V, 50/60 Hz, 0.068-0.042 A
Rated capacity	6.8-10.1 VA
Rated output	DC 5.0 V, 550 mA
Operating temperature	0 to 40°C (32 to 104°F)
Dimensions (W × H × D)	Approx. 55 × 22 × 54 mm (2.2 × 0.9 × 2.2 in.) (excluding plug adapter) For Argentina: Approx. 55 × 59 × 63 mm (2.2 × 2.4 × 2.5 in.)
Weight	Approx. 55 g (2.0 oz) (excluding plug adapter) For Argentina: Approx. 80 g (2.9 oz)

Specifications

Nikon will not be held liable for any errors this manual may contain. The appearance of this product and its specifications are subject to change without notice.

Supported Standards

- **DCF:** Design Rule for Camera File System is a standard widely used in the digital camera industry to ensure compatibility among different makes of camera.
- **DPOF:** Digital Print Order Format is an industry-wide standard that allows images to be printed from print orders saved on memory cards.
- **Exif version 2.3:** This camera supports Exchangeable image file format (Exif) version 2.3 for digital still cameras, a standard that allows information saved with photographs to be used for optimal color reproduction when images are output from Exif-compliant printers.
- **PictBridge:** A standard developed cooperatively by the digital camera and printer industries, allowing photographs to be output directly to a printer without connecting the camera to a computer.

Index

Symbols

AE/AF-L 79

● (▶) movie record)-button 10

T (tele) 27

W (wide) 27

▶ Playback button 10

📷 Shooting mode button 10

☒ Exposure compensation 44

📷 Auto mode 24

AUTO Auto sort mode 109

📷 Backlighting 66

MENU button 12, 46, 99, 116, 146, 170

OK button 11

📷 Continuous shooting mode 80, 82

🗑 Delete button 31, 126, 152

📷 Favorite pictures mode 101

⚡ Flash mode 33

⚡🔊 Flash pop-up control 4, 9, 32

📅 List by date mode 113

📷 Macro mode 39

📷 Movie menu 146

📷 Night landscape 64

📷 Night portrait 65

▶ Playback button 30

▶ Playback menu 115

▶ Playback mode 30

🔍 Playback zoom 97

📷 Scene 61

📷 Scene Auto Selector 62

🕒 Self timer 35

🔧 Setup 169

📷 Shooting menu 46

EFFECTS Special Effects Mode 85

🖼 Thumbnail playback 94, 96

A

AC adapter 197

AF area mode 53

AF assist 181

Album 106

Aperture 28

Aperture value 28

Audio/video cable 155, 197

Audio/video-in jack 155

Auto 32, 49

Auto mode 24

Auto off 184

Auto sort menu 112

Auto sort mode 109

Autofocus 39, 60, 150

Autofocus mode 60, 150

AV cable 155

B

Backlighting 📷 66

Battery 14, 16, 173

Battery chamber 5

Battery charger 18, 197

Battery latch 5, 14

Battery level 24

Battery-chamber/memory card slot cover 14, 22

Beach 📷 69

Best shot selector 83

Black and white copy 📷 73

Blink warning 188, 189

Brightness 175

BSS 83

Button sound 183

C

Calendar display 96

Center-weighted 51

Charge by computer 187

Charge lamp 17, 162

Charger 16, 197

Charging AC Adapter 16, 197

Choose key picture 129

Close-up 📷 70

Cloudy 49

Compression ratio 47

Computer 157

Connector cover 5

Continuous menu 82
 Continuous shooting mode 80
 Copying images 127
 Creative slider 41
 Crop 139

D

Date and time 20, 172
 Date format 21, 172
 Daylight 49
 Daylight saving time 20, 173
 Delete 31, 93, 126, 152
 Digital zoom 27, 182
 Direct print 163
 D-Lighting 133
 DPOF 215
 DPOF print 168
 DSCN 199
 Dusk/dawn  70

E

Easy panorama 73, 75
 EH-69P 16
 Electronic VR 151
 EN-EL12 14, 16
 Exposure compensation 40, 44
 Extension 199
 Eyelet for camera strap 5

F

Face detection 56
 Face priority 53
 Favorite pictures 101
 Favorite pictures menu 105
 Favorite pictures mode 103
 File name 199
 Fill flash 32
 Filter effects 135
 Fireworks show  72
 Firmware version 193
 Fixed range auto 52
 Flash 49
 Flash lamp 34

Flash mode 32
 Flash off 32
 Flash pop-up control 4, 9, 32
 Fluorescent 49
 Focus 28, 53
 Focus indicator 7
 Focus lock 55
 Folder name 199
 Food  71
 Format internal memory 185
 Format memory card 23, 185
 Formatting 23, 185
 Frame 137
 FSCN 199
 Full-frame playback 30, 89
 Full-time AF 60, 150

H

HDMI cable 155
 HDMI device control 186
 High-speed continuous 83
 HS movie 143
 Hue 40

I

Identifier 199
 Image copy 127
 Image mode 47, 48
 Image review 175
 Image size 47
 Imprinting Date and Time 177
 Incandescent 49
 Internal memory 22
 Internal memory indicator 25
 ISO sensitivity 34, 52

J

JPG 199

L

Landscape  67
 Language 186
 Lens 4, 212
 Lens cover 4

List by date menu 114

List by date mode 113

M

Macro mode 39

Matrix 51

Maximum movie length 149

Memory capacity 24

Memory card 22, 198

Memory card slot 22

Metering 51

Microphone 4

Monitor 6, 196

Monitor settings 175

More on Shooting 45

Motion detection 180

MOV 199

Movie Editing 153

Movie menu 146

Movie options 146

Movie playback 152

Movie recording 140

Movie shooting button 10

Multi-shot 16 83

Museum  72

N

Night landscape  64

Night portrait  65

Nikon Transfer 2 157, 158

Number of exposures remaining 24, 48

O

Open with HS footage 143

Optical zoom 27

Optional accessories 197

Output connector 155

P

Panorama 73

Panorama assist 73, 78

Panorama Maker 5 157, 161

Paper size 165, 166

Party/indoor  68

Pet portrait auto release 74

Pet portrait  74

Photo info 175

PictBridge 163, 215

Playback 30, 94, 96, 97, 126, 152

Playback menu 115

Playback mode 30

Playback mode menu 99

Playback zoom 97

Portrait  67

Power 19, 20, 24

Power switch 19, 20, 24

Power-on lamp 19, 20, 24

Preset manual 50

Pre-shooting cache 84

Print 117, 165, 166

Print date 177

Print order 117

Print order date option 118, 120

Printer 163

Protect 122

Q

Quick retouch 132

R

Rechargeable battery 197

Rechargeable Li-ion battery 14, 16, 197

Recording movies 140

Recording slow motion movies 143

Red-eye reduction 32

Remove from favorites 104

Reset all 190

Rotary multi selector 11

Rotate image 124

RSCN 199

S

Scene auto selector 62

Scene auto selector  62

Scene mode 61, 64

Self-timer 35

Self-timer lamp 36

Sequence display options 129
Setup menu 169
Shooting 24, 26, 28
Shooting info 11
Shooting information 91
Shooting menu 46
Shutter sound 183
Shutter speed 28
Shutter-release button 9, 28
Single AF 60, 150
Skin softening 134
Slide show 121
Slow sync 32
Small picture 138
Snow  69
Sound settings 183
Speaker 4
Special effect menu 85
Special Effects Mode **EFFECTS** 85
Sports  68
SSCN 199
Strap 13
Sunset  69

I

Television 155
Thumbnail display 94
Thumbnail playback 94
Time difference 174
Time zone 172, 174
Time zone and date 172
Tripod socket 5, 213
TV 155
TV Settings 186

U

USB cable 158, 164, 197
USB/audio/video output connector 157, 158

V

Vibration reduction 178
Video mode 186

ViewNX 2 157, 161
Voice memo 125
Volume 126, 152

W

WAV 199
Welcome screen 171
White balance 49
Wind Noise Reduction 151

Z

Zoom control 152
Zoom in 27
Zoom out 27



A series of horizontal dashed lines spanning the width of the page, intended for handwriting practice.



A series of 15 horizontal dashed lines, evenly spaced, providing a guide for handwriting practice. The lines are parallel and extend across the width of the page.



A series of horizontal dashed lines spanning the width of the page, intended for handwriting practice. There are 15 lines in total, starting from the top right and extending to the left edge of the page.

Nikon

No reproduction in any form of this manual, in whole or in part (except for brief quotation in critical articles or reviews), may be made without written authorization from NIKON CORPORATION.



NIKON CORPORATION

© 2011 Nikon Corporation

CT1A01(11)
6MM05511-01