

OLYMPUS[®]

DIGITAL CAMERA

E-5

INSTRUCTION MANUAL

Basic guide

P. 2

Review the camera part names, the basic steps for shooting and playback, and the basic operations.

Table of Contents P. 23

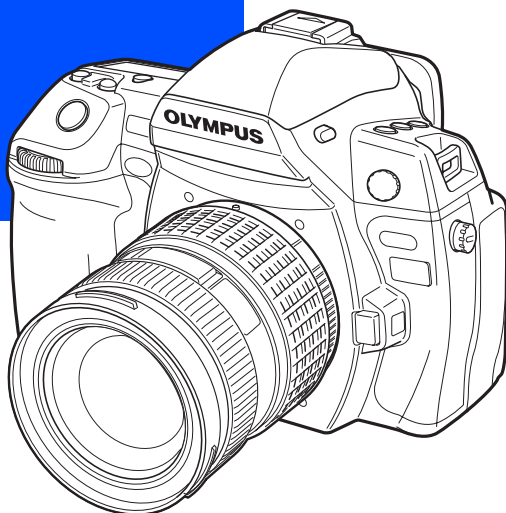

- Thank you for purchasing an Olympus digital camera. Before you start to use your new camera, please read these instructions carefully to enjoy optimum performance and a longer service life. Keep this manual in a safe place for future reference.
- We recommend that you take test shots to get accustomed to your camera before taking important photographs.
- The screen and camera illustrations shown in this manual were produced during the development stages and may differ from the actual product.
- The contents in this manual are based on firmware version 1.0 for this camera. If there are addition and/or modification of functions due to firmware update for the camera, the contents will differ. For the latest information, please visit the Olympus website.

Camera

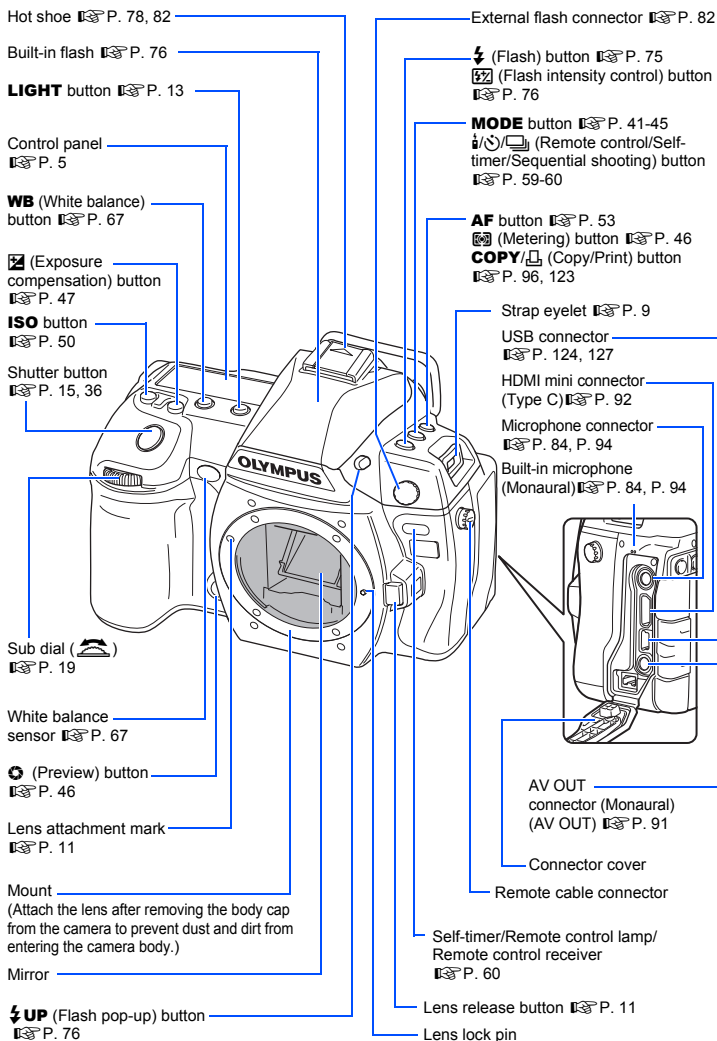

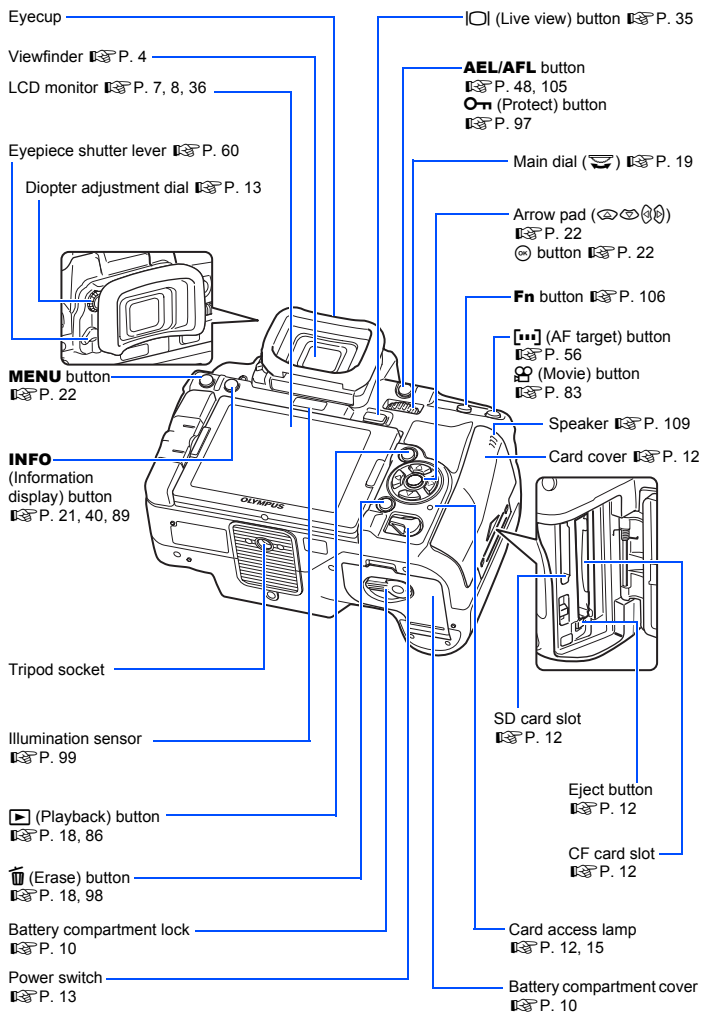

Viewfinder

AF target  P. 56

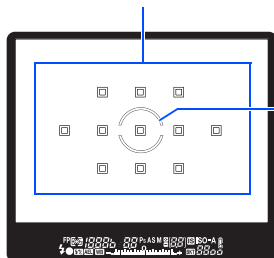

Spot metering area
 P. 46

Aperture value

 P. 41-45

Shutter speed

 P. 41-45

Super FP flash

 P. 79

Metering mode

 P. 46

Shooting mode  P. 41-45



Number of storable
sequential pictures
 P. 59

Image stabilizer  P. 62

ISO sensitivity

 P. 50



FP 



18888

F8.8

Ps ASM

88

ISO-A

0

BKT

8800

White balance
(Displayed when set
to a setting other than
auto white balance.)
 P. 66



Auto bracket
 P. 49, 51, 69, 77

ISO sensitivity value
 P. 50

AE lock  P. 48

Battery check
 P. 13

Flash intensity control
 P. 76

Exposure level indicator  P. 44
Exposure compensation indicator  P. 47
Horizontal level indicator  P. 110

AF confirmation mark
 P. 15, 36

Flash  P. 73

(blinks: charging in progress, lights up: charging completed)

Control panel

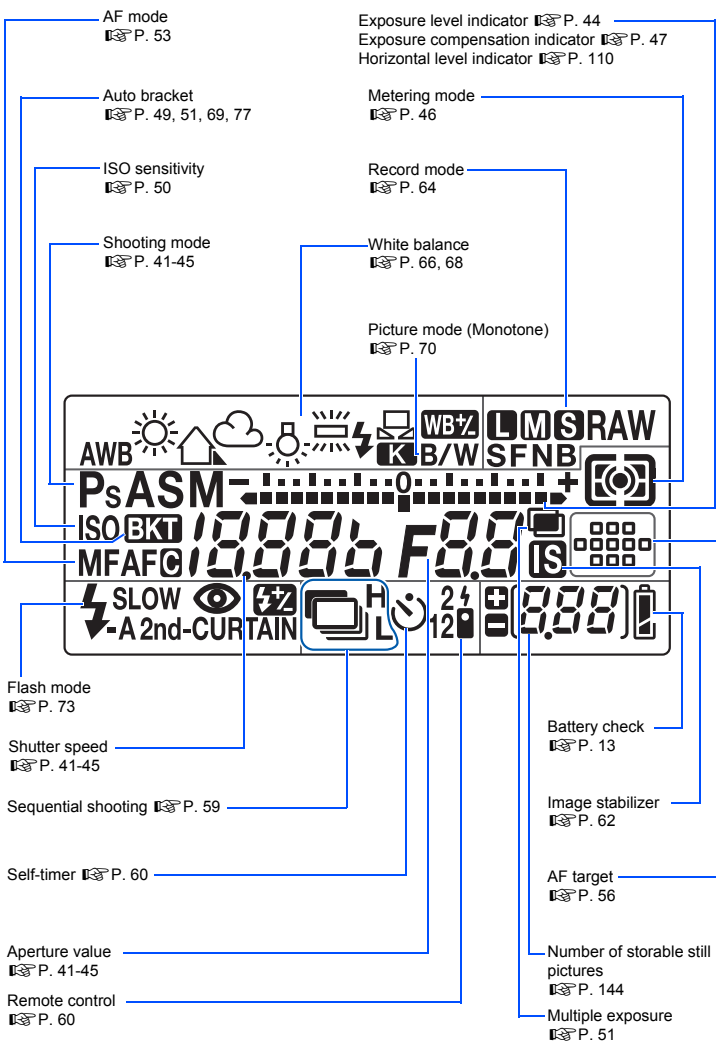

Super control panel

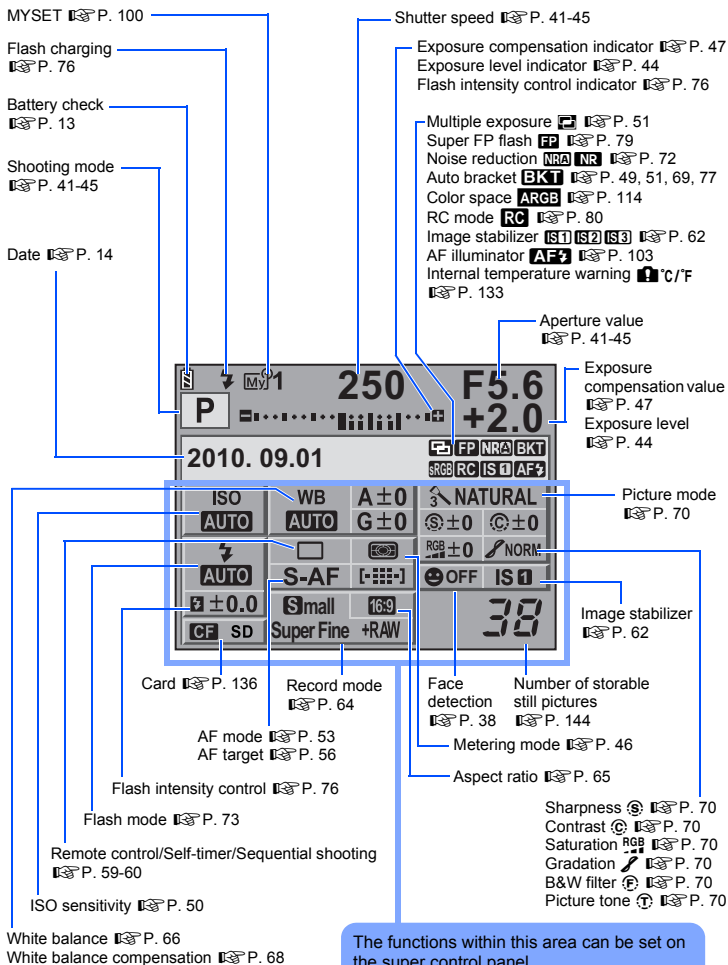

The following screen allows the display and setting of shooting settings at the same time and is called the super control panel. Press the **INFO** button to display the super control panel on the LCD monitor.

☞ “Setting while looking at the super control panel” (P. 21)



The functions within this area can be set on the super control panel.

LCD monitor (Live view)

You can use the LCD monitor to view the subject while shooting. Press the  button to use live view.  "Using live view" (P. 35)

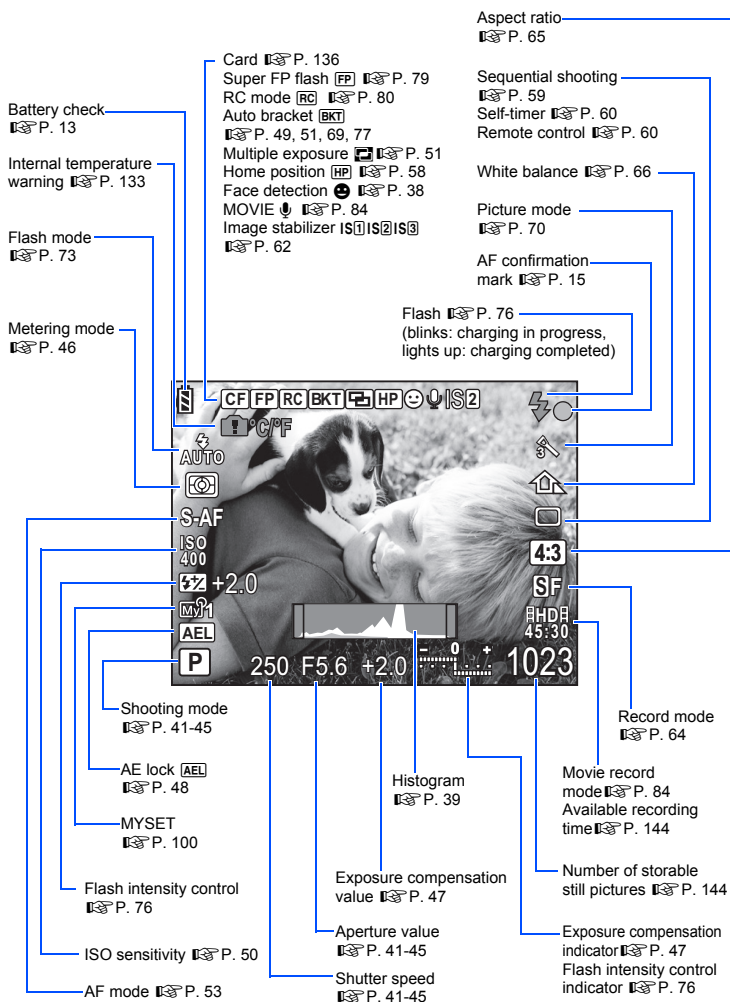

LCD monitor (Playback)

You can switch the monitor display using the **INFO** button.

☞ “Information display” (P. 89)

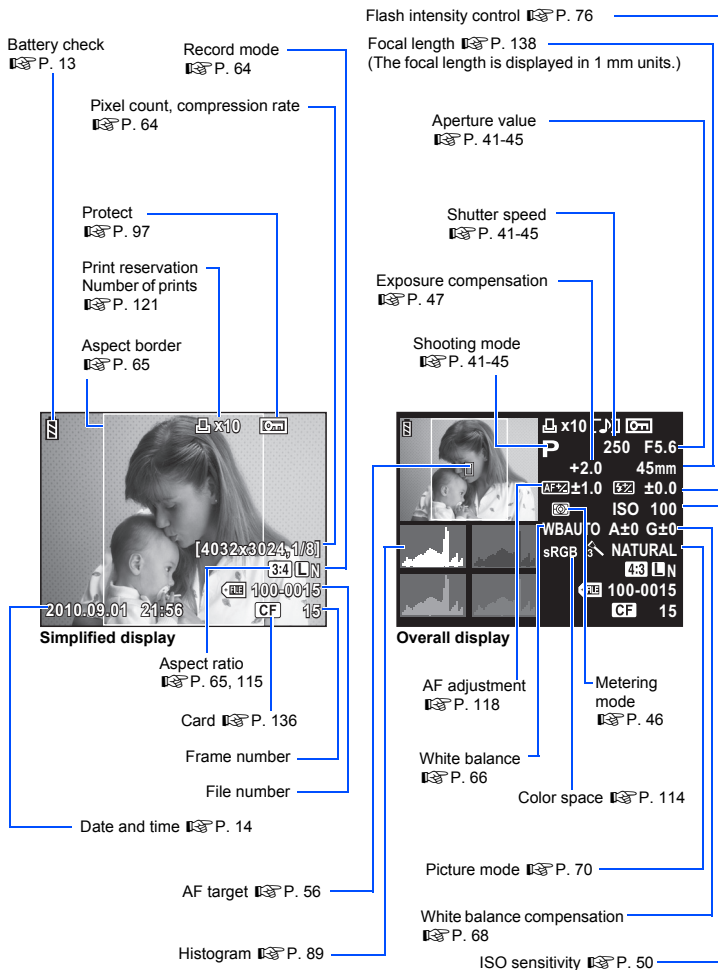

Unpack the box contents

The following items are included with the camera.

If anything is missing or damaged, contact the dealer from whom you purchased the camera.



Camera



Body cap



Strap

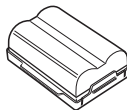

BLM-5 Lithium ion battery



BCM-5 Lithium ion charger

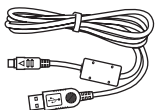

USB cable

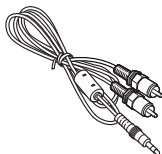

AV cable (Monaural)

- OLYMPUS Setup CD-ROM
- Instruction manual
- Warranty card

Attaching the strap

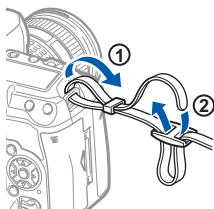

Thread the strap as indicated by the arrows (1, 2).

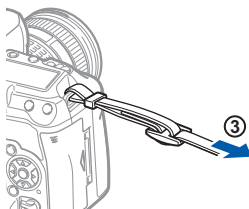

Lastly, pull the strap tight making sure that it is fastened securely (3).

Attach the other end of the strap to the other eyelet in the same way.

Preparing the battery

1 Charging the battery

Remove the protection cap from the battery.

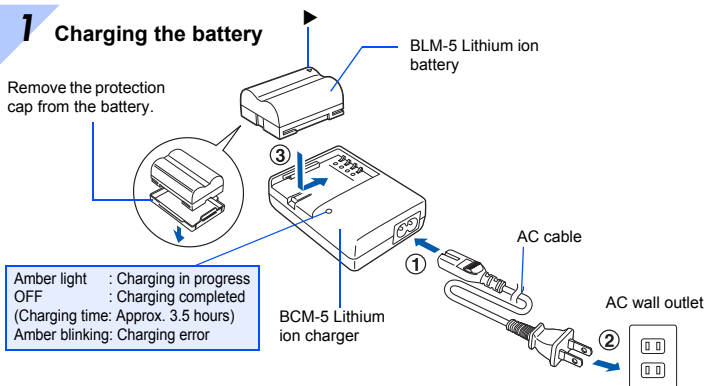

2 Loading the battery

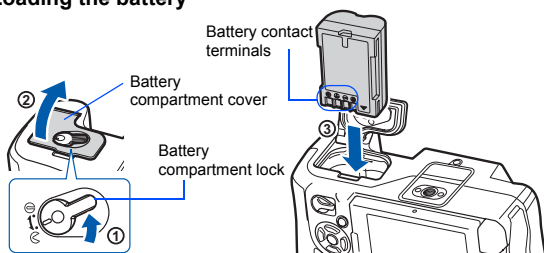

3 Close the battery compartment cover and slide the battery compartment lock in the direction of ☺

Unloading the battery

Press the battery lock to unlock the battery. Turn the camera upside-down to remove the battery.

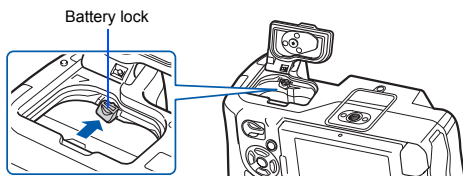

It is recommended to set aside a backup battery for prolonged shooting in case the battery in use drains.

Attaching a lens to the camera

- 1** Remove the body cap from the camera and the rear cap from the lens

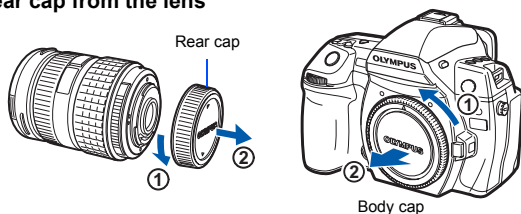

- 2** Attach a lens to the camera

- Align the lens attachment mark (red) on the camera with the alignment mark (red) on the lens, then insert the lens into the camera's body (1).
- Rotate the lens in the direction indicated by the arrow until you hear it click (2).

- Make sure the power switch is set to OFF.
- Do not press the lens release button.

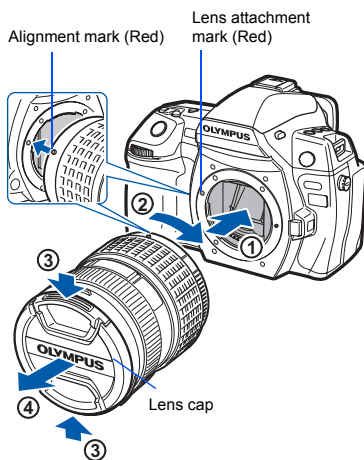

- 3** Remove the lens cap (3, 4)

Removing the lens from the camera

While pressing the lens release button (1), rotate the lens in the direction of the arrow (2).

- Make sure the power switch is set to OFF.

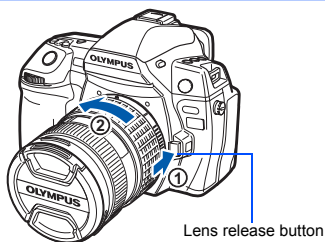

Loading the card

Compact Flash

Open the card cover (①, ②).
Insert the CF card (referred to as "card" in these instructions) into the slot as far as it can go (③).

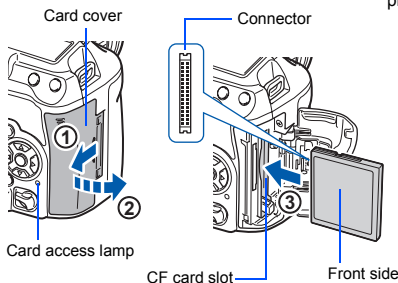

SD Card

Open the card cover (①, ②).
Insert the SD/SDHC/SDXC card (referred to as "card" in these instructions) until it locks in place (③).

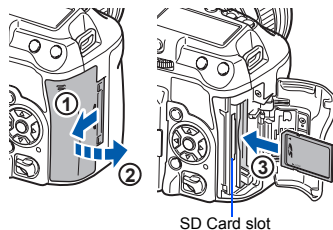

Removing the card

Never open the card cover while the card access lamp is blinking.

Compact Flash

- Press the eject button all the way in to make it pop out.
- Pull out the card.

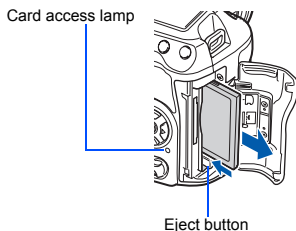

SD Card

- Press the inserted card lightly and it will be ejected.
- Pull out the card.

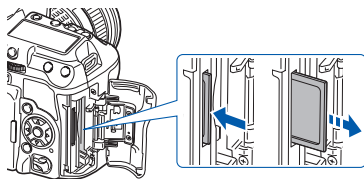

- Turn off the camera before loading or removing the card.
- The power is turned off if you load or remove the card with the power on.

Power on

1 Set the camera's power switch to ON

- To turn off the power, set the power switch to OFF.

LIGHT button

Turns the control panel light on and off.

Control panel

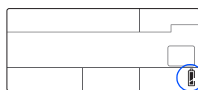

When the camera is turned on, the battery check is displayed on the control panel.

- Lit up (ready for use)
- Lit up (battery power is low)
- Blinks (charging required)

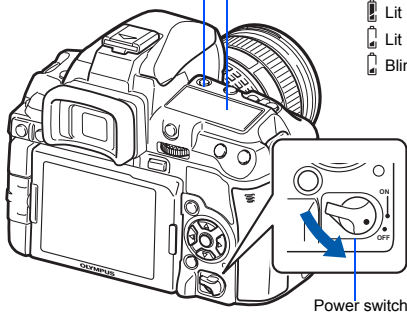

Power switch

Dust reduction function operation

The dust reduction function is automatically activated when the camera is turned on. Ultrasonic vibrations are used to remove dust and dirt from the image pickup device's filter surface.

Adjusting the viewfinder's diopter

Adjust the viewfinder's diopter in accordance with your vision. While looking through the viewfinder, rotate the diopter adjustment dial little by little. When you can see the AF target clearly, adjustment is complete.

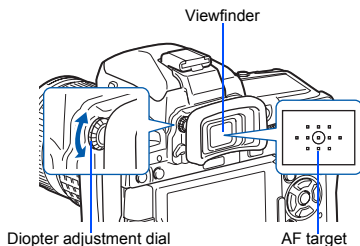

Diopter adjustment dial

AF target

Setting the date/time

Date and time information is recorded on the card together with the images. The file name is also included with the date and time information. Be sure to set the correct date and time before using the camera.

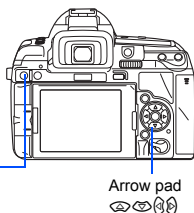

1 Press the **MENU** button

- The menu screen is displayed on the LCD monitor.

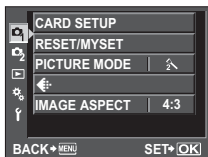

2 Use to select [f], then press

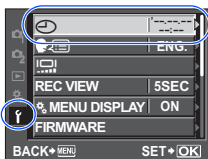

3 Use to select [TIME], then press

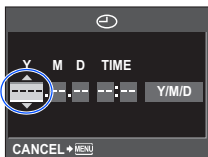

4 Use to select [Y], then press



5 Repeat this procedure until the date and time are completely set

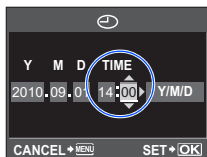

- The time is displayed in the 24-hour format.

6 Use to select the date format



7 Press the **OK** button



8 Press the **MENU** button to exit

- 1 Place the AF target on the subject while viewing through the viewfinder

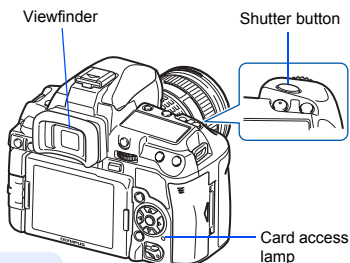

- 2 Adjust the focus

Press the shutter button halfway.

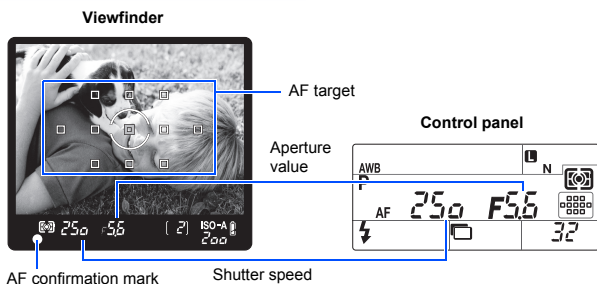

- The focus is locked when a beep tone is output. The AF confirmation mark and the AF target in focus light up in the viewfinder.
- The shutter speed and aperture value that have been set automatically by the camera are displayed.
- The super control panel is not displayed while the shutter button is pressed.

- 3 Release the shutter

Press the shutter button all the way (fully).



- The shutter sounds and the picture is taken.
- The card access lamp blinks and the camera starts recording the picture.

Never remove the battery or card while the card access lamp is blinking. Doing so could destroy stored pictures and prevent storage of pictures you have just taken.

Holding the camera

Keep your fingers and the strap away from the lens, flash, and the white balance sensor.

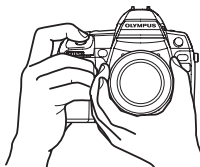

Horizontal grip

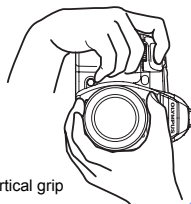

Vertical grip

Taking a picture while viewing the monitor

It is possible to use the LCD monitor as a viewfinder and check the subject's composition, or shoot while viewing an enlarged display on the LCD monitor.

 "Using live view" (P. 35)

1 Press the (live view) button to switch to live view

- The subject is displayed on the LCD monitor.

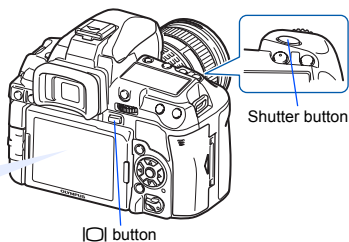

2 Press the shutter button to take the picture

- The picture is taken with the focus adjusted.

Recording a movie

During live view shooting, you can record a movie.

1 Press the (live view) button to switch to live view

- The subject is displayed on the LCD monitor.

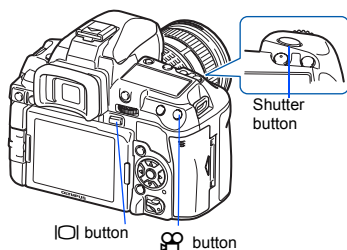



2 Adjust the focus

- Press the shutter button halfway.

3 Press the button to begin recording

- Press the  button again to end recording.
- During recording a movie, press the shutter button to shoot a still picture.

When the camera stops operating

If no operations are performed for approximately 8 seconds while the camera is on, the monitor backlight gets darker to save battery power. (when the super control panel is lit). If no operations are performed for approximately one minute thereafter, the camera enters the sleep mode (stand-by) and stops operating. The camera activates again when you touch any button (the shutter button,  button, etc.).  "BACKLIT LCD (Backlight timer)" (P. 109), "SLEEP" (P. 108)

Playback/Erasing

Playing back images

Pressing the  button displays the last picture taken.

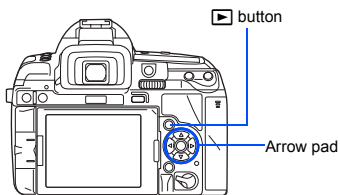

Displays the previous frame



Displays the next frame

Use  to forward the frames.

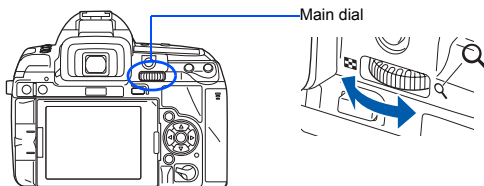

Close-up playback

Each time you turn the main dial towards **Q**, the image is incrementally enlarged from 2× to 14×.



Erasing images

Play back the image you want to erase and press the  button.

Use   to select **[YES]** and press the  button to erase.

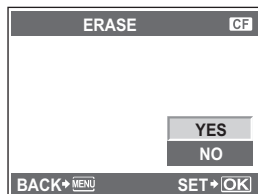
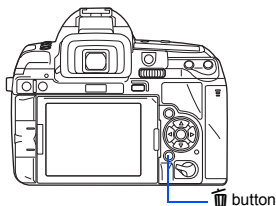

Basic operations

There are three basic ways to operate this camera.

Using the direct buttons to operate the camera P. 20

You can make the function settings with the main dial or sub dial and the direct buttons assigned to a function. Setting information is displayed in the viewfinder and on the control panel and super control panel while you are setting a function. This is useful for operating the camera while composing the subject in the viewfinder and for quickly operating the camera while checking the settings on the control panel.

Setting while looking at the super control panel P. 21

You can make the function settings with the super control panel on the LCD monitor. You can use the super control panel to view the current settings and directly change the settings. During live view, you can make the function settings with the live control ( P. 37) while checking the actual image that will be recorded.

Setting on the menu P. 22

You can use the menu to set shooting and playback settings and customize camera functions.

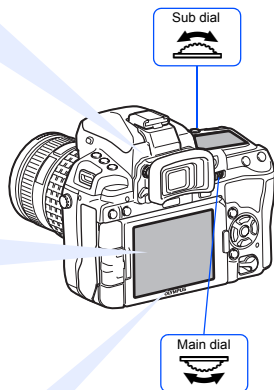

Using the direct buttons to operate the camera

There are two ways to use the direct buttons.

1 While holding down a direct button, turn the main dial or sub dial







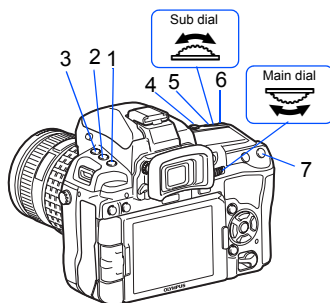



















- Release the button to set the function.

After pressing one or two buttons at the same time, turn the main dial or sub dial

- The function remains selected for approximately 8 seconds. You can turn the dial and set the function during that time. If no operations are performed during that time, the setting for that function is then set.  "BUTTON TIMER" (P. 107)



List of direct buttons

No.	Direct buttons	Dial	Function	Ref. page
1	AF		Sets AF mode	P. 53
			Sets metering mode	P. 46
2	MODE		Shooting mode (P/A/S/M, etc.)	P. 41
	  		Remote control/Self-timer/Sequential shooting	P. 59-60
1+2	AF+MODE		AE bracketing	P. 49
3			Sets flash mode	P. 73
			Flash intensity control	P. 76
4	WB		Sets white balance	P. 66
2+4	MODE + WB		WB bracketing	P. 69
5			Exposure compensation	P. 47
3+5	 + 		Flash intensity control	P. 76
4+5	WB + 		WB compensation	P. 68
6	ISO		Sets ISO sensitivity	P. 50
5+6	 + ISO		RESET/MYSET	P. 101
7			AF target selection	P. 56

Setting while looking at the super control panel

1 Press the **INFO** button to display the super control panel

- Press the **INFO** button again to turn off the super control panel.
- During live view, the live control is displayed.
 - ▶ “Using the live control to operate the camera” (P. 37)
 - ▶ “CONTROL SETTINGS” (P. 109)

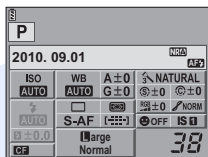
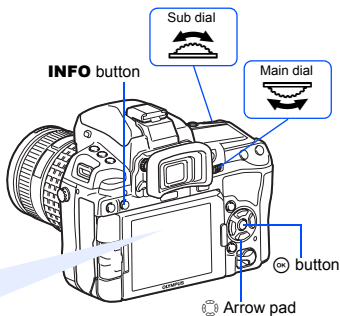

2 Press the **OK** button

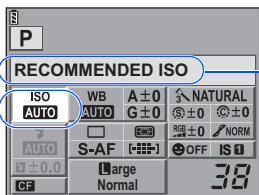

Cursor lights

Displays the selected function name

3 Use **OK** to move the cursor to the function you want to set, and change the setting with the dial

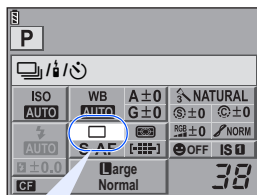

Direct menu

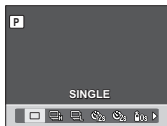

Press the **OK** button to display the direct menu indicated at the position of the cursor. You can also use the direct menu to change the setting. After changing the setting, press the **OK** button to confirm your setting. If no operation is made within a few seconds, your setting is confirmed and the super control panel is displayed.

For details on the functions that can be set with the super control panel, refer to “Super control panel” (P. 6).

Setting on the menu

1 Press the **MENU** button to display the menu

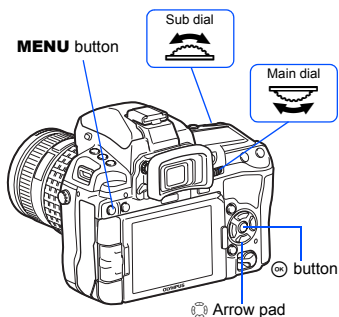
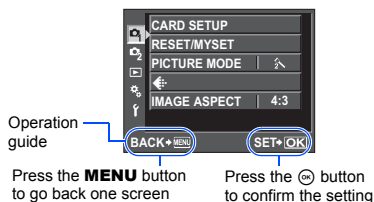

2 Use to select a tab, then press

- Shooting menu 1
- Shooting menu 2
- Playback menu
- Custom menu : Customizes shooting functions. This menu is further divided into 10 tabs, A through J.
- Setup menu : Sets the basic functions of the camera.

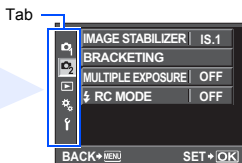

3 Use to select a function and to go to the setting screen

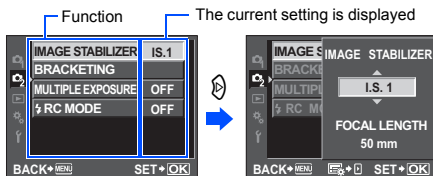

4 Press the **OK** button to confirm the setting

- Press the **MENU** button repeatedly to exit the menu.

Using the dials to select a menu

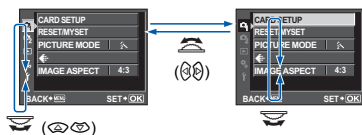

- Selecting a function and rotating the main dial automatically changes the tab and allows you to select a function on the next tab.

For details on the functions that can be set with the menu, refer to "Menu directory" (P. 146).

Table of Contents

Basic guide

2

Identifies the camera part names and describes the basic steps for shooting and playback.

Names of parts and functions	2
Camera	2
Viewfinder	4
Control panel	5
Super control panel	6
LCD monitor (Live view)	7
LCD monitor (Playback)	8
Preparations for shooting	9
Unpack the box contents	9
Preparing the battery	10
Attaching a lens to the camera	11
Loading the card	12
Power on	13
Setting the date/time	14
Shooting	15
Playback/Erasing	18
Basic operations	19
Basic operations	19
Using the direct buttons to operate the camera	20
Setting while looking at the super control panel	21
Setting on the menu	22

1 Using live view

35

Functions and operations available only during live view will be explained.

Activating live view	35
Functions available during live view	35
Taking a picture using live view	36
Using the live control to operate the camera	37
Using the face detection function	38
Taking a picture using manual focus	38
Switching the information display	39
Taking a picture while comparing the effect	40
Enlarged display operation	40

2 Exposure

41

Describes functions related to exposure, which is important for shooting. These functions are for determining the aperture value, shutter speed, and other settings by measuring the brightness in the picture.

Program shooting	41
Aperture priority shooting	42
Shutter priority shooting.....	43
Manual shooting	44
Bulb shooting.....	45
Preview function	46
Changing the metering mode	46
Exposure compensation.....	47
AE lock	48
AE bracketing	49
ISO sensitivity setting	50
ISO bracketing.....	51
Multiple exposure	51

3 Focusing and shooting functions

53

Describes the optimal focusing methods according to the subject and shooting conditions.

AF mode selection.....	53
S-AF (single AF).....	53
C-AF (continuous AF)	54
MF (manual focus)	54
Simultaneous use of S-AF mode and MF mode (S-AF+MF)	55
Simultaneous use of C-AF mode and MF mode (C-AF+MF).....	55
AF target selection.....	56
Registering an AF target mode	58
Sequential shooting	59
Self-timer shooting.....	60
Remote control shooting.....	60
Anti-shock.....	62
Image stabilizer	62

4 Record mode, white balance, and picture mode

64

Describes image adjustment functions specific to digital cameras.

Selecting the record mode.....	64
Recording formats.....	64
Selecting the record mode	65
Setting the image aspect.....	65
Selecting the white balance.....	66
Setting the auto/preset/custom white balance	67
WB compensation	68
Setting the one-touch white balance	69

WB bracketing	69
Picture mode	70
Noise reduction.....	72
Noise filter.....	72

5 Flash shooting

73

Describes how to shoot with the built-in flash and an external flash.

Flash mode setting	73
Built-in flash shooting	76
Flash intensity control	76
Flash bracketing	77
External flash shooting	78
Shooting with the Olympus wireless RC flash system.....	80
Using commercially available flashes.....	82

6 Recording and viewing movies

83

Describes movie recording method and functions.

Recording movies.....	83
Changing the movie record mode	84
Recording sound	84
Viewing movies.....	85

7 Playback functions

86

Describes the functions for image playback.

Single-frame/Close-up playback.....	86
Light box display	87
Index display/Calendar display.....	88
Information display	89
Slideshow	90
Rotating images.....	91
Playback on TV	91
Editing still images.....	93
Image overlay	95
Copying images.....	96
Protecting images.....	97
Erasing images.....	98

8 Setup functions

99

Describes the basic settings for using the camera.

Setup Menu	99
🕒 (Date/time setting).....	99
🗣️ (Changing the display language)	99
📺 (Monitor brightness adjustment).....	99















REC VIEW	99
⚙️ MENU DISPLAY	99
FIRMWARE.....	100
RESET/MYSET	100
Setting MYSET.....	100
Resetting the settings.....	101

9 Customizing your camera

102

Describes how to customize the camera's settings.

📷A AF/MF	102
AF AREA.....	102
[••] SET UP.....	102
RESET LENS.....	102
BULB FOCUSING.....	102
FOCUS RING.....	103
MF ASSIST	103
[••]SET HOME	103
PD AFL.....	103
AF ILLUMINAT. (AF Illuminator)	103
C-AF LOCK	103
AF AREA POINTER.....	103
AF SENSITIVITY.....	103
📷B BUTTON/DIAL	104
DIAL FUNCTION.....	104
DIAL DIRECTION	104
AEL/AFL.....	105
AEL/AFL MEMO.....	106
BUTTON FUNCTION.....	106
BUTTON TIMER	107
📷 ↔ 📷.....	107
📷C RELEASE/📷.....	108
RLS PRIORITY S/RLS PRIORITY C	108
📷 L fps.....	108
📷D DISP/📷)/PC.....	108
HDMI.....	108
VIDEO OUT	108
SLEEP.....	108
LIVE VIEW BOOST.....	109
😊 FACE DETECT	109
📷/INFO SETTINGS	109
📷CONTROL SETTINGS	109
HISTOGRAM SETTINGS	109
BACKLIT LCD (Backlight timer)	109
📷).....	109
VOLUME	109
USB MODE	110
LEVEL GAUGE.....	110

	4 h TIMER (Auto power off).....	111
	PICTURE MODE SETTINGS.....	111
	EXP/  /ISO.....	111
	EV STEP.....	111
	METERING.....	111
	AEL Metering.....	111
	ISO STEP.....	111
	ISO-AUTO SET.....	111
	ISO-AUTO.....	112
	BULB TIMER.....	112
	ANTI-SHOCK [♦].....	112
	⚡ CUSTOM.....	112
	⚡ X-SYNC.....	112
	⚡ SLOW LIMIT.....	112
	 + 	112
	◀-/ASPECT/COLOR/WB.....	113
	NOISE REDUCT. (Noise Reduction).....	113
	NOISE FILTER.....	113
	WB.....	113
	ALL 	113
	COLOR SPACE.....	114
	SHADING COMP.....	114
	◀ SET.....	114
	PIXEL COUNT.....	114
	ASPECT SHOOTING.....	115
	RECORD/ERASE.....	115
	QUICK ERASE.....	115
	RAW+JPEG ERASE.....	115
	FILE NAME.....	116
	EDIT FILENAME.....	116
	PRIORITY SET.....	116
	dpi SETTING.....	116
	 / 	116
	COPYRIGHT SETTINGS.....	117
	MOVIE.....	117
	MOVIE 	117
	 UTILITY.....	117
	PIXEL MAPPING.....	117
	EXPOSURE SHIFT.....	117
	CLEANING MODE.....	117
	EXT. WB DETECT.....	117
	AF FOCUS ADJ.....	118
	AA BATTERY TYPE.....	119
	 WARNING LEVEL.....	120
	LEVEL ADJUST.....	120

10 Printing

121

Describes how to print your pictures.

Print reservation (DPOF)	121
Print reservation	121
Single-frame reservation	121
All-frame reservation	122
Resetting the print reservation data	123
Direct printing (PictBridge).....	123
Connecting the camera to a printer	124
Easy printing	124
Custom printing	125

11 Using the OLYMPUS Viewer 2 / [ib]

127

Describes how to transfer and store your camera images to a computer.

Windows.....	127
Macintosh.....	128
Import and store the image without OLYMPUS Viewer 2 or [ib].....	129

12 Shooting tips and maintenance

130

Refer to this section for troubleshooting and camera maintenance information.

Shooting tips and information	130
Error codes	132
Camera maintenance	134
Cleaning and storing the camera	134
Cleaning mode — Removing dust	135
Pixel mapping — Checking the image processing functions	135

13 Information

136

Refer to this section for information on optional accessories, camera specifications, and other useful shooting information.

Card basics.....	136
Usable cards	136
Formatting the card	136
Battery and charger	137
Using your charger abroad	137
Interchangeable lenses	138
ZUIKO DIGITAL interchangeable lens	138
ZUIKO DIGITAL lens specifications	139
Program line diagram (P mode).....	140
Flash synchronization and shutter speed	141
Exposure warning display.....	141
Flash modes that can be set by shooting mode	142
White balance color temperature.....	143

Record mode and file size/number of storable still pictures	144
Functions that can be registered with MYSET setting	145
Menu directory	146
Specifications	153
SAFETY PRECAUTIONS	156
Index	163

Quick reference

Shooting		
Correct focus cannot be obtained	Select the AF target and take the picture.	P. 56
	The minimum shooting distance varies depending on the lens. Move to the minimum shooting distance of the lens from the subject and take a picture.	P. 138
	The camera may be having difficulty focusing on the subject with auto focus. Use MF to fix the distance of the focus.	P. 54, P. 131
	It may be easier to focus, even in low light situations, when using the AF illuminator.	P. 103
Focusing on one area	Select the AF target and take the picture using the desired AF target.	P. 56
	Use MF. It may be helpful to focus while using live view with an enlarged image.	P. 38, P. 40, P. 54
	Set [AF SENSITIVITY] to [SMALL] and focus using a smaller area.	P. 103
Taking pictures of nearby subjects	Use macro lens for close-up shots.	P. 138
Taking pictures while checking the results	During live view, you can take a picture while checking the white balance, exposure compensation, picture mode, and other settings on the LCD monitor.	P. 35
	You can take a picture while using the live multi view display to compare the effect of white balance or exposure compensation.	P. 40
	You can use the preview function to check the depth of field at a selected aperture value.	P. 46
	You can use live view to check the set exposure conditions.	P. 109
	You can use [TEST PICTURE] to check the image on the LCD monitor without recording the image to a card.	P. 106
Extending the useful life of the battery	Pressing the shutter button halfway, playing back images, and using the live view function over a long period consumes considerable battery power. Limiting these actions will help extend the useful life of the battery.	—
	Set [SLEEP] so that the camera enters sleep mode faster.	P. 108
	Set [BACKLIT LCD] so that the backlight turns off faster.	P. 109
Increasing the number of pictures that can be taken	Reduce the pixel count and compression rate settings.	P. 64, P. 114
	You can insert two types of cards.	P. 12, P. 136



Taking pictures in low light situations without using the flash	Increase the ISO sensitivity.	P. 50
	Set the image stabilizer function.	P. 62
Setting the camera to fire the flash automatically in low light situations	Set the flash setting to [AUTO] .	P. 73
Taking pictures without whites appearing too white or blacks appearing too dark	Take a picture while checking the histogram and Highlight&Shadow.	P. 39
	Take a picture while checking the shutter speed and aperture value displays. If either is blinking, the optimal exposure is not obtained.	P. 41-43, P. 141
	Set the gradation setting to [AUTO] . Subjects with areas of large contrast are adjusted automatically.	P. 71
	Adjust the exposure compensation.	P. 47
Taking monotone pictures	Set [PICTURE MODE] to [MONOTONE] . You can take monotone pictures in black and white, sepia tones, purplish tones, bluish tones, and greenish tones. Or set [PICTURE MODE] to [GRAINY FILM] .	P. 70
	Recorded images can be edited into black-and-white or sepia-toned images.	P. 93
Taking pictures of a subject against backlight	Set the gradation setting to [AUTO] .	P. 71
	Set the flash setting to [ (fill-in flash) and take the picture.	P. 73
	Use spot metering to measure the exposure of the subject in the center of the picture. If the subject is not in the center of the picture, use AE lock to lock the exposure, and then change the composition and take the picture.	P. 46, P. 48
Brightening a dark backlit image	You can adjust the image using [SHADOW ADJ] of [JPEG EDIT] .	P. 93
Taking pictures with a blurred background	Use A (aperture priority) mode to decrease the aperture value as much as possible. You can blur the background more by shooting up close to the subject.	P. 42
Taking pictures that stop the subject in motion or convey a sense of motion	Use the S (shutter priority) mode to take the picture.	P. 43
Taking pictures with the correct color	Set the white balance according to the light source. You can also make fine changes to the settings.	P. 66
	With WB bracket shooting, you can capture 3 to 9 images with different white balance settings for each picture taken. This enables you to take pictures with the desired white balance without having to make fine changes to the settings.	P. 69

Taking pictures so that whites come out white and blacks come out black	Set the spot metering for highlight or shadow control. If the subject is not in the center of the picture, use AE lock to lock the exposure, and then change the composition and take the picture.	P. 46, P. 48
	Adjust the exposure compensation. It may be helpful to use AE bracketing if you are not sure about the exposure compensation value.	P. 47, P. 49
	Set the gradation setting to [HIGH KEY] or [LOW KEY] and take a picture.	P. 71
Taking pictures without noise	Set the ISO sensitivity to a low value, ISO 200 is recommended.	P. 50
	Set [NOISE REDUCT.] to [AUTO] or [ON] .	P. 72
	When the ISO sensitivity is set to 3200 or another high value, set [NOISE FILTER] to [HIGH] .	P. 72
Making the viewfinder easier to view	Adjust the viewfinder's diopter in accordance with your vision.	P. 13
	If the viewfinder is still difficult to view after adjusting the diopter or you want to use the viewfinder without eyeglasses, you can replace the viewfinder with the optional diopter compensation eyecup.	—
Optimizing the LCD monitor	You can adjust the brightness of the LCD monitor.	P. 99
	During live view, set [LIVE VIEW BOOST] to [ON] to make the subject easier to see without the exposure reflecting on the LCD monitor.	P. 109
Reducing camera shake	Set the image stabilizer function.	P. 62
	Hold the camera firmly when pressing the shutter button. When using a slow shutter speed, be sure to stabilize the camera by using a tripod or similar method.	P. 16
	Fire the flash regardless of the light conditions.	P. 73
	Increase the ISO sensitivity. When ISO is set to [AUTO] , set the upper limit to a high value, such as 1600, so that ISO automatically increases in low light situations.	P. 50, P. 111
	Using the self-timer can reduce camera shake that occurs when the shutter button is pressed.	P. 60
Taking pictures while checking the level of the camera	You can display the level gauge to check whether the camera is level.	P. 110
	Display the ruled lines in live view. Compose the shot so that the subject and ruled lines are horizontally and vertically aligned.	P. 39, P. 110
Taking a picture using the art filter	Set [PICTURE MODE] to ART1 to ART6 .	P. 70
Recording a movie	Activate the live view and press the  button.	P. 83

Playback		
Displaying the image after the picture is taken	Set [REC VIEW] . You can set the number of seconds that the image is displayed.	P. 99
Displaying the image after the picture is taken and deleting unneeded images	Set [REC VIEW] to [AUTO ▶] . After you take a picture, the camera switches to playback mode automatically, allowing you to delete the image.	P. 99
Checking to see whether the photographed subject is in focus.	Use close-up playback to check whether the subject is in focus.	P. 86
Quickly searching for the desired image	Use index display to search from a index of between 4 and 100 frames.	P. 88
	Use calendar display to search by the date the picture was taken.	P. 88
Viewing images on a TV	Use the AV cable or the HDMI cable to play back recorded images on your TV. You can also view the images as a slideshow.	P. 91, P. 92
Comparing images	You can use light box display to display two frames side by side.	P. 87
	You can play back another image without changing the magnification.	P. 86

Settings		
Saving the settings	You can register up to four camera settings which are frequently used as MYSET. By registering the setting, you can select it as one of the shooting mode such as P, S, A, M. Also, assign MYSET 1 to 4 to the specified button (Fn / [▶] / [◀] (Preview)) in [BUTTON FUNCTION] so that you can easily use that function during shooting.	P. 100
Changing the menu display language	You can change the display language.	P. 99

Indications used in this manual

- The operation button icons on the body of the camera are used to indicate the operation buttons in this manual. See “Names of parts and functions” (P. 2).
- In this manual,  indicates the main dial on the back of the camera.
- In this manual,  indicates the sub dial on the front of the camera.
- The operating instructions of the direct buttons, super control panel and menu are described as follows in this manual.
- “+” indicates operations performed at the same time.
- “▶” indicates you should proceed to the next step.

e.g.: When setting the white balance

Direct button

WB +  / 



Super control panel

 ▶  : [WB]

Menu

MENU ▶ [] ▶ [] ▶ [WB]

- The following symbols are used throughout this manual.

 Notes	Important information on factors which may lead to a malfunction or operational problems. Also warns of operations that should be absolutely avoided.
 TIPS	Useful information and hints that will help you get the most out of your camera.
	Reference pages describing details or related information.

1 Using live view

Activating live view



It is possible to use the LCD monitor as a viewfinder. You can view the exposure or white balance effect and the subject's composition while you take the picture. Close the eyepiece shutter so the light entering through the viewfinder does not affect the exposure while shooting with live view.

1 Press the button.

- The mirror is raised and the subject is displayed on the LCD monitor.
- When [AF MODE] was set to [C-AF], it will be set automatically to [S-AF] (or [S-AF+MF] in case it was set to [C-AF+MF]).

Eyepiece shutter

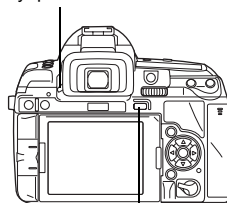

 button





1

Using live view



Functions available during live view

The following functions can be used during live view.



Focusing during live view

- Taking a picture while adjusting the focus manually  P. 38
- Taking a picture while focusing on a face  P. 38
- Taking a picture while checking the focus by enlarging the zone to be focused  P. 40
- Taking a picture using phase difference AF  P. 103, P. 105

Taking a picture while checking the effect

- Taking a picture after comparing the effect of exposure compensation or white balance  P. 40
- Taking a picture while checking the effect of image stabilizer ( P. 62)

Switching the information on the LCD monitor

- Turning on/off the information display. Displaying the histogram or ruled lines  P. 39
- Checking the subject on the monitor even in low light situations  P. 109

Notes

- If there is a high-intensity light source within the screen, the image may be displayed darker but will be recorded normally.
- If the live view function is used over a long period, the temperature of the image pickup device will rise causing the images with high ISO sensitivity to appear noisy and unevenly colored. Turn off the camera for a period of time allowing it to cool.
- Exchanging the lens will cause live view to stop.

Taking a picture using live view

1

Using live view

1 Press the shutter button halfway.

- When the focus is locked, the AF confirmation mark and AF target mark light up.
- When using a lens other than a high-speed Imager AF compatible lens, the  focus confirmation may not light up. It may be difficult to autofocus.

2 Press the shutter button all the way to take a picture.

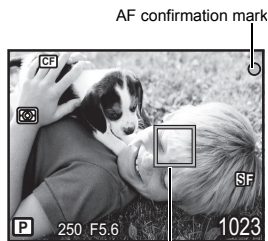

AF target mark

Shooting while changing the angle of the LCD monitor

You can change the angle of the LCD monitor on the camera. This enables you to shoot at an awkward angle while checking the subject's composition on the LCD monitor.

- Slowly rotate the LCD monitor within the moveable range.

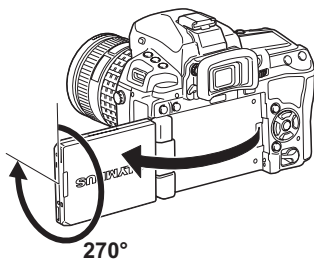

Using the live control to operate the camera

The following screen which simultaneously displays shooting setting functions and associated options is called the live control. You can display and use it by pressing **Fn** button during live view. You can set the art filter, the white balance and other effects while checking live view. When the super control panel is displayed, press the **INFO** button to switch the display.

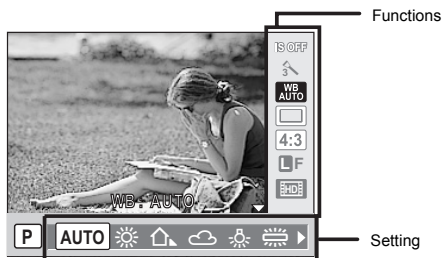

• Available functions

Image stabilizer	P. 62	Flash mode	P. 73
Picture mode	P. 70	Flash intensity control	P. 76
White balance	P. 66	Metering mode	P. 46
.....	P. 59-60	ISO sensitivity	P. 50
Aspect ratio	P. 65	Face detection	P. 38
Record mode	P. 64	Movie sound record	P. 84

1 Press the **Fn** button to display the live control

- Press the **Fn** button again to turn off the live control.

2 Move the cursor to the function you wish to set using the main dial and select settings using the sub dial, then press the **Fn** button

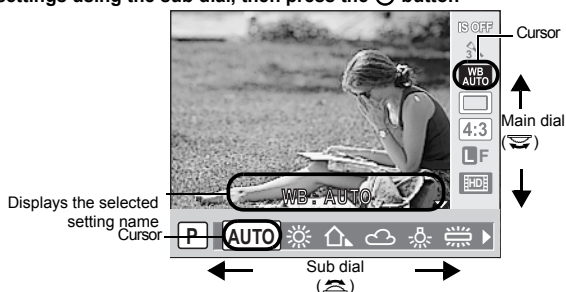

- If no operations are performed during that time, the setting for that function is confirmed.
- You can use the arrow pad instead of the dials.
- There may be unavailable menus depending on the selected shooting mode.
- You can also display the super control panel.

"CONTROL SETTINGS" (P. 109)

Using the face detection function

By setting [**FACE DETECT**] to [**ON**], the camera will detect people's faces in the frame and adjust the focus and metering automatically.

Set the AF target to [] and the metering mode to []. Assign [**Fn FACE DETECT**] to the **Fn** button to easily set to the best settings for taking pictures of people.

Direct button

Fn / (preview) button

(The setting changes each time the button is pressed.)

Super control panel

☉ ▶ () ▶ [**FACE DETECT**]

Menu

MENU ▶ [] ▶ [] ▶ [**FACE DETECT**] ▶ [**ON**]

- In order to use the **Fn** button or (preview) button, [**Fn FACE DETECT**] needs to be set up in the menu in advance. ☞ "BUTTON FUNCTION" (P. 106)
- After setting [**FACE DETECT**] to [**ON**] while using the **Fn** button or (preview) button, the following functions are automatically set to the best settings for taking pictures of people.

Function	Setting	Ref. page
METERING	[]	P. 46
GRADATION	AUTO	P. 71
AF MODE	S-AF	P. 53
AF AREA	[]	P. 56

1 If the camera detects a face, a frame will be displayed in that location.

- When you press the shutter button, the camera will focus on the position of the face detection frame (however, if a single AF target is selected with [**AF AREA**], the camera will focus on the AF target selected).

! Notes

- During sequential shooting, face detection will work only at the first shot.
- Depending on the subject, the camera may not be able to correctly detect the face.
- This function is available only during live view.
- When using phase difference AF, the camera focuses with the AF target which is the closest to the displayed frame.

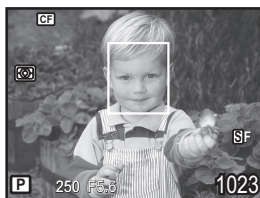

Taking a picture using manual focus

During live view, you can take a picture focusing manually while checking the focus on the LCD monitor.

1 Set the AF mode to [S-AF+MF] or [MF]. ☞ "AF mode selection" (P. 53)

2 Adjust the focus by rotating the focus ring.

- In [**S-AF+MF**] mode, after pressing the shutter button halfway or pressing the **AEL/AFL** button, you can rotate the focus ring to finely adjust the focus before taking the picture.
- Using the enlarged display can be very convenient when adjusting the focus manually. ☞ "Enlarged display operation" (P. 40)

Switching the information display

You can switch the information displayed on the monitor by pressing **INFO** button repeatedly. You can also switch the information displayed by turning the dial while pressing the **INFO** button.

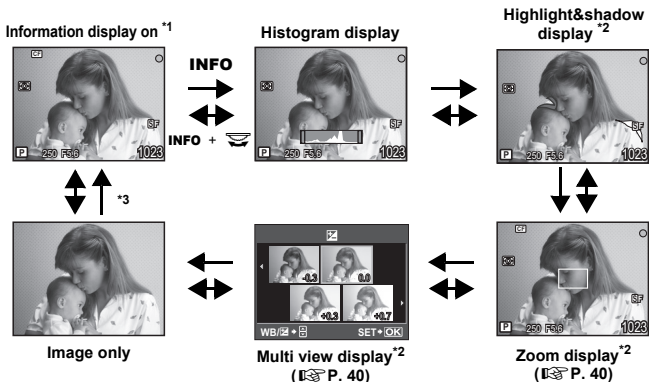

*1 With **[INFO/SETTING]** (P. 109), you can also select **[GRID]/[LAYOUT]/[INFO]** for the ruled line display.

*2 It is displayed when **[INFO/SETTINGS]** (P. 109) is **[ON]**.

Some items are not displayed depending on the settings.

*3 During multiple exposure shooting (P. 51) or when **[LEVEL GAUGE]** (P. 110) is set to **[ON]**, the information display switches to "Multiple exposure display" and "Digital level gauge display".

TIPS

To quickly switch to the frequently used display:

→ You can hide the information display for all modes except "Information display on". **[INFO/SETTINGS]** (P. 109)

How to read the histogram:

→ The following shows you how to read the histogram display easily.

- 1 If the graph has many peaks around here, the image will appear mostly black.
- 2 If the graph has many peaks around here, the image will appear mostly white.
- 3 The part indicated in green in the histogram shows the luminance distribution within the spot metering area.

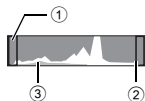

Taking a picture while comparing the effect

You can check the effect of exposure compensation or white balance on a 4-split screen.

1

Using Live View

1 Press the INFO button repeatedly to display the multi view display.

☞ "Switching the information display" (P. 39)

- The exposure compensation comparison screen is displayed. Press \odot to switch to the white balance comparison screen. Press \odot to switch the screen.

2 Use \odot or the dial to select the setting value, then press the \odot button.

- You can take the picture using the set value.



! Notes

- Exposure compensation is not available in **M** or **BULB** modes.
- This function cannot be used when the picture mode is set to an art filter.
- When the exposure compensation value exceeds ± 3 , the effect is not displayed correctly.

Enlarged display operation

It is possible to enlarge the subject for display. Enlarging the image during MF makes focus confirmation and adjustment easier.

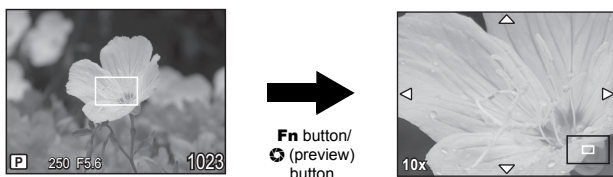

1 Press the Fn button/ \odot (preview) button to display the zoom display.

- The enlargement frame will be displayed.
- In this state, press the shutter button halfway, and focus using the enlargement frame regardless of the AF target setting. (Zoom frame AF)

2 Use \odot to move the frame and press the Fn button/ \odot (preview) button.

- The area inside the frame is enlarged and displayed.
- In this state, press the shutter button halfway to focus while zoomed.
- Press and hold the \odot button to return the enlargement frame to the center after it was moved.

3 Turn the dial to change the magnification (5x/7x/10x/14x).

- Use \odot to scroll the frame even during magnification.
- Press the \odot button, or press and hold the Fn button/ \odot (preview) button to cancel the zoom display.

TIPS

To enlarge the image just by rotating the focus ring:

☞ "MF ASSIST" (P. 103)

To enlarge the image when the Fn button/ \odot (preview) button is set to other function:

→ Press the INFO button to display the zoom display, and then press the \odot button.

☞ "Switching the information display" (P. 39)

Program shooting

P

The camera sets the optimum aperture value and shutter speed automatically according to the subject brightness.

While holding down the **MODE** button, turn the main dial to set the shooting mode to **P**.

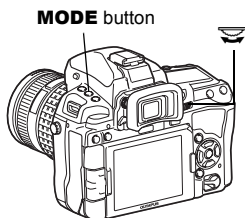

- When the shutter button is half-pressed, the shutter speed and aperture value are displayed on the viewfinder and control panel.

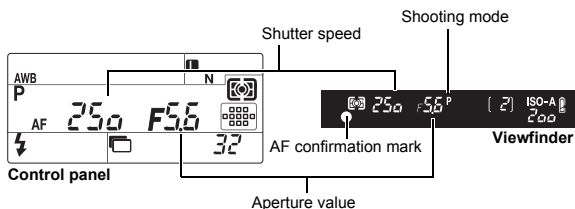

Program shift (Ps)

By turning the main dial (or sub dial) in the **P** mode, you can change the combination of aperture and shutter speed while maintaining the optimum exposure.

☞ “Program line diagram (**P** mode)” (P. 140)

- The program shift setting will not be canceled after shooting. To cancel program shift setting, turn the main dial (or sub dial) until **Ps** disappears from the viewfinder or control panel, or turn off the power.
- Program shift is not available when you are using a flash.

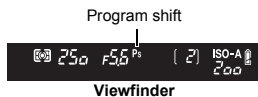

TIPS

The shutter speed and aperture value are blinking:

→ The optimum exposure cannot be obtained. For details, see “Exposure warning display” (☞ P. 141).

Aperture priority shooting

A

The camera sets the optimum shutter speed automatically for the aperture value you have selected. When you open the aperture (decrease the aperture value), the camera will focus within a shorter range (shallow depth of field) and produce a picture with a blurred background. When you close the aperture (increase the aperture value), the camera will focus within a longer range. Use this mode when you wish to add detail to the background.

2
Exposure

When the aperture value (f-number) is decreased



When the aperture value (f-number) is increased

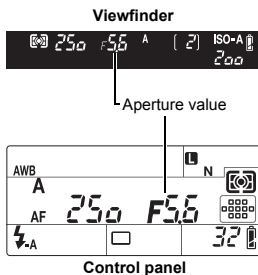
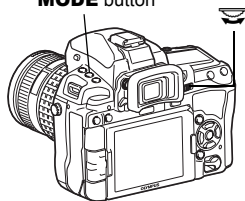

While holding down the **MODE** button, turn the main dial to set the shooting mode to **A**. Turn the main dial (or sub dial) to set the aperture value.

**MODE** button

Open the aperture (f-number is decreased)

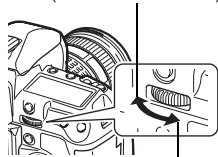

Close the aperture (f-number is increased)

TIPS

To check the depth of field with the selected aperture value:

→ See "Preview function" (P. 46).

To change the exposure adjustment interval:

→ This can be set in 1/3 EV, 1/2 EV or 1 EV increments. (P. 111)

Shutter speed is blinking:

→ The optimum exposure cannot be obtained. For details, see "Exposure warning display" (P. 141).

Shutter priority shooting

S

The camera sets the optimum aperture value automatically for the shutter speed you have selected. Set the shutter speed depending on the type of effect you want. A higher shutter speed allows you to capture a fast-moving subject without blur, and a slower shutter speed blurs a moving subject, creating a feeling of speed or motion. Set the shutter speed depending on the type of effect you want.

A fast shutter speed can freeze a fast action scene without any blur.



A slow shutter speed will blur a fast action scene. This blurring will give the impression of dynamic motion.

While holding down the **MODE** button, turn the main dial to set the shooting mode to **S**. Turn the main dial (or sub dial) to set the shutter speed.

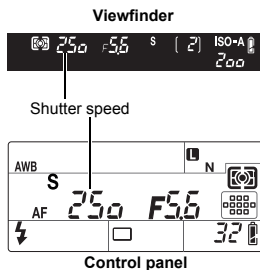
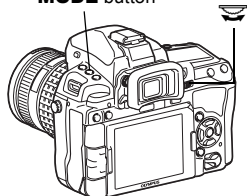
**MODE** button

Slower shutter speed

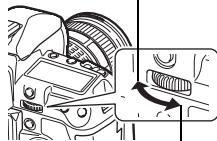

Faster shutter speed

TIPS

The picture looks blurred:

- The possibility of camera shake spoiling your picture increases greatly during macro or ultra-telephoto shooting. Raise the shutter speed or use a monopod or tripod to stabilize the camera.
- When the shutter speed is slow, camera shake is more likely to occur. You can reduce camera shake by using the image stabilizer. "Image stabilizer" (P. 62)

To change the exposure adjustment interval:

- This can be set in 1/3 EV, 1/2 EV or 1 EV increments. "EV STEP" (P. 111)

The aperture value is blinking:

- The optimum exposure cannot be obtained. For details, see "Exposure warning display" (P. 141).

2

Exposure

Allows you to set the aperture and shutter speed manually. You can check how much it differs from the appropriate exposure by using the exposure level indicator. This mode gives you more creative control, allowing you to make whatever settings you like, regardless of the correct exposure.

2

Exposure

While holding down the **MODE** button, turn the main dial to set the shooting mode to **M**. Turn the dials to set the aperture value and the shutter speed.

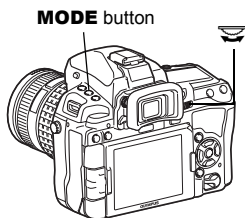

Aperture value: Turn the main dial to set the value.

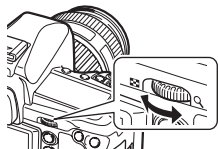

Shutter speed: Turn the sub dial to set the value.

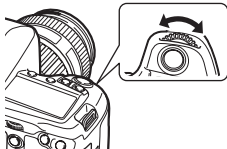

- The range of aperture values available varies with the lens type.
- The shutter speed can be set from 1/8000 to 60 seconds.
- In **M** mode the exposure level indicator will appear on the super control panel screen. It shows the difference (ranging from -3 EV to +3 EV) between the exposure value calculated by the currently selected aperture and shutter speed and the exposure value considered optimum by the camera. If the difference exceeds ± 3 EV, the entire indicator blinks.



Noise in images

During shooting at slow shutter speeds, noise may appear on-screen. These phenomena are caused when current is generated in those sections of the image pickup device that are not normally exposed to light, resulting in a rise in temperature in the image pickup device or image pickup device drive circuit. This can also occur when shooting with a high ISO setting in a high-temperature environment. To reduce this noise, the camera activates the noise reduction function.

☞ "Noise reduction" (P. 72)

TIPS**The picture looks blurred:**

- The use of a monopod or tripod is recommended when taking a picture at slow shutter speed.
- When the shutter speed is slow, camera shake is more likely to occur. You can reduce camera shake by using the image stabilizer.  "Image stabilizer" (P. 62)

To change the exposure adjustment interval:

- This can be set in 1/3 EV, 1/2 EV or 1 EV increments.  "EV STEP" (P. 111)

To switch the operations of the main dial and sub dial:

- You can switch the functions that are set with the main dial and sub dial.  "DIAL FUNCTION" (P. 104)

**Notes**

- Exposure compensation is not available in **M** mode.

Bulb shooting**B**

You can take a picture with a bulb exposure time in which the shutter stays open as long as you hold down the shutter button.

Bulb shooting can also be done using an optional remote control (RM-1) or remote control cable (RM-CB1).  "Bulb shooting with the remote control" (P. 61)

While holding down the MODE button, turn the dial to set the shooting mode to [BULB].

- "buLb" is displayed in the viewfinder and on the control panel.

buLb

TIPS**To automatically end bulb shooting after a specified period of time:**

- You can set the maximum time for bulb shooting.  "BULB TIMER" (P. 112)

To fix the focus during manual focus shooting:

- You can fix the focus so the focus does not change even if the focus ring is turned during exposure.  "BULB FOCUSING" (P. 102)

**Notes**

- The following functions are not available during bulb shooting.
Sequential shooting/self-timer shooting/AE bracket shooting/image stabilizer/flash bracketing/exposure compensation

Preview function

The viewfinder shows the focused area (depth of field) with the selected aperture value.

Press the  (Preview) button to use the preview function.

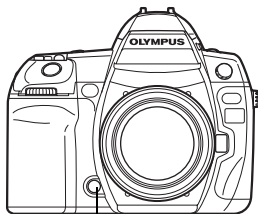

 (Preview) button

Changing the metering mode



There are 5 ways to measure the subject brightness: Digital ESP metering, Center weighted averaging metering, and 3 types of spot metering. Select the most suitable mode for the shooting conditions.

Direct button



Super control panel



Menu

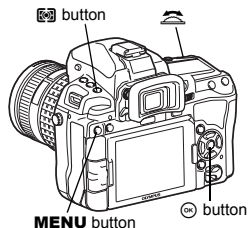

MENU button

 button





Setting display

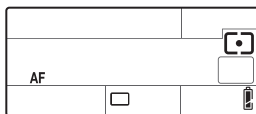

Viewfinder



Control panel

-  : Digital ESP metering
-  : Center weighted averaging metering
-  : Spot metering
-  : Spot metering - highlight control
-  : Spot metering - shadow control

Digital ESP metering

During live view, the camera measures the light levels and calculates the light level differences in 324 separate areas of the image (49 areas when shooting with the view finder). This mode is recommended for general use.

Setting the AF synchronized function to **[ESP+AF]** enables metering centered around the AF target that is in focus with AF. It is available when shooting using the view finder (phase difference AF).

Center weighted averaging metering

This metering mode provides the average metering between the subject and the background lighting, placing more weight on the subject at the center. Use this mode when you do not want the light level of the background to affect the exposure value.

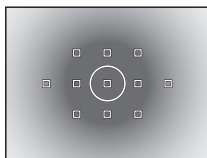

Spot metering

The camera meters a very small area around the center of the subject, defined by the spot metering area mark in the viewfinder. Use this mode when there is very strong backlight.

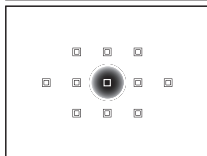

Spot metering - highlight control

When the overall background is bright, white areas of the image will come out gray if you use the camera's automatic exposure. Using this mode enables the camera to shift to over-exposure, allowing accurate white reproduction.

Metering area is the same as spot metering.

 : Metering area

Spot metering - shadow control

When the overall background is dark, black areas of the image will come out gray if you use the camera's automatic exposure. Using this mode enables the camera to shift to under-exposure, allowing accurate black reproduction. Metering area is the same as spot metering.

Exposure compensation



In some situations, you may get better results if you manually compensate (adjust) the exposure value set automatically by the camera. In many cases, bright subjects (such as snow) will turn out darker than their natural colors. Adjusting toward + makes these subjects closer to their real shades. For the same reason, adjust toward - when shooting dark subjects. The exposure can be adjusted in a range of ± 5.0 EV.

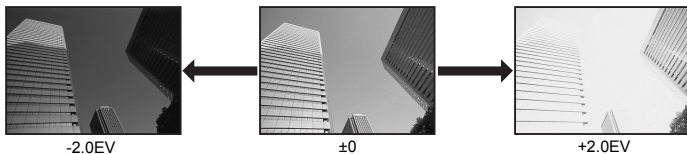

Direct button

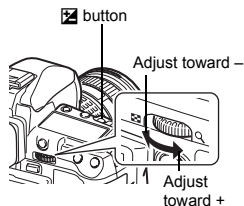

- The exposure compensation indicator is displayed. The exposure compensation indicator will not be displayed when the exposure is compensated by 0.

When set to 1/3 EV increments



When set to 1/2 EV increments

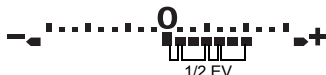

- If the exposure compensation value exceeds the scale of the exposure compensation indicator, the indicator will blink in the viewfinder and on the control panel. A red ◀▶ is displayed on the left and right edges of the indicator on the super control panel.



TIPS

To change the exposure adjustment interval:

→ This can be set in 1/3 EV, 1/2 EV or 1 EV increments. "EV STEP" (P. 111)

To adjust the exposure using only the dials:

→ You can set the exposure compensation value without pressing button.

"DIAL FUNCTION" (P. 104)

! Notes

- Exposure compensation is not available in **M** and **BULB** modes.
- When the exposure compensation value exceeds ± 3 , the effect is not displayed correctly on the live view.

AE lock

AEL

The metered exposure value can be locked with the **AEL/AFL** button (AE lock). Use AE lock when you want a different exposure setting from the one that would normally apply under the current shooting conditions.

Normally, pressing the shutter button halfway locks both AF (auto focus) and AE (automatic exposure), but you can lock the exposure alone by pressing the **AEL/AFL** button.

Press the **AEL/AFL button at the position where you wish to lock the metering values and the exposure will be locked.**

- Pressing the **AEL/AFL** button again cancels the AE lock.



AE lock

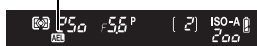

Viewfinder

TIPS

To lock the exposure only while pressing the **AEL/AFL** button:

☞ "AEL/AFL MEMO" (P. 106)

If you find it difficult to press the **AEL/AFL** button and shutter button at the same time:

→ You can switch the functions of the **AEL/AFL** button and the **Fn** button.

☞ "AE ⇌ Fn" (P. 107)

To activate **AE lock** with a set metering mode:

→ You can set the metering mode for locking the exposure with the AE lock.

☞ "AEL Metering" (P. 111)

AE bracketing

The camera automatically shoots a number of pictures at different exposure values for each frame. Even in conditions where correct exposure is difficult to obtain (such as a backlit subject or a scene at dusk), you can pick the picture you prefer from a selected number of frames with a variety of different exposure settings (exposure and compensation values). The pictures are taken in the following order: Picture with optimum exposure, picture adjusted in - direction, and picture adjusted in + direction.

e.g.) When BKT is set to **[3F 1.0EV]**



-1.0EV



±0



+1.0EV

Compensation value: **0.3, 0.5, 0.7 or 1.0**

Number of frames: **2, 3, 5, or 7**

- The available compensation value differs depending on the number of frames.
 - The compensation value and the number of frames will change if the EV step is changed.
- ☞ "EV STEP" (P. 111)

Direct button

MODE + AF ▶ 

Menu

MENU ▶  ▶ **[BRACKETING]** ▶ **[AE BKT]**

Setting display

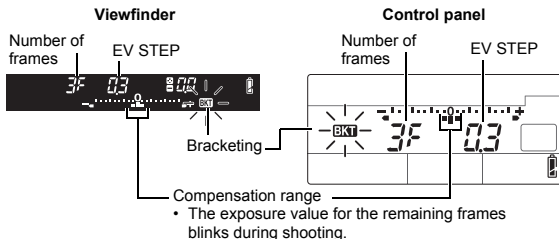

Start shooting.

- In single-frame shooting, the exposure changes every time the shutter button is pressed.
- In sequential shooting, hold down the shutter button until the selected number of frames are taken.
- Releasing the shutter button stops flash bracketing shooting. When it stops, **BKT** blinks in the viewfinder and on the control panel and **BKT** is displayed in green on the super control panel.

How AE bracketing compensates exposure in each shooting mode

Depending on the selected shooting mode, exposure is compensated in the following way:

P mode : Aperture value and shutter speed

A mode : Shutter speed

S mode : Aperture value

M mode : Shutter speed

TIPS

To apply AE bracketing to the exposure value you have compensated:

→ Compensate the exposure value, then use the AE bracketing feature. AE bracketing is applied to the exposure value you have compensated.

ISO sensitivity setting

ISO

The higher the ISO value, the greater the camera's light sensitivity and the better its ability to shoot in low light conditions. However, higher values may give pictures a grainy appearance.

Direct button

ISO ▶

Super control panel

▶ : [ISO]

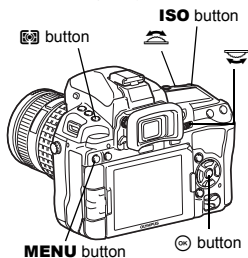

- [AUTO]** : The sensitivity is set automatically according to the shooting conditions. For **[ISO-AUTO SET]**, you can set the default (value normally used when the optimal exposure can be obtained) and upper limit (upper limit of ISO that automatically changes). "ISO-AUTO SET" (P. 111)
- [100 - 6400]** : Fixed ISO sensitivity. **[ISO STEP]** can be changed to **[1/3EV]** or **[1EV]**. "ISO STEP" (P. 111)

Setting display

Viewfinder



When set to **[AUTO]**, the default value is displayed.

Control panel

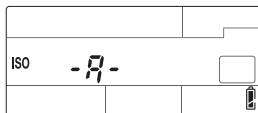

AUTO : **ISO-A**

100 : 100

6400 : 6400

-A-

100

6400

- 125 and 1250 are displayed in the viewfinder as 120 and 1200, respectively.

Display after setting

Viewfinder



When set to **[AUTO]**, ISO-A and the ISO value determined by the camera are displayed. For all other settings, ISO and the set value are displayed. When set to 3200 or a higher value, ISO blinks.

Control panel

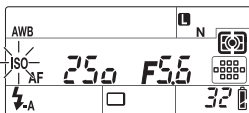

When set to a setting other than **AUTO**, ISO is displayed. When set to 3200 or a higher value, ISO blinks.

TIPS

To automatically set the optimal ISO in **M** mode:

→ Normally, the **AUTO** setting is not available in **M** mode, but you can set it for use in all shooting modes. "ISO-AUTO" (P. 112)

ISO bracketing

The camera automatically takes pictures at a different ISO sensitivity with the shutter speed and aperture value fixed. 3 images with different exposures are recorded in the order of the set ISO sensitivity (optimum exposure when set to **[AUTO]**), exposure in the – direction, and exposure in the + direction.

Compensation value: 0.3, 0.7 or 1.0

- The compensation value is set in 1/3 EV increments regardless of the ISO step setting.

Number of frames: 3

Menu

MENU ▶ ▶ **[BRACKETING]** ▶ **[ISO BKT]**



Notes

- Bracketing is performed regardless of the upper limit set with **[ISO-AUTO SET]**.
- This function cannot be used when the picture mode is set to an art filter.

Multiple exposure

This overlays multiple frames and saves it as a single image. The image is saved with the record mode set at the time the image is saved.

You can overlay an image while taking a picture or overlay a recorded image in playback mode.

MULTIPLE EXPOSURE

In shooting mode, up to 4 frames of pictures taken can be overlaid and saved as a single image. You can also select a stored RAW image and shoot multiple exposures to create an overlay image.

[FRAME] : Select from **[2F]**, **[3F]**, or **[4F]** for the number of pictures to take.

[AUTO GAIN] : When set to **[ON]**, the brightness of each frame is set to "1/the number of picture taken" and the images are overlaid. When set to **[OFF]**, the images are overlaid with the original brightness of each frame.

[OVERLAY] : When set to **[ON]**, a RAW image recorded on a card can be overlaid with multiple exposures and stored as a separate image. The number of pictures taken is one less than the frames set in **[FRAME]**.

IMAGE OVERLAY

In playback mode, up to 4 frames of RAW images can be overlaid and saved as a single image.



🔍 “Image overlay” (P. 95)

Menu

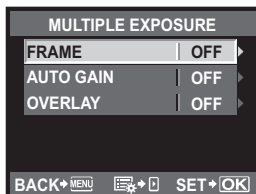
MENU > [C2] > [MULTIPLE EXPOSURE]



Setting display

- When multiple exposure is set,  is displayed on the control panel and super control panel. When shooting is interrupted,  blinks and  is displayed in green on the super control panel.

Control panel

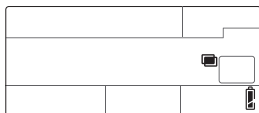

TIPS

To cancel the image during shooting:

→ Pressing the  button cancels the last picture taken.







To shoot multiple exposures while checking the composition for each frame:

→ Take pictures using live view. The overlay images are displayed semi-transparently on the LCD monitor so you can shoot while checking the position of the image overlay.

To overlay 5 or more frames:

→ To overlay 5 or more frames, save the image as a RAW file and use [OVERLAY] to repeat the multiple exposure shooting.

! Notes

- When multiple exposure is set, [SLEEP] is set to [OFF] automatically.
- RAW images taken with another camera cannot be used for the overlay image.
- When [OVERLAY] is set to [ON], the images displayed when a RAW image is selected are developed with the settings at the time of shooting.
- To set the shooting functions, cancel multiple exposure shooting first. Some functions cannot be set.
- Multiple exposure is canceled automatically in the following situations.
 - The camera is turned off/The  button is pressed/The **MENU** button is pressed/The  button is pressed/The battery power runs out/The card is replaced/The LCD monitor is closed/The USB cable, AV cable or the HDMI mini cable is inserted
- The information for the first frame during multiple exposure shooting is displayed as the shooting information.
- When the picture mode is set to  to , multiple exposure is not available with the MYSET or / .

3 Focusing and shooting functions

AF mode selection

AF

The three focus modes S-AF, C-AF, and MF are available with this camera. You can take pictures by combining S-AF or C-AF mode with MF mode.

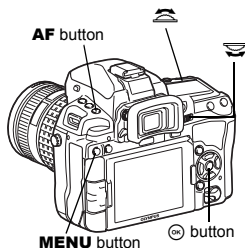
Direct button**AF+** **Super control panel** : [AF MODE]

Setting display

Viewfinder



Control panel

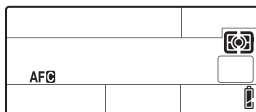

S-AF : S~~AF~~
C-AF : C~~AF~~
MF : -F
S-AF+MF : S~~AF~~ -F
C-AF+MF : C~~AF~~ -F

AF
AF~~Ⓞ~~
MF
MFAF
MFAF~~Ⓞ~~

S-AF (single AF)

Focusing is performed once when the shutter button is pressed halfway. If focusing fails, release your finger from the shutter button and press it halfway again. This mode is suitable for taking pictures of still subjects or subjects with limited movement.

Press the shutter button halfway.

- When the focus is locked, the AF confirmation mark lights up.
- A beep sound is output when the subject is in focus.

Viewfinder



AF confirmation mark

3



Focusing and shooting functions

TIPS

When it is difficult to focus in the AF mode in low-light conditions:

→ The built-in flash can function as an AF illuminator. This makes focusing easier in low-light conditions using AF mode.  "AF ILLUMINAT. (AF Illuminator)" (P. 103)

When you want to quickly switch from AF mode to MF:

→ By registering [MF] to the Fn button, [•••] button or the  (preview) button, you can switch to MF mode just by pressing that button.  "BUTTON FUNCTION" (P. 106)

When you want to be able to shoot even if the subject is not in focus:

→ See "RLS PRIORITY S/RLS PRIORITY C" ( P. 108).

To not light up the AF target in the viewfinder when the subject is in focus:

→ The AF target in the viewfinder lights red when the subject is in focus. You can set the AF target so as not to turn on.  "AF AREA POINTER" (P. 103)

3

C-AF (continuous AF)

The camera repeats focusing while the shutter button remains pressed halfway. When the subject is in motion, the camera focuses on the subject in anticipation of its movement (Predictive AF). Even if the subject moves or you change the composition of the picture, the camera continues trying to focus.

Press the shutter button halfway and keep it in this position.

- When the subject is in focus and locked, the AF confirmation mark lights up.
- The AF target does not light up, even when the subject is in focus.
- The camera repeats focusing. Even if the subject moves or even if you change the composition of the picture, focusing is tried continuously.
- A beep sound is output when the subject is in focus. The beep sound is not output after the third continuous AF operation, even when the subject is in focus.

TIPS

The camera focuses on something passing in front of the subject:

→ You can set the camera so as not to change the focus even if the distance to the subject changes.  "C-AF LOCK" (P. 103)

MF (manual focus)

This function allows you to manually focus on any subject.

Adjust the focus using the focus ring.

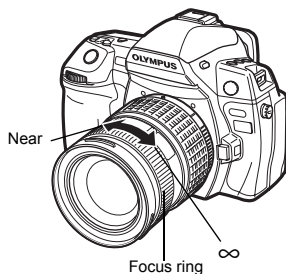

TIPS**To change the rotational direction of the focus ring:**

→ You can select the rotational direction of the focus ring to suit your preference for how the lens adjusts to the focusing point.  "FOCUS RING" (P. 103)

For information on whether the subject is in focus (Focus aid):

→ When you focus the lens on a subject manually (by turning the focus ring), the AF confirmation mark lights. When [∞] is set with [AF AREA], AF confirmation lights up if the subject is in focus at the center AF target. (Only when using the view finder)

To adjust focus precisely (MF assist):

→ You can check the subject enlarged on the display by rotating the focus ring while shooting with live view.  "MF ASSIST" (P. 103)

Simultaneous use of S-AF mode and MF mode (S-AF+MF)

This function allows you to fine-adjust the focus manually by turning the focus ring after AF is performed in the S-AF mode.

- Press the shutter button halfway. After AF is confirmed, rotate the focus ring to fine-adjust the focus.

! Notes

- If the shutter button is pressed again after fine-adjusting the focus with the focus ring, the AF is activated and your adjustments are canceled.

Simultaneous use of C-AF mode and MF mode (C-AF+MF)

Focus with the focus ring and press the shutter button halfway to activate C-AF mode.

- While the shutter button is kept pressed, MF cannot be used.
- When the shutter button is not pressed, focusing with MF is possible.

TIPS**Another way to adjust focus manually in C-AF mode:**

→ You can set the **AEL/AFL** button to operate C-AF.  "AEL/AFL" (P. 105)

! Notes

- If the shutter button is pressed again after fine-adjusting the focus with the focus ring, the AF is activated and your adjustments are canceled.

AF target selection



This camera has 11 AF targets for focusing on the subject with auto focus. Select the optimal AF target mode according to your subject and the composition.

There are two AF target modes: All target AF mode, which uses AF at all AF targets, and Single target AF mode, which uses AF centering around one selected AF target.

All target AF mode

The camera automatically focuses on the subject in front of the camera from among the 11 AF targets. This is useful for shooting moving subjects or relying on the camera for focusing.

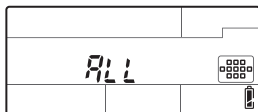
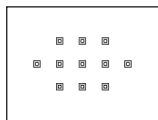

Single target AF mode

Small single target AF mode

The camera focuses using one selected AF target. This is useful for accurately focusing on the subject after composing the shot. With , you can focus using a range that is somewhat larger than one AF target, but you can only set the range within the AF target. When **[SMALL]** is selected for **[AF SENSITIVITY]**, the setting display changes to . "AF SENSITIVITY" (P. 103)

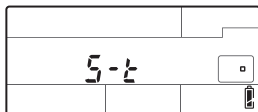

Dynamic single target AF mode

If the camera cannot focus on the subject using the selected AF target, the camera focuses using the adjacent AF target.

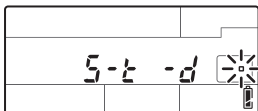
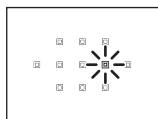
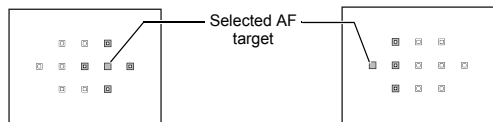

Direct button

- When the button is released, the currently selected AF target lights. When [·] or [::] is set, you can select the AF target to be used at that point. For operation, refer to Step 2 in "Selecting the AF target position" (P. 57) in the next section.

Super control panel

- When [·] or [::] is set, you can turn the dial to select the AF target.

Menu

MENU ▶ [MENU] ▶ [AF] ▶ [AF AREA]

- When [·] or [::] is set, you can select the AF target with [OK].

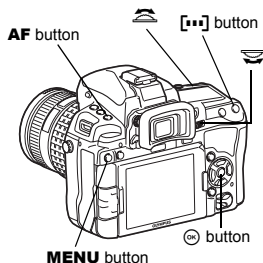
**Selecting the AF target position**

Select the AF target to use with Single target AF mode.

- Press the [AF] button and release your finger to enable selection of the AF target.
- Use the main dial/sub dial or arrow pad to select the AF target.

- Use the main dial to perform the same operation as [OK], and use the sub dial to perform the same operation as [OK].
- Press the [OK] button to return the position of the AF target to the center.

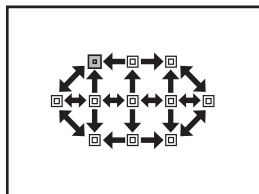
**TIPS****Selecting the operation when the AF target is selected:**

→ You can change the operation of the dials and arrow pad for selecting the AF target.
 [MENU] "AF" SET UP" (P. 102)

Selecting the position of the AF target with the arrow pad without pressing the [AF] button:

→ Press the shutter button halfway and release it, then use the arrow pad to change the position of the AF target. [MENU] "BUTTON FUNCTION" (P. 106)

Performing AF with the specified point:

→ You can perform AF with the position and size of the enlargement frame.
 [MENU] "Enlarged display operation" (P. 40)

Notes

- While shooting using live view, the dynamic-single target AF mode cannot be used.

Registering an AF target mode

You can register a frequently used AF target mode and the position of that AF target. You can then quickly load that registered setting ("home position") and use it when shooting.

Menu

MENU ▶ [Fn] ▶ [AF] ▶ [HOME] SET HOME

Registering

1 Select the position of the AF target and press the **HP** button.

- The home position is registered at the time the buttons are pressed.
- The home position cannot be registered when operating through the direct button.

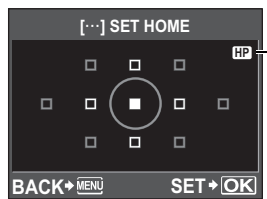

Indicates that the AF target is being registered.

Shooting

In order to use this function, assign [HOME] to any of the **Fn** button, [Fn] button or the **HP** (preview) button in advance. P. 106

1 Press the button to which [HOME] is assigned.

- The registered home position is selected. Press this button again to switch to the original AF target mode.

! Notes

- The AF sensitivity is not recorded when registering the home position.

Sequential shooting



- Single-frame shooting Shoots 1 frame at a time when the shutter button is pressed (normal shooting mode).
- Sequential shooting H Shoots at 5 frames/sec. for as long as the shutter button is pressed (during S-AF, MF).
- Sequential shooting L Shoots at the set speed ("L fps" (P. 108)) for as long as the shutter button is pressed.

- Press the shutter button fully and keep it pressed. The camera will take pictures in sequence until you release the button.
- Focus, exposure, and white balance are locked at the first frame (during S-AF, MF).



Number of sequential shots that can be taken

! Notes

- During sequential shooting, if the battery check blinks due to low battery, the camera stops shooting and starts saving the pictures you have taken on the card. The camera may not save all of the pictures depending on how much battery power remains.

Setting method

Direct button



Super control panel

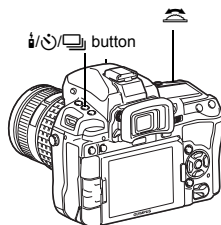
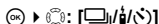

Setting display

Viewfinder	Control panel
Single-frame shooting	
Sequential shooting H : b-d H	
Sequential shooting L : b-d L	
12-second self-timer : SELF 12	
2-second self-timer : SELF 2	
Remote control : r-d 0	
2-second remote control : r-d 2	

- Anti-shock display:
A blinking display in the viewfinder or on the control panel and the symbol on the super control panel indicates that anti-shock is activated.

Self-timer shooting



This function lets you take pictures using the self-timer. You can set the camera to release the shutter after either 12 or 2 seconds. Fix the camera securely on a tripod for self-timer shooting.

For the setting method, see "Sequential shooting" (P. 59).

Press the shutter button all the way.

- When **12s** is selected:
First, the self-timer lamp lights up for approximately 10 seconds, then it blinks for approximately 2 seconds and the picture is taken.
- When **2s** is selected:
The self-timer lamp blinks for approximately 2 seconds, and then the picture is taken.
- To cancel the activated self-timer, press the button.

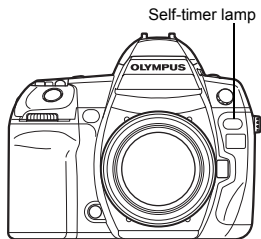

Notes

- Do not press the shutter button while standing in front of the camera; this could result in the subject being out of focus since focusing is performed when the shutter button is pressed halfway.

Eyepiece shutter

When shooting without looking through the viewfinder, close the eyepiece shutter to block the viewfinder so that light does not enter the viewfinder and change the exposure. Lift the eyepiece shutter lever.

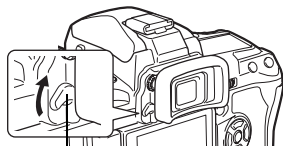

Eyepiece shutter lever

Remote control shooting



By using the optional remote control (RM-1), you can take a picture with yourself in it or a night scene without touching the camera.

The camera can be set to release the shutter either right away or 2 seconds after the shutter button on the remote control is pressed. Bulb shooting is also possible when using the optional remote control.

For the setting method, see "Sequential shooting" (P. 59).

- Eyepiece shutter P. 60

Mount the camera securely on a tripod, point the remote control at the remote control receiver on the camera and press the shutter button on the remote control.

- When **10s** is selected :
The focus and exposure are locked, the remote control lamp blinks and the picture is taken.
- When **12s** is selected :
The focus and exposure are locked, the remote control lamp blinks, and after approximately 2 seconds the picture is taken.

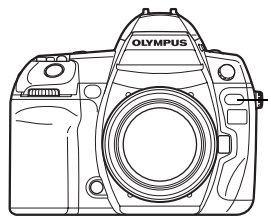

Remote control lamp
Remote control receiver

Transmitted signal effective area

Point the remote control at the remote control receiver of the camera within the effective area as shown below.

When powerful lighting such as direct sunlight is shining on the remote control receiver, or when fluorescent light or devices emitting electrical or radio waves are nearby, it could narrow the effective area.

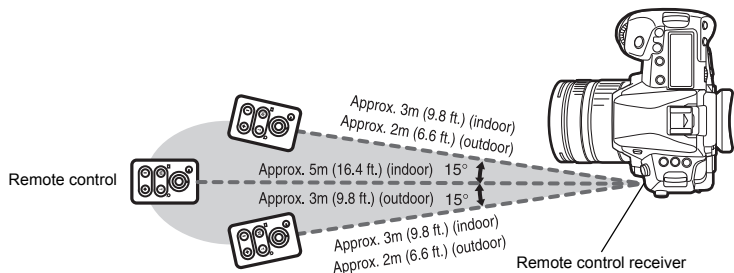

TIPS

The remote control lamp does not blink after the shutter button on the remote control is pressed:

- The transmitted signal may not be effective if the remote control receiver is exposed to powerful lighting. Move the remote control closer to the camera and press the shutter button on the remote control again.
- The transmitted signal may not be effective if the remote control is too far from the camera. Move the remote control closer to the camera and press the shutter button on the remote control again.
- There is signal interference. Point the remote control toward the remote control receiver on the camera and press and hold down the CH button and the W or T zoom button on the remote control at the same time for at least three seconds until the remote control lamp on the camera blinks or a beep sound can be heard, indicating that the signal has been received.

To cancel the remote control shooting mode:

- The remote control shooting mode will not be canceled after shooting. Press the button to set to (single-frame shooting), etc.

To use the shutter button on the camera in the remote control shooting mode:

- The shutter button on the camera still works even in the remote control shooting mode.

! Notes

- The shutter will not be released if the subject is not in focus.
- Under bright light conditions, the remote control lamp may be difficult to see, making it hard to determine whether or not the picture has been taken.
- Zoom is not available on the remote control.

Bulb shooting with the remote control

While holding down the MODE button, turn the main dial to set the shooting mode to **[BULB]**.

"Bulb shooting" (P. 45)

Press the W button on the remote control to open the shutter.
When the time set in "BULB TIMER" (P. 112) elapses, the shutter closes automatically.

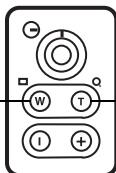

Press the T button to close the shutter.

Anti-shock

You can select the interval from the time the mirror is raised until the shutter is released. This diminishes camera shake caused by vibrations when the mirror moves. This feature can be useful in astrophotography and microscope photography or other photographic situations where a very slow shutter speed is used, and camera vibration needs to be kept to a minimum.

- 1 MENU** ▶ [**%**] ▶ [**IS**] ▶ [ANTI-SHOCK[**♦**]]
- 2** Select the time delay after the mirror is raised and until the shutter is released from 1/8 to 30 seconds and press the  button.
- 3** Anti-shock is added to the shooting functions individually (single-frame shooting, sequential shooting, self-timer shooting, and remote control shooting). For the setting method, see “Sequential shooting” (P. 59).

3

Focusing and shooting functions

Image stabilizer

IS

You can reduce the amount of camera shake that easily occurs when shooting in low light situations or shooting with high magnification.

- OFF** Image stabilizer is off.
- I.S. 1** Image stabilizer is on.
- I.S. 2** This is used for panning with the camera in the horizontal direction to achieve a blurred background. The horizontal image stabilizer is turned off, and only the vertical image stabilizer is activated.
- I.S. 3** This is used for panning with the camera in the vertical direction to achieve a blurred background (tilting). The vertical image stabilizer is turned off, and only the horizontal image stabilizer is activated.

Super control panel





 ▶ : [IMAGE STABILIZER]

Menu

MENU ▶ [**C2**] ▶ [IMAGE STABILIZER]

Setting the focal length

By setting in advance the focal length of the lens, you can use the image stabilizer function with lenses other than Four Thirds system lenses. This setting is deactivated when a Four Thirds system lens is attached.

- 1 Press the  button when the image stabilizer is turned on.
- 2 Use the dial or   to set the focal length and press .



- Choose the value that most closely matches to the one that is printed on the lens.
- You can assign **[IS MODE]** to the **Fn** button to use it as a direct button.

! Notes

- The image stabilizer cannot correct excessive camera shake or camera shake that occurs when the shutter speed is set to the slowest speed. In these cases, it is recommended that you use a tripod.
- When using a tripod, set **[IMAGE STABILIZER]** to **[OFF]**.
- When using a lens with an image stabilization function, turn off the image stabilization function of either the lens or the camera.
- If **[IMAGE STABILIZER]** is set to **[I.S.1]**, **[I.S.2]** or **[I.S.3]** and you turn off the camera, the camera will vibrate. This is due to the camera initializing the image stabilizer mechanism. Without this initialization, the image stabilizer may not be able to achieve the proper effect.
- If the image stabilizer icon blinks in red on the monitor, it indicates a failure of the image stabilizer function. If you take a picture as is, the composition may be off. Consult your Olympus Authorized Service Center.

4 Record mode, white balance, and picture mode

Selecting the record mode

You can select a record mode in which to take pictures. Choose the record mode that is best for your purpose (printing, editing on a PC, website editing, etc.).

Recording formats

JPEG

For JPEG images, select a combination of image size (**L**, **M**, **S**) and compression rate (SF, F, N, B). An image consists of pixels (dots). When you enlarge an image with a low pixel count, it will be displayed as a mosaic. If an image has a high pixel count, the file size (amount of data) will be larger and the number of storable still pictures will be lower. The higher the compression, the smaller the file size. However, the image will have less clarity when played back.

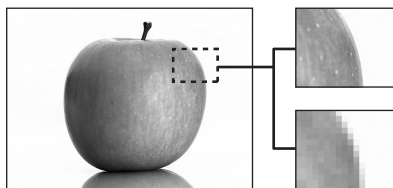

Image with a high pixel count

Image with a low pixel count

Image becomes clearer



Record mode, white balance, and picture mode

Number of pixels increases

Application	Number of pixels	Pixel count	Compression rate			
			SF (Super Fine) 1/2.7	F (Fine) 1/4	N (Normal) 1/8	B (Basic) 1/12
Select for the print size	L (Large)	4032 × 3024	L SF	L F	L N	L B
		3200 × 2400				
	M (Middle)	2560 × 1920	M SF	M F	M N	M B
		1600 × 1200				
For small-sized prints and use on a web site	S (Small)	1280 × 960	S SF	S F	S N	S B
		1024 × 768				
		640 × 480				

RAW

This is unprocessed data that has not undergone changes in white balance, sharpness, contrast or color. To display as an image on the computer, use OLYMPUS Viewer 2 or [ib] software. RAW data cannot be displayed on a different camera or by using common software, and it cannot be selected for print reservation. RAW files are assigned an “.ORF” file extension.

RAW images can be edited with this camera and saved as JPEG data. “Editing still images” (P. 93)

Selecting the record mode

JPEG

For JPEG, you can register 4 combinations of images sizes (**L**, **M**, **S**) and compression rates (SF, F, N, B) from the 12 total combinations available. "SET" (P. 114)
When you select the **M** or **S** image size, you can further select the pixel size.
 "PIXEL COUNT" (P. 114)

JPEG+RAW

Records both a JPEG and RAW image at the same time each time you take a picture.

RAW

Records the image in RAW data format.

e.g.) The following 9 record modes are available when **L**F/**L**N/**M**N/**S**N are registered

RAW : RAW

JPEG : **L**F/**L**N/**M**N/**S**N

JPEG+RAW : **L**F+RAW/**L**N+RAW/**M**N+RAW/**S**N+RAW

Super control panel

: []

Menu

MENU \blacktriangleright [] \blacktriangleright []

TIPS

To quickly set the record mode:

→ By registering [**RAW**] to the **Fn** button, [**+**] button or the (preview) button, you can turn the dial while pressing the button to change the record mode.

Each time you press the button, you can easily switch between JPEG data only and JPEG and RAW data.

"BUTTON FUNCTION" (P. 106)

To find out the file size/number of storable still pictures for each record mode:

→ "Record mode and file size/number of storable still pictures" (P. 144)

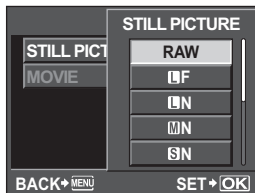
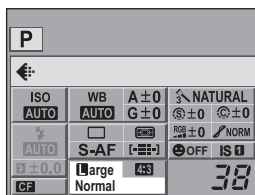

Setting the image aspect

You can change the aspect ratio (horizontal-to-vertical ratio) when taking pictures using live view. Depending on your preference, you can set the aspect ratio to **[4:3]** (standard), **[16:9]**, **[3:2]**, **[6:6]**, **[5:4]**, **[7:6]**, **[6:5]**, **[7:5]**, or **[3:4]**. JPEG images are trimmed and saved according to the aspect ratio.

Super control panel

: [**ASPECT**]

Menu

MENU \blacktriangleright [] \blacktriangleright [**IMAGE ASPECT**]

Notes

- RAW images are not trimmed and are recorded with the aspect ratio information at the time of shooting.
- During RAW image playback, images are displayed with a border based on the aspect ratio.

TIPS**To change the aspect ratio of recorded images:**

→ You can only change the aspect ratio when the aspect ratio of the image is set to [4:3].

"Editing still images" (P. 93)

To trim recorded images:

→ You can only trim images when the aspect ratio of the image is set to [4:3].

"Editing still images" (P. 93)

To shoot with the image aspect ratio when using the view finder:

→ Set [ASPECT SHOOTING] to [ALL].

"ASPECT SHOOTING" (P. 115)

Selecting the white balance

Color reproduction differs depending on the light conditions. For instance, when daylight or tungsten lighting is reflected on white paper, the shade of white produced will be slightly different for each. With a digital camera, white color can be adjusted to reproduce more natural white with a digital processor. This is called white balance. There are 4 options for setting the WB with this camera.

Auto white balance [AUTO]

This function enables the camera to automatically detect white in images and adjust the color balance accordingly. Use this mode for general use.

Preset white balance

7 different color temperatures are preset according to the light source. For example, use preset WB when you want to reproduce more red in the picture of a sunset, or capture a warmer artistic effect under artificial lighting.

Custom white balance [CWB]

You can set the color temperature from 2000K to 14000K. For details on color temperature, refer to "White balance color temperature" (P. 143).

One-touch white balance



You can set the optimum white balance for the shooting conditions by pointing the camera at a white object like a sheet of white paper. The white balance achieved with this setting is saved as one of the preset WB settings.

WB mode	Light conditions
AUTO	Used for most light conditions (when there is a white portion framed in the viewfinder). Use this mode for general use.
5300K	For shooting outdoors on a clear day, or to capture the reds in a sunset or the colors in a fireworks display
7500K	For shooting outdoors in the shadows on a clear day
6000K	For shooting outdoors on a cloudy day
3000K	For shooting under a tungsten light
4000K	For shooting under fluorescent lighting
	For shooting underwater
5500K	For flash shooting
to	Color temperature set by one-touch WB. "Setting the one-touch white balance" (P. 69)
CWB	Color temperature set in custom white balance menu. This can be set from 2000K to 14000K. The factory default setting is 5400K.

Direct button

WB + 

Super control panel

 : [WB]

- Custom white balance is set by selecting [CWB] and turning the dial while pressing down the  button.

Menu

MENU \blacktriangleright [%] \blacktriangleright [P6] \blacktriangleright [WB]

Setting display

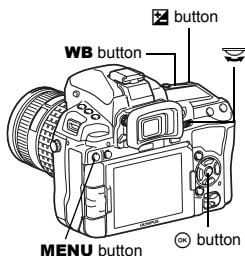
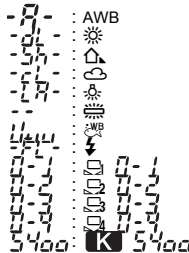
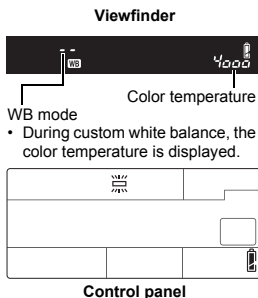

TIPS

When subjects that are not white appear white:

- In the auto WB setting, if there is no near-white color in the image framed in the screen, the white balance will not be correctly determined. In such a case, try preset WB or one-touch WB settings.

White balance sensor

This camera has a white balance sensor for determining the light source in the shooting environment. The white balance sensor measures and calculates the infrared and visible light, and determines whether the light source is sunlight, fluorescent lighting, floodlighting, a blue flat lamp, or other lighting. When shooting, be careful not to cover or shade the sensor.

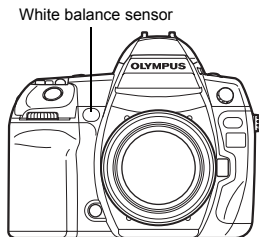

WB compensation

This function lets you make fine changes to the auto WB, preset WB settings and the one-touch WB.

Direct button

WB + [A] ▶ **[G]**: adjust in A direction/
[G]: adjust in G direction

- Use the sub dial to set in the A direction or the main dial to set in the G direction.

Super control panel

[WB]

Menu

MENU ▶ **[%]** ▶ **[WB]**

- Select the white balance to adjust and press **[WB]**.

Adjusting the white balance in the A direction (Amber-Blue)

Depending on the original WB conditions, the image will become more amber when adjusted toward +, and bluer when adjusted toward -.

Adjusting the white balance in the G direction (Green-Magenta)

Depending on the original WB conditions, the image will become greener when adjusted toward +, and magenta when adjusted toward -.

- The white balance can be adjusted in 7 increments in each direction.

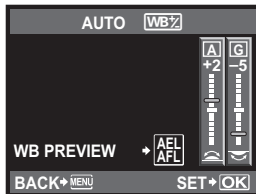

Direct buttons setting screen

Setting display

e.g. 1) When the A direction and G direction are each adjusted toward -

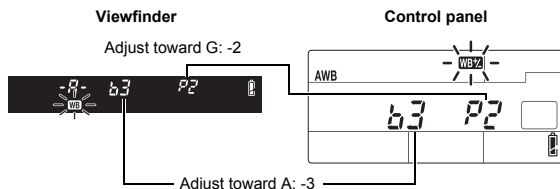

e.g. 2) When the A direction and G direction are each adjusted toward +

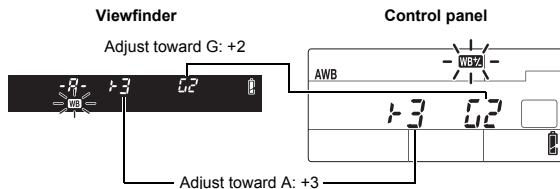

TIPS

Checking the white balance you have adjusted:



→ After setting the compensation value, point the camera at the subject to take test shots. When the **AEL/AFL** button is pressed, sample images that have been taken with the current WB settings are displayed.

Adjusting all WB mode settings at once:

→ See "ALL **[WB]**" (P. 113).

Setting the one-touch white balance

This function is useful when you need a more precise white balance than preset WB can provide. Point the camera at a sheet of white paper under the light source you want to use to determine the white balance. The optimum white balance for the current shooting conditions can be saved in the camera. This is useful when shooting a subject under natural light, as well as under various light sources with different color temperatures.

Assign **[**] to any of the **Fn** button, **[**] button or the **[**] (preview) button in **[BUTTON FUNCTION]** in advance. (P. 106)



1 Point the camera at a sheet of white paper.

- Position the paper so that it fills the viewfinder. Make sure there are no shadows.

2 While holding down the button to which **[**] is assigned, press the shutter button.

- The one-touch white balance screen appears.

3 Select between **[**] to **[**] and press the **[**] button.

- The white balance is registered.
- The registered white balance will be stored in the camera as a preset WB setting. Turning the power off does not erase the data.
- Alternatively, press the **WB** button to select between **[**] to **[**], then press the **[**] button to register the white balance.

TIPS

After pressing the shutter button, **[WB NG RETRY]** is displayed:

→ When there is not enough white in the image, or when the image is too bright, too dark or the colors look unnatural, you cannot register the white balance. Change the aperture and shutter speed settings, then repeat the procedure from Step 1.

WB bracketing

Three images with different white balances (adjusted in specified color directions) are automatically created from one shot. One image has the specified white balance, while the others are the same image adjusted in different color directions.

Direct button

WB + MODE **[**]: EV step in A-B direction/
[]: EV step in G-M direction

- Use the sub dial to set in the A-B direction or the main dial to set in the G-M direction.

Menu

MENU **[**] **[BRACKETING]** **[**]

Setting display

When using the direct button

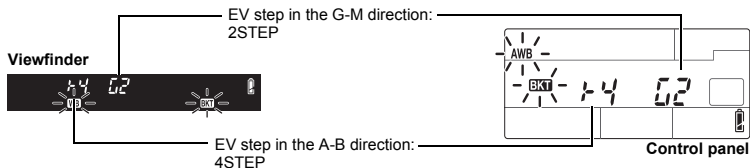

- Select from [OFF], [3F 2STEP], [3F 4STEP], or [3F 6STEP] for the EV step for both the A-B (amber-blue) direction and the G-M (green-magenta) direction.
- When the shutter button is pressed down all the way, 3 images adjusted in specified color directions are automatically created.

When using the menu

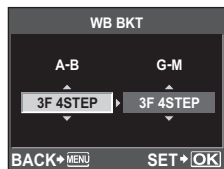

4

Record mode, white balance, and picture mode

TIPS

To apply WB bracketing to the white balance you have adjusted:

→ Adjust white balance manually, then use the WB bracketing feature. WB bracketing is applied to the white balance you have adjusted.

Notes

- During WB bracketing, the camera cannot shoot the pictures if there is not enough memory in the camera and card for storing at least the selected number of frames.
- This function cannot be used when the picture mode is set to an art filter.

Picture mode

You can select the art filter or finish according to the shooting purpose. For image tones (finish), you can also fine-adjust image parameters such as contrast and sharpness for each item. The adjusted parameters are recorded in each picture effect mode.

Super control panel

[PICTURE MODE]

Menu

MENU > [P] >
[PICTURE MODE]

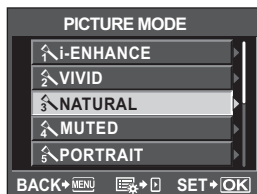

- [1] **i-ENHANCE** : Produces more impressive-looking pictures matched to the scene mode.
- [2] **VIVID** : Produces vivid colors.
- [3] **NATURAL** : Produces natural colors.
- [4] **MUTED** : Produces flat tones.
- [5] **PORTRAIT** : Produces beautiful skin tones.
- [MONOTONE]** : Produces black and white tone.
- [CUSTOM]** : Select one picture mode, set the parameters, and register the setting.

Press  to adjust the parameter. The adjustable parameters differ depending on the items.

The individual parameters are as follows.

- [CONTRAST]** : Distinction between light and dark
- [SHARPNESS]** : Sharpness of the image
- [SATURATION]** : Vividness of the color
- [GRADATION]** : Adjust tone (gradation).

[AUTO] : Divides the image into detailed regions and adjusts the brightness separately for each region. This is effective for images with areas of large contrast in which the whites appear too bright or the blacks appear too dark.

[NORMAL] : Use **[NORMAL]** mode for general uses.

[HIGH KEY] : Gradation for a bright subject.

[LOW KEY] : Gradation for a dark subject.

[EFFECT] : Sets the extent that the effect will be applied. (i-ENHANCE)

[B&W FILTER] : Creates a black and white image. The filter color is brightened and the complementary color is darkened. (MONOTONE)

[N: NEUTRAL] : Creates a normal black and white image.

[Ye: YELLOW] : Reproduces clearly defined white cloud with natural blue sky.

[Or: ORANGE] : Slightly emphasizes colors in blue skies and sunsets.

[R: RED] : Strongly emphasizes colors in blue skies and brightness of crimson foliage.

[G: GREEN] : Strongly emphasizes colors in red lips and green leaves. (MONOTONE)

[PICT. TONE] : Colors the black and white image.

[N: NEUTRAL] : Creates a normal black and white image.

[S: SEPIA] : Sepia

[B: BLUE] : Bluish

[P: PURPLE] : Purplish

[G: GREEN] : Greenish

- [ART] **POP ART**
- [ART] **SOFT FOCUS**
- [ART] **PALE&LIGHT COLOR**
- [ART] **LIGHT TONE**
- [ART] **GRAINY FILM**
- [ART] **PIN HOLE**
- [ART] **DIORAMA**
- [ART] **CROSS PROCESS**
- [ART] **GENTLE SEPIA**
- [ART] **DRAMATIC TONE**

Select and press the  button.

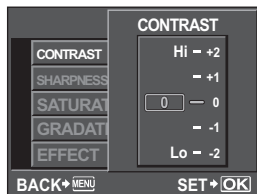
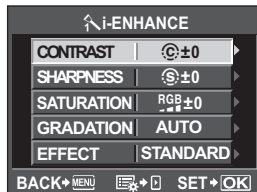

! Notes

- [P₁ POP ART] to [P₁₀ DRAMATIC TONE] are not applied to RAW images.
- If the record mode is set to [RAW] and [P₁ POP ART] to [P₁₀ DRAMATIC TONE] are applied, the record mode is automatically set to [LN+RAW].
- The grainy appearance of the picture may be emphasized when [P₁ POP ART] to [P₁₀ DRAMATIC TONE] are applied.
- When you set to [P₁₀ DRAMATIC TONE] while the ISO sensitivity is set to AUTO, the upper limit of the sensitivity is 1600. You can set it to higher than 1600 by setting to other than ISO AUTO. In this case, however, the filter is less effective. In addition, the effect of the exposure compensation may not be obtained.
- When any of [P₁ POP ART] through [P₁₀ DRAMATIC TONE] is applied, [COLOR SPACE] on the menu is not available.

TIPS

You can set whether to display/hide each item on the screen. "PICTURE MODE SETTINGS" (P. 111)

4

Record mode, white balance, and picture mode

Noise reduction

This function reduces the noise that is generated during long exposures. When shooting night scenes, shutter speeds are slower and noise tends to appear in images. With [NOISE REDUCT.], you can let the camera reduce noise automatically to produce clearer images. When set to [AUTO], noise reduction will be activated only when the shutter speed is slow. When set to [ON], noise reduction will always be activated. While noise reduction is activated, it takes about twice the usual time to take a picture.



OFF



ON/AUTO

Menu

MENU > [P₁] > [P₁₀] > [NOISE REDUCT.]

- The noise-reduction process is activated after shooting.
- The card access lamp blinks and [busy] is displayed on the viewfinder while noise reduction is operating. You cannot take more pictures until the card access lamp turns off.

Noise reduction [ON]

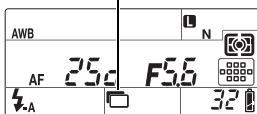

! Notes

- During sequential shooting, [NOISE REDUCT.] is [OFF] automatically.
- This function may not work effectively with some shooting conditions or subjects.

Noise filter

You can select the noise processing level. Use [STANDARD] for general use. [HIGH] is recommended during high sensitivity shooting.

Menu

MENU > [P₁] > [P₁₀] > [NOISE FILTER]

Flash mode setting



The camera sets the flash mode according to various factors such as firing pattern and flash timing. Available flash modes depend on the exposure mode. The flash modes are available to optional external flashes.

Auto flash AUTO

The flash fires automatically in low light or backlight conditions. To shoot a subject with backlighting, position the AF target over the subject.

Flash synchronization speed/Slow limit

Shutter speed can be changed when the built-in flash fires. "X-SYNC." (P. 112), "SLOW LIMIT" (P. 112)

Red-eye reduction flash

In the red-eye reduction flash mode, a series of pre-flashes are emitted just before the regular flash fires. This helps accustom the subject's eyes to the bright light and minimizes the red-eye phenomenon. In **S/M/BULB** mode, the flash always fires.



The subject's eyes appear red

Notes

- After the pre-flashes, it takes about 1 second before the shutter is released. Hold the camera firmly to avoid camera shake.
- Effectiveness may be limited if the subject is not looking directly at pre-flashes, or if the shooting range is too far. Individual physical characteristics may also limit effectiveness.

Slow synchronization (1st curtain) SLOW

The slow synchronization flash is designed for slow shutter speeds. Normally, when shooting with a flash, shutter speeds cannot go below a certain level to prevent camera shake. But when shooting a subject against a night scene, fast shutter speeds can make the background too dark. Slow synchronization allows you to capture both the background and the subject. Since the shutter speed is slow, be sure to stabilize the camera by using a tripod so as not to cause the picture to be blurred.



1st curtain

Usually, the flash fires right after the shutter fully opens. This is called 1st curtain. This method is usually used during flash shooting.

Slow synchronization (2nd curtain) ⚡ SLOW2

2nd curtain flash fires just before the shutter closes. Changing the flash timing can create interesting effects in your picture, such as expressing the movement of a car by showing the tail-lights streaming backwards. The slower the shutter speed, the better the effects turn out. In **S/M/BULB** mode, the flash always fires.

When the shutter speed is set to 2 sec.

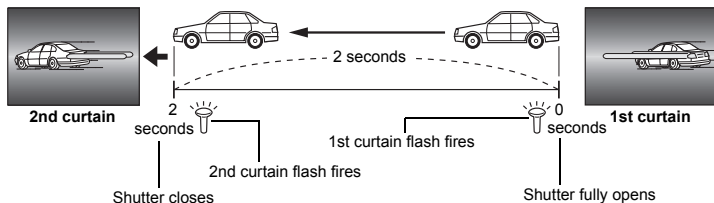

Slow synchronization (1st curtain)/Red-eye reduction flash 👁 SLOW

While using slow synchronization with flash shooting, you can also use this function to achieve red-eye reduction. When shooting a subject against a night scene, this function allows you to reduce the red-eye phenomenon. As the time from emitting pre-flashes to shooting is long in 2nd curtain synchronization, it is difficult to achieve red-eye reduction. Hence, only 1st curtain synchronization setting is available.

Fill-in flash ⚡

The flash fires regardless of the light conditions. This mode is useful for eliminating shadows on the subject's face (such as shadows from tree leaves), in a backlight situation, or for correcting the color shift produced by artificial lighting (especially fluorescent light).



! Notes

- When the flash fires, the shutter speed is set to 1/250 sec. or less. When shooting a subject against a bright background with the fill-in flash, the background may be overexposed. In this case, use the optional FL-50R external flash or a similar flash and shoot in the Super FP flash mode. 🗨 "Super FP flash" (P. 79)

Flash off 🔕

The flash does not fire.

Even in this mode, the flash can be used as an AF illuminator when it is raised. 🗨 "AF ILLUMINAT. (AF Illuminator)" (P. 103)

Manual flash

This allows the built-in flash to output a fixed amount of light. To shoot with manual flash, set the f-number on the lens based on the distance to the subject.

Ratio of amount of light	GN: Guide number ISO 200 (Equivalent to ISO 100)
FULL (1/1)	18 (13)
1/4	9 (6.5)
1/16	4.5 (3.3)
1/64	2.3 (1.6)

Calculate the f-number on the lens using the following formula.

$$\text{Aperture (f-number)} = \frac{\text{GN} \times \text{ISO sensitivity}}{\text{Distance to the subject (m)}}$$

ISO sensitivity

ISO value	100	200	400	800	1600	3200	6400
ISO sensitivity	1.0	1.4	2.0	2.8	4.0	5.6	8.0

Setting method

Direct button



Super control panel

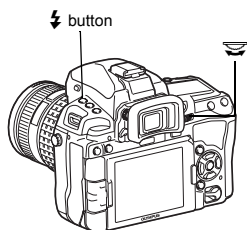

Setting display

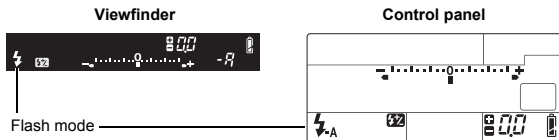

- For details on displaying the settings, refer to “Flash modes that can be set by shooting mode” (P. 142).

Built-in flash shooting

If you shoot a subject using a lens that is wider than 14mm (equivalent to 28mm on a 35mm film camera), the light emitted by the flash may produce a vignette effect. Whether or not vignetting occurs also depends on lens type, hood and shooting conditions (such as distance to the subject).

- 1 Press the **⚡ UP** button to raise the built-in flash.

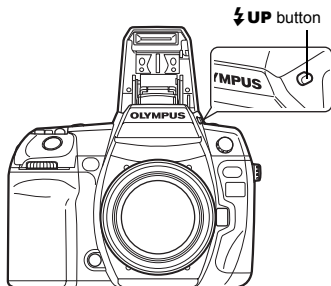

5

Flash shooting

- 2 Press the shutter button halfway.
 - The **⚡** (flash stand-by) mark lights when the flash is ready to fire. If the mark is blinking, the flash is charging. Wait until charging is complete.
- 3 Press the shutter button all the way.

Flash stand-by mark

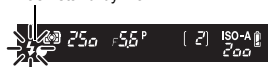

Viewfinder

TIPS

To shoot without having to wait for the flash to finish charging:

→ See "RLS PRIORITY S/RLS PRIORITY C" (P. 108).

Notes

- When [**⚡ RC MODE**] is set to [**ON**], the built-in flash will fire only to communicate with the external flash so it will not function as a flash. See "Shooting with the Olympus wireless RC flash system" (P. 80)

Flash intensity control

The flash intensity can be adjusted from +3 to -3.

In some situations (e.g., when shooting small subjects, distant backgrounds, etc.), you may get better results by adjusting the amount of light emitted by the flash ("flash intensity"). It is useful when you intend to increase the contrast (distinction between light and dark) of images to make the images more vivid.

Direct button



Super control panel

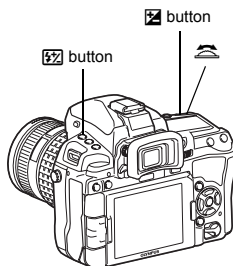

Setting display

Viewfinder



Control panel

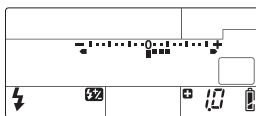

TIPS

To adjust the flash using only the dials:

→ Assign the flash intensity control function to the main dial (or sub dial). "DIAL FUNCTION" (P. 104)

! Notes

- This does not work during manual flash.
- This does not work when the flash control mode on the electronic flash is set to MANUAL.
- If flash intensity is adjusted on the electronic flash, it will be combined with the camera's flash intensity setting.
- When + is set to **[ON]**, the flash intensity value will be added to the exposure compensation value. + (P. 112)

Flash bracketing

The camera shoots multiple frames, changing the amount of light emitted by the flash for each shot. The camera shoots 3 frames at a time with the following amount of light: optimum light, light adjusted in the - direction, and light adjusted in the + direction.

Menu

MENU ▶ ▶ **[BRACKETING]** ▶ **[FL BKT]**

- The compensation value will change according to the EV step. "EV STEP" (P. 111)
- In single-frame shooting, the amount of light emitted by the flash changes every time the shutter button is pressed.
- In sequential shooting, hold down the shutter button until the selected number of frames are taken.
- Releasing the shutter button stops flash bracketing shooting. When it stops, **[BKT]** blinks in the viewfinder and on the control panel and **[BKT]** is displayed in green on the super control panel.

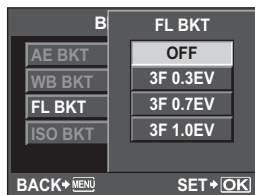

External flash shooting

In addition to the camera's built-in flash capabilities, you can use any of the external flash units specified for use with this camera. This enables you to take advantage of a wider variety of flash shooting techniques to suit different shooting conditions.

The external flashes communicate with the camera, allowing you to control the camera's flash modes with various available flash control modes, such as TTL-AUTO and Super FP flash. An external flash unit specified for use with this camera can be mounted on the camera by attaching it to the camera's hot shoe. You can also attach the flash to the flash bracket on the camera using the bracket cable (optional).

Refer to the external flash's manual as well.

Functions available with external flash units

Optional flash	FL-50R	FL-36R	RF-11	TF-22
Flash control mode	TTL-AUTO, AUTO, MANUAL, FP TTL AUTO, FP MANUAL		TTL-AUTO, MANUAL	
GN (Guide number) (ISO100)	GN50 (85 mm [*]) GN28 (24 mm [*])	GN36 (85 mm [*]) GN20 (24 mm [*])	GN11	GN22
RC mode	✓	✓	—	—

* The focal length of the lens that can be used (Calculated based on 35 mm film camera)

Notes

- The FL-40 optional flash cannot be used.

Using the external electronic flash

Be sure to attach the flash to the camera before turning on the flash's power.

- 1 Remove the hot shoe cover by sliding it in the direction indicated by the arrow in the illustration.**

- Keep the shoe cover in a safe place to avoid losing it, and put it back on the camera after flash shooting.

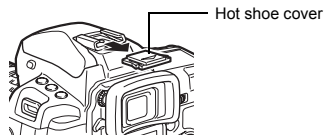

- 2 Attach the electronic flash to the hot shoe on the camera.**

- If the lock pin is protruding, turn the shoe lock ring as far as it will go in the direction opposite to LOCK. This will pull the lock pin back inside.

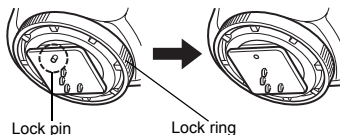

3 Turn on the flash.

- When the charge lamp on the flash lights up, charging is complete.
- The flash will be synchronized with the camera at a speed of 1/250 sec. or less.

4 Select a flash mode.

5 Select the flash control mode.

- TTL-AUTO is recommended for normal use.

6 Press the shutter button halfway.

- Shooting information such as ISO sensitivity, aperture value, and shutter speed is communicated between the camera and flash.

7 Press the shutter button all the way.

! Notes

- The built-in flash cannot be used when an external flash is attached to the hot shoe.

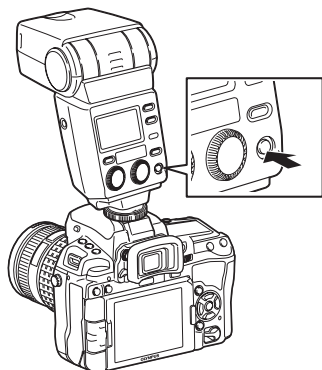

Super FP flash

Super FP flash is available with the FL-50R or FL-36R. You can use the Super FP flash even where normal flashes cannot be used with high shutter speed.

Fill-in flash shooting with the aperture open (such as in outdoor portrait shooting) is also possible with Super FP flash. For details, refer to the external flash's manual.

Super FP flash



Shooting with the Olympus wireless RC flash system

Wireless flash shooting is possible with the Olympus wireless RC flash system. With this wireless flash system, you can take pictures using multiple wireless flashes and control the flashes in three groups (A, B, and C). The built-in flash is used to communicate between the camera and the external flashes.

For details on using the wireless flash, see the manual of the external flash.

Wireless flash setup range

Position the wireless flash so that the wireless sensor faces the camera. The setup range guidelines are as shown below. The range changes according to the surrounding environment.

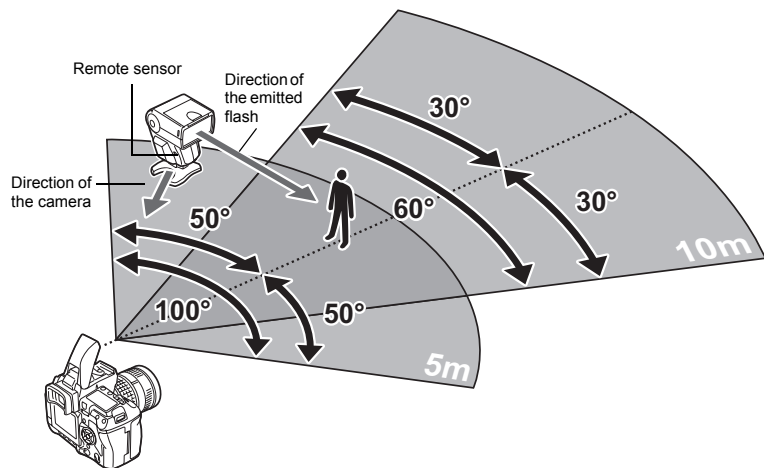

5 Flash shooting

- 1 Position the flash while referring to the “Wireless flash setup range”, and turn on the flash.
- 2 Press the **MODE** button on the flash to set it to RC mode, and set the channel and group of the flash.
- 3 Set RC mode on the camera to [ON].
 - **MENU** > [] > [⚡ RC MODE] > [ON]
 - The super control panel switches to RC mode.
 - You can press the **INFO** button to switch the super control panel display.

4 Use the super control panel to set the flash mode and other settings for each group.

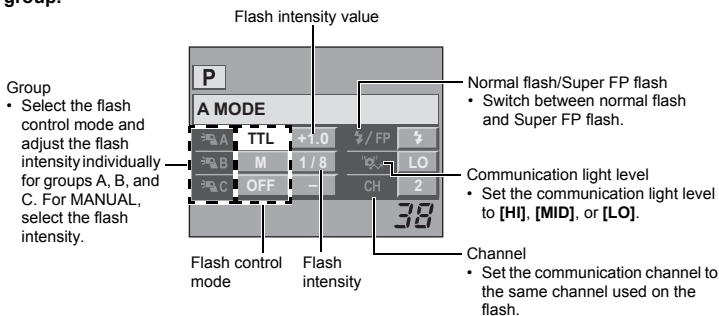

5 Select a flash mode.

- Red-eye reduction flash is not possible in RC mode.

6 Press the **UP** button to raise the built-in flash.

7 After shooting preparations are completed, take some test shots to check the flash operation and images.

8 Begin shooting while checking the charging completed indications of the camera and flash.

! Notes

- Although there is no limit to the number of wireless flashes you can use, it is recommended that each group have no more than three flashes to prevent flash malfunction due to mutual interference.
- In RC mode, the built-in flash is used to control the wireless flash. The built-in flash cannot be used for flash shooting in this mode.
- For 2nd curtain synchronization, set the shutter speed and anti-shock settings to within 4 seconds. Wireless flash shooting may not operate properly when using a slower shutter speed or anti-shock setting.

Using commercially available flashes

You cannot use the camera to adjust the amount of light emitted from a commercially available flash except for a flash specified for use with this camera. To use a commercially available flash, connect it to the hot shoe or connect the synchronization cord to the external flash connector. Set the camera's shooting mode to **M**. For details on non-specified commercial flashes, see "Non-specified commercial flashes" (P. 82).

1 Remove the hot shoe cover to connect the flash unit to the camera.

2 Set the shooting mode to **M, then set the aperture value and shutter speed.**

- Set the shutter speed to 1/250 sec. or slower. If the shutter speed is faster than this, commercially available flashes cannot be used.
- A slower shutter speed may produce blurred images.

3 Turn on the flash.

- Be sure to turn on the flash after attaching the flash unit to the camera.

4 Set the ISO sensitivity and aperture value on the camera to match the flash control mode on the flash.

- Refer to the flash's manual for instructions on how to set its flash control mode.

Notes

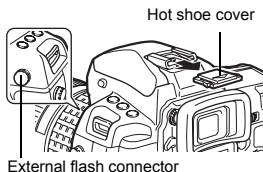

- The flash fires each time the shutter is released. When you do not need to use the flash, turn off the flash's power.
- Check beforehand that the flash you are using is synchronized with the camera.



Non-specified commercial flashes

- 1) Some commercially available flashes require a voltage of 250V or more for the synchronization connector. The use of this type of flash can damage the camera or prevent the camera from operating properly. Contact the manufacturer of the flash for the specifications of the flash synchronization connector.
- 2) Some commercially available flashes have a synchronization connector with reversed polarity. This type of flash does not work with this camera. Contact the manufacturer of the flash.
- 3) Exposures when using a flash require that adjustments be made on the flash. If a flash is used in the auto mode, match it with the f-number and ISO sensitivity settings on the camera.
- 4) Even if the flash auto f-number and ISO sensitivity are set the same as on the camera, the correct exposure may not be obtained depending on the shooting conditions. In such a case, adjust the auto f-number or ISO on the flash or calculate the distance in the manual mode.
- 5) Use a flash with an illumination angle that matches the focal length of the lens. The focal length of the lens for 35 mm film is approximately twice as long as the focal length of the lenses designed for this camera.
- 6) Do not use a flash unit or other accessory TTL flash that has additional communication functions other than the specified flashes, since it may not only fail to function normally, but may also cause damage to the camera's circuitry.

6 Recording and viewing movies

During live view, use the  (movie) button to record High Definition (HD) movies with sound.  “Shooting” (P. 15)

Recording movies

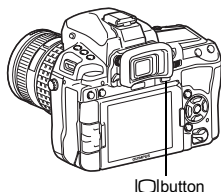

1 Activate live view.

- Press the  button when shooting the pictures using the view finder.



 button

2 Set to the desired shooting mode.

- The movie is recorded in a shooting mode when  (movie) button is pressed. However, it is recorded in **P** (program shooting) mode when **S** (shutter priority shooting) has been set.
- **[P]**: Optimal aperture is set automatically according to the brightness of the subject. ISO sensitivity is set to AUTO.
- **[A]**: Depiction of background is changed by setting the aperture. ISO sensitivity is set to AUTO.
- **[M]**: You control both aperture and shutter speed. Select the shutter speed from values between 1/30 s and 1/4000 s. Sensitivity can be set manually to values between ISO 200 and 1600.
-  to  can be set as a picture mode of **P/A/M**.

3 Press the shutter button halfway to focus.

4 Press the (movie) button to begin recording. Press the (movie) button again to end recording.

- Recording audio also begins at the same time. (When **[MOVIE]** is **[ON]**.)



Glow red during recording

Recorded time

TIPS

To shoot a still picture during recording a movie:

→ Press the shutter button during recording a movie to pause the movie recording and shoot a still picture. After shooting the still picture, movie recording is resumed. In this case three files are recorded.

To adjust focus again during recording a movie:

→ Press the AEL/AFL button or press the shutter button halfway to perform AF.

- The sound made by the lens operating may be recorded.
- By connecting a commercially available microphone to the microphone connector, the lens operation sound recorded can be reduced.

! Notes

- When recording a movie, you cannot change the settings for exposure compensation and aperture value, and shutter speed.
- If **[IMAGE STABILIZER]** is activated while recording a movie, the recorded image is enlarged slightly. Even if **[I.S.2]** or **[I.S.3]** is selected, the setting for **[I.S.1]** is applied.
- Stabilization is not possible when the camera shake is excessive.
- When using a lens with the image stabilizer function, turn off the image stabilizer function of either the lens or the camera.
- You cannot use  **FACE DETECT** in movie mode.

- The size of each movie file is limited to 2GB. With some types of card to be used, recording may be interrupted unexpectedly before reaching the end of available recording time.
- When the inside of the camera becomes hot, shooting is automatically stopped to protect the camera.
- While the card access lamp is blinking, the next recording is not allowed.
- It is recommended to use SD speed class 6 or higher compatible card for movie shooting.
- The camera may not correctly display the recording time in art filter mode. Movies recorded in [ART7] (DIORAMA) mode play back at high speed; during recording, the recording time is adjusted to reflect the playback time and advances more slowly than usual.
- When the picture mode is set to [i-ENHANCE], the movie is recorded with [NATURAL].

Changing the movie record mode

Live control



Menu

MENU ▶ [MOVIE] ▶ [MOVIE]



6

Recording and viewing movies

HD	The number of pixels is 1280 x 720. You can record high-definition movies.
SD	The number of pixels is 640 x 480.

Recording sound

Live control



Menu

MENU ▶ [MOVIE] ▶ [MOVIE]

! Notes

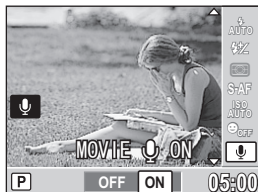

- When recording sound in a movie, the sound made by the lens and camera operating may be recorded.
- No sound is recorded in [ART7] (DIORAMA) mode.





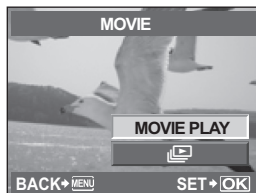



Viewing movies

- 1** Display a movie in single-frame playback and press the  button.



- 2** Select [MOVIE PLAY] using   and press the  button to begin playback.

- The following operations can be performed during movie playback.

	<p>Pause or resume playback.</p> <ul style="list-style-type: none"> While playback is paused, press  to display the first frame and press  to display the last frame. Press  to rewind or advance one frame. Press and hold the button to rewind or advance in succession. 	
	<p>Advance or rewind a movie.</p>	
 / 	<p>Adjust volume.</p>	

7 Playback functions

Single-frame/Close-up playback



The basic procedure for viewing pictures are as shown below.

However, before using any of these functions, follow Step 1 below. You can set the camera to automatically switch to single-frame playback mode after shooting. "REC VIEW" (P. 99)

1 Press the button (Single-frame playback).

- The last recorded image appears.
- The LCD monitor turns off after more than 1 minute if no operations are performed. The camera will turn off automatically if there is no operation after 4 hours. Turn on the camera again.

2 Use or to select images you want to view. You can also turn to switch to for close-up playback.

- You can switch the operations of both dials. P. 104

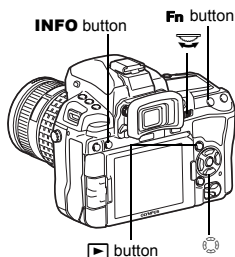

(Single-frame playback)

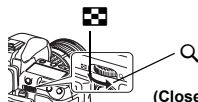

(Close-up frame-by-frame playback)



Press or to view frame-by-frame close-ups. When FACE DETECT is set to [ON], press to move to another face in close-up position.



- : Displays the next frame
- : Displays the previous frame

(Close-up position playback)

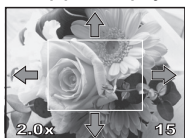

Press to move the display of the close-up position. When FACE DETECT (P. 38) is set to [ON], a frame is displayed around a detected face. Press to move the frame to another face.

- Press the **Fn** button
- Plays back the image at a 10x magnified close-up position.

button

- The menu for the displayed image type is displayed.



(Close-up playback)



Press to change the close-up position.

- To exit the playback mode, press the button again.
- Pressing the shutter button halfway resumes the shooting mode.

INFO/Fn

Light box display

You can view the playback image and another image together on the left and right sides of the monitor. This is useful if you want to compare images you recorded using bracketing.

1 Press the **[•••]** button during single-frame playback.

- The frame being viewed is displayed on the left side of the monitor, and the next frame is displayed on the right side. The image is displayed at the same magnification of the image being viewed.
- The image on the left is the benchmark image.

2 Press **[⏪]**, **[⏩]** to select the image on the right.

- You can protect, erase or copy the image on the right.

3 Press the **[•••]** button.

- The camera returns to single-frame playback of the image on the left at the magnification being viewed.

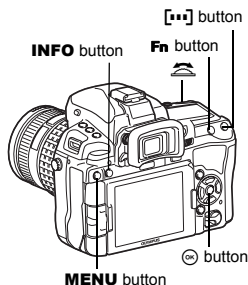

Benchmark image

Operations during light box display

- Pressing the **[↺]** button replaces the image on the left with the image on the right and becomes the new benchmark image.
- You can use the dial to change the magnification of both images at the same time.
- Pressing the **Fn** button or **INFO** button allows you to move the position of the image on the right with the **[⏪]** button. Pressing the **Fn** button or **INFO** button again allows you to move the positions of both images with the **[⏪]** button.

[↺] : Selects the right image

[⏪] : Scrolls the right image

[⏪] : Scrolls both images in synchronization

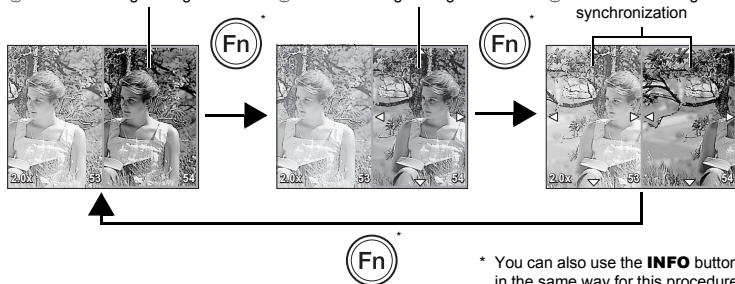

* You can also use the **INFO** button in the same way for this procedure.





This function lets you show several images on the monitor at the same time. This is useful when you want to quickly search a number of pictures to find a particular image.

During single-frame playback, each time you turn the dial toward , the number of images shown changes between 4, 9, 25 and 100 pictures.

 : Moves to the previous frame

 : Moves to the next frame

 : Moves to the upper frame

 : Moves to the lower frame

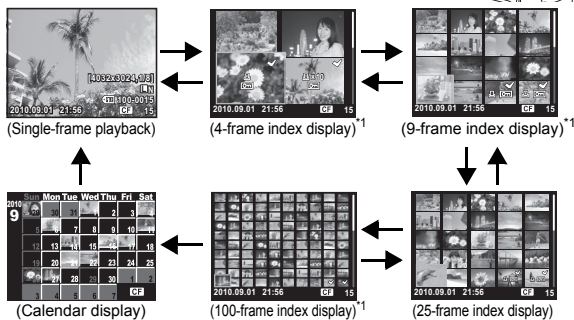
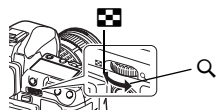
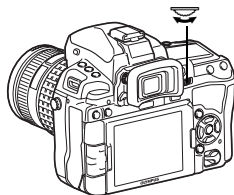

• To return to single-frame playback, turn the main dial to .



*1 It is displayed when "/INFO SETTINGS" ( P. 109) is [ON].

Calendar display

With the calendar, you can display images recorded on the card by date. If more than one image was taken on a single date, the image shot first on that date is displayed.

Use  to select a date and press the  button to play back images for the selected date in single-frame display.

This allows you to display detailed information about the image.
Luminance information can also be displayed with histogram and highlight graphs.

Press the INFO button repeatedly until the desired information is displayed. You can also switch the information displayed by turning the dial while pressing the INFO button.

- This setting is stored and will be shown the next time the information display is called up.

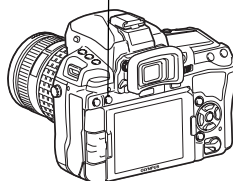
INFO button

Image only

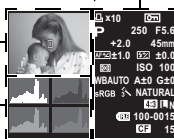
Simplified display

**Highlight/
Shadow display**

**Shooting
information**
Histogram*
**Overall
display**
***Histogram**

If the bars in the histogram are higher on the right, the image may be too bright. If the bars are higher on the left, the image may be too dark. Compensate the exposure or shoot again.

Highlight&Shadow*1

Over- or underexposed parts of the recorded image are displayed.

Highlights (overexposed) parts will be shown in red.
Shadows (underexposed) parts will be shown in blue.

Histogram display*1

Distribution of the brightness of the recorded image is displayed in a histogram (brightness component graph).

*1 It is displayed when "INFO SETTINGS" (P. 109) is [ON].

TIPS

To quickly switch to the frequently used display:

- You can hide the information display for all modes except "Simplified display".
"INFO SETTINGS" (P. 109)
- To change the warning tone range indicated on the Highlight&Shadow display
"HISTOGRAM SETTINGS" (P. 109)

Slideshow

This function displays images stored on the card one after another. The images are played back in order, starting with the displayed image.

1 MENU ▸ [▶] ▸ [📷]

- Press the **OK** button during playback to select slideshow.

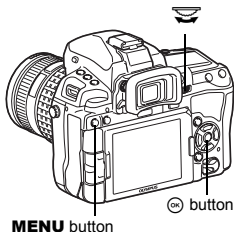
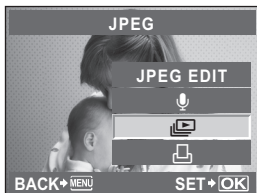

2 Perform slideshow settings.

[START] : Perform slideshow using current settings.

[BGM] : Set BGM or turn BGM **[OFF]**.

[SLIDE] : Set the items for slideshow.

[SLIDE INTERVAL] :

Sets interval at which to switch images from 2-10 seconds.

[MOVIE INTERVAL] :

When playing a movie, select **[FULL]** to play the entire movie, or **[SHORT]** to play to a section part-way through.

3 Select **[START]** and press the **OK** button.

- The slideshow will start.

4 Press the **OK** button to stop the slideshow.

Operations during slideshow

- Press **[VOL+]** **[VOL-]** to adjust the overall volume (only when playing back sound using the camera speaker).
- Press **[BAL]** while the volume adjustment screen is displayed to adjust the balance between BGM and recorded sound.

! Notes

- If the slideshow is left running for about 30 minutes while using the battery, the camera will turn off automatically.

Rotating images

This function lets you rotate images and display them vertically on the monitor during single-frame playback. This is useful when taking pictures with the camera held vertically. The images will automatically be displayed in the correct direction even if the camera is rotated.

1 MENU ▶ [] ▶ []

- When set to [ON], images shot vertically will be automatically rotated and displayed during playback. You can also press the [] button to rotate and display the image.
- The rotated image will be recorded on the card in that position.

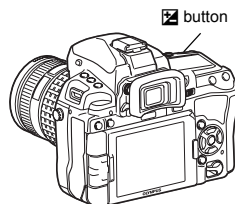

Original image before rotating

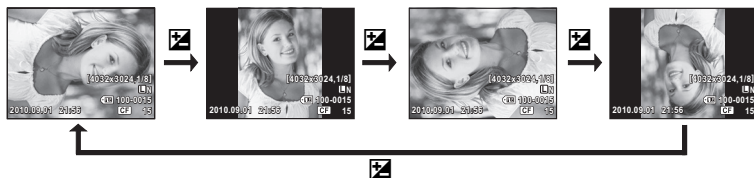

Playback on TV

Use the AV cable provided with the camera to play back recorded images on your TV.

- 1 Turn the camera and TV off, and connect the AV cable as illustrated.
- 2 Turn on the TV and set it to the video input mode. For details on switching to the video input mode, refer to the TV's manual.
- 3 Turn the camera on and press the [] (playback) button.

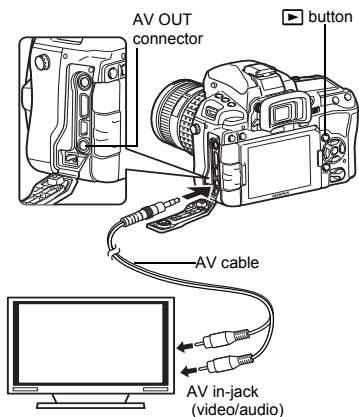

! Notes

- To connect the camera to a TV, use the provided AV cable.
- Make sure that the camera's video output signal type is the same as the TV's video signal type. (P. 108)
- The camera's monitor turns off automatically when the AV cable is connected to the camera.
- The image may appear off-center depending on the TV screen.

Connection via HDMI mini-cable

- Be sure to turn off the camera and the TV before connecting the mini-cable.

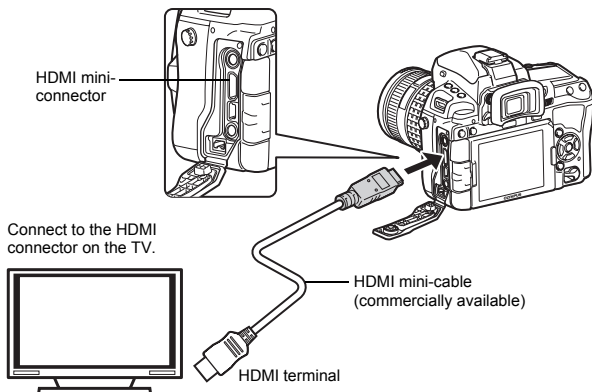

7

Playback functions

- 1 Connect the HDMI mini-cable to the HDMI connector of the TV.
- 2 Connect the HDMI mini-cable to the HDMI connector of the camera.
- 3 Turn on the TV and switch "INPUT" to "HDMI INPUT".
- 4 Turn on the camera.

! Notes

- For details on changing the input source of the TV, refer to the TV's instruction manual.
- Use an HDMI mini-cable that matches the HDMI mini connector on the camera and the HDMI connector on the TV.
- When the camera and TV are connected by both an AV cable and an HDMI mini-cable, HDMI will take priority.
- Depending on the TV's settings, the displayed images and information may become cropped.
- When you connect to a TV via an HDMI mini-cable, you can select the format of the digital video signal. "HDMI" (P. 108)
- You cannot shoot pictures or movies when the HDMI cable is connected.
- Do not connect the camera to other HDMI output devices. Doing so may damage the camera.
- HDMI output is not performed while connected via USB to a computer or printer.

Using the TV remote control

The camera can be operated by a TV remote control when connected to a TV that supports HDMI control.

1 MENU ▸ [%] ▸ [] ▸ [HDMI] ▸ [HDMI CONTROL]

- Set to [ON].

2 Operate the camera by using the TV remote control.

- You can operate the camera by following the operation guide displayed on the TV.
- During single-frame playback, you can display or hide the information display by pressing the [Red] button, and display or hide the index display by pressing the [Green] button.
- Some functions may be unavailable, even if displayed, depending on the TV.

Editing still images

Recorded images can be edited and saved as new images. Available editing functions depend on the image format (image record mode).

A JPEG file can be printed as is without modification. A RAW file, on the other hand cannot be printed as is. To print a RAW file, use the RAW edit function to convert the RAW data format to JPEG.

Editing images recorded in RAW data format

The camera performs image processing (such as white balance and sharpness adjustment) on images in the RAW data format, then saves the data to a new file in the JPEG format. While checking recorded images, you can edit them to your liking.

Image processing is performed based on the current camera settings. Change the camera settings to suit your preferences before editing.

Editing images recorded in JPEG data format

[SHADOW ADJ] Brightens a dark backlit subject.

[REDEYE FIX] Reduces the red-eye phenomenon during flash shooting.

[]
Set the trimming size with the main dial and the trimming position with the arrow pad.

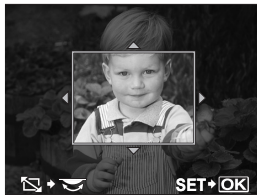

[ASPECT] Changes the aspect ratio of images from 4:3 (standard) to [3:2], [16:9], [6:6], [5:4], [7:6], [6:5], [7:5] or [3:4]. After changing the aspect ratio, use the arrow pad to specify the trimming position.

[BLACK & WHITE] Creates black and white images.

[SEPIA] Creates sepia-toned images.

[SATURATION] Sets the color depth. Adjust the color saturation checking the picture on the screen.

[] Converts the image file size to 1280 × 960, 640 × 480, or 320 × 240. Images with an aspect ratio other than 4:3 (standard) are converted to the closest image file size.

[e-PORTRAIT] Makes skin look smooth and translucent.

- You may not be able to compensate depending on the image if face detection fails.
- The size of the compensated image is limited to [M] (2560 × 1920) or smaller.

1 MENU ▸ [] ▸ [EDIT] ▸ [SEL. IMAGE (Select Image)]

- Selection is also possible during playback by pressing the button.

2 Use to select an image, then press the button.

- The camera recognizes the image data format.
- For images recorded in JPEG+RAW, a selection screen will appear, asking you which data to edit.

3 The setting screen varies with the image data format. Select the item you want to edit and do the following steps.

Confirm the data format from here.

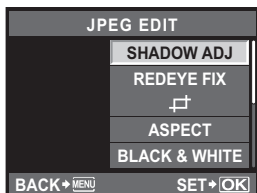
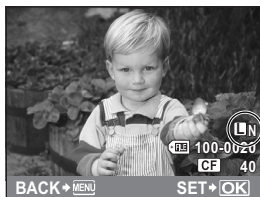

- The edited image is saved as another image, apart from the original image.
- To exit the edit mode, press the **MENU** button.

7

Playback functions

! Notes

- Red-eye correction may not work depending on the image. Red-eye correction may affect other parts of the image, as well as the eyes.
- Editing of a JPEG image is not possible in the following cases:
 - When an image is recorded in RAW, when an image is processed on a PC, when there is not enough space in the card memory, when an image is recorded on another camera.
- When resizing () an image, you cannot select a larger number of pixels than was originally recorded.
- [] and [ASPECT] can only be used to edit images with an aspect ratio of 4:3 (standard).

Adding sound to still pictures

Add an audio recording (up to 30 sec. long) to the current photograph.

1 MENU ▸ [] ▸ [EDIT] ▸ [SEL. IMAGE] ▸ []

- Selection is also possible during playback by pressing the button.

2 Select using , then press the button.











- [NO] : No sound is recorded.
- [START] : Audio recording starts.
- [YES] : Erases added sound.

! Notes

- You cannot record sound for protected images.
- To stop recording part-way through, press the button.

Image overlay

Up to 4 frames of RAW images taken with the camera can be overlaid and saved as a separate image. The image is saved with the record mode set at the time the image is saved.

- 1 MENU** ▶ [▶] ▶ [EDIT] ▶ [IMAGE OVERLAY]
 - Selection is also possible during playback by pressing the  button.
- 2 Select the number of frames to overlay and press the  button.**
- 3 Use  to select a frame and press the  button.**
 - Repeatedly select images only for the number of frames selected in Step 2.
 - To cancel your selection, press the  button again.
- 4 Use  to select an image, then use  to select the gain for each image. Press the  button.**
 - Select from 0.1 to 2.0.
 - The displayed image changes as the gain is adjusted.
- 5 Use  to select [YES], then press the  button.**

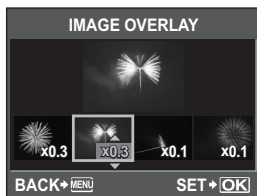

TIPS

To overlay 5 or more frames:

→ To overlay 5 or more frames, save the overlay image as a RAW file and use [IMAGE OVERLAY] repeatedly.

! Notes

- When the record mode is set to [RAW], the overlay image is saved as [LN+RAW].
- When the picture mode is set to [A_{PT}] to [A_{VL}], the overlay image is saved with [3 NATURAL].

This function lets you copy images to and from the SD card and CompactFlash. This menu can be selected if both cards are inserted. The selected card is the copying source. "CF"/ "SD" (P. 116)

Single-frame copy

- 1 Play back the image you want to copy and press the **COPY/** button.
- 2 Use to select [YES], then press the button.

COPY/ button

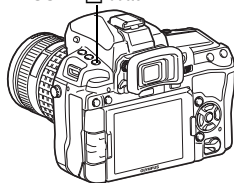

Copying selected frames

This function lets you select multiple images and copy them at the same time during index display.

- 1 Select the image to copy on the index display, then press the button.
 - The selected images will be shown with .
 - To cancel your selection, press the button again.
- 2 After you have selected the images to copy, press the **COPY/** button.
- 3 Use to select [YES], then press the button.

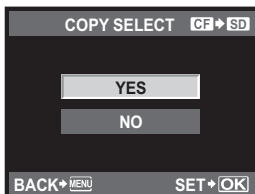

Copying all the frames

- 1 **MENU** [COPY ALL]
- 2 Press .
- 3 Use to select [YES], then press the button.



Protect images you do not want to erase. Protected images cannot be erased by the single-frame or all-frame erase function.

Single-frame protect

Play back the image you want to protect and press the button.

- (protect mark) is displayed on the top right corner of the screen.

To cancel the protection

Display the images that are protected and press the button.

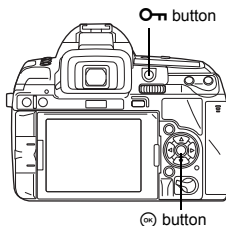

Protecting selected frames

This function lets you select multiple images and protect them at the same time during index display.

- 1 Display the images you want to protect and press the button.
 - The selected images will be shown with .
 - To cancel your selection, press the button again.
 - Press to select the images you want to protect and press the button.
- 2 After you have selected the images to protect, press the button.

Canceling all protections

This function lets you cancel the protection of several images at one time.

- 1 MENU ▸ ▸ [RESET PROTECT]
- 2 Use to select [YES], then press the button.

Notes

- Formatting the card erases all images even if they have been protected.
 - "Formatting the card" (P. 136)
- Protected images cannot be rotated even when the button is pressed.



Lets you erase recorded images. You can select single-frame erase, which erases only the currently displayed image; all-frame erase, which erases all the images stored on the card; or selected frame erase, which erases only the frames selected.

! Notes

- When you perform all-frame or selected frame erase on images recorded using RAW+JPEG, both the RAW and JPEG images are erased. When using single-frame erase, you can select whether to erase the JPEG, RAW, or both RAW and JPEG images. "RAW+JPEG ERASE" (P. 115)
- Protected images cannot be erased. Cancel protected images, then erase them.
- Once erased, images cannot be restored. "Protecting images" (P. 97)

Single-frame erase

- 1 Display the images you want to erase and press the button.
- 2 Use to select [YES], then press the button.

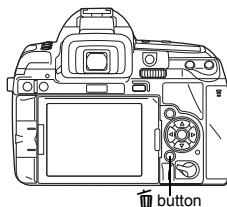

button

7

Erasing selected frames

This function lets you erase selected images at one time during single-frame playback or index display.

- 1 Display the images you want to erase and press the button.
 - The selected images will be shown with .
 - To cancel your selection, press the button again.
 - Press to select the images you want to erase and press the button.
- 2 After you have selected the images to erase, press the button.
- 3 Use to select [YES], then press the button.

All-frame erase

- 1 MENU \blacktriangleright \blacktriangleright [CARD SETUP]
- 2 Use to select [ALL ERASE], then press the button.
- 3 Use to select [YES], then press the button.
 - All frames will be erased.

TIPS

To erase immediately:

- If you have set "QUICK ERASE" (P. 115) to [ON], pressing the button will erase an image immediately.
- You can set the initial position of the cursor to [YES]. "PRIORITY SET" (P. 116)

Setup Menu

Use the Setup Menu to set the basic camera functions. For details on using the menu lists, see "Setting on the menu" (P. 22).

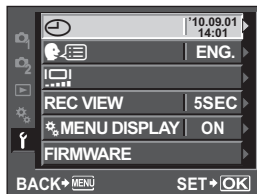

(Date/time setting)

P. 14

(Changing the display language)

You can change the language used for the on-screen display and error messages from ENGLISH to another language.

(Monitor brightness adjustment)

You can adjust the brightness and color temperature of the monitor.

Use to switch between (color temperature) and (brightness), and use to adjust the value between [+7] to [-7].

Setting to **[AUTO BRIGHTNESS]** allows the illumination sensor to measure the surrounding brightness and automatically get the monitor darker for optimal viewing.

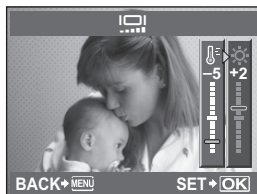

REC VIEW

You can display the picture you have just taken on the monitor while it is being recorded to the card, and to select how long the picture is displayed. This is useful for making a brief check of the picture you have just taken. Pressing the shutter button halfway while checking the picture lets you resume shooting immediately.

[1SEC] to [20SEC] Selects the number of seconds to display each picture. Can be set in units of 1 second.

[OFF] The picture being recorded to the card is not displayed.

[AUTO Displays the image being recorded, and then switches to playback mode. This is useful for erasing a picture after checking it.

MENU DISPLAY

[OFF] The custom menu is hidden on the menu screen.

[ON] The custom menu is shown on the menu screen.

Your product's firmware version will be displayed.

When you make inquiries about your camera or accessories or when you want to download software, you will need to state which version of each of the products you are using.

RESET/MYSET

Setting MYSET

You can register the current camera setting condition as up to 4 MYSETs.

Set the camera to desired condition and then register it.

By registering it, you can select it as one of the shooting mode such as **P/S/A/M**.

Also, you can assign it to the specified button (**[Fn]**/**[••]**/**Ⓢ** (Preview)) in **[BUTTON FUNCTION]**. "BUTTON FUNCTION" (P. 106)

Registering MYSET

Menu

MENU > **[Q]** > **[RESET/MYSET]**

- 1) Select between **[MYSET1]** to **[MYSET4]** and press the button.
- 2) Use to select **[SET]**, then press the button.
 - The current settings are registered in the camera. For details on the functions that can be registered to MYSET, refer to "Functions that can be registered with MYSET setting" (P. 145).
 - To cancel the registration, select **[RESET]**.

Using the MYSET as a shooting mode

Direct button

MODE +

Select the desired MYSET.

- Assign MYSET1 to MYSET4 to the **Fn** button ("BUTTON FUNCTION" (P. 106)) to use the short-cut MYSET shooting.
Shoot while holding the **Fn** button.





Notes

- MYSET (My Setting)

Changing each setting to MYSET setting while remaining the current shooting mode

Menu

MENU ▸ [P] ▸ [RESET/MYSET]

- 1) Select between [MYSET1] to [MYSET4] and press the  button.
- 2) Use   to select [YES], then press the  button.
 - Each setting is set to the MYSET setting excluding some items such as P/S/A/M. For details on the functions that cannot be changed, refer to “Functions that can be registered with MYSET setting” ( P. 145).

Resetting the settings

In this camera, the changed settings are retained when the power is turned OFF. To reset the settings, execute [RESET].

- Some settings are not reset.

Reset operation





Direct button

ISO + 

- Press and hold two seconds or more to display the menu. Use  main dial to select.

Menu

MENU ▸ [P] ▸ [RESET/MYSET]

- 1 Select [RESET], then press the  button.
- 2 Use   to select [YES], then press the  button.

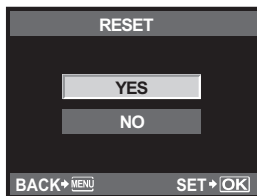

Use the Custom Menu to customize the shooting functions.

Custom Menu has 10 tabs (P. 102 to P. 117) that are divided according to the functions to be set.

	AF/MF	(P. 102)		CUSTOM	(P. 112)
	BUTTON/DIAL	(P. 104)		ASPECT/COLOR/WB	(P. 113)
	RELEASE/	(P. 108)		RECORD/ERASE	(P. 115)
	DISP/PC	(P. 108)		MOVIE	(P. 117)
	EXP/ISO	(P. 111)		UTILITY	(P. 117)

For details on using the menu lists, see "Setting on the menu" (P. 22).

Custom Menu ▶ AF/MF

AF AREA

P. 53

Select the AF target mode.

[.] SET UP

Selects the operation of the dials or arrow pad when selecting the AF target.

- [OFF]** Stops after moving to the AF target on the end.
- [LOOP]** After moving to the AF target on the end, moves to the AF target on the opposite end of the same row or column. Selects all AF targets before moving to the AF target on the opposite end, and **[AF AREA]** is set to [:].
- [SPIRAL]** After moving to the AF target on the end, moves to the AF target on the opposite end of the next row or column. Selects all AF targets before moving to the AF target on the opposite end, and **[AF AREA]** is set to [:].

e.g.) When moving from the top left AF target to the right

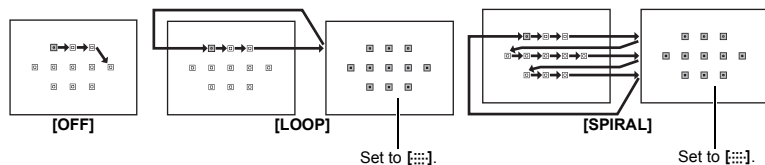

RESET LENS

When set to **[ON]**, this resets the focus of the lens (infinity) each time the power is turned off.

BULB FOCUSING

You can set the camera to enable focus adjustments during bulb shooting with MF.

- [ON]** During exposure, you can turn the focus ring and adjust the focus.
- [OFF]** The focus is locked during exposure.

FOCUS RING

You can customize how the lens adjusts to the focal point by selecting the rotational direction of the focus ring. It is not applied for the mechanically-focus lenses such as Olympus SWD lenses.

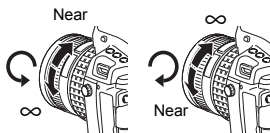

MF ASSIST

Set it to **[ON]** to automatically enlarge the subject on the monitor by rotating the focus ring while shooting in **[S-AF+MF]** or **[MF]** with live view.

[.]SET HOME

You can register the AF target mode and the AF target position that you use frequently as home position. Assign **[.]SET HOME** to the specified button in **[BUTTON FUNCTION]** in advance to use the registered home position quickly during shooting. "BUTTON FUNCTION" (P. 106)

PD AFL

Set it to **[ON]** to perform phase difference AF (AF with the mirror lowered) by pressing AEL/AFL button while shooting with live view.

AF ILLUMINAT. (AF Illuminator)

The built-in flash can be set to function as an AF illuminator. This makes focusing easier in low-light conditions using AF mode. To use this function, raise the flash. It is available when shooting with the phase difference AF (when shooting using the view finder).

C-AF LOCK

When set to **[ON]**, during focusing with C-AF mode, this prevents the focus from changing even if the distance to the subject suddenly changes. This is effective when shooting at a location where something passes in front of or behind the subject. It is available when shooting using the view finder.

AF AREA POINTER

When set to **[OFF]**, the AF target does not light when the subject is in focus.

AF SENSITIVITY

You can set the range of the AF target for focusing when **[AF AREA]** is set to **[·]**. It is available when shooting with the phase difference AF (when shooting using the view finder).

[NORMAL] The camera focuses using a range that is somewhat larger than the selected AF target.

[SMALL] The camera focuses only within the selected AF target. When **[SMALL]** is selected, the setting display for **[AF AREA]** becomes **[·]s**.

DIAL FUNCTION

In **P**, **A**, **S**, or **M** mode, you can assign functions other than the default functions to the main dial and sub dial. You can also switch the operations of the main dial and sub dial for menu and playback operations with the default operations.

- P** : [Ps]/[]/[]
A : [FNo.]/[]/[]
S : [SHUTTER]/[]/[]
M : [SHUTTER]/[FNo.]
MENU : []/[/ VALUE]
 : [PREV/NEXT]/[Q]

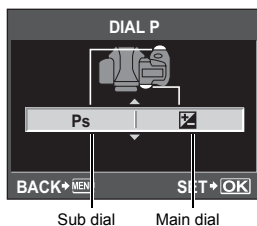

- [] on [MENU] means the horizontal operation of the dial (the same as pressing). [/ VALUE] means the vertical operation of the dial (the same as pressing).

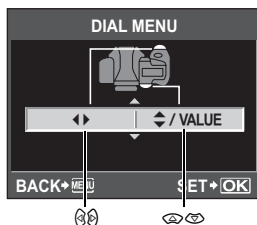
DIAL DIRECTION

You can select the rotational direction of the dial and the direction in which the shutter speed/aperture value will increase or decrease.

Setting	(rotational direction of the dial)	(rotational direction of the dial)
DIAL1	<ul style="list-style-type: none"> • Slower shutter speed • Open the aperture (f-number is decreased) 	<ul style="list-style-type: none"> • Faster shutter speed • Close the aperture (f-number is increased)
DIAL2	<ul style="list-style-type: none"> • Faster shutter speed • Close the aperture (f-number is increased) 	<ul style="list-style-type: none"> • Slower shutter speed • Open the aperture (f-number is decreased)

AEL/AFL

You can use the **AEL/AFL** button to perform AF or metering operations instead of using the shutter button.

Select the function of the button to match the operation when the shutter button is pressed. Select **[mode1]** to **[mode4]** in each focus mode. (You can only select **[mode4]** in C-AF mode.)

Mode	Shutter button function				AEL/AFL button function	
	Half-press		Full press			
	Focus	Exposure	Focus	Exposure	Focus	Exposure
[S-AF]						
mode1	S-AF	Locked	—	—	—	Locked
mode2	S-AF	—	—	Locked	—	Locked
mode3	—	Locked	—	—	S-AF	—
[C-AF]						
mode1	C-AF start	Locked	Locked	—	—	Locked
mode2	C-AF start	—	Locked	Locked	—	Locked
mode3	—	Locked	Locked	—	C-AF start	—
mode4	—	—	Locked	Locked	C-AF start	—
[MF]						
mode1	—	Locked	—	—	—	Locked
mode2	—	—	—	Locked	—	Locked
mode3	—	Locked	—	—	S-AF	—

Basic operations

- [mode1]** For determining the metered exposure while focusing. AE lock is activated while pressing the **AEL/AFL** button, allowing you to adjust the focus and determine the exposure separately.
- [mode2]** For determining the exposure when you press the shutter button fully. This is useful for shooting scenes with significant changes in lighting, such as on a stage.
- [mode3]** For focusing with the **AEL/AFL** button instead of the shutter button.
- [mode4]** Press the **AEL/AFL** button to focus, and press the shutter button fully to determine the exposure.

Using phase difference AF during live view

Setting **[PD AFL]** to **[ON]** in **[M]** allows to use the phase difference AF during live view.

Mode	Shutter button function				AEL/AFL button function	
	Half-press		Full press			
	Focus	Exposure	Focus	Exposure	Focus	Exposure
[S-AF]						
mode1	S-AF	Locked	—	—	PD AF	—
mode2	S-AF	—	—	Locked	PD AF	—
mode3	—	Locked	—	—	PD AF	—
[MF]						
mode1	—	Locked	—	—	—	Locked
mode2	—	—	—	Locked	—	Locked
mode3	—	Locked	—	—	PD AF	—











You can lock and maintain the exposure by pressing the **AEL/AFL** button.





[ON] Press the **AEL/AFL** button to lock and maintain the exposure. Press again to cancel the maintaining of the exposure.

[OFF] The exposure will be locked only while the **AEL/AFL** button is pressed.

BUTTON FUNCTION

You can assign the following functions to each button; the **Fn** button, **[...]** button and the  (preview) button.

Function	Detail	Button to assign		
		Fn	[...]	 (preview)
[Fn FACE DETECT]	Press the button to set  FACE DETECT to [ON] . Press again to set it to [OFF] .  "Using the face detection function" (P. 38), "  FACE DETECT " (P. 109)	✓	—	✓
[PREVIEW]	While holding the button, you can use the preview function.  "Preview function" (P. 46)	✓	✓	✓
[LIVE PREVIEW]	Pressing the button automatically switches the camera to live view for a preview of the picture on the monitor.	✓	—	✓
	Press the button to acquire the WB value.  "Setting the auto/preset/custom white balance" (P. 67)	✓	✓	✓
[...] HOME	Press the button to switch to the registered AF home position. Press the button again to switch to the original AF target mode. If you turn off the camera while it is set to the AF home position, the original position will not be stored.  "Registering an AF target mode" (P. 58)	✓	✓	✓
[MF]	Press the button to switch AF mode to [MF] . Press the button again to switch to the original AF mode.	✓	✓	✓
[RAW 	Press the button to switch from JPEG to JPEG+RAW or from JPEG+RAW to JPEG for the record mode. You can change the record mode by turning the dial while holding down the button.	✓	✓	✓
[P/A/S/M]	You can switch the shooting mode by rotating the dial while holding down the button.	✓	✓	✓
[TEST PICTURE]	Pressing the shutter button while pressing the button enables you to check the picture you have just taken on the monitor without having to record the picture to the card. This is useful when you want to see how a picture turned out without saving it.	✓	✓	✓
[MYSET1]/ [MYSET2]/ [MYSET3]/ [MYSET4]	While holding the button, you can take pictures using the camera settings registered in [RESET/MYSET] .  "Setting MYSET" (P. 100)	✓	✓	✓

Function	Detail	Button to assign		
		Fn	[***]	 (preview)
 (Underwater wide/ Underwater macro)	You can switch the shooting mode to  by pressing the button. Press and hold the button to return to the previous shooting mode.	✓	—	—
[LEVEL GAUGE]	Press the button to display the level gauge in the viewfinder and on the control panel, and press it again to hide the level gauge display.  "LEVEL GAUGE" (P. 110)	✓	✓	✓
[MAGNIFY]	Press the button to display the subject enlarged on the monitor.	✓	—	✓
[AF AREA SELECT]	You can select the AF target by rotating the dial while holding down the button.	✓	✓	✓
[IS MODE (I.S.)]	You can set the image stabilizer by rotating the dial while holding down the button.  "Image stabilizer" (P. 62)	✓	✓	✓
[OFF]	Does not allow function allocation.	✓	✓	✓

✓ :Available to assign — :Cannot assign

FUNCTION:

When selecting , you can use the arrow pad to select the position of the AF target. You can perform this operation for several seconds after pressing the shutter button halfway and then releasing it.

Notes

- During live view, the  button operation is exclusive to the movie button regardless of the setting.
- The same function cannot be assigned to multiple buttons.
- The functions that cannot be assigned are not displayed on the function selection screen.





BUTTON TIMER

The direct button may remain selected even after it is released.

[OFF] Available only when the button is pressed.

[3SEC]/[5SEC]/[8SEC] The button remains selected during the number of seconds indicated.

[HOLD] The button remains selected until you press it again.

- Buttons that can be set with [BUTTON TIMER]
ISO, , **WB**, , , **AF**, , , **MODE**



You can switch the functions of the **AEL/AFL** button and the **Fn** button. When you select **[ON]**, the **AEL/AFL** button will function as the **Fn** button, and the **Fn** button will function as the **AEL/AFL** button.

- The setting also applies to the **Fn** button on the optional power battery holder when attached to the camera.

RLS PRIORITY S/RLS PRIORITY C

Normally, this camera does not release the shutter while the AF is operating or the flash is charging. If you want to release the shutter without waiting until these operations have completed, use the setting below. You can set the release priority individually in AF mode.

RLS PRIORITY S Sets release priority for S-AF mode P. 53.

RLS PRIORITY C Sets release priority for C-AF mode P. 54.

L fps

You can set the number of pictures shot in one second when using sequential shooting with [L] from [1fps] to [4fps].

Custom Menu ▶ DISP//PC

HDMI

Set this when the camera is connected to a TV via an HDMI mini-cable.

HDMI OUT

Selecting the digital video signal format for connecting to a TV via an HDMI mini-cable.

[1080i] Play back in 1080i format.

[720p] Play back in 720p format.

[480p/576p] Play back in 480p/576p format (when [VIDEO OUT] is set to [PAL], play back in 576p format).

Notes

- When set to [1080i], 1080i format takes priority for HDMI output. However, if this setting does not match the input setting of the TV, the resolution is changed first to 720p and then to 480p. For details on changing the input setting of the TV, refer to the TV's instruction manual.

HDMI CONTROL

When [ON] is selected, the camera can be operated by a TV remote control when it is connected to the TV via an HDMI mini-cable.

VIDEO OUT

You can select NTSC or PAL according to your TV's video signal type.

You will need to set this when you want to connect the camera to a TV and play back images in a foreign country. Make sure the correct video signal type is selected before connecting the video cable. If you use the wrong video signal type, recorded pictures will not play back properly on your TV.

TV video signal types in major countries and regions

Check the video signal type before connecting the camera to your TV.

NTSC	North America, Japan, Taiwan, Korea
PAL	European countries, China

SLEEP

The camera will enter sleep (standby) mode to reduce the drain on the battery if no operations are performed for the specified period. [OFF] cancels the sleep mode. Pressing a button such as the shutter button reactivates the camera.

LIVE VIEW BOOST

During live view shooting, you can brighten the monitor for easier confirmation on the subject.

[OFF]

The subject is displayed on the monitor with the brightness level that is adjusted according to the exposure being set. You can shoot while confirming through the monitor in advance to get a picture that is to your liking.

[ON]

The camera automatically adjusts the brightness level and displays the subject on the monitor for easier confirmation. The effect of the exposure compensation adjustments will not be reflected on the monitor.

☺ FACE DETECT

When set to [ON], the camera will detect people's faces and automatically adjust the focus there. "Using the face detection function" (P. 38)

You can play back close-up images focusing on the subject's face. "Single-frame/Close-up playback" (P. 86)

📷/INFO SETTINGS

Select the information displayed when the **INFO** button is pressed during live view or playback.

INFO Sets whether to display or hide [IMAGE ONLY], [OVERALL], , [HIGHLIGHT&SHADOW] during playback. "Information display" (P. 89)

[LV-INFO] Sets whether to display or hide , [HIGHLIGHT&SHADOW], [ZOOM], [MULTI VIEW], [IMAGE ONLY], , , , or during live view. "Switching the information display" (P. 39)

SETTINGS Set whether to display or hide 4/[9]/[25]/[100]/[CALENDAR] during index display/calendar display. "Index display/Calendar display" (P. 88)

📷 CONTROL SETTINGS

Set whether to display/hide the live control (P. 37) super control panel (P. 6) during live view.

HISTOGRAM SETTINGS

Set the brightness range of the highlights (overexposed) and shadows (underexposed) to display warning on the Highlight&Shadow playback.

BACKLIT LCD (Backlight timer)

To save battery power, after the super control panel is displayed for a specified period of time, the monitor backlight darkens. Select from [8SEC], [30SEC], or [1MIN] for the time until the backlight get darker. [HOLD] sets the backlight not to get darker.

The monitor backlight turns on again as soon as you touch any button (the shutter button, arrow pad, etc.).

■))

You can turn off the beep sound that is emitted when the focus locks by pressing the shutter button.

VOLUME

You can adjust the speaker volume.

USB MODE

You can connect the camera directly to a computer or printer with the provided USB cable. If you specify the device you are connecting to beforehand, you can skip the USB connection setting procedure normally required every time you connect the cable to the camera. For details on how to connect the camera to either device, refer to "Connecting the camera to a printer" (P. 124) and "Using the OLYMPUS Viewer 2 / [ib]" (P. 127).

[AUTO]

The selection screen for the USB connection will be displayed every time you connect the cable to a computer or printer.

[STORAGE]

Allows you to transfer images to a computer. Also, select to use the OLYMPUS Viewer 2 / [ib] software via PC connection.

[MTP]

Allows you to transfer images to a computer running Windows Vista without using the OLYMPUS Viewer 2 / [ib] software.

[PRINT]

Can be set when connecting the camera to a PictBridge-compatible printer.

[CONTROL]

Allows you to control the camera via the USB connection by using the Olympus Studio 2.

LEVEL GAUGE

This camera has an acceleration sensor that enables display of a bi-directional level gauge to detect tilting horizontally and in the forward and backward direction when [LEVEL GAUGE] is set to [ON]. Use this as a guide in situations where you cannot determine whether the camera is level, such as when you cannot see the horizon or skyline on the screen or when the screen is dark while shooting night scenes.

Viewfinder and control panel indications:

Press the shutter button halfway to display the level gauge in the viewfinder and on the control panel after a few seconds.

Viewfinder

Control panel

Horizontal level indicator

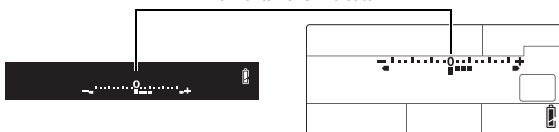

Monitor indication:

Press the **INFO** button repeatedly to display the level gauge. "Switching the information display" (P. 39)

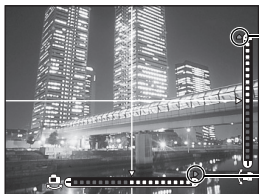



Displayed when outside the display range.

TIPS

To calibrate the level gauge:

→  "LEVEL ADJUST" (P. 120)

To easily turn on and off the level gauge:

→ By registering [**LEVEL GAUGE**] to the **Fn** button, [**•••**] button or  (preview) button, you can press the that button to display or hide the level gauge.  "BUTTON FUNCTION" (P. 106)

! Notes

- If the camera is tilted forward or backward to a large degree, the error of the horizontal tilting increases.

4 h TIMER (Auto power off)

You can set the camera to turn off automatically if not operated for 4 hours. It will not turn off if this is set to [**OFF**].

PICTURE MODE SETTINGS

When selecting the picture mode, you can skip the items that have not been set to [**ON**].

Custom Menu ▶ EXP//ISO

EV STEP

You can select the EV step for exposure parameter setting, such as shutter speed, aperture value, or exposure compensation value, from [**1/3EV**], [**1/2EV**], or [**1EV**].

METERING

 P. 46

Select the metering method.

AELMetering

You can set the metering mode when pressing the **AEL/AFL** button to lock the exposure.

- [**AUTO**] performs metering in the mode selected under [**METERING**].

ISO STEP

You can select the EV step of the ISO sensitivity from [**1/3EV**] or [**1EV**].

ISO-AUTO SET

You can set the upper limit and default ISO values when ISO is set to [**AUTO**].

[HIGH LIMIT]

This sets the upper limit of the ISO value that automatically changes. The upper limit can be set from 200 to 6400 in 1/3 EV increments.

[DEFAULT]

This sets the value to be normally used when the optimum exposure can be obtained. The value can be set from 200 to 6400 in 1/3 EV increments.

ISO-AUTO

You can set the shooting mode in which the ISO **[AUTO]** setting is activated.

[P/A/S]

The **[AUTO]** setting is activated in all shooting modes except **M** and **BULB** mode.

When **[AUTO]** is selected in **M** mode, ISO 200 is set.

[ALL]

The **[AUTO]** setting is activated for other than **BULB** mode. The ISO is automatically selected to obtain the optimal ISO even in **M** mode.

BULB TIMER

You can select the maximum time (in minutes) for bulb shooting.

ANTI-SHOCK [+]

You can select the interval between fully pressing the shutter button and releasing the shutter to be anywhere from 1/8 to 30 seconds.

This diminishes camera shake caused by vibrations. This feature is useful in situations such as microscope photography and astrophotography.

Notes

Anti-shock is added to the shooting functions individually (single-frame shooting, sequential shooting, self-timer shooting and remote control shooting).  “Sequential shooting” (P. 59)

Custom Menu ▶ **CUSTOM**

X-SYNC.

You can set the shutter speed that will be used when the flash fires. The speed can be set from 1/60 to 1/250 in 1/3 EV increments.

SLOW LIMIT

You can set the slow limit of the shutter speed that will be used when the flash fires. The speed can be set from 30 to 1/250 in 1/3 EV increments.

- When **[AUTO]** or **[REDEYE]** is set, the synchronous speed is limited to 1/30 second even when the slow limit is set to slower than 1/30 second.



When set to **[ON]**, it will be added to the exposure compensation value and flash intensity control will be performed.

NOISE REDUCT. (Noise Reduction)

This function reduces the noise that is generated during long exposures. When shooting night scenes, shutter speeds are slower and noise tends to appear in images. With **[NOISE REDUCT.]**, you can let the camera reduce noise automatically to produce clearer images. When set to **[AUTO]**, noise reduction will be activated only when the shutter speed is slow. When set to **[ON]**, noise reduction will always be activated.

When set to **[OFF]**



When set to **[ON]** or **[AUTO]**

- While noise reduction is activated, it takes about twice the usual time to take a picture.
- The noise-reduction process is activated after shooting.
- During processing the card access lamp blinks. You cannot take more pictures until the card access lamp turns off.

! Notes

- During sequential shooting, **[NOISE REDUCT.]** is **[OFF]** automatically.
- This function may not work effectively with some shooting conditions or subjects.

NOISE FILTER

You can select the noise processing level. Use **[STANDARD]** for general use. **[HIGH]** is recommended during high sensitivity shooting (High ISO).

WB

P. 66

Select the white balance to suit the light source. Other than custom white balance **[CWB]**, adjust in the A direction (red - blue) and G direction (green - reddish purple) within the range **[+7]** to **[-7]**.

ALL

You can apply the same compensation value to all the white balance modes at once.

[ALL SET] The same compensation value applies to all WB modes.

[ALL RESET] The WB compensation value settings applied to each WB mode are all cleared at once.

If you select **[ALL SET]**

1) Use to select the color direction.

Toward A: Amber-Blue/Toward G: Green-Magenta

2) Use to set the compensation value. "WB compensation" (P. 68)

Releasing the **AEL/AFL** button takes a sample image. You can check the white balance you have adjusted.

If you select **[ALL RESET]**

1) Use to select **[YES]**.

COLOR SPACE

You can select how colors are reproduced on the monitor or printer. The first character in image file names indicates the current color space.  "FILE NAME" (P. 116)

Pmdd0000.jpg	[sRGB]	Standardized color space for Windows.
├── P : sRGB	[Adobe RGB]	Color space that can be set with Adobe Photoshop.
	── _ : Adobe RGB	

SHADING COMP.

In some cases, the edges of the image may be shadowed due to the properties of the lens. The shading compensation function compensates by increasing brightness at the dark edge of the image. This function is especially useful when a wide-angle lens is used.

! Notes

- This function is not available when a teleconverter or an extension tube is attached to the camera.
- At higher ISO settings, noise in image edges may be conspicuous.

SET

You can combine 3 image sizes and 4 compression rates and register 4 combinations of image settings with [SET].

 "Selecting the record mode" (P. 64)

Register 4 different combinations of image settings.

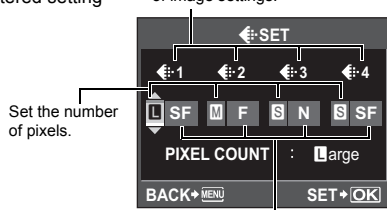

9

PIXEL COUNT

You can set the pixel size for the image size [M] and [S].

[Middle] Select [3200 × 2400], [2560 × 1920], or [1600 × 1200].

[Small] Select [1280 × 960], [1024 × 768], or [640 × 480].

ASPECT SHOOTING

When the aspect ratio for shooting is set to a setting other than **[4:3]**, select whether the setting is effective only when taking pictures using live view, or anytime when taking pictures using the viewfinder or live view.

[LV] The setting is only effective when taking pictures using live view.

[ALL] The setting is effective when taking pictures using the viewfinder or live view.

! Notes

- When taking pictures using the viewfinder, images are not trimmed and are recorded with the aspect ratio information at the time of shooting. During playback, images are displayed with a border based on the aspect ratio.
- The aspect border is not displayed in the viewfinder. When taking pictures using the viewfinder, refer to the diagram to the right.

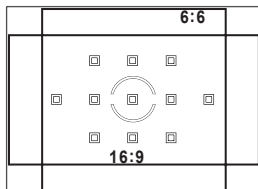



Viewfinder

Custom Menu ▶ RECORD/ERASE

QUICK ERASE

You can erase the picture you have just taken immediately using the  button.

[OFF] When the  button is pressed, the confirmation screen appears, asking you if you want to erase the picture.

[ON] Pressing the  button erases the picture immediately.

RAW+JPEG ERASE

You can select the method to erase images recorded in RAW+JPEG. This function can only be used to erase one frame.

[JPEG] Erases all JPEG image files, leaving only the RAW image files.

[RAW] Erases all RAW image files, leaving only the JPEG image files.

[RAW+JPEG] Erases both image file types.

! Notes

- This function is effective only if deleting one frame. For all-frame erase or erasing selected frames, both RAW and JPEG will be erased regardless of this setting.

FILE NAME

When you take a picture, the camera assigns it a unique file name and saves it in a folder. File names are assigned as shown in the illustration below.

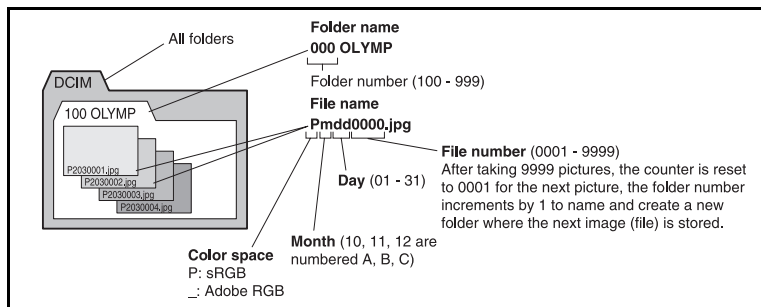

[AUTO]

Even when a new card is inserted, the folder numbers are retained from the previous card. If the new card contains an image file whose file number coincides with one saved on the previous card, the new card's file numbers start at the number following the highest number on the previous card.

[RESET]

When a new card is inserted, folder numbers start at 100 and file numbers start at 0001. If a card containing images is inserted, the file numbers start at the number following the highest file number on the card.

EDIT FILENAME

You can rename image files to make them easier to identify and organize.

The portion of the filename that can be changed depends on the color space. "COLOR SPACE" (P. 114)

sRGB : Pmdd0000.jpg

AdobeRGB : _mdd0000.jpg

You can change the character to OFF, A - Z or 0 - 9.

PRIORITY SET

You can customize the initial position of the cursor ([YES] or [NO]) on the Erasing images or Formatting the card screen.

dpi SETTING

You can set the resolution for printing images in advance. The set value is recorded on the card with the images.

[AUTO] Automatically set according to the image size.

[CUSTOM] You can make the desired setting. Press to display the setting screen.

[CF]/[SD]

You can select which card to use when both a CompactFlash and SD Card are loaded.

COPYRIGHT SETTINGS

You can add the artist/copyright name that are set in advance to the image as Exif data. For the artist name and the copyright name, you can enter up to 63 single-byte characters.

- If you edit the image, the names of the artist and the copyright are taken over to the created file. However, in the case of "playback + multiple" and "image overlay", the information is not taken over but becomes blank.
- We do not take any responsibility for any troubles or damages resulting from the use of the copyright information. Use this function for your own risk.

[COPYRIGHT INFO.] By setting to **[ON]**, you can add the artist/copyright name that are set in advance to the image as Exif data.

Set to **[OFF]** not to add the registered name.

[ARTIST NAME]

Enter the artist name.

[COPYRIGHT NAME]

Enter the copyright name.

Entering characters

- Press or turn the dial to select a character to enter from **(2)** field, then press the button.
- The selected character is displayed on the **(1)** field.
- Repeat this operation to enter whole name and select **[END]**, then press the button. The entered item is confirmed.
- The cursor moves between **(1)** and **(2)** by pressing the **INFO** button.



Custom Menu ▶ MOVIE

MOVIE

P. 84

Choose **[OFF]** to record silent movies.

Custom Menu ▶ UTILITY

PIXEL MAPPING

P. 135

EXPOSURE SHIFT

You can adjust the default value for optimal exposure for each metering mode according to your preference. This can be set in 1/6 EV increments ranging from -1.0 EV to +1.0 EV.

Notes

- The exposure compensation can be set from -5.0 EV to +5.0 EV. Setting **[EXPOSURE SHIFT]** reduces the range of the direction in which the default value is adjusted.
- You cannot check the exposure shift value during shooting. To make normal adjustments to the exposure, perform exposure compensation. "Exposure compensation" (P. 47)

CLEANING MODE

P. 135

EXT. WB DETECT

You can disable the white balance sensor used to determine the light source during auto white balance. This is useful when the light source near the sensor and the light source illuminating the subject are different.

AF FOCUS ADJ.

You can use the AF sensor to fine-adjust the focusing position to a range of ± 20 steps (-: closer, +: toward ∞). Normally, there is no need to change this.

[SET AF DATA]

Fine-adjust the AF default value and register the setting. You can also register the setting according to the lens.

[OFF]

AF focus adjustment is not performed.

[DEFAULT DATA]

Registers and applies all lens AF adjustment values not registered individually.

[LENS DATA]

Fine-adjusts the AF for each lens. You register the adjustment values for up to 20 lenses.

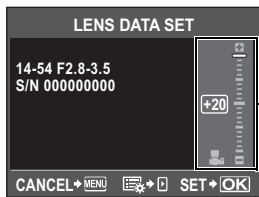

Use to adjust.

! Notes

- Depending on the adjustment made, the lens may not focus toward the ∞ or near side.
- When using a teleconverter, the teleconverter and lens are registered as a set.
- Only Four Thirds lenses can be registered.

[DATA LIST]

This displays the lens information registered with [LENS DATA] from [SET AF DATA]. Select a lens from the list, and then check, delete, or edit the registration information.

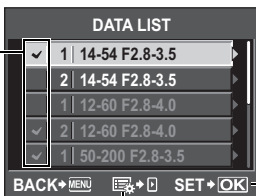

When the same lens is registered multiple times, the adjustment value for the lens with is applied.

Select this to check, delete, or edit the selected lens.

Select which lens to use when the same lens is registered multiple times.

TIPS

To take pictures while slightly changing the AF adjustment value:

→ After fine-adjusting the adjustment value, press the shutter button and repeatedly take pictures before pressing the button.

Note the following when taking pictures to check the AF adjustment value.

- It is recommended that the record mode be set to a setting higher than **L**N when taking pictures.
- Be careful of camera shake, subject movement, and changes in the distance to the subject when taking pictures.
- It is recommended that you take a picture of a subject with strong contrast within approximately 3 m (9.8 ft.) in the actual shooting environment (lighting and temperature).
- Avoid taking pictures against backlight.

To compare the difference in adjustment values:

→ You can use light box display to compare adjustment values. The adjustment values are also displayed during light box display.  "Light box display" (P. 87)

To register two types of adjustment values (with the focal point of the lens in front of and behind the subject):

→ You can register multiple adjustment values for the same lens. Select the adjustment value to be applied during shooting with the [DATA LIST] screen.

To register two of the same type of lens individually:

→ You can individually register multiple numbers of the same type of lens.





To specify and register AF targets, or to register the adjustment values for the wide and telephoto directions of the zoom:

→ On the [LENS DATA SET] screen, press  to make the following settings.

- You can specify individual AF targets and adjust each AF target. Normally, the adjustment values for all AF targets are registered.
- You can register different adjustment values for the wide and telephoto directions of the zoom. Normally, the adjustment value for the telephoto direction is registered.

AA BATTERY TYPE



The characteristics of AA batteries may differ depending on the battery type and brand. When using the optional power battery holder (HLD-4) with AA batteries, you can set the battery voltage level of the battery check display according to the battery characteristics. Normally, there is no need to change this.

- [1] This is the standard setting for battery characteristics of AA alkaline batteries.
- [2] The warning level is set lower than that of [1].
- [3] The warning level is set lower than that of [2].

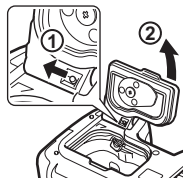
- To attach the power battery holder to the camera, remove the camera's battery cover, as shown in the diagram to the right.





! Notes

- Depending on the status of the batteries being used, this function may not work properly.
- The number of pictures that can be taken increases in the order of [1] [2] [3]; however, no more pictures may be able to be taken without a warning display.

WARNING LEVEL

You can change the timing when  is displayed (lights up). Normally, there is no need to change this.

Notes

- The battery check display is not a warning that the battery needs to be charged. When  blinks, charge the battery.  "Power on" (P. 13)

LEVEL ADJUST

You can calibrate the level gauge if you feel that the gauge is not level.

[RESET] Resets to the factory default adjustment value.

[ADJUST] Sets the current camera position as the zero point.

Notes

- Set **[ADJUST]** only when the camera is secured in a horizontal position. If the camera is not in a stable position, you may not be able to calibrate the level gauge as desired.

Print reservation (DPOF)



Print reservation

Print reservation allows you to save printing data (the number of prints and the date/time information) with the pictures stored on the card.

Pictures set with print reservation can be printed using the following methods.

DPOF (Digital Print Order Format)

This is for saving desired print settings on digital cameras. By entering which images to print and the number of copies of each, the user can easily have the desired images printed by a printer or print lab that supports the DPOF format.

Printing using a DPOF-compatible photo lab

You can print the pictures using the print reservation data.

Printing using a DPOF-compatible printer

Pictures can be printed directly from a dedicated printer without using a PC. For more details, refer to the printer's manual. A PC card adapter may also be necessary.

! Notes

- DPOF reservations set by another device cannot be changed by this camera. Make changes using the original device. Moreover, setting new DPOF reservations using this camera will erase the previous reservations set by another device.
- Not all functions may be available on all printers or at all photo labs.
- RAW data are not printable.

Single-frame reservation

Follow the operation guide to set print reservation for a picture.

1 MENU ▸ [▶] ▸ [🖨️]

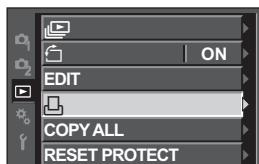

Operation guide —

2 Select [🖨️] and press the [OK] button.

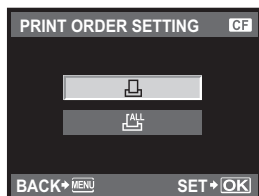

3 Press to select the frame that you want to set as print reservation, then press to set the number of prints.

- To set print reservation for several pictures, repeat this step.

4 Press the button when you have finished.

- The menu screen for single-frame reservation appears.

5 Select the date and time format and press the button.

- [NO] The pictures are printed without the date and time.
[DATE] The pictures are printed with the shooting date.
[TIME] The pictures are printed with the shooting time.

6 Select [SET] and press the button.

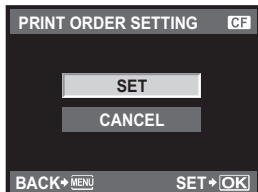
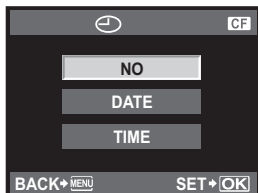

All-frame reservation

Applies print reservation to all the pictures stored in the card. The number of prints is fixed at 1.

1 MENU

2 Select and press the button.

3 Select the date and time format and press the button.

- [NO] The pictures are printed without the date and time.
[DATE] The pictures are printed with the shooting date.
[TIME] The pictures are printed with the shooting time.

4 Select [SET] and press the button.

Resetting the print reservation data

You can reset all print reservation data or just the data for selected pictures.

1 MENU ▸ [▶] ▸ [□]

Resetting the print reservation data for all pictures

- 2 Select [□] or [▶] and press the **OK** button.
- 3 Select [RESET] and press the **OK** button.



Resetting the print reservation data for a selected picture

- 2 Select [□] and press the **OK** button.
- 3 Select [KEEP] and press the **OK** button.
- 4 Use (◂) to select the frame with print reservation data you want to reset, then press (◃) to set the number of prints to 0.
- 5 Press the **OK** button when you have finished.
- 6 Select the date and time format and press the **OK** button.
 - This setting is applied to all frames with print reservation data.
- 7 Select [SET] and press the **OK** button.

Direct printing (PictBridge)



By connecting the camera to a PictBridge-compatible printer with the USB cable, you can print out recorded pictures directly. To find out if your printer is compatible with PictBridge, refer to the printer's manual.

PictBridge

The standard that enables digital cameras and printers made by different manufacturers to be connected, and also allows pictures to be printed directly from the camera.

STANDARD

All printers that support PictBridge have standard print settings. By selecting [STANDARD] on the settings screens (P. 125), you can print pictures according to these settings. For details on your printer's standard settings, refer to the printer's manual or contact the printer manufacturer.

- The available print modes and settings such as paper size vary with the type of printer. For details, refer to the printer's manual.
- For details on printing paper types, ink cassettes, etc., refer to the printer's manual.

Notes

- Use a fully charged battery.
- Images recorded in RAW data cannot be printed.
- The camera will not enter sleep mode while it is connected to the USB cable.

Connecting the camera to a printer

Use the provided USB cable to connect the camera to a PictBridge-compatible printer.

1 Turn the printer on and connect the camera's USB terminal to the printer's USB port with the USB cable.

- For details on how to turn the printer on and the position of the USB port, refer to the printer's manual.

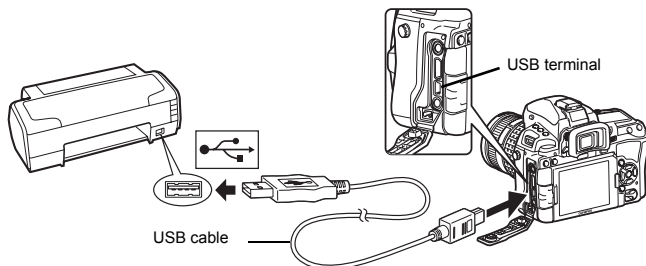

2 Turn on the camera.

- The selection screen for the USB connection is displayed.

3 Use \leftarrow \rightarrow to select [PRINT].

- [ONE MOMENT] is displayed and the camera and printer are connected.
Go to \leftarrow P. 125.

TIPS

When cannot be connected

→ Refer to "USB MODE" (\leftarrow P. 110)

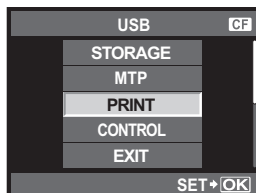

Easy printing

1 Use \leftarrow \rightarrow to display the pictures you want to print on the camera.

- Display the image you want to print on the camera and connect the camera with a printer using a USB cable. The screen on the right appears shortly.

2 Press the \leftarrow (print) button.

- The picture selection screen appears when printing is completed. To print another picture, use \leftarrow \rightarrow to select the image and press the \leftarrow button.
- To exit, unplug the USB cable from the camera while the picture selection screen is displayed.

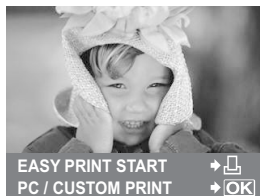

1 Follow the operation guide to set a print option.

Selecting the print mode

Select the type of printing (print mode). The available print modes are as shown below.

- [PRINT]** Prints selected pictures.
- [ALL PRINT]** Prints all the pictures stored in the card and makes one print for each picture.
- [MULTI PRINT]** Prints multiple copies of one image in separate frames on a single sheet.
- [ALL INDEX]** Prints an index of all the pictures stored in the card.
- [PRINT ORDER]** Prints according to the print reservation you made. If there is no picture with print reservation, this is not available. (P. 122)

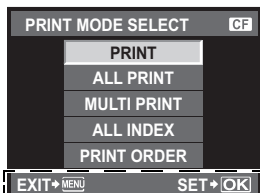

Follow the operation guide displayed here.

Setting the print paper items

This setting varies with the type of printer. If only the printer's STANDARD setting is available, you cannot change the setting.

- [SIZE]** Sets the paper size that the printer supports.
- [BORDERLESS]** Selects whether the picture is printed on the entire page or inside a blank frame.

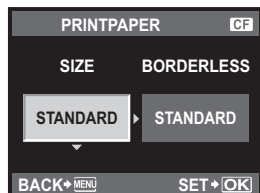

- [PICS/SHEET]** Selects the number of pictures per sheet. Displayed when you have selected **[MULTI PRINT]**.

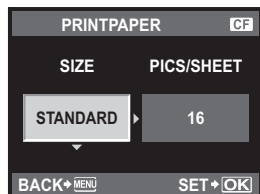

Selecting pictures you want to print

Select pictures you want to print. The selected pictures can be printed later (single-frame reservation) or the picture you are displaying can be printed right away.

- [PRINT] (OK)** Prints the currently displayed picture. If there is a picture that **[SINGLE PRINT]** reservation has already been applied to, only that reserved picture will be printed.
- [SINGLE PRINT] (A)** Applies print reservation to the currently displayed picture. If you want to apply reservation to other pictures after applying **[SINGLE PRINT]**, use (B) to select them.
- [MORE] (V)** Sets the number of prints and other items for the currently displayed picture, and whether or not to print it. For operation, refer to "Setting printing data" (P. 126) in the next section.



Setting printing data

Select whether to print printing data such as the date and time or file name on the picture when printing. When the print mode is set to **[ALL PRINT]** and **[OPTION SET]** is selected, the following screen appears.

- [*]** Sets the number of prints.
[DATE] Prints the date and time recorded on the picture.
[FILE NAME] Prints the file name recorded on the picture.
[Trims the picture for printing. Set the trimming size with the main dial and the trimming position with the arrow pad.

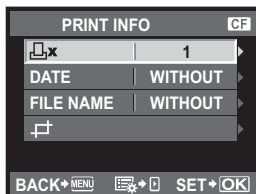

2 Once you have set the pictures for printing and printing data, select **[PRINT]**, then press the button.

- [PRINT]** Transfers images you print to the printer.
[CANCEL] Resets the settings. All print reservation data will be lost. If you want to keep the print reservation data and make other settings, press the **MENU** button. This returns you to the previous setting.

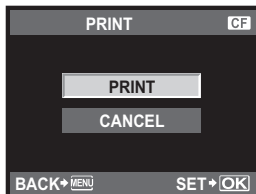

- To stop and cancel printing, press the button.

- [CONTINUE]** Continues printing.
[CANCEL] Cancels printing. All print reservation data will be lost.

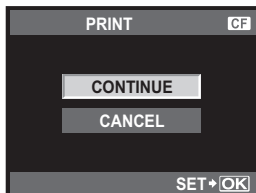

Windows

1 Insert the supplied CD in a CD-ROM drive.

Windows XP

- A "Setup" dialog will be displayed.

Windows Vista/Windows 7

- An Autorun dialog will be displayed. Click "OLYMPUS Setup" to display the "Setup" dialog.



! Notes

- If the "Setup" dialog is not displayed, select "My Computer" (Windows XP) or "Computer" (Windows Vista/Windows 7) from the start menu. Double-click the CD-ROM (OLYMPUS Setup) icon to open the "OLYMPUS Setup" window and then double-click "Launcher.exe".
- If a "User Account Control" dialog is displayed, click "Yes" or "Continue".

2 Follow the on-screen instructions on your computer.

! Notes

- If nothing is displayed on the camera screen even after connecting the camera to the computer, the battery may be exhausted. Use the battery fully charged.

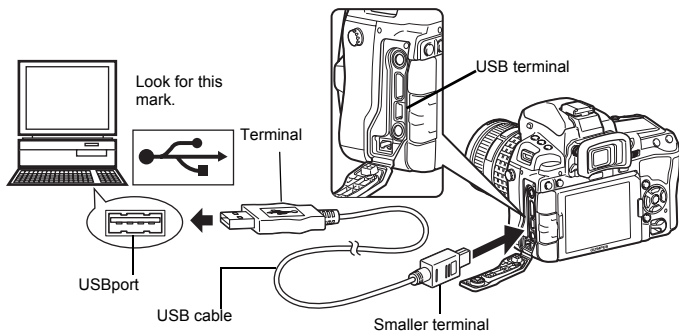

! Notes

- When you connect the camera to other device via USB, a screen to select the connection method is displayed. Set to **[STORAGE]**.

3 Register your Olympus product.

- Click the "Registration" button and follow the onscreen instructions.

4 Install OLYMPUS Viewer 2 and [ib] computer software.

- Check the system requirements before beginning installation.
- Click the "OLYMPUS Viewer 2" or "OLYMPUS ib" button and follow the on-screen instructions to install the software.

OLYMPUS Viewer 2	
Operating System	Windows XP (Service Pack 2 or later) / Windows Vista / Windows 7
Processor	Pentium 4 1.3GHz or better
RAM	1GB or more (2GB or more recommended)
Free Hard Drive Space	1GB or more
Monitor Settings	1024 x 768 pixels or more Minimum 65,536 colors (16,770,000 colors recommended)

[ib]	
Operating System	Windows XP (Service Pack 2 or later) / Windows Vista / Windows 7
Processor	Pentium 4 1.3GHz or better (Pentium D 3.0 GHz or better required for movies)
RAM	512MB or more (1GB or more recommended) (1 GB or more required for movies. 2 GB or more recommended)
Free Hard Drive Space	1GB or more
Monitor Settings	1024 x 768 pixels or more Minimum 65,536 colors (16,770,000 colors recommended)
Graphics	A minimum of 64 MB video RAM with DirectX 9 or later.

- *See online help for information on using the software.

Macintosh

1 Insert the supplied CD in a CD-ROM drive.

- When you insert the CD-ROM to Mac, the drive content is automatically displayed by the Finder. When it does not open automatically, double-click the icon on the desktop.
- Double-click the "Setup" icon to display the "Setup" dialog.

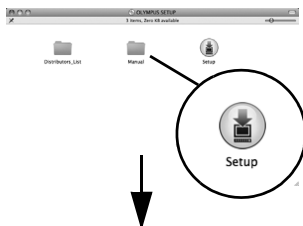

2 Install OLYMPUS Viewer 2.

- Check the system requirements before beginning installation.
- Click the "OLYMPUS Viewer 2" button and follow the on-screen instructions to install the software.



OLYMPUS Viewer 2	
Operating System	Mac OS X v10.4.11.v10.6
Processor	Intel Core Solo/Duo 1.5 GHz or better
RAM	1GB or more (2GB or more recommended)
Free Hard Drive Space	1GB or more
Monitor Settings	1024 x 768 pixels or more Minimum 32,000 colors (16,770,000 colors recommended)

*Other languages can be selected from the language combo box. For information on using the software, see online help.

Import and store the image without OLYMPUS Viewer 2 or [ib]

Your camera supports the USB Mass Storage Class. You can transfer images to a computer by connecting the camera to the computer with the provided USB cable. The following operating systems are compatible with the USB connection:
 Windows :Windows 2000 Professional/Windows XP Home Edition/Windows XP Professional/
 Windows Vista/Windows 7
 Macintosh :Mac OS X v10.3 or later

1 Turn the camera off and connect it to the computer.

- The location of the USB port varies with the computer. For details, refer to your computer's manual.

2 Turn on the camera.

- The selection screen for the USB connection is displayed.

3 Press to select [STORAGE]. Press the button.

4 The computer recognizes the camera as a new device.

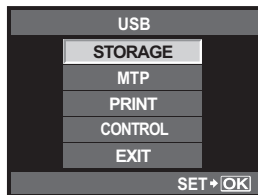

! Notes

- If your computer is running Windows Vista, select [MTP] in Step 3 to use Windows Photo Gallery.
- Data transfer is not guaranteed in the following environments, even if your computer is equipped with a USB port.
 - Computers with a USB port added by means of an extension card, etc.
 - Computers without a factory-installed OS and home-built computers
- When the camera is connected to the computer, none of the camera buttons are functional.

Shooting tips and information

The camera does not turn on even when a battery is loaded

The battery is not fully charged

- Charge the battery with the charger.

The battery is temporarily unable to function because of the cold

- Battery performance declines in low temperatures, and the charge may not be sufficient to turn on the camera. Remove the battery and warm it by putting it in your pocket for a while.

No picture is taken when the shutter button is pressed

The camera has turned off automatically

- To save battery power, if there is no operation, the camera goes into sleep mode after a fixed period of time and the camera stops operating. The camera activates again when you touch the shutter button or any other button. The camera will turn off automatically if there is no further operation for 4 hours. The camera will not work until it is turned back on.  "SLEEP" (P. 108), "4 h TIMER (Auto power off)" (P. 111)

The flash is charging

- When the flash is activated and the  symbol in the viewfinder is blinking, this indicates that the flash is charging. Wait for the blinking to stop, then press the shutter button.

Unable to focus

- When the AF confirmation mark in the viewfinder is blinking, it indicates that the camera is unable to focus using AF. Press the shutter button again.

Noise reduction is activated

- When shooting night scenes, shutter speeds are slower and noise tends to appear in images. The camera activates the noise-reduction process after shooting at slow shutter speeds. During which, shooting is not allowed. You can set **[NOISE REDUCT.]** to **[OFF]**.  "Noise reduction" (P. 72)

The date and time has not been set

The camera is used with the settings at the time of purchase

- The date and time of the camera is not set when purchased. Set the date and time before using the camera.  "Setting the date/time" (P. 14)

The battery has been removed from the camera

- The date and time settings will be returned to the factory default settings if the camera is left without the battery for approximately 1 day. The settings will be canceled more quickly if the battery was only loaded in the camera for a short time before being removed. Before taking important pictures, check that the date and time settings are correct.

Subjects that are difficult to focus on

It may be difficult to focus with auto focus in the following situations.

AF confirmation mark is blinking.
These subjects are not focused.



Subject with low contrast



Excessively bright light in center of frame

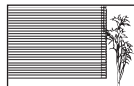

Subject with repeated patterns

AF confirmation mark lights up but the subject is not focused.



Subjects at different distances

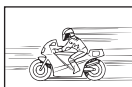

Fast-moving subject



Subject not inside AF area

In any situation, focus on something with high contrast that is at the same distance as the subject, determine the composition and shoot the picture.

Image taken appears whitish

This may occur when the picture is taken in backlight or semi-backlight conditions. This is due to a phenomenon called flare or ghosting. As far as possible, consider a composition where strong light source is not taken in the picture. Flare may occur even when a light source is not present in the picture. Use a lens hood to shade the lens from the light source. If a lens hood does not have effect, use your hand to shade the lens from the light.

☞ “Interchangeable lenses” (P. 138)

Unknown bright dot(s) appear on the subject in the picture taken

This may be due to stuck pixel (s) on the image pickup device. Perform **[PIXEL MAPPING]**. If the problem persists, repeat pixel mapping a few times. ☞ “Pixel mapping — Checking the image processing functions” (P. 135)

Functions that cannot be selected from menus

Some items may not be selectable from the menus when using the arrow pad.

- Items that cannot be set with the current shooting mode
- Items that cannot be set because of an item that has already been set:
Combination of **[L]** and **[NOISE REDUCT.]**, etc.













When the focus cannot be obtained with imager AF









When using a lens other than high-speed Imager AF-compatible, it may be difficult to focus depending on the subject. Setting **[PD AFL]** to **[ON]** in the Custom Menu allows to use the phase difference AF during live view by pressing AFL/AEL button ☞ “PD AFL” (P. 103). For the information about the high-speed Imager AF-compatible lens, visit the Olympus website.



Camera vibration when the power is turned off

This is due to the camera initializing the image stabilizer mechanism. Without this initialization, the image stabilizer may not be able to achieve the proper effect.

Error codes

Viewfinder indications	Control panel indications	Monitor indication	Possible cause	Corrective action
Normal indication	- - -	 NO CARD	The card is not inserted, or it cannot be recognized.	Insert a card or insert a different card.
	-E-	 CARD ERROR	There is a problem with the card.	Insert the card again. If the problem persists, format the card. If the card cannot be formatted, it cannot be used.
	-P-	 WRITE PROTECT	Writing to the card is prohibited.	The card has been set to read-only setting with the computer. Reset the card with the computer. The SD card write protect switch is on the LOCK side. Return the switch to enable writing.
	0	 CARD FULL	The card is full. No more pictures can be taken or no more information such as print reservation can be recorded.	Replace the card or erase unwanted pictures. Before erasing, download important images to a PC.
No indication	No indication	 CARD FULL	There is no space in the card and print reservation or new images cannot be recorded.	Replace the card or erase unwanted pictures. Before erasing, download important images to a PC.
No indication	No indication		SD Cards cannot be read or is not formatted.	<ul style="list-style-type: none"> Select [CLEAN CARD], press the  button and turn off the camera. Remove the card and wipe dry the metallic surface with a soft, dry cloth. Select [FORMAT]  [YES], and then press the  button to format the card. Formatting the card erases all data on the card.
No indication	No indication	 NO PICTURE	There are no pictures on the card.	The card contains no pictures. Record pictures and play back.

Viewfinder indications	Control panel indications	Monitor indication	Possible cause	Corrective action
No indication	No indication	 PICTURE ERROR	The selected picture cannot be displayed for playback due to a problem with this picture. Or the picture cannot be used for playback on this camera.	Use image processing software to view the picture on a PC. If that cannot be done, the image file is damaged.
No indication	No indication	 THE IMAGE CANNOT BE EDITED	Pictures taken with another camera cannot be edited on this camera.	Use image processing software to edit the picture.
No indication	No indication	 Internal camera temperature is too high. Please wait for cooling before camera use.	Extended use of live view or sequential shooting has increased the internal temperature of the camera.	Wait a moment for the camera to turn off automatically. Allow the internal temperature of the camera to cool before resuming operations.
No indication	No indication	 BATTERY EMPTY	The battery is drained.	Charge the battery.
No indication	No indication	 NO CONNECTION	The camera is not connected to the computer or printer correctly.	Disconnect the camera and connect it again correctly.
No indication	No indication	 NO PAPER	There is no paper in the printer.	Load some paper in the printer.
No indication	No indication	 NO INK	The printer has run out of ink.	Replace the ink cartridge in the printer.
No indication	No indication	 JAMMED	The paper is jammed.	Remove the jammed paper.

Viewfinder indications	Control panel indications	Monitor indication	Possible cause	Corrective action
No indication	No indication	SETTINGS CHANGED	The printer's paper cassette has been removed or the printer has been manipulated while making settings on the camera.	Do not manipulate the printer while making settings on the camera.
No indication	No indication	 PRINT ERROR	There is a problem with the printer and/or camera.	Turn off camera and printer. Check the printer and remedy any problems before turning the power on again.
No indication	No indication	 CANNOT PRINT	Pictures recorded on other cameras may not be printed on this camera.	Use a personal computer to print.

Camera maintenance

Cleaning and storing the camera

Cleaning the camera

Turn off the camera and remove the battery before cleaning the camera.

Exterior:

- Wipe gently with a soft cloth. If the camera is very dirty, soak the cloth in mild soapy water and wring well. Wipe the camera with the damp cloth and then dry it with a dry cloth. If you have used the camera at the beach, use a cloth soaked in clean water and well wrung.

Monitor and viewfinder:

- Wipe gently with a soft cloth.

Lens, mirror and focusing screen:

- Blow dust off the lens, mirror and focusing screen with a commercially available blower. For the lens, wipe gently with a lens cleaning paper.

Storage

- When not using the camera for a prolonged period, remove the battery and card. Store the camera in a cool, dry place that is well ventilated.
- Insert the battery periodically and test the camera's functions.

Cleaning and checking the image pickup device

This camera incorporates a dust reduction function to keep dust from getting on the image pickup device and to remove any dust or dirt from the image pickup device surface with ultrasonic vibrations. Dust reduction is activated when the power switch is set to ON and when starting and stopping live view. The dust reduction function operates at the same time as the pixel mapping, which checks the image pickup device and image processing circuitry. Since dust reduction is activated every time the camera's power is turned on, the camera should be held upright for the dust reduction function to be effective.

! Notes



- Do not use strong solvents such as benzene or alcohol, or a chemically treated cloth.
- Avoid storing the camera in places where chemicals are treated, in order to protect the camera from corrosion.
- Mold may form on the lens surface if the lens is left dirty.
- Check each part of the camera before use if it has not been used for a long time. Before taking important pictures, be sure to take a test shot and check that the camera works properly.

Cleaning mode — Removing dust

If dust or dirt gets on the image pickup device, black dots may appear in the picture. Contact your Olympus Authorized Service Center to have the image pickup device physically cleaned. The image pickup device is a precision device and is easily damaged. When cleaning the image pickup device yourself, be sure to follow the instructions below. If power runs out during cleaning, the shutter will close, which may cause the shutter curtain and mirror to break. Keep an eye on the remaining battery power.

1 Remove the lens from the camera, and set the power switch to ON.

2 MENU ▸ [M] ▸ [OK] ▸ [CLEANING MODE]

3 Press , then press the  button.

- The camera enters the cleaning mode.

4 Press the shutter button all the way.

- The mirror goes up and the shutter curtain opens.

5 Clean the image pickup device.

- Carefully blow off any dust on the surface of the image pickup device by using a mechanical blower (commercially available).

6 Be careful not to catch the mechanical blower in the shutter curtain when turning the power off to finish cleaning.

- If the camera turns off, the shutter curtain closes, causing the mirror to fall.

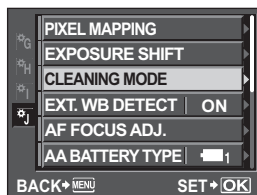



! Notes

- Be careful not to let the mechanical blower (commercially available) touch the image pickup device. If the blower touches the image pickup device, the image pickup device will be damaged.
- Never put the mechanical blower behind the lens mount. If the power turns off, the shutter closes, breaking the shutter curtain.
- Do not use anything other than the mechanical blower. If high-pressure gas is sprayed onto the image pickup device, it will freeze on the image pickup device's surface, damaging the image pickup device.

Pixel mapping — Checking the image processing functions

The pixel mapping feature allows the camera to check and adjust the image pickup device and image processing functions. After using the monitor or taking continuous shots, wait for at least one minute before using the pixel mapping function to ensure that it operates correctly.

1 MENU ▸ [M] ▸ [OK] ▸ [PIXEL MAPPING]

2 Press , then press the  button.

- The [BUSY] bar is displayed when pixel mapping is in progress. When pixel mapping is finished, the menu is restored.

! Notes

- If you accidentally turn the camera off during pixel mapping, start again from Step 1.

Card basics

Usable cards

"Card" in this manual refers to a recording medium. This camera can use CompactFlash or SD Card, SDHC card and the SDXC card (commercially available).

CompactFlash (Type I) (UDMA-compatible)

A CompactFlash is a large-capacity solid state flash memory card. You can use commercially available cards.

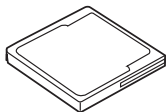

SD card

An SD card is a recording medium which are frequently used in compact cameras as well.



SD card write protect switch

The SD card body has a write protect switch. If you set the switch to the "LOCK" side, you will not be able to write to the card, delete data or format. Return the switch to enable writing.

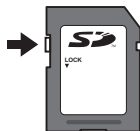

! Notes

- The data in the card will not be erased completely even after formatting the card or deleting the data. When discarding, destroy the card to prevent leakage of personal information.



Formatting the card

Cards formatted on a computer must be formatted with the camera before they can be used. All data stored on the card, including protected images, is erased when the card is formatted. When formatting a used card, confirm there are no images that you still want to keep on the card.

- MENU** ▸ **[M]** ▸ **[CARD SETUP]**
- Use **←** **→** to select **[FORMAT]**, then press the **OK** button.
- Use **←** **→** to select **[YES]**, then press the **OK** button.
 - Formatting is performed.

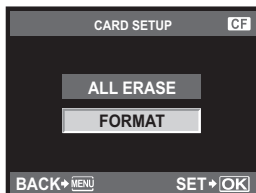

TIPS

When inserting cards into the two card slots:

→ Select the card to be used in **[CF]/[SD]**. I **→** "CF"/**SD**" (P. 116)

Battery and charger

- Use the single Olympus lithium-ion battery (BLM-5). Do not use other than Olympus genuine battery. The BLM-1 can be used, however be sure to use the dedicated charger (BCM-1 or BCM-2) when charging it. We recommend using BLM-5.
- The camera's power consumption varies widely with usage and other conditions.
- As the following consume a lot of power even without shooting, the battery will be drained quickly.
 - Performing auto focus repeatedly by pressing the shutter button halfway in shooting mode.
 - Using live view.
 - Displaying images on the LCD monitor for a prolonged period.
 - When connected to a computer or printer.
- When using a drained battery, the camera may turn off without the low battery warning being displayed.
- The battery will not be fully charged at the time of purchase. Charge the battery using the provided charger (BCM-5) before use.
- The normal charging time using the provided charger is approximately 3.5 hours (estimated).
- When charging the provided battery, never use the charger other than the dedicated one. Also do not use the provided charger for any battery other than the dedicated one.

Using your charger abroad

- The charger can be used in most home electrical sources within the range of 100 V to 240 V AC (50/60Hz) around the world. However, depending on the country or area you are in, the AC wall outlet may be shaped differently and the charger may require a plug adapter to match the wall outlet. For details, ask at your local electrical shop or travel agent.
- Do not use commercially available travel adaptors as the charger may malfunction.

Interchangeable lenses

Select the lens that you want to shoot with.

Use a specified Four Thirds lens (Four Thirds mount). When a non-specified lens is used, auto focus and light metering will not function correctly. In some cases, other functions may not work either.

- The Micro Four Thirds lens cannot be used.

FOUR THIRDS mount

Developed by Olympus as the lens mount standard for the Four Thirds system. These all-new interchangeable lenses featuring the Four Thirds mount were developed from the ground up based on optic engineering exclusively for digital cameras.

ZUIKO DIGITAL interchangeable lens

Four Thirds system interchangeable lens are designed to withstand rigorous professional use. The Four Thirds system makes it possible for a fast lens to be compact and lightweight as well.

Focal length and depth of field of Four Thirds system lenses

When compared to 35-mm cameras, Four Thirds system cameras achieve different effects at the same focal length and aperture.

Focal length

At the same focal length of a 35-mm camera, a Four Thirds system camera can achieve a focal length equivalent to twice that of a 35-mm camera. This enables the design of compact telephoto lenses. A 14-50 mm Four Thirds system lens, for example, is equivalent to a 28-100 mm lens for a 35-mm camera.

- When the image angle of Four Thirds system lens is converted to that of a 35-mm camera, the perspective is the same as that of a 35-mm camera.

Depth of Field

A Four Thirds system camera can achieve a depth of field equivalent to two times deeper than that of a 35-mm camera. A Four Thirds system lens with f2.0 brightness, for example, is equivalent to f4.0 when converted to the aperture of a 35-mm camera.

- You can achieve the same amount of background blur as if you were using a 35-mm camera.

! Notes

- When you attach or remove the body cap and lens from the camera, keep the lens mount on the camera pointed downward. This helps prevent dust and other foreign matter from getting inside the camera.
- Do not remove the body cap or attach the lens in dusty places.
- Do not point the lens attached to the camera toward the sun. This may cause the camera to malfunction or even ignite due to the magnifying effect of sunlight focusing through the lens.
- Be careful not to lose the body cap and rear cap.
- Attach the body cap to the camera to prevent dust from getting inside when no lens is attached.

ZUIKO DIGITAL lens specifications

Names of parts

- ① Hood mount section
- ② Filter mount thread
- ③ Zoom ring
- ④ Focus ring
- ⑤ Mount index
- ⑥ Electrical contacts
- ⑦ Front cap
- ⑧ Rear cap
- ⑨ Lens hood

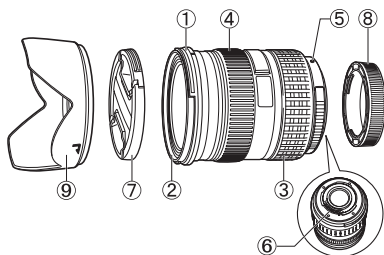

Attaching the hood

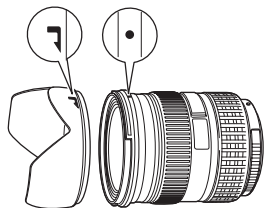

Storing the hood

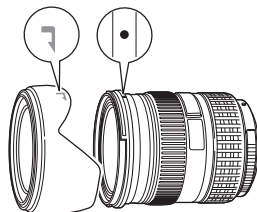

- Use the hood when shooting a backlit subject.

Main Specifications

Items	14-54 mm F2.8-3.5 II	ED 12-60mm F2.8-4.0 SWD
Mount	FOUR THIRDS mount	
Focal length	14 - 54 mm	12 - 60 mm
Max. aperture	f2.8 - 3.5	f2.8 - 4.0
Image angle	75° - 23°	84° - 20°
Lens configuration	11 groups, 15 lenses	10 groups, 14 lenses
	Multilayer film coating (partially single layered)	
Iris control	f2.8 - 22	f2.8 - 22
Shooting range	0.22 m - ∞	0.25 m - ∞
Focus adjustment	AF/MF switching	
Weight (excluding hood and cap)	440 g	575 g
Dimensions (Max. diameter × overall length)	ø74.5 × 88.5 mm	ø79.5 × 98.5 mm
Lens hood mount	Bayonet	
Filter mount thread diameter	67 mm	72 mm

Can be used with the optional EX-25 extension tube under the following conditions.
The focus adjustment when EX-25 is used will be MF.

Lens, focal length		Shooting range	Magnification (): Calculated based on 35 mm film camera
14-54 mm F2.8-3.5 II	14 mm	Shooting is not possible since subjects cannot be brought into focus at this focal length.	
	54 mm	17.7 cm - 22.2 cm	0.47 - 0.65× (0.94 - 1.3×)
ED 12-60mm F2.8-4.0 SWD	12 mm	Shooting is not possible since subjects cannot be brought into focus at this focal length.	
	60 mm	21 cm - 25.6 cm	0.43 - 0.58× (0.86 - 1.16×)

■ Storage Precautions

- Clean the lens after use. Remove dust and dirt on the surface of the lens with a blower brush or brush. Use commercially available lens cleaning paper to remove the dirt on the lens. Do not use organic solvents.
- Always cap the lens and store it when it is not used.
- Do not store in an area with insect repellent.

! Notes on Shooting

- Edges of pictures may be cut off if more than one filter is used or if a thick filter is used.

Program line diagram (P mode)

In the **P** mode, the camera is programmed such that the aperture value and shutter speed are automatically selected according to the subject's brightness as shown below. The program line diagram varies with the type of lens mounted.

— When using the
(14 - 54 mm f2.8 - 3.5
II) zoom lens
(focal length: 14 mm,
ISO100)

— Program shift

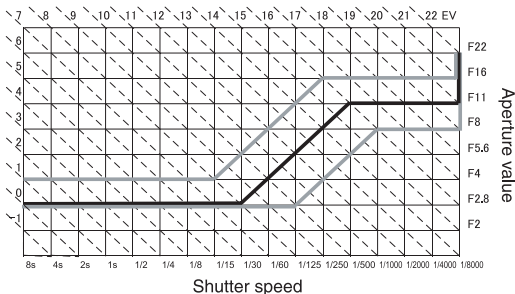

Flash synchronization and shutter speed

Shooting mode	Flash timing	Upper limit of synchronization timing*1	Fixed timing when flash fires*2
P	1/ (lens focal length × 2) or synchronization timing, whichever is slower	1/250	1/60
A			—
S	The set shutter speed	1/250	—
M			—

*1 Can be changed using menu: 1/60 - 1/250 "X-SYNC." (P. 112)

*2 Can be changed using menu: 30 - 1/250 "SLOW LIMIT" (P. 112)





































Exposure warning display

If the optimum exposure cannot be obtained when pressing the shutter button halfway, the display will blink in the viewfinder and on the super control panel.

Shooting mode	Warning display example (blinking)	Status	Action
P		The subject is too dark.	<ul style="list-style-type: none"> • Increase the ISO sensitivity. • Use the flash.
		The subject is too bright.	<ul style="list-style-type: none"> • Decrease the ISO sensitivity. • Use a commercially available ND filter (for adjusting the amount of light).
A		The subject is underexposed.	<ul style="list-style-type: none"> • Decrease the aperture value. • Increase the ISO sensitivity.
		The subject is overexposed.	<ul style="list-style-type: none"> • Increase the aperture value. • Decrease the ISO sensitivity or use a commercially available ND filter (for adjusting the amount of light).
S		The subject is underexposed.	<ul style="list-style-type: none"> • Set the shutter speed slower. • Increase the ISO sensitivity.
		The subject is overexposed.	<ul style="list-style-type: none"> • Set the shutter speed faster. • Decrease the ISO sensitivity or use a commercially available ND filter (for adjusting the amount of light).

* The aperture value at the moment when its indication blinks varies with the lens type and focal length of the lens.

Flash modes that can be set by shooting mode

Shooting mode	Viewfinder indications	Control panel indications	Super control panel indications	Flash mode	Flash timing	Conditions for firing the flash	Shutter speed limit
P A  	 -R	 -A	 AUTO	Auto flash	1st curtain	Fires automatically in dark/backlit ^{*1} conditions	1/30 sec. - 1/250 sec.
	 00 -R	 -A 		Auto flash (red-eye reduction)			
				Fill-in flash		Always fires	30 sec. - 1/250 sec
	 OFF	 OFF		Flash off	—	—	—
	 SLo00 -R	 -A  SLOW	 SLOW	Slow synchronization (red-eye reduction)	1st curtain	Fires automatically in dark/backlit ^{*1} conditions	60 sec. - 1/250 sec.
	 SLo -R	 -A SLOW	 SLOW	Slow synchronization (1st curtain)			
	 SLo2 -R	 -A 2nd-CURTAIN	 SLOW2	Slow synchronization (2nd curtain)	2nd curtain		
	 FULL	 FULL	 FULL	Manual flash (FULL)	1st curtain	Always fires	
	 1-4	 1-4	 1/4	Manual flash (1/4)			
	 1-16	 1-16	 1/16	Manual flash (1/16)			
 1-64	 1-64	 1/64	Manual flash (1/64)				

*1 When the flash is set to the Super FP mode, it detects backlight with longer duration than for normal flash before emitting light.  "Super FP flash" (P. 79)

Shooting mode	Viewfinder indications	Control panel indications	Super control panel indications	Flash mode	Flash timing	Conditions for firing the flash	Shutter speed limit
S M (BULB)	⚡	⚡	⚡	Fill-in flash	1st curtain	Always fires	60 sec. - 1/250 sec.
	⚡ □□	⚡ ◉	◉ ⚡	Fill-in flash (red-eye reduction)			
	⚡ □FF	⚡ □FF	Ⓢ	Flash off			
	⚡ 2	⚡ 2nd-CURTAIN	2nd CURTAIN	Fill-in flash/ Slow synchronization (2nd curtain)	2nd curtain	Always fires	60 sec. - 1/250 sec.
	⚡ FULL	⚡ FULL	FULL	Manual flash (FULL)	1st curtain		
	⚡ 1-4	⚡ 1-4	⚡ 1/4	Manual flash (1/4)			
	⚡ 1-16	⚡ 1-16	⚡ 1/16	Manual flash (1/16)			
	⚡ 1-64	⚡ 1-64	⚡ 1/64	Manual flash (1/64)			

White balance color temperature

The higher the color temperature, the richer the light in bluish tones and the poorer in reddish; the lower the color temperature, the richer the light in reddish tones and the poorer in bluish. The spectral balance of different white light sources is rated numerically by color temperature - concept of physics expressed using the Kelvin (K) temperature scale. The color of sunlight and other natural light sources and the color of a light bulb and other artificial light sources can be expressed in terms of color temperature.

It follows, then, that the color temperatures of fluorescent lights make them unsuitable as artificial light sources. There are gaps in the hues from the color temperatures of fluorescent light. If these differences in hue are small, they can be calculated with color temperature and this is called correlated color temperature.

The 4000K preset setting in this camera are correlated color temperatures, and should not be considered strictly as color temperatures. Use these settings for shooting conditions under fluorescent lights.

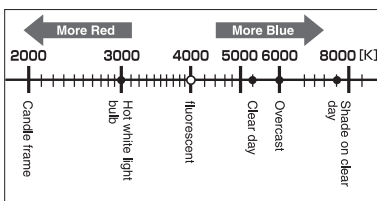

- The color temperatures for each light source indicated in the above scale are approximate.

Record mode and file size/number of storable still pictures

The file size in the table is approximate for files with a 4:3 aspect ratio.

Record mode	Number of pixels (PIXEL COUNT)	Compression	File format	File size (MB)	Number of storable still pictures (with 1GB SD Card)
RAW	4032 × 3024	Loss-less compression	ORF	Approx. 14	54
L ^{SF}		1/2.7		Approx. 8.4	101
L ^F		1/4		Approx. 5.9	145
L ^N		1/8		Approx. 2.7	320
L ^B		1/12		Approx. 1.8	477
M ^{SF}	3200 × 2400	1/2.7	JPEG	Approx. 5.6	154
M ^F		1/4		Approx. 3.4	255
M ^N		1/8		Approx. 1.7	504
M ^B		1/12		Approx. 1.2	747
M ^{SF}	2560 × 1920	1/2.7		Approx. 3.2	269
M ^F		1/4		Approx. 2.2	395
M ^N		1/8		Approx. 1.1	776
M ^B		1/12		Approx. 0.8	1143
M ^{SF}	1600 × 1200	1/2.7		Approx. 1.3	673
M ^F		1/4		Approx. 0.9	993
M ^N		1/8		Approx. 0.5	1893
M ^B		1/12		Approx. 0.4	2753
S ^{SF}	1280 × 960	1/2.7		Approx. 0.9	1044
S ^F		1/4		Approx. 0.6	1514
S ^N		1/8		Approx. 0.3	2884
S ^B		1/12		Approx. 0.3	4038
S ^{SF}	1024 × 768	1/2.7		Approx. 0.6	1594
S ^F		1/4		Approx. 0.4	2243
S ^N		1/8		Approx. 0.3	4038
S ^B		1/12		Approx. 0.2	5507
S ^{SF}	640 × 480	1/2.7	Approx. 0.3	3563	
S ^F		1/4	Approx. 0.2	5048	
S ^N		1/8	Approx. 0.2	8654	
S ^B		1/12	Approx. 0.1	10096	

! Notes

- The number of remaining pictures may change according to the subject or factors like whether print reservations have been made or not. In certain instances, the number of remaining pictures displayed on the viewfinder or the LCD monitor does not change even when you take pictures or stored images are erased.
- The actual file size varies according to the subject.
- The maximum number of storable still pictures displayed on the monitor is 9999.
- The maximum number of storable still pictures displayed on the control panel is 999.

Record mode	Image size	Frame rate	Available recording time (SD/SDHC/SDXC card)
			2GB
HD	1280 x 720 (16 : 9)	30fps	Approx. 7 min.
SD	640 x 480 (4 : 3)	30fps	Approx. 14 min.

Functions that can be registered with MYSET setting

























Function	MYSET registration	Function	MYSET registration
Shooting mode	✓	WB	✓
	✓	ALL WB	—
Aperture value	✓	MULTIPLE EXPOSURE	—
Shutter speed	✓	DIAL FUNCTION	✓
IMAGE STABILIZER (I.S.)	✓	DIAL DIRECTION	✓
	✓	AEL/AFL	✓
	STILL PICTURE	AEL/AFL MEMO	✓
	MOVIE	LIVE VIEW BOOST	✓
IMAGE ASPECT	✓	QUICK ERASE	✓
WB	✓	RAW+JPEG ERASE	✓
	✓	BUTTON FUNCTION	✓
ISO	✓		✓
NOISE REDUCT.	✓	FOCUS RING	✓
NOISE FILTER	✓	BULB FOCUSING	—
METERING	✓	AF ILLUMINAT.	✓
EXPOSURE SHIFT	✓	L fps	✓
RC MODE	✓	RLS PRIORITY S	✓
AF MODE	✓	RLS PRIORITY C	✓
AF AREA	✓	RESET LENS	—
	—	FACE DETECT	✓
AF AREA POINTER	—	/INFO SETTING	✓
C-AF LOCK	—	CONTROL SETTING	✓
AF SENSITIVITY	—	PICTURE MODE SETTINGS	✓
	—	LEVEL GAUGE	✓
PD AFL	✓	ASPECT SHOOTING	✓
AF FOCUS ADJ.	✓	AA BATTERY TYPE	✓
MF ASSIST	✓	WARNING LEVEL	—
AE BKT	✓	LEVEL ADJUST	—
ISO BKT	✓	EXT. WB DETECT	✓
WB BKT	✓	MOVIE	✓
FL BKT	✓	HDMI	—
FLASH MODE	✓	VOLUME	—
	✓	HISTOGRAM SETTINGS	—
X-SYNC.	✓		—
SLOW LIMIT	✓		—
ISO STEP	✓	EDIT FILENAME	—
ISO-AUTO SET	✓		—
EV STEP	✓		—
BULB TIMER	✓	PRIORITY SET	—
VIDEO OUT	—		✓

Function	MYSET registration	Function	MYSET registration
REC VIEW	✓	dpi SETTING	—
SLEEP	✓	USB MODE	—
BACKLIT LCD	✓	COLOR SPACE	✓
4 h TIMER	—	SHADING COMP.	✓
BUTTON TIMER	—	☰ MENU DISPLAY	—
	—	COPYRIGHT SETTINGS	—
Program shift	—	FILE NAME	—

✓: Can be registered. —: Cannot be registered.

Menu directory

Shooting Menu

Tab	Function	Setting	Ref. page	
	CARD SETUP	ALL ERASE/FORMAT	P. 98 P. 136	
	RESET/MYSET	RESET		P. 100
		MYSET1	SET/RESET	
		MYSET2	SET/RESET	
		MYSET3	SET/RESET	
PICTURE MODE	 i-ENHANCE/  VIVID/  NATURAL/  MUTED/  PORTRAIT/MONOTONE/CUSTOM/  POP ART/  SOFT FOCUS/  PALE&LIGHT COLOR/  LIGHT TONE/  GRAINY FILM/  PIN HOLE/  DIORAMA/  CROSS PROCESS/  GENTLE SEPIA/  DRAMATIC TONE		P. 70	
		STILL	RAW/  L/F/  LN+/  M/N/  S/N/  L/F+RAW/  LN+RAW/ PICTURE  M/N+RAW/  S/N+RAW	P. 64
MOVIE		HD*/SD	P. 84	
	IMAGE ASPECT	4:3*/16:9/3:2/6:6/5:4/7:6/6:5/7:5/3:4	P. 65	

* Factory default setting

Tab	Function	Setting		Ref. page	
	IMAGE STABILIZER	OFF/I.S. 1*/I.S. 2/I.S. 3		P. 62	
	BRACKETING	AE BKT	OFF*/2F 0.3EV/2F 0.5EV/2F 0.7EV/2F 1.0EV/ 3F 0.3EV/3F 0.5EV/3F 0.7EV/3F 1.0EV/5F 0.3EV/5F 0.5EV/5F 0.7EV/5F 1.0EV/7F 0.3EV/ 7F 0.5EV/7F 0.7EV	P. 49	
			OVER EXP. PIC./ UNDER EXP. PIC.(2F)		
		WB BKT	A-B	OFF*/3F 2STEP/	P. 69
			G-M	3F 4STEP/3F 6STEP	
		FL BKT	OFF*/3F 0.3EV/3F 0.5EV/3F 0.7EV/3F 1.0EV		P. 77
	ISO BKT	OFF*/3F 0.3EV/3F 0.7EV/3F 1.0EV		P. 51	
	MULTIPLE EXPOSURE	FRAME	OFF*/2F/3F/4F		P. 51
		AUTO GAIN	OFF*/ON		
OVERLAY		OFF*/ON			
RC MODE	OFF*/ON		P. 80		

* Factory default setting

Playback Menu

































Tab	Function	Setting		Ref. page	
		START		P. 90	
		BGM	MELANCHOLY*/NOSTALGIC/LOVE/JOY/ COOL/OFF		
		SLIDE	ALL*/STILL PICTURE/MOVIE		
		SLIDE INTERVAL	2 SEC - 10 SEC (3 SEC*)		
		MOVIE INTERVAL	FULL/SHORT*		
			OFF/ON*		P. 91
	EDIT	SEL. IMAGE	RAW DATA EDIT		P. 93
		SEL. IMAGE	JPEG EDIT	SHADOW ADJ/REDEYE FIX/ []/ASPECT/BLACK & WHITE/ SEPIA/SATURATION/[]/e- PORTRAIT	
				NO/[] START/ YES	
	IMAGE OVERLAY	2IMAGES MERGE*/3IMAGES MERGE/ 4IMAGES MERGE		P. 95	
			P. 121		
COPY ALL	YES/NO		P. 96		
RESET PROTECT	YES/NO		P. 97		

* Factory default setting

Custom Menu

Tab	Function	Setting	Ref. page
	AF/MF		P. 102
	AF AREA	[:::]*/[·]/[:::]	P. 102
	SET UP	OFF/LOOP/SPIRAL*	P. 102
	RESET LENS	OFF/ON*	P. 102
	BULB FOCUSING	OFF/ON*	P. 102
	FOCUS RING	↻*/↻	P. 103
	MF ASSIST	OFF*/ON	P. 103
	SET HOME	[:::]*/[·]/[:::]	P. 103
	PD AFL	OFF*/ON	P. 103
	AF ILLUMINAT.	OFF/ON*	P. 103
	C-AF LOCK	OFF*/ON	P. 103
	AF AREA POINTER	OFF/ON*	P. 103
	AF SENSITIVITY	NORMAL*/SMALL	P. 103
	BUTTON/DIAL		P. 104
	DIAL FUNCTION	P	Ps*//
A		FNo.*//	
S		SHUTTER*//	
M		Main dial: SHUTTER*/FNo. Sub dial: SHUTTER/FNo.*	
MENU		Main dial: ◀▶/↕/VALUE* Sub dial: ◀▶/↕/VALUE	
		Main dial:rewind/advance frame/ * Sub dial:rewind/advance frame*/ 	
DIAL DIRECTION	DIAL1*/DIAL2	P. 104	
AEL/AFL	S-AF*	mode1*/mode2/mode3	P. 105
	C-AF	mode1/mode2*/mode3/mode4	
	MF	mode1*/mode2/mode3	
AEL/AFL MEMO	OFF/ON*	P. 106	
BUTTON FUNCTION	Fn button function	Fn FACE DETECT/PREVIEW/LIVE PREVIEW//[] HOME/MF/RAW ◀-/ P/A/S/M /TEST PICTURE/MYSET1/MYSET2/MYSET3/MYSET4//[]/LEVEL GAUGE/MAGNIFY*/AF AREA SELECT/IS MODE/OFF	P. 106

* Factory default setting

























Tab	Function	Setting	Ref. page	
	 BUTTON FUNCTION	 button function AF AREA SELECT*/  /[] HOME/MF/RAW  -P/A/S/M/TEST PICTURE/MYSET1/MYSET2/MYSET3/MYSET4/LEVEL GAUGE/IS MODE/OFF	P. 106	
		 (preview) button function AF AREA SELECT/Fn FACE DETECT/PREVIEW*/LIVE PREVIEW/  /[] HOME/MF/RAW  -P/A/S/M/TEST PICTURE/MYSET1/MYSET2/MYSET3/MYSET4/LEVEL GAUGE/MAGNIFY/IS MODE/OFF		
		 BUTTON FUNCTION OFF/[]*		
	BUTTON TIMER	3SEC/5SEC/8SEC*/HOLD/OFF		P. 107
	  Fn	OFF*/ON		P. 107
		RELEASE		P. 108
		RLS PRIORITY S	OFF*/ON	P. 108
		RLS PRIORITY C	OFF/ON*	
		 Lfps	1fps/2fps/3fps*/4fps	P. 108
		DISP/  /PC		P. 108
	HDMI	HDMI OUT 1080i*/720p/480p/576p HDMI CONTROL OFF*/ON	P. 108	
	VIDEO OUT	*1	P. 108	
	SLEEP	OFF/1MIN*/3MIN/5MIN/10MIN	P. 108	
	LIVE VIEW BOOST	OFF*/ON	P. 109	
	 FACE DETECT	OFF*/ON	P. 109	
	 /INFO SETTINGS	 INFO IMAGE ONLY/OVERALL/  /HIGHLIGHT&SHADOW	P. 109	
		LV-INFO DISPLAYED GRID(OFF/  /  /  / )/  /HIGHLIGHT&SHADOW/ZOOM/MULTI VIEW/IMAGE ONLY		
		 SETTINGS  4/  9/  25/  100/CALENDAR		
	 CONTROL SETTINGS	LIVE CONTROL	OFF/ON*	P. 109
		CONTROL PANEL	OFF*/ON	

* Factory default setting

*1Settings differ depending on the region where the camera is purchased.

Tab	Function	Setting	Ref. page	
	HISTOGRAM SETTINGS	HIGHLIGHT/SHADOW	P. 109	
	BACKLIT LCD	8 SEC*/30 SEC/1 MIN/HOLD	P. 109	
		OFF/ON*	P. 109	
	VOLUME	0 to 5(3*)	P. 109	
	USB MODE	AUTO*/STORAGE/MTP/PRINT/CONTROL	P. 110	
	LEVEL GAUGE	OFF*/ON	P. 110	
	4 h TIMER	OFF/4 h	P. 111	
	PICTURE MODE SETTINGS	i-ENHANCE/ VIVID/ MUTED/ PORTRAIT/ MONOTONE/ CUSTOM/POP ART/SOFT FOCUS/ PALE&LIGHT COLOR/LIGHT TONE/GRAINY FILM/PIN HOLE/ DIORAMA/ CROSS PROCESS/ GENTLE SEPIA/ DRAMATIC TONE	OFF/ON*	P. 111
	EXP/ ISO			P. 111
	EV STEP	1/3EV*/1/2EV/1EV		P. 111
METERING	*	ESP + AF/ESP*	P. 111	
AELMetering	AUTO*///SH		P. 111	
ISO STEP	1/3EV*/1EV		P. 111	
ISO-AUTO SET	HIGH LIMIT	200 - 6400(1600*)	P. 111	
	DEFAULT	200 - 6400(200*)		
ISO-AUTO	P/A/S* /ALL		P. 112	
BULB TIMER	1MIN - 30MIN(8 MIN*)		P. 112	
ANTI-SHOCK[]	OFF*/1/8 SEC - 30 SEC		P. 112	
CUSTOM			P. 112	
X-SYNC.	1/60 - 1/250(1/250*)		P. 112	
SLOW LIMIT	30 - 1/250(1/30*)		P. 112	
+	OFF*/ON		P. 112	

* Factory default setting

Tab	Function	Setting	Ref. page	
	 ASPECT/COLOR/WB		P. 113	
	NOISE REDUCT.	OFF/ON/AUTO*	P. 113	
	NOISE FILTER	OFF/LOW/STANDARD*/HIGH	P. 113	
	WB	AUTO*	A -7- +7,G -7- +7	P. 113
		 5300K	A -7- +7,G -7- +7	
		 7500K	A -7- +7,G -7- +7	
		 6000K	A -7- +7,G -7- +7	
		 3000K	A -7- +7,G -7- +7	
		 4000K	A -7- +7,G -7- +7	
		 5000K	A -7- +7,G -7- +7	
		 WB 5500K	A -7- +7,G -7- +7	
		 5000K	A -7- +7,G -7- +7	
		 5000K	A -7- +7,G -7- +7	
		 5000K	A -7- +7,G -7- +7	
		 5000K	A -7- +7,G -7- +7	
		CWB	2,000K - 14,000K	
	ALL 	ALL SET	A -7- +7,G -7- +7	P. 113
		ALL RESET	YES/NO	
	COLOR SPACE	sRGB*/AdobeRGB		P. 114
	SHADING COMP.	OFF*/ON		P. 114
	 -SET	 -1-  :4	 /M/S, SF/F/N/B	P. 114
	PIXEL COUNT	 iddle	3200 × 2400/2560 × 1920*/ 1600 × 1200	P. 114
		 mall	1280 × 960*/1024 × 768/640 × 480	
	ASPECT SHOOTING	LV*/ALL		P. 115
	 RECORD/ERASE			P. 115
	QUICK ERASE	OFF*/ON		P. 115
	RAW+JPEG ERASE	JPEG/RAW/RAW+JPEG*		P. 115
FILE NAME	AUTO*/RESET		P. 116	
EDIT FILENAME	Adobe RGB	OFF*/A - Z/0 - 9	P. 116	
	sRGB			
PRIORITY SET	NO*/YES		P. 116	
dpi SETTING	AUTO*/CUSTOM		P. 116	
 /SD	CF*/SD		P. 116	
COPYRIGHT SETTINGS	COPYRIGHT INFO.	OFF*/ON	P. 117	
	ARTIST NAME	—		
	COPYRIGHT NAME	—		
 MOVIE			P. 117	
 MOVIE 	OFF/ON*		P. 117	

* Factory default setting

Tab	Function	Setting	Ref. page	
	UTILITY		P. 117	
	PIXEL MAPPING	—	P. 117	
	EXPOSURE SHIFT	-1-0* to +1	P. 117	
	CLEANING MODE	—	P. 117	
	EXT. WB DETECT	OFF/ON*	P. 117	
	AF FOCUS ADJ.	SET AF DATA	OFF*/DEFAULT DATA/LENS DATA	P. 118
		DATA LIST	Registered lens information①/ Registered lens information②/ Registered lens③	
	AA BATTERY TYPE	1*/2*/3	P. 119	
	WARNING LEVEL	-2 - 0* - +2	P. 120	
	LEVEL ADJUST	RESET/ADJUST	P. 120	

* Factory default setting

Setup Menu

Tab	Function	Setting	Ref. page	
		—	P. 99	
		*1	P. 99	
			-7 to +7 -7 to +7 (±0, ±0*)	P. 99
		AUTO BRIGHTNESS	OFF/ON*	
	REC VIEW	AUTO /OFF/1SEC to 20SEC (5SEC*)	P. 99	
	MENU DISPLAY	OFF/ON*	P. 99	
	FIRMWARE	—	P. 100	

* Factory default setting

*1 Settings differ depending on the region where the camera is purchased.

Specifications

Camera specifications

■ Product type

Product type	: Single-lens reflex digital camera with interchangeable lens system
Lens	: Zuiko Digital, Four Thirds System Lens
Lens mount	: Four Thirds mount
Equivalent focal length on a 35 mm film camera	: Approx. twice the focal length of the lens

■ Image pickup device

Product type	: 4/3" Live MOS sensor
No. of total pixels	: Approx. 13,100,000 pixels
No. of effective pixels	: Approx. 12,300,000 pixels
Screen size	: 17.3 mm (H) × 13.0 mm (V) (0.7" × 0.5")
Aspect ratio	: 1.33 (4:3)

■ Viewfinder

Product type	: Eye-level single-lens reflex viewfinder
Field of view	: Approx. 100% (for field of view on recorded images)
Viewfinder magnification	: Approx. 1.15× (-1 m ⁻¹ , 50 mm lens, infinity)
Eye point	: Approx. 20mm from cover glass (1.0") (-1 m ⁻¹)
Diopter adjustment range	: -3.0 - +1.0 m ⁻¹
Optical path fraction	: Quick return half mirror
Depth of field	: Can be checked with the preview button
Focusing screen	: Fixed (Can be exchanged with FS-3 (available separately) at Olympus service station)
Eyecup	: Interchangeable

■ Live view

	: Uses Live MOS sensor for shooting
	: Field of view of 100%

■ LCD monitor (Movable)

Product type	: 3" TFT color LCD
Total no. of pixels	: Approx. 920,000 dots

■ Shutter

Product type	: Computerized focal-plane shutter
Shutter	: 1/8000 - 60 sec., Bulb shooting

■ Auto focus

Product type	: TTL phase-contrast detection system/Imager contrast detection system
Focusing points	: 11 points
AF luminance range	: EV -2 - EV 19 (ISO 100 equivalent, at room temperature 20 °C (68 °F), TTL phase-contrast detection system)
Selection of focusing point	: Auto, Optional
AF illuminator	: The built-in flash provides light.

■ Exposure control

Metering system	: TTL full-aperture metering system (1) Digital ESP metering (2) Center weighted averaging metering (3) Spot metering (approx. 2% for the viewfinder screen)
Metering range	: EV 1 - 20 (Digital ESP metering, Center weighted average metering, Spot metering) (At room temperature, 50 mm f2, ISO 100)
Shooting modes	: (1) P : Program AE (Program shift can be performed) (2) A : Aperture priority AE (3) S : Shutter priority AE (4) M : Manual (5) B : BULB
ISO sensitivity	: 100 - 6400 (1/3, 1 EV step)
Exposure compensation	: ±5 EV (1/3, 1/2, 1 EV step)

■ White balance

Product type	: Image pickup device and white balance sensor
Mode setting	: Auto, Preset WB, Customized WB, One-touch WB

■ Recording

Memory	: CF card (Compatible with Type I) (UDMA-compatible) SD Card/SDHC Card/SDXC Card
Recording system	: Digital recording, JPEG (in accordance with Design rule for Camera File system (DCF)), RAW Data
Applicable standards	: Exif 2.2, Digital Print Order Format (DPOF), PRINT Image Matching III, PictBridge

■ Playback

Playback mode	: Single-frame playback, Close-up playback, Index display, Image rotation, Slideshow, Light box display, Calendar display
Information display	: Information display, Histogram display

■ Drive

Drive mode	: Single-frame shooting, Sequential shooting, Self-timer, Remote control
Sequential shooting	: Approx. 5 frames/sec.
Self-timer	: Operation time: 12 sec., 2 sec.
Optical remote control	: Operation time: 2 sec., 0 sec. (instantaneous shooting) (RM-1 Remote Control (optional))

■ Flash

Synchronization	: Synchronized with the camera at 1/250 sec. or less
Flash control mode	: TTL-AUTO (TTL pre-flash mode), AUTO, MANUAL
External flash attachment	: Hot shoe, External flash connector (x attachment)
Wireless flash function	: Compatible with the Olympus wireless RC flash system

■ External connector

Microphone connector/HDMI mini connector (Type C)/ USB terminal/
AV OUT connector/ Remote cable connector/ External flash
connector (x attachment)

■ Power supply

Battery	: Li-ion Battery (BLM-5) ×1
---------	-----------------------------

■ Dimensions/weight

Dimensions : 142.5 mm (W) × 116.5 mm (H) × 74.5 mm (D) (5.6" × 4.6" × 2.9")
(excluding protrusions)

Weight : Approx. 892 g (2.0 lb.) (Including battery/CF card)

■ Operating environment

Temperature : 0 °C - 40 °C (32 °F - 104 °F) (operation)/
-20 °C - 60 °C (-4 °F - 140 °F) (storage)

Humidity : 30 - 90% (operation)/10 - 90% (storage)

HDMI, the HDMI logo and High-Definition Multimedia Interface are trademarks or registered trademarks of HDMI Licensing LLC.



Battery/charger specifications

BLM-5 Lithium ion battery

MODEL NO.	: BLM-5
Product type	: Rechargeable Lithium ion battery
Nominal voltage	: DC 7.4 V
Nominal capacity	: 1620 mAh
No. of charge and discharge times	: Approx. 500 times (varies with usage conditions)
Ambient temperature	: 0 °C - 40 °C (32 °F - 104 °F) (charging) -20 °C - 35 °C (-4 °F - 95 °F) (storage)

BCM-5 Lithium ion charger

MODEL NO.	: BCM-5
Rated input	: 100 to 240 V AC(50/60 Hz)
Rated output	: DC 8.4 V, 600 mA
Charging time	: Approx. 3.5 hours (room temperature if using BLM-5)
Ambient temperature	: 0 °C - 40 °C (32 °F - 104 °F) (operation)/ -20 °C - 60 °C (-4 °F - 140 °F) (storage)

* The provided AC cable is dedicated to this product. Do not use with other devices. Do not use cables of other products for this product.

SPECIFICATIONS ARE SUBJECT TO CHANGE WITHOUT ANY NOTICE OR OBLIGATION ON THE PART OF THE MANUFACTURER.

SAFETY PRECAUTIONS



CAUTION

RISK OF ELECTRIC SHOCK
DO NOT OPEN



CAUTION: TO REDUCE THE RISK OF ELECTRICAL SHOCK, DO NOT REMOVE COVER (OR BACK). NO USER-SERVICEABLE PARTS INSIDE. REFER SERVICING TO QUALIFIED OLYMPUS SERVICE PERSONNEL.



An exclamation mark enclosed in a triangle alerts you to important operating and maintenance instructions in the documentation provided with the product.



DANGER

If the product is used without observing the information given under this symbol, serious injury or death may result.



WARNING

If the product is used without observing the information given under this symbol, injury or death may result.



CAUTION

If the product is used without observing the information given under this symbol, minor personal injury, damage to the equipment, or loss of valuable data may result.

WARNING!

TO AVOID THE RISK OF FIRE OR ELECTRICAL SHOCK, NEVER DISASSEMBLE, EXPOSE THIS PRODUCT TO WATER OR OPERATE IN A HIGH HUMIDITY ENVIRONMENT.

General Precautions

Read All Instructions — Before you use the product, read all operating instructions. Save all manuals and documentation for future reference.

Cleaning — Always unplug this product from the wall outlet before cleaning. Use only a damp cloth for cleaning. Never use any type of liquid or aerosol cleaner, or any type of organic solvent to clean this product.

Attachments — For your safety, and to avoid damaging the product, use only accessories recommended by Olympus.

Water and Moisture — For precautions on products with weatherproof designs, read the weatherproofing sections.

Location — To avoid damage to the product, mount the product securely on a stable tripod, stand, or bracket.

Power Source — Connect this product only to the power source described on the product label.

Foreign Objects — To avoid personal injury, never insert a metal object into the product.

Heat — Never use or store this product near any heat source such as a radiator, heat register, stove, or any type of equipment or appliance that generates heat, including stereo amplifiers.

Product Handling Precautions



WARNING

- Do not use the camera near flammable or explosive gases.
- Do not use the flash and LED on people (infants, small children, etc.) at close range.
 - You must be at least 1 m (3 ft.) away from the faces of your subjects. Firing the flash too close to the subject's eyes could cause a momentary loss of vision.
- Keep young children and infants away from the camera.
 - Always use and store the camera out of the reach of young children and infants to prevent the following dangerous situations which could cause serious injury:
 - Becoming entangled in the camera strap, causing strangulation.
 - Accidentally swallowing the battery, cards or other small parts.
 - Accidentally firing the flash into their own eyes or those of another child.
 - Accidentally being injured by the moving parts of the camera.
- Do not look at the sun or strong lights with the camera.
- Do not use or store the camera in dusty or humid places.
- Do not cover the flash with a hand while firing.



CAUTION

- Stop using the camera immediately if you notice any unusual odors, noise, or smoke around it.
 - Never remove the batteries with bare hands, which may cause a fire or burn your hands.
- Never hold or operate the camera with wet hands.
- Do not leave the camera in places where it may be subject to extremely high temperatures.
 - Doing so may cause parts to deteriorate and, in some circumstances, cause the camera to catch fire. Do not use the charger if it is covered (such as a blanket). This could cause overheating, resulting in fire.
- Handle the camera with care to avoid getting a low-temperature burn.
 - When the camera contains metal parts, overheating can result in a low-temperature burn. Pay attention to the following:
 - When used for a long period, the camera will get hot. If you hold on to the camera in this state, a low-temperature burn may be caused.
 - In places subject to extremely cold temperatures, the temperature of the camera's body may be lower than the environmental temperature. If possible, wear gloves when handling the camera in cold temperatures.
- Be careful with the strap.
 - Be careful with the strap when you carry the camera. It could easily catch on stray objects - and cause serious damage.

Battery Handling Precautions

Follow these important guidelines to prevent batteries from leaking, overheating, burning, exploding, or causing electrical shocks or burns.



DANGER

- The camera uses a lithium ion battery specified by Olympus. Charge the battery with the specified charger. Do not use any other chargers.
- Never heat or incinerate batteries.
- Take precautions when carrying or storing batteries to prevent them from coming into contact with any metal objects such as jewelry, pins, fasteners, etc.
- Never store batteries where they will be exposed to direct sunlight, or subjected to high temperatures in a hot vehicle, near a heat source, etc.
- To prevent causing battery leaks or damaging their terminals, carefully follow all instructions regarding the use of batteries. Never attempt to disassemble a battery or modify it in any way, by soldering, etc.
- If battery fluid gets into your eyes, flush your eyes immediately with clear, cold running water and seek medical attention immediately.
- Always store batteries out of the reach of small children. If a child accidentally swallows a battery, seek medical attention immediately.



WARNING

- Keep batteries dry at all times.
- To prevent batteries from leaking, overheating, or causing a fire or explosion, use only batteries recommended for use with this product.
- Insert the battery carefully as described in the operating instructions.

- If rechargeable batteries have not been recharged within the specified time, stop charging them and do not use them.
- Do not use a battery if it is cracked or broken.
- If a battery leaks, becomes discolored or deformed, or becomes abnormal in any other way during operation, stop using the camera.
- If a battery leaks fluid onto your clothing or skin, remove the clothing and flush the affected area with clean, running cold water immediately. If the fluid burns your skin, seek medical attention immediately.
- Never subject batteries to strong shocks or continuous vibration.



CAUTION

- Before loading, always inspect the battery carefully for leaks, discoloration, warping, or any other abnormality.
- The battery may become hot during prolonged use. To avoid minor burns, do not remove it immediately after using the camera.
- Always unload the battery from the camera before storing the camera for a long period.
- This camera uses a lithium ion battery specified by Olympus. Do not use any other type of battery. For safe and proper use, read the battery's instruction manual carefully before using it.
- If the battery's terminals get wet or greasy, camera contact failure may result. Wipe the battery well with a dry cloth before use.
- Always charge a battery when using it for the first time, or if it has not been used for a long period.
- When operating the camera with battery power at low temperatures, try to keep the camera and spare battery as warm as possible. A battery that has run down at low temperatures may be restored after it is warmed at room temperature.
- The number of pictures you can take may vary depending on the shooting conditions or battery.
- Before going on a long trip, and especially before traveling abroad, purchase extra batteries. A recommended battery may be difficult to obtain while traveling.
- Please recycle batteries to help save our planet's resources. When you throw away dead batteries, be sure to cover their terminals and always observe local laws and regulations.

Caution for Usage Environment

- To protect the high-precision technology contained in this product, never leave the camera in the places listed below, no matter if in use or storage:
 - Places where temperatures and/or humidity are high or go through extreme changes. Direct sunlight, beaches, locked cars, or near other heat sources (stove, radiator, etc.) or humidifiers.
 - In sandy or dusty environments.
 - Near flammable items or explosives.
 - In wet places, such as bathrooms or in the rain. When using products with weatherproof designs, read their manuals as well.
 - In places prone to strong vibrations.
- Never drop the camera or subject it to severe shocks or vibrations.
- When mounted on a tripod, adjust the position of the camera with the tripod head. Do not twist the camera.
- Do not leave the camera pointed directly at the sun. This may cause lens or shutter curtain damage, color failure, ghosting on the image pickup device, or may possibly cause fires.
- Do not touch electric contacts on cameras and interchangeable lenses. Remember to attach the body cap when removing the lens.
- Before storing the camera for a long period, remove the battery. Select a cool, dry location for storage to prevent condensation or mold from forming inside the camera. After storage, test the camera by turning it on and pressing the shutter release button to make sure that it is operating normally.
- Always observe the operating environment restrictions described in the camera's manual.

LCD Monitor

- Do not push the monitor forcibly; otherwise the image may become vague, resulting in a playback mode failure or damage to the monitor.
- A strip of light may appear on the top/bottom of the monitor, but this is not a malfunction.
- When a subject is viewed diagonally in the camera, the edges may appear zigzagged on the monitor. This is not a malfunction; it will be less noticeable in playback mode.
- In places subject to low temperatures, the LCD monitor may take a long time to turn on or its color may change temporarily. When using the camera in extremely cold places, it is a good idea to occasionally place it in a warm place. An LCD monitor exhibiting poor performance due to low temperatures will recover in normal temperatures.
- The LCD used for the monitor is made with high-precision technology. However, black spots or bright spots of light may appear constantly on the LCD Monitor. Due to its characteristics or the angle at which you are viewing the monitor, the spot may not be uniform in color and brightness. This is not a malfunction.

Lens

- Do not immerse in water or splash with water.
- Do not drop or exert strong force on the lens.
- Do not hold at the moving part of the lens.
- Do not touch the lens surface directly.
- Do not touch the contact points directly.
- Do not subject to abrupt temperature changes.
- The operating temperature range is -10 °C - 40 °C (14 °F - 104 °F). Always use within this temperature range.

Legal and Other Notices

- Olympus makes no representations or warranties regarding any damages, or benefit expected by using this unit lawfully, or any request from a third person, which are caused by the inappropriate use of this product.
- Olympus makes no representations or warranties regarding any damages or any benefit expected by using this unit lawfully which are caused by erasing picture data.

Disclaimer of Warranty

- Olympus makes no representations or warranties, either expressed or implied, by or concerning any content of these written materials or software, and in no event shall be liable for any implied warranty of merchantability or fitness for any particular purpose or for any consequential, incidental or indirect damages (including but not limited to damages for loss of business profits, business interruption and loss of business information) arising from the use or inability to use these written materials or software or equipment. Some countries do not allow the exclusion or limitation of liability for consequential or incidental damages, so the above limitations may not apply to you.
- Olympus reserves all rights to this manual.

Warning

Unauthorized photographing or use of copyrighted material may violate applicable copyright laws. Olympus assumes no responsibility for unauthorized photographing, use or other acts that infringe upon the rights of copyright owners.

Copyright Notice

All rights reserved. No part of these written materials or this software may be reproduced or used in any form or by any means, electronic or mechanical, including photocopying and recording or the use of any type of information storage and retrieval system, without the prior written permission of Olympus. No liability is assumed with respect to the use of the information contained in these written materials or software, or for damages resulting from the use of the information contained therein. Olympus reserves the right to alter the features and contents of this publication or software without obligation or advance notice.

FCC Notice

- Radio and Television Interference
Changes or modifications not expressly approved by the manufacturer may void the user's authority to operate this equipment. This equipment has been tested and found to comply with the limits for a Class B digital device, pursuant to Part 15 of the FCC Rules. These limits are designed to provide reasonable protection against harmful interference in a residential installation. This equipment generates, uses, and can radiate radio frequency energy and, if not installed and used in accordance with the instructions, may cause harmful interference to radio communications. However, there is no guarantee that interference will not occur in a particular installation. If this equipment does cause harmful interference to radio or television reception, which can be determined by turning the equipment off and on, the user is encouraged to try to correct the interference by one or more of the following measures:
 - Adjust or relocate the receiving antenna.
 - Increase the distance between the camera and receiver.
 - Connect the equipment to an outlet on a circuit different from that to which the receiver is connected.
 - Consult your dealer or an experienced radio/TV technician for help. Only the OLYMPUS-supplied USB cable should be used to connect the camera to USB enabled personal computers (PC).

Any unauthorized changes or modifications to this equipment would void the user's authority to operate it.

Use Only Dedicated Rechargeable Battery and Battery Charger

We strongly recommend that you use only the genuine Olympus dedicated rechargeable battery and battery charger with this camera.

Using a non-genuine rechargeable battery and/or battery charger may result in fire or personal injury due to leakage, heating, ignition or damage to the battery. Olympus does not assume any liability for accidents or damage that may result from the use of a battery and/or battery charger that are not genuine Olympus accessories.

For customers in North and South America

For customers in USA

Declaration of Conformity

Model Number : E-5

Trade Name : OLYMPUS

Responsible Party : **OLYMPUS IMAGING AMERICA INC.**

Address : 3500 Corporate Parkway, P.O. Box 610, Center Valley,
PA 18034-0610, USA

Telephone Number : 484-896-5000

Tested To Comply With FCC Standards
FOR HOME OR OFFICE USE

This device complies with Part 15 of the FCC rules. Operation is subject to the following two conditions:

- (1) This device may not cause harmful interference.
- (2) This device must accept any interference received, including interference that may cause undesired operation.

For customers in CANADA

This Class B digital apparatus complies with Canadian ICES-003.

For customers in Europe



"CE" mark indicates that this product complies with the European requirements for safety, health, environment and customer protection. "CE" mark cameras are intended for sales in Europe.



This symbol [crossed-out wheeled bin WEEE Annex IV] indicates separate collection of waste electrical and electronic equipment in the EU countries.

Please do not throw the equipment into the domestic refuse.

Please use the return and collection systems available in your country for the disposal of this product.



This symbol [crossed-out wheeled bin Directive 2006/66/EC Annex II] indicates separate collection of waste batteries in the EU countries.

Please do not throw the batteries into the domestic refuse.

Please use the return and collection systems available in your country for the disposal of the waste batteries.

Provisions of warranty

1. If this product proves to be defective, although it has been used properly (in accordance with the written Handling Care and Operating instructions supplied with it), during the applicable national warranty period and has been purchased from an authorized Olympus distributor within the business area of Olympus Europa Holding GmbH as stipulated on the website: <http://www.olympus.com> this product will be repaired, or at Olympus's option replaced, free of charge. To claim under this warranty the customer must take the product before the end of the applicable national warranty period to the dealer where the product was purchased or any other Olympus service station within the business area of Olympus Europa Holding GmbH as stipulated on the website: <http://www.olympus.com>. During the one year period of the World Wide Guarantee the customer may turn the product in at any Olympus service station. Please notice that not in all countries such Olympus service station exists.
2. The customer shall transport the product to the dealer or Olympus authorized service station at his own risk and shall be responsible for any costs incurred in transporting the product.

Provisions of Guarantee

1. "OLYMPUS IMAGING CORP., Shinjuku Monolith, 2-3-1 Nishi-Shinjuku, Shinjuku-ku, Tokyo 163-0914, Japan grants a one year World Wide Guarantee. This worldwide Guarantee must be presented at an Olympus authorized repair service station before any repair can be made under conditions of this Guarantee. This Guarantee is valid only if the Guarantee Certificate and proof of purchase are presented at the Olympus repair service station. Please note that this Guarantee is in addition to and does not affect the customer's legal warranty rights under the applicable national legislation governing the sale of consumer goods mentioned above.
2. This Guarantee does not cover the following and the customer will be required to pay repair charge, even for defects occurring within the Guarantee period referred to above.
 - (a) Any defect that occurs due to mishandling (such as an operation performed that is not mentioned in the Handling Care or other sections of the instructions, etc.)
 - (b) Any defect that occurs due to repair, modification, cleaning, etc. performed by anyone other than Olympus or an Olympus authorized service station.
 - (c) Any defect or damage that occurs due to transport, a fall, shock, etc. after purchase of the product.
 - (d) Any defect or damage that occurs due to fire, earthquake, flood damage, thunderbolt, other natural disasters, environmental pollution and irregular voltage sources.
 - (e) Any defect that occurs due to careless or improper storage (such as keeping the product under conditions of high temperature and humidity, near insect repellents such as naphthalene or harmful drugs, etc.), improper maintenance, etc.
 - (f) Any defect that occurs due to exhausted batteries, etc.
 - (g) Any defect that occurs due to sand, mud, etc. entering the inside of the product casing.
 - (h) When the Guarantee Certificate is not returned with the product.
 - (i) When any alterations whatsoever are made to the Guarantee Certificate regarding the year, month and date of purchase, the customer's name, the dealer's name, and the serial number.
 - (j) When proof of purchase is not presented with this Guarantee Certificate.
3. This Guarantee applies to the product only; the Guarantee does not apply to any other accessory equipment, such as the case, strap, lens cap and batteries.
4. Olympus's sole liability under this Guarantee shall be limited to repairing or replacing the product. Any liability under the Guarantee for indirect or consequential loss or damage of any kind incurred or suffered by the customer due to a defect of the product, and in particular any loss or damage caused to any lenses, films, other equipment or accessories used with the product or for any loss resulting from a delay in repair or loss of data, is excluded. Compelling regulations by law remain unaffected by this.

Notes regarding Guarantee maintenance

1. This Guarantee will only be valid if the Guarantee Certificate is duly completed by Olympus or an authorized dealer or other documents contain sufficient proof. Therefore, please make sure that your name, the name of the dealer, the serial number and the year, month and date of purchase are all completed or the original invoice or the sales receipt (indicating the dealer's name, the date of purchase and product type) is attached to this Guarantee Certificate. Olympus reserves the right to refuse free-of-charge service if neither Guarantee Certificate is completed nor the above document is attached or if the information contained in it is incomplete or illegible.
2. Since this Guarantee Certificate will not be re-issued, keep it in a safe place.
 - Please refer to the list on the web site: <http://www.olympus.com> for the authorized international Olympus service network.

Trademarks

- IBM is a registered trademark of International Business Machines Corporation.
- Microsoft and Windows are registered trademarks of Microsoft Corporation.
- Macintosh is a trademark of Apple Inc.
- SDXC logo and SDHC logo are trademarks.
- "Shadow Adjustment Technology" function contains patented technologies from Apical Limited.



























- Four Thirds and the Four Thirds logo are trademarks or registered trademarks of OLYMPUS IMAGING Corporation in Japan, the United States, the countries of the European Union, and other countries.
- All other company and product names are registered trademarks and/or trademarks of their respective owners.
- The standards for camera file systems referred to in this manual are the "Design Rule for Camera File System/DCF" standards stipulated by the Japan Electronics and Information Technology Industries Association (JEITA).

Index

Symbols	
	107
	112
	109, 150
	99
CONTROL SETTINGS	109
	102, 148
FUNCTION	107
	108
	147
	114
	146
	147
	120
	106
	102
	103
	80
	112
	112
	109
	99, 152
	102
BUTTON/DIAL	104
	108
	108
	111
	112
	113
	115
	117
	117
	107
4 h TIMER	111
A	
AA BATTERY TYPE	119
Adding sound to still pictures	94
Adobe RGB	114
AE BKT	49
AE bracketing	49
AE lock	48
AEL/AFL	105
AEL/AFL MEMO	106
AEL Metering	111
AF AREA	57
AF AREA POINTER	103
AF AREA SELECT	107
AF FOCUS ADJ.	118
AF ILLUMINAT. (AF Illuminator)	103
AF MODE	53
AF SENSITIVITY	103
AF target mode	58
AF target	56
ALL	113
ALL ERASE	98
All target AF mode	56
ANTI-SHOCK	59, 62, 112
Aperture priority shooting A	42
Aperture value	15, 41, 42
ASPECT	93
ASPECT SHOOTING	115
Auto flash	73
Auto focus	131
Auto white balance	66
B	
B (Basic)	64
B&W FILTER	71
BACKLIT LCD	109
Battery	10, 137
BGM	90
BLACK & WHITE	93
BULB FOCUSING	102
Bulb shooting	45, 61
BULB TIMER	112
BUTTON FUNCTION	106
BUTTON TIMER	107
C	
C-AF (continuous AF)	54
C-AF LOCK	103
C-AF+MF	55
Calendar display	88
CARD SETUP	98, 136
Cards	12, 136
Center weighted averaging metering	47
	116
	116
CLEANING MODE	135
Close-up playback Q	86
COLOR SPACE	114
Color temperature	143
Compact Flash	12, 136
Compression rate	64
Continuous AF (C-AF)	54
CONTRAST	71
CONTROL	110
Control panel	5
COPY ALL	96
COPYRIGHT SETTINGS	117
CROSS PROCESS	71
Custom printing	125
Custom white balance CWB	66
D	
Date/time setting	14
DIAL DIRECTION	104
DIAL FUNCTION	104
Digital ESP metering	46

Dioptr adjustment	13	ISO STEP	111
DIORAMA	71	ISO-AUTO	112
Direct print	123	ISO-AUTO SET	111
dpi SETTING	116	J	
DPOF	121	JPEG EDIT	93
DRAMATIC TONE	71	L	
Dust reduction	13, 134	L (Large)	64
Dynamic-single target AF mode	56	Lens	11, 138
E		LEVEL ADJUST	120
EDIT FILENAME	116	LEVEL GAUGE	107, 110
e-PORTRAIT	93	Light box display	87
EV STEP	111	LIGHT TONE	71
Exposure compensation	47	Lithium ion battery	10, 137
EXPOSURE SHIFT	117	Lithium ion charger	10, 137
EXT. WB DETECT	117	Live control	37
Eyepiece shutter	60	LIVE PREVIEW	46, 106
F		Live view	35
F (Fine)	64	LIVE VIEW BOOST	109
FACE DETECT	38, 109	LOW KEY	71
FILE NAME	116	M	
Fill-in flash	74	M (Middle)	64
FIRMWARE	100	MAGNIFY	107
FL BKT	77	Manual flash	75
Flash bracketing	77	Manual focus (MF)	38, 54
Flash intensity control	76	Manual shooting M	44
Flash mode	73	METERING	46
Flash off	74	MF	106
Fn FACE DETECT	38, 106	MF (manual focus)	54
FOCUS RING	103	MF ASSIST	103
FORMAT	136	Monitor brightness adjustment	99
Four Thirds system lenses	138	MONOTONE	71
G		MOVIE	84, 117
GENTLE SEPIA	71	MOVIE PLAY	85
GRAINY FILM	71	MTP	110, 129
H		Multi view display	40
HD	84	MULTIPLE EXPOSURE	51
HDMI	92, 108	MUTED	71
HDMI CONTROL	93, 108	MYSET	100
HDMI OUT	108	MYSET shooting	106
HIGH KEY	71	N	
Histogram	39, 89	N (Normal)	64
HISTOGRAM SETTINGS	109	NATURAL	71
Home position	58	NOISE FILTER	72, 113
I		NOISE REDUCT.	72, 113
[i]b	127	NTSC	108
i- ENHANCE	71	Number of pixels	64
IMAGE ASPECT	65	O	
IMAGE OVERLAY	52	OLYMPUS Viewer 2	127
Index display	88	Olympus wireless RC flash system	80
Information display	39, 89	One-touch white balance	69, 106
IS MODE (IS)	107	P	
ISO	50	PAL	108
ISO BKT	51	PALE&LIGHT COLOR	71
ISO bracketing	51	PD AFL	103

PICT. TONE	71	Single AF (S-AF)	53
PictBridge	123	Single target AF mode [•]	56
Picture	70	Single-frame copy	96
PICTURE MODE	70	Single-frame erase 	98
PICTURE MODE SETTINGS	111	Single-frame playback	86
PIN HOLE 	71	Single-frame protect	97
Pixel count	64, 114	Single-frame shooting 	59
PIXEL MAPPING	135	SLEEP	108
POP ART 	71	SLIDE	90
PORTRAIT 	71	Slideshow 	90
Preset white balance	66	Slow synchronization  SLOW	73
PREVIEW	46, 106	Slow synchronization  SLOW2	74
PRINT	110	Small-single target AF mode [•]s	56, 103
Print reservation	121	SOFT FOCUS 	71
PRIORITY SET	116	Spot metering - highlight control  H !	47
Program shift Ps	41	Spot metering - shadow control  SH	47
Program shooting P	41	Spot metering 	47
Protecting Om	97	sRGB	114
Q		STORAGE	110
QUICK ERASE	115	Strap	9
R		Super control panel	6, 21
RAW	64	Super FP flash	79
RAW DATA EDIT	93	T	
RAW+JPEG ERASE	115	TEST PICTURE	106
RAW 	106	Trimming 	93, 126
REC VIEW	99	U	
Record mode 	64, 84, 144	USB MODE	110
REDEYE FIX	93	V	
Red-eye reduction flash 	73	VIDEO OUT	108
Remote control 	60	Viewfinder	4, 13, 15
RESET	101	VIVID 	71
RESET LENS	102	VOLUME	109
RESET PROTECT	97	W	
RESET/MYSET	100	WB	67
Resizing 	93	WB BKT	69
RLS PRIORITY C	108	WB compensation	68
RLS PRIORITY S	108	White balance bracketing	69
Rotating images 	91	White balance sensor	67
S		White balance WB	66
 (Small)	64	Z	
S-AF (single AF)	53	Zoom display	40
S-AF+MF	55	Zoom frame AF	40
SATURATION	71, 93	ZUIKO DIGITAL interchangeable lens	138
SD	84		
SD/SDHC/SDXC card	12, 136		
Self-timer 	60		
SEPIA	93		
Sequential shooting H 	59		
Sequential shooting L 	59		
SF (Super Fine)	64		
SHADING COMP.	114		
SHADOW ADJ	93		
SHARPNESS	71		
Shutter priority shooting S	43		
Shutter speed	15, 41, 43		

OLYMPUS®

<http://www.olympus.com/>

OLYMPUS IMAGING CORP.

Shinjuku Monolith, 3-1 Nishi-Shinjuku 2-chome, Shinjuku-ku, Tokyo, Japan

OLYMPUS IMAGING AMERICA INC.

3500 Corporate Parkway, P.O. Box 610, Center Valley, PA 18034-0610, U.S.A. Tel. 484-896-5000

Technical Support (U.S.A.)

24/7 online automated help: <http://www.olympusamerica.com/DSLR>

Phone customer support: Tel. 1-800-260-1625 (Toll-free)

Our phone customer support is available from 9am to 9pm (Monday to Friday) ET
E-Mail: e-slrpro@olympus.com

Olympus software updates can be obtained at: <http://www.olympusamerica.com/digital>

To find the nearest Service Centers, please visit: <http://www.olympusamerica.com/digital>,
and click on the Worldwide Warranty icon at the bottom of the page.

Service Centers

U.S.A.:

California

Olympus Imaging America Inc.

10805 Holder Street Suite 170

Cypress, CA 90630-5145

Tel: (800) 260-1625

FAX: (714) 229-1652

New York

Olympus Imaging America Inc.

400 Rabro Drive

Hauppauge, NY 11788-4258

Tel: (800) 260-1625

FAX: (631) 881-6510

Canada:

Ontario

Olympus Canada Inc.

Consumer Products Group

151 Telson Road

Markham, Ontario Canada L3R 1E7

Tel: (800) 260-1625

Fax: (905) 969-3291

Mexico:

Olympus Imaging de Mexico S.A. de C.V.

WTC Mexico, Montecito

No.38 - planta baja local 12

Col. Napoles, Mexico D.F. 03810

Tel: (01800) 900-1280/900-1281