

Nikon

DIGITAL CAMERA

D90

User's Manual

En

Where to Find It

Find what you're looking for from:

 **The Table of Contents** → pp. viii–xiii

Find items by function or menu name.

 **The Q&A Index** → pp. iv–vii

Know what you want to do but don't know the function name? Find it from the "question and answer" index.

 **The Index** → pp. 276–278

Search by key word.

 **Error Messages** → pp. 255–257

If a warning is displayed in the control panel, viewfinder, or monitor, find the solution here.

 **Troubleshooting** → pp. 250–254

Camera behaving unexpectedly? Find the solution here.

For Your Safety

Before using the camera for the first time, read the safety instructions in "For Your Safety" (pg. xiv).

Help

Use the camera's on-board help feature for help on menu items and other topics. See page 21 for details.

Digitutor

"Digitutor", a series of "watch and learn" manuals in movie form, is available from the following website: http://www.nikondigitutor.com/index_eng.html

Package Contents

Be sure all items listed here were included with your camera. *Memory cards are sold separately.*

- ❑ D90 digital camera (pg. 3)



- ❑ Body cap (pp. 3, 240)



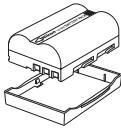
- ❑ BM-10 LCD monitor cover (pg. 17)



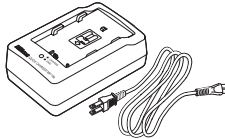
- ❑ DK-5 eyepiece cap (pg. 17)



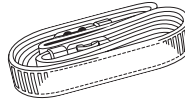
- ❑ EN-EL3e rechargeable Li-ion battery with terminal cover (pp. 22, 23)



- ❑ MH-18a quick charger with power cable (pg. 22)



- ❑ AN-DC1 strap (pg. 17)



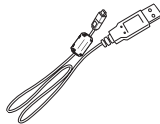
- ❑ BS-1 accessory shoe cover (pg. 233)



- ❑ EG-D2 audio/video cable (pg. 146)



- ❑ UC-E4 USB cable (pp. 149, 151)



- ❑ Warranty
- ❑ *User's Manual* (this guide)
- ❑ *Quick Guide* (a guide for first-time users describing the basic steps involved in such tasks taking pictures, copying pictures to a computer, and printing pictures)
- ❑ *Software Installation Guide*
- ❑ Software Suite CD-ROM
- ❑ Registration card (U. S. A. only)

Symbols and Conventions

To make it easier to find the information you need, the following symbols and conventions are used:



This icon marks cautions; information that should be read before use to prevent damage to the camera.



This icon marks notes; information that should be read before using the camera.

Trademark Information

Macintosh, Mac OS, and QuickTime are registered trademarks of Apple Inc. Microsoft, Windows and Windows Vista are either registered trademarks, or trademarks of Microsoft Corporation in the United States and/or other countries. The SD logo is a trademark of the SD Card Association. PictBridge and the SDHC logo are trademarks. HDMI, the HDMI logo and High-Definition Multimedia Interface are trademarks or registered trademarks of HDMI Licensing LLC. All other trade names mentioned in this manual or the other documentation provided with your Nikon product are trademarks or registered trademarks of their respective holders.



Introduction



Basic Photography and Playback



More on Photography (All Modes)



P, S, A, and M Modes



More on Playback



Connections



The Playback Menu



The Shooting Menu



Custom Settings



The Setup Menu



The Retouch Menu



Recent Settings / My Menu



Technical Notes

Q&A Index

Find what you're looking for using this "question and answer" index.

New Features

Question	Key phrase	See page
Can I use the monitor as a viewfinder?	Live view	43
How do I shoot movies?	Recording movies	50
Can I control how photos are processed?	Picture Controls	108
How do I preserve details in shadows and highlights?	Active D-Lighting	119
How do I keep the subject in focus when changing the composition?	3D-tracking	173
How do I remove dust from the low-pass filter protecting the image sensor?	Clean Image Sensor	203

Frequently-Asked Questions

Question	Key phrase	See page
How do I use the menus?	Using the menus	18
How do I get more information on a menu?	Help	21
Can I get quick access to frequently-used settings?	My Menu	225
Can I get quick access to recently-used settings?	Recent settings	224
What do these indicators mean?	Control panel, viewfinder	7, 9
What does this warning mean?	Error messages and displays	255
How many more shots can I take with this card?	Number of exposures remaining	35
How much charge does the battery have left?	Battery level	34
What does "exposure" mean and how does it work?	Exposure	79
What do I do with the viewfinder eyepiece cap?	Self timer, remote control	66, 68
What optional flash units (Speedlights) can I use?	Optional flash units	233
What lenses can I use?	Lenses	228
What accessories are available for my camera?	Accessories	239
What memory cards can I use?	Approved memory cards	242
What software is available for my camera?	Accessories	240
Who can I ask to repair or inspect my camera?	Servicing the camera	247
How do I clean the camera or lens?	Cleaning the camera	243

Camera Setup

Question	Key phrase	See page
How do I stop parts of my photos from blinking?	Photo info, highlights	131, 163
How do I focus the viewfinder?	Viewfinder focus	32
How do I keep the monitor from turning off?	Monitor off	180
How do I set the clock?	World time	204
How do I set the clock for daylight saving time?		
How do I change time zones when I travel?		
How do I adjust monitor brightness?	LCD brightness	202
How do I restore default settings?	Two-button reset	75
How do I turn off the light on the front of the camera?	AF-assist illuminator	174
Can I display a framing grid in the viewfinder?	Grid display	181
How do I view the control panel in the dark?	LCD illuminator	8, 196
How do I keep the shutter speed and aperture displays from turning off?	Auto meter off	35, 179
How do I change the self timer delay?	Self timer	66, 179
How do I change the remote delay?	Remote control	68, 180
How do I keep the camera from beeping?	Beep	180
Can I display the menus in a different language?	Language	204
How do I keep the file number from being reset when I insert a new memory card?	File number sequence	182
How do I reset file numbering to 1?		

Taking Photographs

Question	Key phrase	See page
Is there an easy way to take snapshots?	Auto mode	34
Is there an easy way to take more creative shots?	Scene modes	41
Can I take pictures without the flash?	Ⓜ mode	34
	Flash mode	71
	ISO sensitivity	74
How do I bring out a portrait subject?	Portrait mode	41
How can I get good landscape shots?	Landscape mode	41
How do I take close ups of small objects?	Close-up mode	42
How do I “freeze” a moving subject?	Sports mode	42
Can I include night backgrounds in my portraits?	Night portrait mode	42
How do I take a lot of photographs quickly?	Release mode	64
Can I shoot a self-portrait?	Self timer	66
Is there a remote control for this camera?	Remote control	68
How do I adjust exposure?	P, S, A, and M modes	78
How do I freeze or blur moving objects?	Mode S (shutter-priority auto)	81
How do I blur background details?	Mode A (aperture-priority auto)	82
Can I make photos brighter or darker?	Exposure compensation	90
How do I make a time exposure?	Long time-exposures	85
How do I use the flash?	Flash photography	70
Can the flash fire automatically when needed?	Flash mode	70
How do I keep the flash from firing?		
How do I prevent red eye?	Red-eye reduction	71
Can I control how the camera focuses?	Autofocus	54
How do I focus on a moving subject?	Autofocus mode	54
How do I choose where the camera focuses?	Focus point	56
Can I change the composition after focusing?	Focus lock	57
Can I create a multiple exposure?	Multiple exposure	121
How do I improve image quality?	Image quality and size	62, 63
How do I take bigger photographs?		
How can I get more photos on the memory card?		
Can I take photos at a reduced size for e-mail?		

Viewing and Retouching Photographs

Question	Key phrase	See page
Can I view my photographs on the camera?	Camera playback	48, 128
Can I view more information about photos?	Photo info	129
How do I get rid of an unwanted photo?	Deleting individual photos	49, 140, 162
Can I delete several photos at once?	Delete	162
Can I zoom in on pictures to make sure they're in focus?	Playback zoom	138
Can I protect photos from accidental deletion?	Protect	139
Is there an automatic playback ("slide show") option?	Pictmotion Slide show	141, 143
Can I view my photos on TV?	Television playback	146
Can I view my photos in High Definition?	HDMI	147
How do I copy photos to my computer?	Connecting to a computer	148
How do I print photographs?	Printing photographs	150
Can I print photos without a computer?	Printing via USB	151
Can I print the date on my photographs?	Time stamp, DPOF	152, 155
How do I order professional prints?	Print set (DPOF)	157
How do I bring out details in shadows?	D-Lighting	212
Can I get rid of red eye?	Red-eye correction	212
Can I crop photographs on the camera?	Trim	213
Can I create a monochrome copy of a photograph?	Monochrome	214
Can I create a copy with different colors?	Filter effects	215
How do I adjust existing colors?	Color balance	216
Can I make a small copy of a photograph?	Small picture	216
Can I overlay two photos to make a single image?	Image overlay	218
Can I use the camera to create JPEG copies of NEF (RAW) photographs?	NEF (RAW) processing	220
Is there a quick way to retouch photographs?	Quick retouch	221
Can I straighten photographs?	Straighten	221
How do I reduce distortion?	Distortion control	222
Can I create the effect of a fisheye lens?	Fisheye	222
Can I compare retouched copies with the originals?	Side-by-side comparison	223






Table of Contents

Q&A Index	iv
For Your Safety	xiv
Notices.....	xvi

Introduction **1**

Overview	2
Getting to Know the Camera.....	3
The Camera Body	3
The Mode Dial.....	6
The Control Panel.....	7
The Viewfinder.....	9
The Shooting Information Display	10
The Command Dials	13
Attaching the AN-DC1 Camera Strap.....	17
The BM-10 Monitor Cover	17
The DK-21 Viewfinder Eyepiece Cup.....	17
Camera Menus.....	18
Using Camera Menus	19
Help	21
First Steps	22
Charge the Battery	22
Insert the Battery	23
Attach a Lens.....	25
Basic Setup.....	27
Inserting Memory Cards.....	29
Adjust Viewfinder Focus	32

Basic Photography and Playback **33**

“Point-and-Shoot” Photography ( and  Modes).....	34
Step 1: Turn the Camera On.....	34
Step 2: Choose Shooting and Focus Modes	36
Step 3: Check Camera Settings.....	36
Step 4: Frame the Photograph	37
Step 5: Focus	38
Step 6: Shoot.....	39
Creative Photography (Scene Modes)	41
 Portrait.....	41
 Landscape.....	41
 Close Up	42

🏆 Sports.....	42
📷 Night Portrait	42
Framing Pictures in the Monitor (Live View).....	43
Basic Playback.....	48
Deleting Unwanted Photographs.....	49
Recording and Viewing Movies (Live View)	50

More on Photography (All Modes) 53

Focus	54
Autofocus	54
Focus Point Selection	56
Focus Lock.....	57
Manual Focus	59
Image Quality and Size	61
Image Quality	62
Image Size.....	63
Release Mode.....	64
Continuous Mode.....	65
Self-Timer Mode (⏱)	66
Using an Optional Remote Control (Ⓜ).....	68
Using the Built-in Flash.....	70
Flash Mode	71
ISO Sensitivity.....	74
Two-Button Reset	75

P, S, A, and M Modes 77

Shutter Speed and Aperture.....	78
Mode P (Programmed Auto)	80
Mode S (Shutter-Priority Auto)	81
Mode A (Aperture-Priority Auto).....	82
Mode M (Manual).....	83
Exposure	87
Metering.....	87
Autoexposure Lock (P, S, and A Modes Only).....	88
Exposure Compensation.....	90
Flash Compensation	91
Exposure and Flash Bracketing.....	92
White Balance	95
Fine-Tuning White Balance	97
Choosing a Color Temperature.....	99
Preset Manual.....	100

Picture Controls.....	108
Selecting Nikon Picture Controls.....	109
Modifying Existing Picture Controls.....	110
Creating Custom Picture Controls.....	113
Sharing Custom Picture Controls.....	115
Managing Custom Picture Controls.....	117
Active D-Lighting.....	119
Multiple Exposure.....	121
The GP-1 GPS Unit.....	124

More on Playback **127**




Full-Frame Playback.....	128
Photo Information.....	129
Thumbnail Playback.....	135
Calendar Playback.....	136
Taking a Closer Look: Playback Zoom.....	138
Protecting Photographs from Deletion.....	139
Deleting Individual Photographs.....	140
Pictmotion.....	141
Slide Shows.....	143




Connections **145**

Viewing Photographs on TV.....	146
Standard Definition Devices.....	146
High-Definition Devices.....	147
Connecting to a Computer.....	148
Before Connecting the Camera.....	148
Connecting the Camera.....	149
Printing Photographs.....	150

Menu Guide **159**

▶ The Playback Menu: Managing Images.....	160
Selecting Multiple Pictures.....	160
Delete.....	162
Playback Folder.....	162
Hide Image.....	162
Display Mode.....	163
Image Review.....	163
Rotate Tall.....	163
Pictmotion.....	163







Slide Show.....	164
Print Set (DPOF)	164
 The Shooting Menu: Shooting Options.....	165
Set Picture Control.....	165
Manage Picture Control.....	165
Image Quality	165
Image Size.....	165
White Balance.....	165
ISO Sensitivity Settings.....	166
Active D-Lighting	166
Color Space.....	167
Long Exp. NR (Long Exposure Noise Reduction)	167
High ISO NR.....	168
Active Folder	169
Multiple Exposure	170
Movie setting.....	170
 Custom Settings: Fine-Tuning Camera Settings.....	171
 Reset Custom Settings	172
a: Autofocus	173
a1: AF-area Mode.....	173
a2: Center Focus Point.....	174
a3: Built-in AF-assist Illuminator.....	174
a4: AF Point Illumination	175
a5: Focus Point Wrap-Around.....	175
a6: AE-L/AF-L for MB-D80.....	176
a7: Live View Autofocus.....	176
b: Metering/Exposure.....	177
b1: EV Steps for Exposure Cntrl.	177
b2: Easy Exposure Compensation	177
b3: Center-Weighted Area	178
b4: Fine Tune Optimal Exposure.....	178
c: Timers/AE Lock	179
c1: Shutter-Release Button AE-L	179
c2: Auto Meter-off Delay	179
c3: Self-Timer.....	179
c4: Monitor off Delay.....	180
c5: Remote on Duration.....	180
d: Shooting/Display.....	180
d1: Beep	180
d2: Viewfinder Grid Display	181
d3: ISO Display and Adjustment.....	181
d4: Viewfinder Warning Display.....	181
d5: Screen Tips.....	182
d6: CL Mode Shooting Speed	182
d7: File Number Sequence.....	182
d8: Shooting Info Display	183

d9: LCD Illumination	183
d10: Exposure Delay Mode	183
d11: Flash Warning	183
d12: MB-D80 Battery Type	184
e: Bracketing/Flash	185
e1: Flash Shutter Speed	185
e2: Flash Cntrl for Built-in Flash	185
e3: Modeling Flash	191
e4: Auto Bracketing Set	191
e5: Auto FP	195
e6: Bracketing Order	195
f: Controls	196
f1:  Switch	196
f2: OK Button (Shooting Mode)	196
f3: Assign FUNC. Button	197
f4: Assign AE-L/AF-L Button	200
f5: Customize Command Dials	201
f6: No Memory Card?	201
f7: Reverse Indicators	201
 The Setup Menu: Camera Setup	202
Format Memory Card	202
LCD Brightness	202
Clean Image Sensor	203
Lock Mirror up for Cleaning	203
Video Mode	203
HDMI	203
World Time	204
Language	204
Image Comment	205
Auto Image Rotation	205
Image Dust off Ref Photo	206
Battery Info	208
GPS	208
Eye-Fi Upload	208
Firmware Version	208
 The Retouch Menu: Creating Retouched Copies	209
Creating Retouched Copies	210
D-Lighting	212
Red-Eye Correction	212
Trim	213
Monochrome	214
Filter Effects	215
Color Balance	216
Small Picture	216
Image Overlay	218
NEF (RAW) Processing	220
Quick Retouch	221

Straighten	221
Distortion Control	222
Fisheye	222
Side-by-Side Comparison.....	223
☰ Recent Settings/☰ My Menu	224
☰ Recent Settings: Viewing Recent Settings	224
☰ My Menu: Creating a Custom Menu	225

Technical Notes

227

Compatible Lenses.....	228
Compatible CPU Lenses	229
Non-CPU Lenses	230
Optional Flash Units (Speedlights)	233
The Nikon Creative Lighting System (CLS)	233
Flash Contacts	238
Other Accessories	239
Caring for the Camera	243
Storage.....	243
Cleaning	243
The Low-Pass Filter	244
Caring for the Camera and Battery: Cautions	248
Troubleshooting	250
Display	250
Shooting (All Modes).....	251
Shooting (AUTO,  ,  ,  ,  ,  , and  modes)	252
Shooting (P, S, A, M).....	252
Playback	253
Miscellaneous.....	254
Error Messages.....	255
Appendix	258
Available Settings and Defaults.....	258
Memory Card Capacity	262
Exposure Program	263
Bracketing Programs	264
Flash Control.....	265
Shutter Speeds Available with the Built-in Flash	265
Aperture, Sensitivity, and Flash Range.....	266
Specifications	267
Index.....	276

For Your Safety

To prevent damage to your Nikon product or injury to yourself or to others, read the following safety precautions in their entirety before using this equipment. Keep these safety instructions where all those who use the product will read them.

The consequences that could result from failure to observe the precautions listed in this section are indicated by the following symbol:



This icon marks warnings. To prevent possible injury, read all warnings before using this Nikon product.

■ ■ WARNINGS

Keep the sun out of the frame

Keep the sun well out of the frame when shooting backlit subjects. Sunlight focused into the camera when the sun is in or close to the frame could cause a fire.

Do not look at the sun through the viewfinder

Viewing the sun or other strong light source through the viewfinder could cause permanent visual impairment.

Using the viewfinder diopter control

When operating the viewfinder diopter control with your eye to the viewfinder, care should be taken not to put your finger in your eye accidentally.

Turn off immediately in the event of malfunction

Should you notice smoke or an unusual smell coming from the equipment or AC adapter (available separately), unplug the AC adapter and remove the battery immediately, taking care to avoid burns. Continued operation could result in injury. After removing the battery, take the equipment to a Nikon-authorized service center for inspection.

Do not disassemble

Touching the product's internal parts could result in injury. In the event of malfunction, the product should be repaired only by a qualified technician. Should the product break open as the result of a fall or other accident, remove the battery and/or AC adapter and then take the product to a Nikon-authorized service center for inspection.

Do not use in the presence of flammable gas

Do not use electronic equipment in the presence of flammable gas, as this could result in explosion or fire.

Keep out of reach of children

Failure to observe this precaution could result in injury.

Do not place the strap around the neck of an infant or child

Placing the camera strap around the neck of an infant or child could result in strangulation.

Observe caution when using the flash

- Using the camera with the flash in close contact with the skin or other objects could cause burns.
- Using the flash close to the subject's eyes could cause temporary visual impairment. Particular care should be observed when photographing infants, when the flash should be no less than one meter (39 in.) from the subject.

⚠ Observe proper precautions when handling batteries

Batteries may leak or explode if improperly handled. Observe the following precautions when handling batteries for use in this product:

- Use only batteries approved for use in this equipment.
- Do not short or disassemble the battery.
- Be sure the product is off before replacing the battery. If you are using an AC adapter, be sure it is unplugged.
- Do not attempt to insert the battery upside down or backwards.
- Do not expose the battery to flame or to excessive heat.
- Do not immerse in or expose to water.
- Replace the terminal cover when transporting the battery. Do not transport or store the battery with metal objects such as necklaces or hairpins.
- Batteries are prone to leakage when fully discharged. To avoid damage to the product, be sure to remove the battery when no charge remains.
- When the battery is not in use, attach the terminal cover and store in a cool, dry place.
- The battery may be hot immediately after use or when the product has been used on battery power for an extended period. Before removing the battery turn the camera off and allow the battery to cool.
- Discontinue use immediately should you notice any changes in the battery, such as discoloration or deformation.

⚠ Observe proper precautions when handling the quick charger

- Keep dry. Failure to observe this precaution could result in fire or electric shock.
- Dust on or near the metal parts of the plug should be removed with a dry cloth. Continued use could result in fire.
- Do not handle the power cable or go near the charger during thunderstorms. Failure to observe this precaution could result in electric shock.
- Do not damage, modify, or forcibly tug or bend the power cable. Do not place it under heavy objects or expose it to heat or flame. Should the insulation be damaged and the wires become exposed, take the power cable to a Nikon-authorized service representative for inspection. Failure to observe this precaution could result in fire or electric shock.
- Do not handle the plug or charger with wet hands. Failure to observe this precaution could result in electric shock.

⚠ Use appropriate cables

When connecting cables to the input and output jacks, use only the cables provided or sold by Nikon for the purpose to maintain compliance with product regulations.

⚠ CD-ROMs

CD-ROMs containing software or manuals should not be played back on audio CD equipment. Playing CD-ROMs on an audio CD player could cause hearing loss or damage the equipment.

⚠ Avoid contact with liquid crystal

Should the monitor break, care should be taken to avoid injury due to broken glass and to prevent the liquid crystal from the monitor touching the skin or entering the eyes or mouth.

Notices

- No part of the manuals included with this product may be reproduced, transmitted, transcribed, stored in a retrieval system, or translated into any language in any form, by any means, without Nikon's prior written permission.
- Nikon reserves the right to change the specifications of the hardware and software described in these manuals at any time and without prior notice.
- Nikon will not be held liable for any damages resulting from the use of this product.
- While every effort has been made to ensure that the information in these manuals is accurate and complete, we would appreciate it were you to bring any errors or omissions to the attention of the Nikon representative in your area (address provided separately).

Notices for Customers in the U.S.A.

Federal Communications Commission (FCC) Radio Frequency Interference Statement

This equipment has been tested and found to comply with the limits for a Class B digital device, pursuant to Part 15 of the FCC rules. These limits are designed to provide reasonable protection against harmful interference in a residential installation. This equipment generates, uses, and can radiate radio frequency energy and, if not installed and used in accordance with the instructions, may cause harmful interference to radio communications. However, there is no guarantee that interference will not occur in a particular installation. If this equipment does cause harmful interference to radio or television reception, which can be determined by turning the equipment off and on, the user is encouraged to try to correct the interference by one or more of the following measures:

- Reorient or relocate the receiving antenna.
- Increase the separation between the equipment and receiver.
- Connect the equipment into an outlet on a circuit different from that to which the receiver is connected.
- Consult the dealer or an experienced radio/television technician for help.



CAUTIONS

Modifications

The FCC requires the user be notified that any changes or modifications made to this device that are not expressly approved by Nikon Corporation may void the user's authority to operate the equipment.

Interface Cables

Use the interface cables sold or provided by Nikon for your equipment. Using other interface cables may exceed the limits of Class B Part 15 of the FCC rules.

Notice for Customers in the State of California

WARNING: Handling the cord on this product may expose you to lead, a chemical known to the State of California to cause birth defects or other reproductive harm. *Wash hands after handling.*

Nikon Inc., 1300 Walt Whitman Road,
Melville, New York 11747-3064, U.S.A.
Tel.: 631-547-4200

Notices for Customers in Canada

CAUTION

This Class B digital apparatus complies with Canadian ICES-003.

Symbol for Separate Collection in European Countries

This symbol indicates that this product is to be collected separately.

The following apply only to users in European countries:

- This product is designated for separate collection at an appropriate collection point. Do not dispose of as household waste.
- For more information, contact the retailer or the local authorities in charge of waste management.



Notice Concerning Prohibition of Copying or Reproduction

Note that simply being in possession of material that has been digitally copied or reproduced by means of a scanner, digital camera, or other device may be punishable by law.

• Items prohibited by law from being copied or reproduced

Do not copy or reproduce paper money, coins, securities, government bonds, or local government bonds, even if such copies or reproductions are stamped "Sample."

The copying or reproduction of paper money, coins, or securities which are circulated in a foreign country is prohibited.

Unless the prior permission of the government has been obtained, the copying or reproduction or unused postage stamps or post cards issued by the government is prohibited.

The copying or reproduction of stamps issued by the government and of certified documents stipulated by law is prohibited.

• Cautions on certain copies and reproductions

The government has issued cautions on copies or reproductions of securities issued by private companies (shares, bills, checks, gift certificates, etc.), commuter passes, or coupon tickets, except when a minimum of necessary copies are to be provided for business use by a company. Also, do not copy or reproduce passports issued by the government, licenses issued by public agencies and private groups, ID cards, and tickets, such as passes and meal coupons.

ATTENTION

Cet appareil numérique de la classe B est conforme à la norme NMB-003 du Canada.

• Comply with copyright notices

The copying or reproduction of copyrighted creative works such as books, music, paintings, woodcuts, prints, maps, drawings, movies, and photographs is governed by national and international copyright laws. Do not use this product for the purpose of making illegal copies or to infringe copyright laws.

Disposing of Data Storage Devices

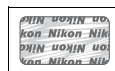
Please note that deleting images or formatting memory cards or other data storage devices does not completely erase the original image data. Deleted files can sometimes be recovered from discarded storage devices using commercially available software, potentially resulting in the malicious use of personal image data. Ensuring the privacy of such data is the user's responsibility.

Before discarding a data storage device or transferring ownership to another person, erase all data using commercial deletion software, or format the device and then completely refill it with images containing no private information (for example, pictures of empty sky). Be sure to also replace any pictures selected for preset manual. Care should be taken to avoid injury when physically destroying data storage devices.

Use Only Nikon Brand Electronic Accessories

Nikon cameras are designed to the highest standards and include complex electronic circuitry. Only Nikon brand electronic accessories (including battery chargers, batteries, AC adapters, and flash accessories) certified by Nikon specifically for use with this Nikon digital camera are engineered and proven to operate within the operational and safety requirements of this electronic circuitry.

The use of non-Nikon electronic accessories could damage the camera and may void your Nikon warranty. The use of third-party rechargeable Li-ion batteries not bearing the Nikon holographic seal shown at right could interfere with normal operation of the camera or result in the batteries overheating, igniting, rupturing, or leaking.



For more information about Nikon brand accessories, contact a local authorized Nikon dealer.

Before Taking Important Pictures

Before taking pictures on important occasions (such as at weddings or before taking the camera on a trip), take a test shot to ensure that the camera is functioning normally. Nikon will not be held liable for damages or lost profits that may result from product malfunction.

Life-Long Learning

As part of Nikon's "Life-Long Learning" commitment to ongoing product support and education, continually-updated information is available on-line at the following sites:

- **For users in the U.S.A.:** <http://www.nikonusa.com/>
- **For users in Europe and Africa:** <http://www.europe-nikon.com/support>
- **For users in Asia, Oceania, and the Middle East:** <http://www.nikon-asia.com/>

Visit these sites to keep up-to-date with the latest product information, tips, answers to frequently-asked questions (FAQs), and general advice on digital imaging and photography. Additional information may be available from the Nikon representative in your area. See the following URL for contact information: <http://imaging.nikon.com/>



Introduction



This chapter covers information you will need to know before using the camera, including the names of camera parts, how to use the camera menus, and how to ready the camera for use.

Overview	2
Getting to Know the Camera.....	3
The Camera Body	3
The Mode Dial	6
The Control Panel.....	7
The Viewfinder	9
The Shooting Information Display.....	10
The Command Dials.....	13
Attaching the AN-DC1 Camera Strap	17
The BM-10 Monitor Cover	17
The DK-21 Viewfinder Eyepiece Cup.....	17
Camera Menus	18
Using Camera Menus.....	19
Help.....	21
First Steps.....	22
Charge the Battery	22
Insert the Battery	23
Attach a Lens	25
Basic Setup	27
Inserting Memory Cards.....	29
Adjust Viewfinder Focus.....	32

Overview

Thank you for your purchase of a Nikon single-lens reflex (SLR) digital camera. To get the most from your camera, please be sure to read all instructions thoroughly and keep them where they will be read by all who use the product.



✔ Use Only Nikon Brand Accessories

Only Nikon brand accessories certified by Nikon specifically for use with your Nikon digital camera are engineered and proven to operate within its operational and safety requirements. THE USE OF NON-NIKON ACCESSORIES COULD DAMAGE YOUR CAMERA AND MAY VOID YOUR NIKON WARRANTY.

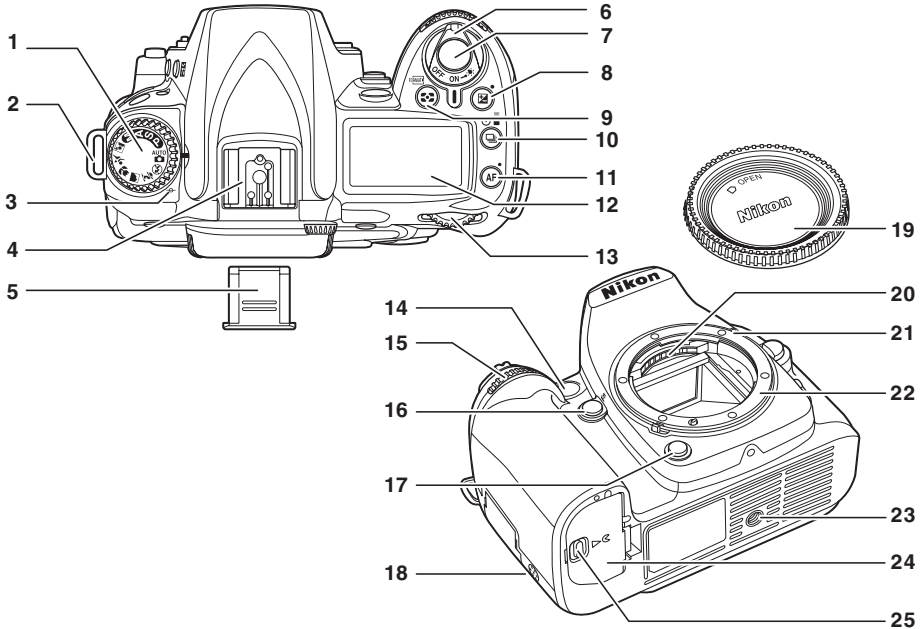
✔ Servicing the Camera and Accessories

The camera is a precision device and requires regular servicing. Nikon recommends that the camera be inspected by the original retailer or a Nikon-authorized service representative once every one to two years, and that it be serviced once every three to five years (note that fees apply to these services). Frequent inspection and servicing are particularly recommended if the camera is used professionally. Any accessories regularly used with the camera, such as lenses or optional flash units, should be included when the camera is inspected or serviced.

Getting to Know the Camera

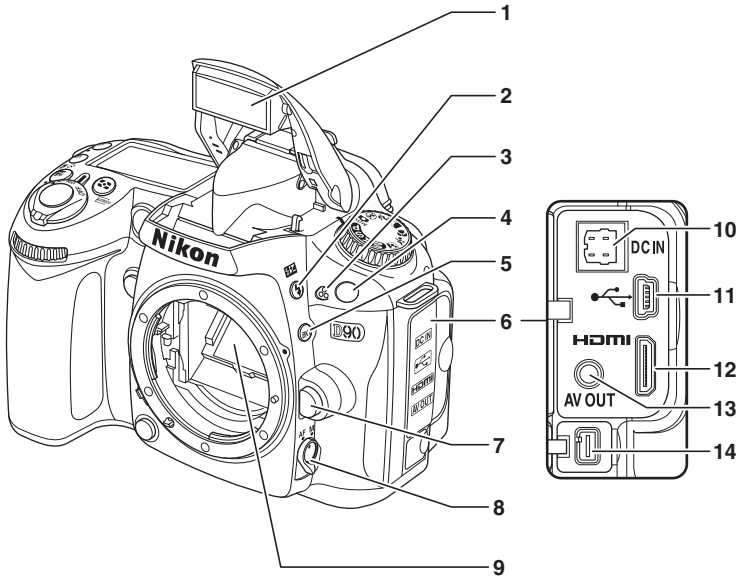
Take a few moments to familiarize yourself with camera controls and displays. You may find it helpful to bookmark this section and refer to it as you read through the rest of the manual.

The Camera Body

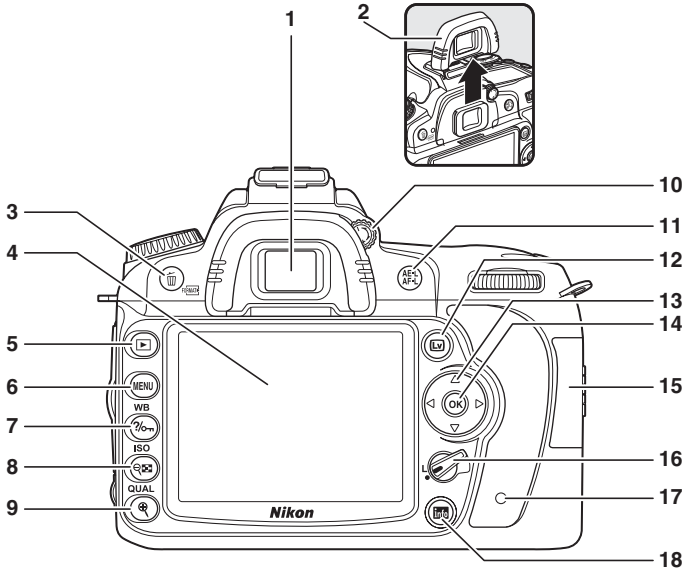


1 Mode dial.....	6	13 Main command dial.....	13
2 Eyelet for camera strap	17	14 AF-assist illuminator	174
3 Focal plane mark (☉)	60	Self-timer lamp.....	67
4 Accessory shoe (for optional flash unit).....	233	Red-eye reduction lamp	71
5 Accessory shoe cover	233	15 Sub-command dial	13
6 Power switch	34	16 Fn button.....	197, 198
7 Shutter-release button.....	38	17 Depth-of-field preview button	82
8 (exposure compensation) button.....	90	18 Speaker	
Two-button reset button	75	19 Body cap	240
9 (metering) button.....	87	20 CPU contacts	
(format) button	30	21 Mounting index.....	25
10 (release mode) button	64	22 Lens mount.....	60
11 AF (autofocus mode) button	54	23 Tripod socket	
Two-button reset button	75	24 Battery-chamber cover.....	23
12 Control panel.....	7	25 Battery-chamber cover latch.....	23





1 Built-in flash.....	70	9 Mirror	43, 246
2 (flash mode) button.....	70	10 DC-IN connector for optional EH-5a or	
 (flash compensation) button.....	91	EH-5 AC adapter	239
3 Microphone	50, 170	11 USB connector	
4 Infrared receiver	69	Connecting to a computer	149
5 BKT (bracketing) button	92	Connecting to a printer.....	151
6 Connector cover	146, 147, 149, 151	12 HDMI mini-pin connector	147
7 Lens release button	26	13 Video connector	146
8 Focus-mode selector	54, 59	14 Accessory terminal	241



1	Viewfinder eyepiece	32	9	⏪ (playback zoom in) button.....	138
2	DK-21 viewfinder eyepiece cup.....	17		QUAL (image quality/size) button	
3	⏻ (delete) button			Image quality	62
	Deleting pictures	49		Image size.....	63
	Deleting pictures during playback.....	140	10	Diopter adjustment control.....	32
	FORMAT (format) button.....	30	11	AE-L/AF-L button	
4	Monitor			Focus lock.....	57
	Live view	43		Choosing role.....	200
	Viewing pictures	50	12	LV (live view) button	
	Full-frame playback.....	128		Taking photographs	43
5	▶ (playback) button	50, 128		Shooting movies.....	50
6	MENU (menu) button.....	19, 159	13	Multi selector	19
7	?/⏻ (help/protect) button.....	21, 139	14	OK (OK) button.....	19
	WB (white balance) button		15	Memory card slot cover.....	29
	White balance	95	16	Focus selector lock.....	56
	Fine tuning white balance.....	97	17	Memory card access lamp	29, 39
	Color temperature	99	18	INFO (information display/quick settings	
8	⏪ (thumbnail/playback zoom out)			display) button	10, 12
	button.....	135			
	ISO (ISO sensitivity) button.....	74			



The Mode Dial

The camera offers a choice of the following eleven shooting modes:

■ ■ P, S, A, and M Modes

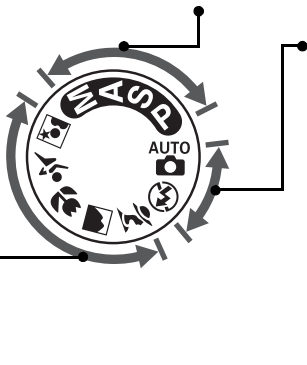
Select these modes for full control over camera settings.

P—Programmed auto (pg. 80): Camera chooses shutter speed and aperture, user controls other settings.

S—Shutter-priority auto (pg. 81): Choose fast shutter speeds to freeze action, slow shutter speeds to suggest motion by blurring moving objects.

A—Aperture-priority auto (pg. 82): Adjust aperture to soften background details or increase depth-of-field to bring both main subject and background into focus.

M—Manual (pg. 83): Match shutter speed and aperture to your creative intent.



■ ■ Auto Modes

Select these modes for simple, point-and-shoot photography.

AUTO Auto (pg. 34): Camera adjusts settings automatically to produce optimal results with “point-and-shoot” simplicity. Recommended for first-time users of digital cameras.

Auto (flash off) (pg. 34): As above, except that the flash will not fire even when lighting is poor.

■ ■ Scene Modes

Selecting a scene mode automatically optimizes settings to suit the selected scene, making creative photography as simple as rotating the mode dial.

Portrait (pg. 41): Shoot portraits with background in soft focus.

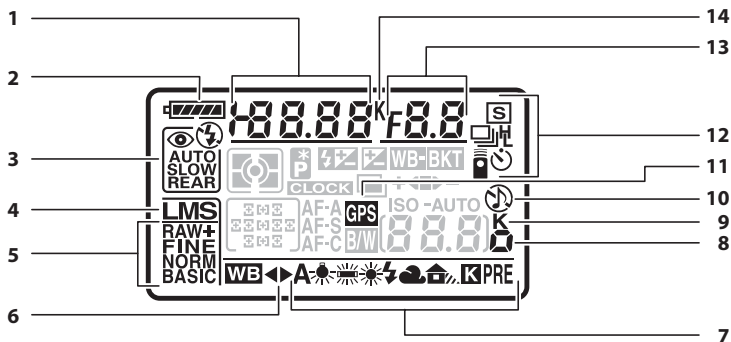
Landscape (pg. 41): Preserve details in landscape shots.

Close up (pg. 42): Take vivid close-ups of flowers, insects, and other small objects.

Sports (pg. 42): Freeze motion for dynamic sports shots.

Night portrait (pg. 42): Shoot portraits against a dimly-lit backdrop.

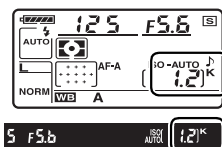
The Control Panel

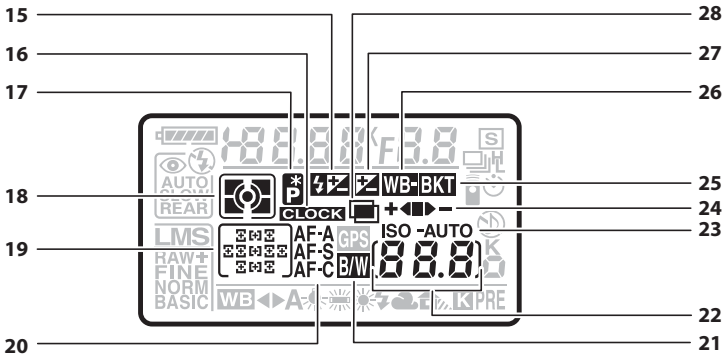


<p>1 Shutter speed</p> <ul style="list-style-type: none"> Shutter-priority auto.....81 Manual exposure mode83 <p>Exposure compensation value.....90</p> <p>Flash compensation value.....91</p> <p>White balance fine-tuning.....97</p> <p>White balance color temperature99</p> <p>White balance preset number..... 100</p> <p>Number of shots in bracketing sequence.....92</p> <p>2 Battery indicator.....34</p> <p>3 Flash mode.....71</p> <p>4 Image size.....63</p> <p>5 Image quality62</p> <p>6 White balance fine-tuning indicator.....97</p> <p>7 White balance95</p>	<p>8 ISO sensitivity compensation indicator</p> <ul style="list-style-type: none"> ISO sensitivity.....74 ISO display and adjustment..... 181 <p>9 "K" (appears when memory remains for over 1000 exposures)35</p> <p>10 "Beep" indicator 180</p> <p>11 GPS connection indicator 124</p> <p>12 Release mode.....64</p> <p>13 Aperture (f-number)</p> <ul style="list-style-type: none"> Aperture-priority auto82 Manual exposure mode83 <p>Bracketing increment</p> <ul style="list-style-type: none"> AE/flash bracketing.....92 White balance bracketing 191 Bracketing programs..... 264 <p>14 Color temperature.....99</p>
---	--

Large-Capacity Memory Cards



When enough memory remains on the memory card to record a thousand or more pictures at current settings, the number of exposures remaining will be shown in thousands, rounded down to the nearest hundred (e.g., if there is room for 1,260 exposures, the exposure count display will show 1.2 K).



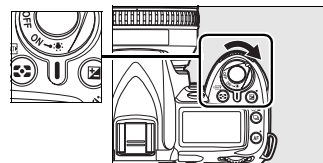


<p>15 Flash compensation indicator 91</p> <p>16 "Clock not set" indicator Clock battery 27 Warnings 255</p> <p>17 Flexible program indicator 80</p> <p>18 Metering 87</p> <p>19 Focus points 56 AF-area mode 173</p> <p>20 Autofocus mode 54</p> <p>21 Black-and-white indicator 181</p> <p>22 Number of exposures remaining 35 Number of shots remaining before memory buffer fills 65 Preset white balance recording indicator 101 Capture mode indicator 148 ISO sensitivity ISO sensitivity 74 ISO display and adjustment 181</p>	<p>23 ISO sensitivity indicator 74 Auto ISO sensitivity indicator 166</p> <p>24 Bracketing progress indicator AE/flash bracketing 92 White balance bracketing 191 ADL bracketing 193</p> <p>25 Bracketing indicator 92</p> <p>26 White balance bracketing indicator 191</p> <p>27 Exposure compensation indicator 90</p> <p>28 Multiple exposure indicator 121</p>
--	--

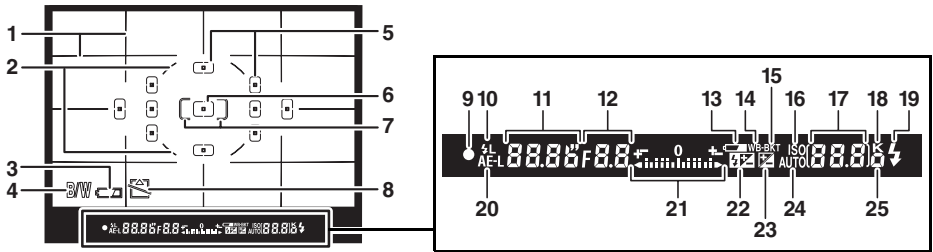
The LCD Illuminator

Holding the power switch in the  position activates the exposure meters and the control panel backlight (LCD illuminator), allowing the display to be read in the dark. After the power switch is released, the illuminator will remain lit while the camera exposure meters are active (six seconds at default settings) or until the shutter is released or the power switch is rotated to  again.

Power switch



The Viewfinder



- 1 Framing grid (displayed when **On** is selected for Custom Setting d2)..... 181
- 2 Reference circle for center-weighted metering 87
- 3 Battery indicator * 34
- 4 Black-and-white indicator * 181
- 5 Focus points..... 54, 173, 174
- 6 Center focus point (normal frame)..... 174
- 7 Center focus point (wide frame)..... 174
- 8 “No memory card” warning * 181
- 9 Focus indicator 38, 60
- 10 Flash value (FV) lock indicator 198
- 11 Shutter speed 81, 83
- 12 Aperture (f-number) 82, 83
- 13 Battery indicator 34
- 14 White balance bracketing indicator..... 191
- 15 Bracketing indicator 92
- 16 ISO sensitivity indicator 74
- 17 Number of exposures remaining 35
Number of shots remaining before memory buffer fills..... 65
- White balance recording indicator 101
- Exposure compensation value 90
- Flash compensation value 91
- Capture mode indicator..... 148
- ISO sensitivity..... 74, 181
- 18 “K” (appears when memory remains for over 1000 exposures) 35
- 19 Flash-ready indicator..... 42
- 20 Autoexposure (AE) lock indicator 88
- 21 Electronic analog exposure display 84
Exposure compensation 90
- 22 Flash compensation indicator 91
- 23 Exposure compensation indicator 90
- 24 Auto ISO sensitivity indicator 166
- 25 ISO sensitivity compensation indicator.. 74

* Can be hidden with Custom Setting d4 (pg. 181).

✓ The Viewfinder Display

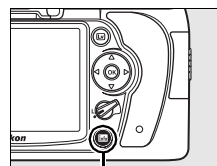
Owing to the characteristics of this type of viewfinder display, you may notice fine lines radiating outward from the selected focus point. This is normal and does not indicate a malfunction. If the battery is totally exhausted or not inserted, the display in the viewfinder will dim. The viewfinder display will return to normal when a fully-charged battery is inserted.

✓ The Control Panel and Viewfinder

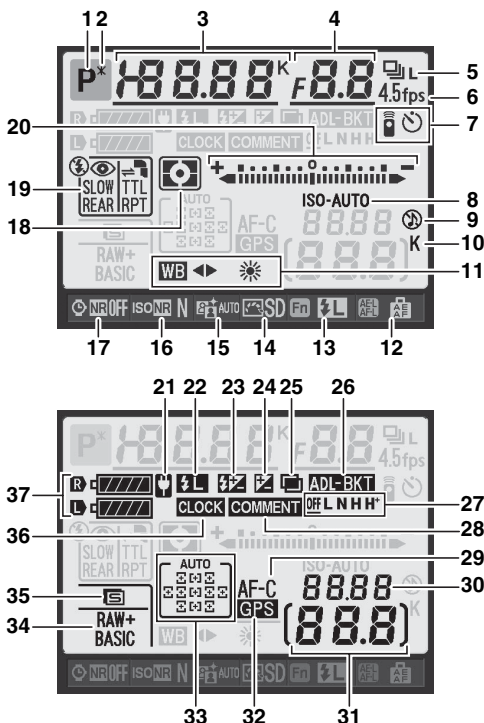
The response times and brightness of the control panel and viewfinder may vary with temperature.

The Shooting Information Display

Shooting information, including shutter speed, aperture, the number of exposures remaining, and AF-area mode, is displayed in the monitor when the **Info** button is pressed. Press the **Info** button again to change selected settings (pg. 12). To clear shooting information from the monitor, press the **Info** button a third time or press the shutter-release button halfway. At default settings, the monitor will turn off automatically if no operations are performed for about 10 seconds.





Info button



See Also

For information on choosing how long the monitor stays on, see Custom Setting c4 (**Monitor off delay**, pg. 180). For information on changing the color of the lettering in the shooting information display, see Custom Setting d8 (**Shooting info display**, pg. 183).

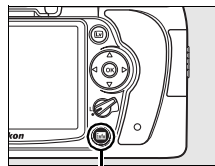
The Shooting Information Display (Continued)

1 Shooting mode	18 Metering	87
 auto/  auto (flash off)	19 Flash mode.....	71
Scene modes	Flash control mode for	
P, S, A, and M modes.....	optional flash units	233
2 Flexible program indicator	20 Electronic analog exposure display	84
3 Shutter speed	Exposure compensation	90
Shutter-priority auto.....	Bracketing progress indicator	
Manual exposure mode	AE/flash bracketing.....	92
Exposure compensation value.....	White balance bracketing	191
Flash compensation value.....	ADL bracketing.....	193
Color temperature	21 AC adapter indicator	34
Number of shots in bracketing	22 Flash value (FV) lock indicator	198
sequence.....	23 Flash compensation indicator.....	91
	24 Exposure compensation indicator	90
	25 Multiple exposure indicator	121
	26 Bracketing indicator	
4 Aperture (f-number)	AE/flash bracketing.....	92
Aperture priority auto.....	White balance bracketing	191
Manual exposure mode	ADL bracketing.....	193
Bracketing increment	27 Active D-Lighting bracketing amount ...	193
AE/flash bracketing.....	28 Image comment indicator.....	205
White balance bracketing.....	29 Autofocus mode	54
Bracketing programs	30 ISO sensitivity.....	74, 181
5 Release mode.....	31 Number of exposures remaining	35
6 Continuous shooting speed	32 GPS connection indicator.....	124
7 Remote control mode indicator	33 Auto-area AF indicator.....	173
Self-timer mode indicator.....	3D-tracking indicator	173
8 ISO sensitivity indicator	Focus point	54
Auto ISO sensitivity indicator	AF-area mode indicator.....	173
9 “Beep” indicator.....	34 Image size.....	63
10 “K” (appears when memory remains for	35 Image quality	62
over 1000 exposures)	36 “Clock not set” indicator	27, 255
11 White balance	37 Camera battery indicator.....	34
White balance fine-tuning indicator.....	MB-D80 battery type display.....	184
12 AE-L/AF-L button assignment.....	MB-D80 battery indicator	184
13 Fn button assignment.....		
14 Picture Control indicator		
15 Active D-Lighting indicator		
16 High ISO noise reduction indicator		
17 Long exposure noise reduction		
indicator		

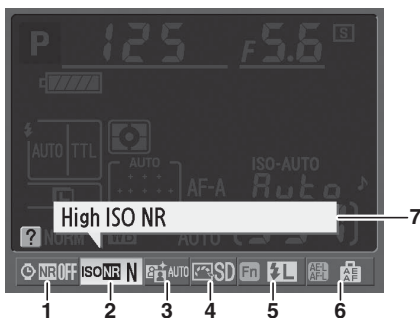


■ Changing Settings in the Shooting Information Display (Quick Settings Display)

To change settings for the items listed below, press the **Info** button in the shooting information display. Highlight items using the multi selector and press **OK** to jump to the menu for the highlighted item.



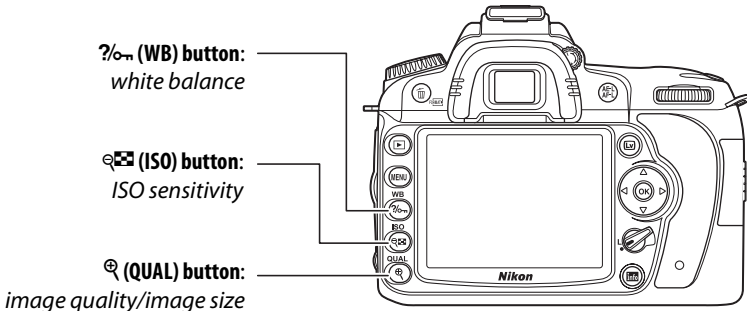
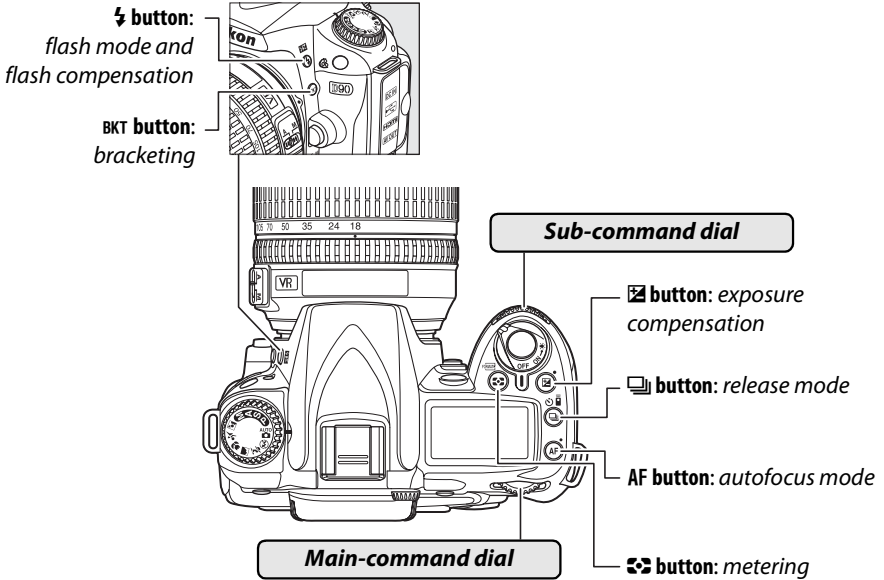
Info button



1	Long exposure noise reduction	167	5	Fn button assignment	197
2	High ISO noise reduction.....	168	6	AE-L/AF-L button assignment	200
3	Active D-Lighting	119	7	Tip display	182
4	Picture Control.....	108			

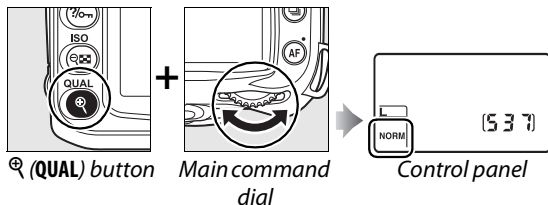
The Command Dials

The main- and sub-command dials are used alone or in combination with other controls to adjust a variety of settings.

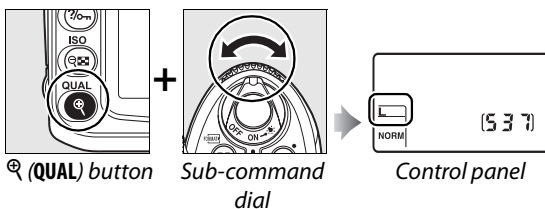


■ Image Quality and Size

Set image quality (pg. 62).

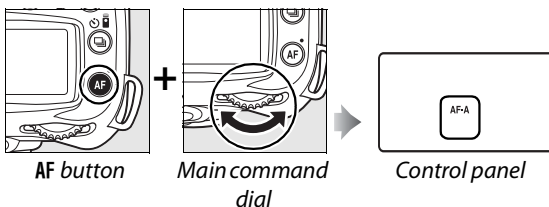


Choose an image size (pg. 63).



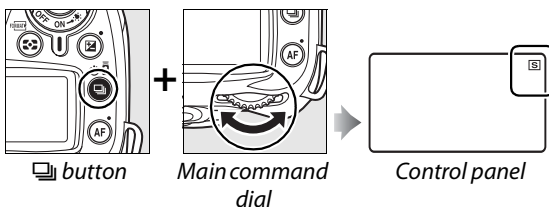
Autofocus Mode

Choose an autofocus mode (pg. 54).



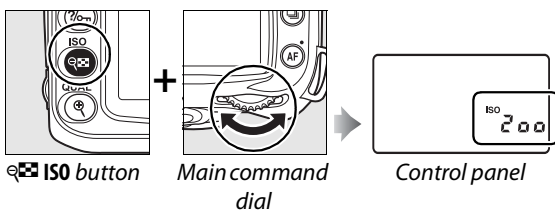
Release Mode

Choose a release mode (pg. 64).



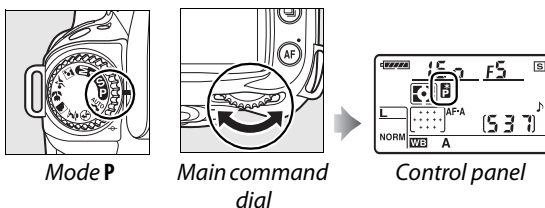
ISO Sensitivity

Set ISO sensitivity (pg. 74).

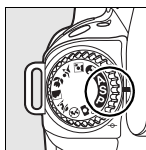


Exposure

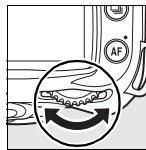
Choose a combination of aperture and shutter speed (exposure mode P; pg. 80).



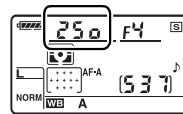
Choose a shutter speed
(exposure mode **S** or **M**; pp. 81,
83).



Mode S or M

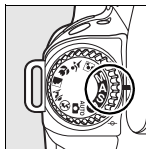


*Main command
dial*

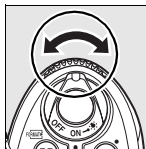


Control panel

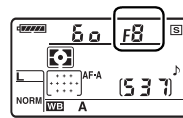
Choose an aperture
(exposure mode **A** or **M**;
pp. 82, 83).



Mode A or M

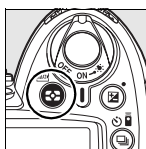


*Sub-command
dial*



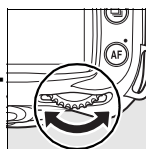
Control panel

Choose a metering method
(pg. 87).



button

+

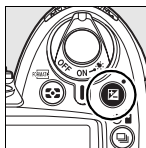


*Main command
dial*



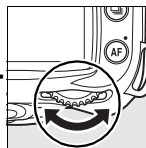
Control panel

Set exposure compensation
(pg. 90).

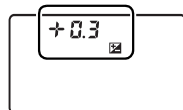


button

+

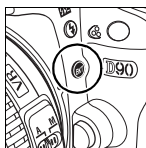


*Main command
dial*



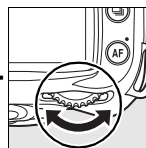
Control panel

Activate or cancel bracketing/
select number of shots in
bracketing sequence (pp. 92,
191). Not displayed in ADL
bracketing (pg. 193).

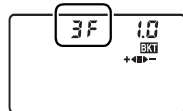


BKT button

+

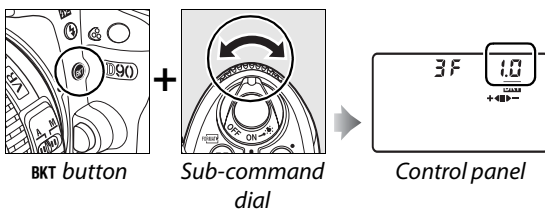


*Main command
dial*



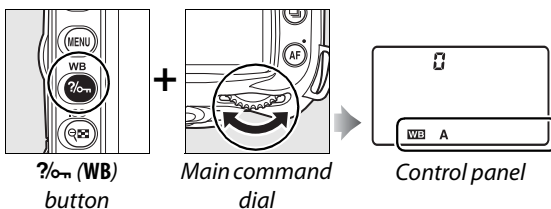
Control panel

Select bracketing exposure increment (pg. 92, 192).

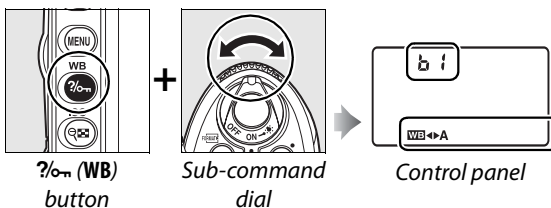


White Balance

Choose a white balance setting (pg. 95).

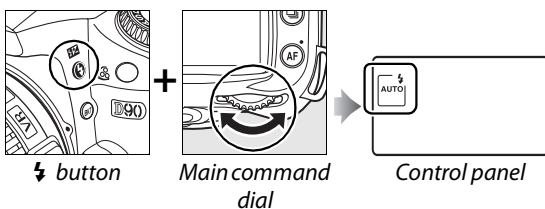


Fine-tune white balance (pg. 97), set color temperature (pg. 99), or choose a white balance preset (pg. 106).

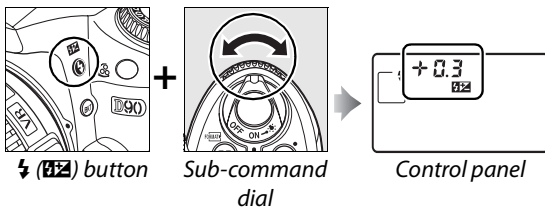


Flash Settings

Choose flash mode (pg. 71).

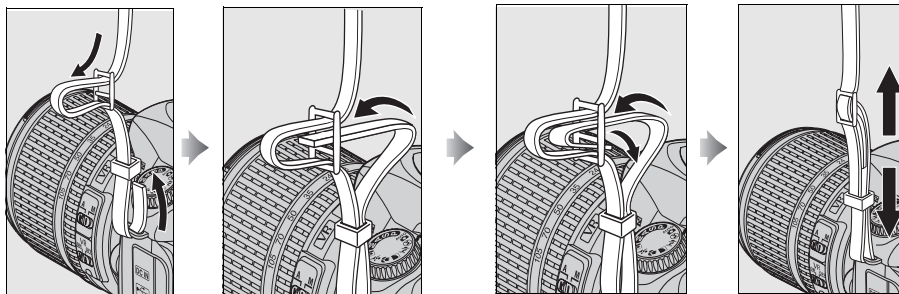


Adjust flash compensation (pg. 91).



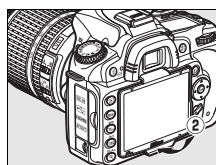
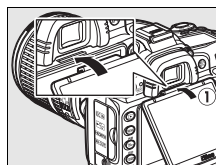
Attaching the AN-DC1 Camera Strap

Attach the strap as shown below.

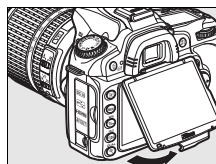


The BM-10 Monitor Cover

A clear plastic cover is provided with the camera to keep the monitor clean and protect it when the camera is not in use. To attach the cover, insert the projection on the top of the cover into the matching indentation above the camera monitor (1) and press the bottom of the cover until it clicks into place (2).

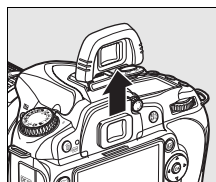


To remove the cover, hold the camera firmly and pull the bottom of the cover gently outwards as shown at right.



The DK-21 Viewfinder Eyepiece Cup

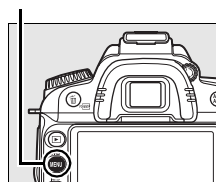
Before attaching the DK-5 viewfinder eyepiece cap and other viewfinder accessories (pg. 239), remove the viewfinder eyepiece cup by placing your fingers underneath the flanges at either side and sliding it off as shown at right.



Camera Menus

Most shooting, playback, and setup options can be accessed from the camera menus. To view the menus, press the **MENU** button.

MENU button



Tabs

Choose from playback, shooting, Custom Settings, setup, retouch, and recent settings menus (see below).

?
If “?” is displayed, help for current item can be viewed by pressing **?/ⓘ** button (pg. 21).



Slider shows position in current menu.

Current settings are shown by icons.

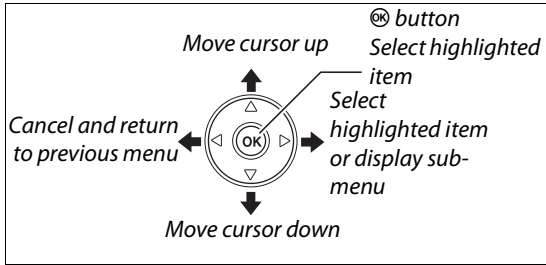
Menu options
Options in current menu.

The following menus are available:

Playback	(pg. 160)	Adjust playback settings and manage photos.
Shooting	(pg. 165)	Adjust shooting settings.
Custom Settings	(pg. 171)	Personalize camera settings.
Setup	(pg. 202)	Format memory cards and perform basic camera setup.
Retouch	(pg. 209)	Create retouched copies of existing photographs.
Recent settings	(pg. 224)	Select from the twenty most recently used menu items. If desired, a custom menu (“My Menu”) can be displayed in place of Recent settings (pg. 224).

Using Camera Menus

The multi selector and **OK** button are used to navigate the camera menus.

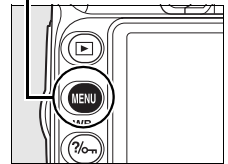


Follow the steps below to navigate the menus.

1 Display the menus.

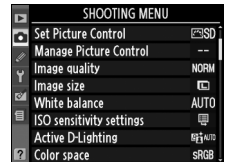
Press the **MENU** button to display the menus.

MENU button



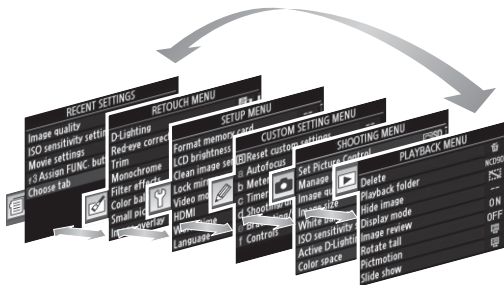
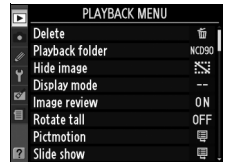
2 Highlight the icon for the current menu.

Press **◀** to highlight the icon for the current menu.



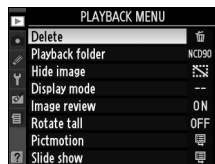
3 Select a menu.

Press **▲** or **▼** to position the cursor in the selected menu.



4 Position the cursor in the selected menu.

Press ► to position the cursor in the selected menu.



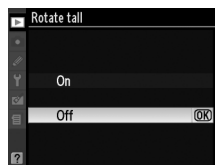
5 Highlight a menu item.

Press ▲ or ▼ to highlight a menu item.



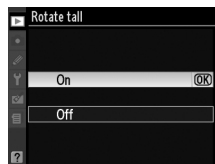
6 Display options.

Press ► to display options for the selected menu item.



7 Highlight an option.

Press ▲ or ▼ to highlight an option.



8 Select the highlighted item.

Press **OK** to select the highlighted item. To exit without making a selection, press the **MENU** button.



Note the following:

- Menu items that are displayed in gray are not currently available.
- While pressing ► or the center of the multi selector generally has the same effect as pressing **OK**, there are some cases in which selection can only be made by pressing **OK**.
- To exit the menus and return to shooting mode, press the shutter-release button halfway (pg. 35).

Using the Command Dials

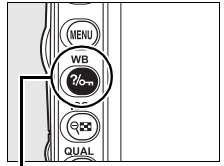
The main command dial can be used to move the cursor up and down, the sub-command dial to move the cursor left and right. The sub-command dial can not be used to make a selection.

Help

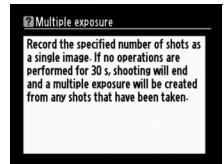
If a ? icon is displayed at the bottom left corner of the monitor, help can be displayed by pressing the ?/Fn button. A description of the currently selected option or menu will be displayed while the button is pressed. Press ▲ or ▼ to scroll through the display.



? icon



?/Fn button



First Steps

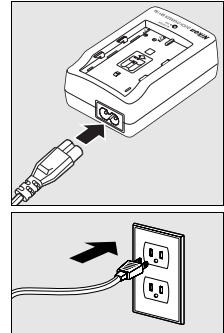
Charge the Battery

The camera is powered by an EN-EL3e rechargeable Li-ion battery (supplied).

The EN-EL3e is not fully charged at shipment. To maximize shooting time, charge the battery in the supplied MH-18a quick charger before use. About two and a quarter hours are required to fully recharge the battery when no charge remains.

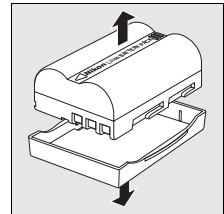
1 Plug the charger in.

Insert the AC adapter plug into the battery charger and plug the power cable into an electrical outlet.



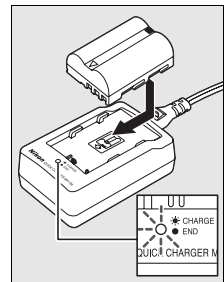
2 Remove the terminal cover.

Remove the terminal cover from the battery.



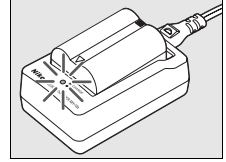
3 Insert the battery.

Insert the battery into the charger. The **CHARGE** lamp will blink while the battery charges.



4 Remove the battery when charging is complete.

Charging is complete when the **CHARGE** lamp stops blinking. Remove the battery and unplug the charger.

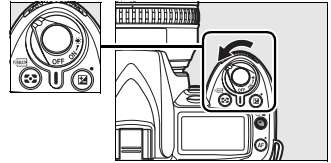


Insert the Battery

1 Turn the camera off.

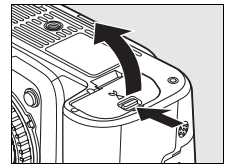
Always turn the camera off before inserting or removing batteries.

Power switch



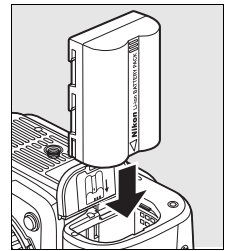
2 Open the battery-chamber cover.

Open the battery-chamber cover on the bottom of the camera.

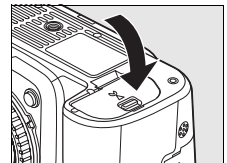


3 Insert the battery.

Insert the battery as shown at right.



4 Close the battery-chamber cover.



■ ■ Removing the Battery

Before removing the battery, turn the camera off. To prevent short-circuits, replace the terminal cover when the battery is not in use.

✔ **The Battery and Charger**

Read and follow the warnings and cautions on pages xiv–xv and 248–249 of this manual. Do not use the battery at ambient temperatures below 0°C (32°F) or above 40°C (104°F). Charge the battery indoors at ambient temperatures between 5–35°C (41–95°F); for best results, charge the battery at temperatures above 20°C (68°F). Battery capacity may temporarily drop if the battery is charged at low temperatures or used at a temperature below the temperature at which it was charged. If the battery is charged at a temperature below 5°C (41°F), the battery life indicator in the **Battery info** (pg. 208) display may show a temporary decrease.

The battery may be hot immediately after use. Wait for the battery to cool before recharging.

Use the charger with compatible batteries only. Unplug when not in use.

✔ **Incompatible Batteries**

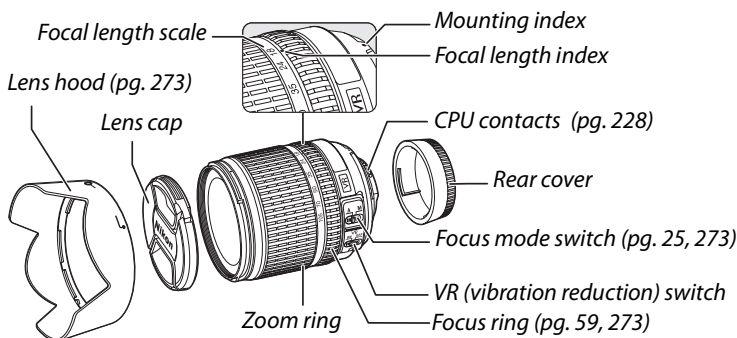
This camera can not be used with EN-EL3 or EN-EL3a rechargeable Li-ion batteries for the D100, D70 series, or D50 or with the MS-D70 CR2 battery holder.

✔ **EN-EL3e Rechargeable Li-ion Batteries**

The supplied EN-EL3e shares information with compatible devices, enabling the camera to show battery charge state in six levels (pg. 34). The **Battery info** option in the setup menu details battery charge, battery life, and the number of pictures taken since the battery was last charged (pg. 208).

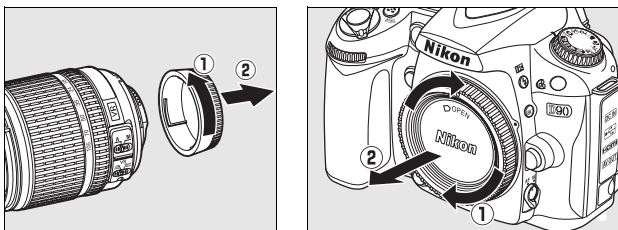
Attach a Lens

Care should be taken to prevent dust from entering the camera when the lens is removed. An AF-S DX NIKKOR 18-105mm f/3.5-5.6G ED VR lens is used in this manual for illustrative purposes.



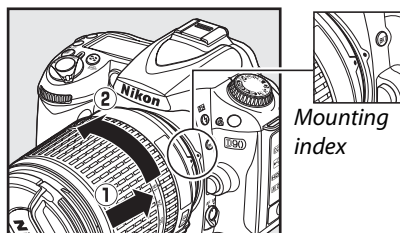
1 Remove the rear lens cap and the camera body cap.

After confirming that the camera is off, remove the rear lens cap from the lens and remove the camera body cap.



2 Attach the lens.

Keeping the mounting mark on the lens aligned with the mounting mark on the camera body, position the lens in the camera's bayonet mount. Being careful not to press the lens-release button, rotate the lens counter-clockwise until it clicks into place.

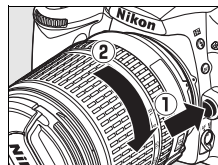


If the lens is equipped with an **A-M** or **M/A-M** switch, select **A** (autofocus) or **M/A** (autofocus with manual priority).



■ Detaching the Lens

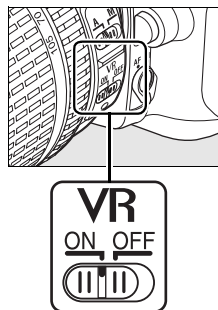
Be sure the camera is off when removing or exchanging lenses. To remove the lens, press and hold the lens release button while turning the lens clockwise. After removing the lens, replace the lens cap, rear cover, and camera body cap.



■ Vibration Reduction (VR)

AF-S DX Zoom-Nikkor 18–105 mm f/3.5–5.6G VR lenses support vibration reduction (VR), which reduces blur caused by camera shake even when the camera is panned, allowing shutter speeds to be slowed by approximately 3 EV at a focal length of 105 mm (Nikon measurements; effects vary with the user and shooting conditions).

To use vibration reduction, slide the VR switch to **ON**. Vibration reduction is activated when the shutter-release button is pressed halfway, reducing the effects of camera shake on the image in the viewfinder and simplifying the process of framing the subject and focusing in both autofocus and manual modes. When the camera is panned, vibration reduction applies only to motion that is not part of the pan (if the camera is panned horizontally, for example, vibration reduction will be applied only to vertical shake), making it much easier to pan the camera smoothly in a wide arc.



Vibration reduction can be turned off by sliding the VR switch to **OFF**. Turn vibration reduction off when the camera is securely mounted on a tripod, but leave it on if the tripod head is not secured or when using a monopod.

✓ CPU Lenses with Aperture Rings

In the case of CPU lenses equipped with an aperture ring (pg. 228), lock aperture at the minimum setting (highest f-number). See the lens manual for details.

✓ Vibration Reduction

Do not turn the camera off or remove the lens while vibration reduction is in effect. If power to the lens is cut while vibration reduction is on, the lens may rattle when shaken. This is not a malfunction, and can be corrected by reattaching the lens and turning the camera on.

Vibration reduction is disabled while the built-in flash is charging. When vibration reduction is active, the image in the viewfinder may be blurred after the shutter is released. This does not indicate a malfunction.

Basic Setup

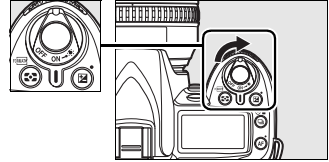
A language-selection dialog will be displayed the first time the camera is turned on. Choose a language and set the time and date. Note that if the time and date are not set, **LOCK** will blink in the monitor and the time and date recorded with photographs will be incorrect.



1 Turn the camera on.

A language-selection dialog will be displayed.

Power switch



2 Select a language.

Press ▲ or ▼ to highlight the desired language and press **OK**.



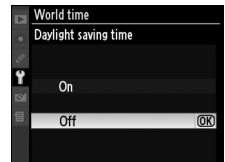
3 Choose a time zone.

A time-zone selection dialog will be displayed. Press ◀ or ▶ to highlight the local time zone (the **UTC** field shows the difference between the selected time zone and Coordinated Universal Time, or UTC, in hours) and press **OK**.



4 Turn daylight saving time on or off.

Daylight saving time options will be displayed. Daylight saving time is off by default; if daylight saving time is in effect in the local time zone, press ▲ to highlight **On** and press **OK**.



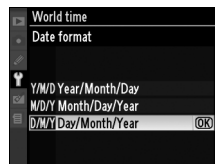
5 Set the date and time.

The dialog shown at right will be displayed. Press ◀ or ▶ to select an item, ▲ or ▼ to change. Press **OK** when the clock is set to the current date and time.



6 Choose a date format.

Press ▲ or ▼ to choose the order in which the year, month, and day will be displayed and press **OK**.



7 Exit to shooting mode.


Press the shutter-release button halfway to exit to shooting mode.



The Setup Menu

Language and date/time settings can be changed at any time using the **Language** (pg. 204) and **World time** (pg. 204) options in the setup menu.

The Clock Battery

The camera clock is powered by an independent, rechargeable power source, which is charged as necessary when the main battery is installed or the camera is powered by an optional EH-5a or EH-5 AC adapter (pg. 239). Two days of charging will power the clock for about three months. If the  icon flashes in the control panel, the clock battery is exhausted and the clock has been reset. Set the clock to the correct time and date.

The Camera Clock

The camera clock is less accurate than most watches and household clocks. Check the clock regularly against more accurate time pieces and reset as necessary.

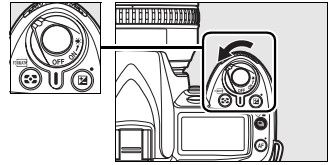
Inserting Memory Cards

The camera stores pictures on Secure Digital (SD) memory cards (available separately).

1 Turn the camera off.

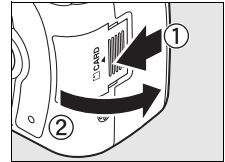
Always turn the camera off before inserting or removing memory cards.

Power switch



2 Open the card slot cover.

Slide the card slot cover out (1) and open the card slot (2).



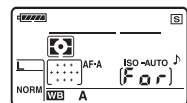
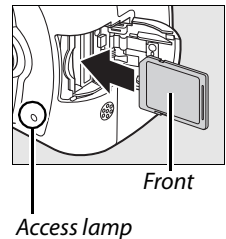
3 Insert the memory card.

Holding the memory card as shown at right, slide it in until it clicks into place. The memory card access lamp will light for a few seconds. Close the memory card slot cover.

✓ Inserting Memory Cards

Inserting memory cards upside down or backwards could damage the camera or the card. Check to be sure the card is in the correct orientation.

If **F o r** is displayed in the control panel as shown at right, format the card as described on the following page.



✓ The Access Lamp

Do not remove the battery or disconnect the power source while the memory card access lamp is lit. Failure to observe this precaution could result in damage to the card.



■ ■ Formatting Memory Cards

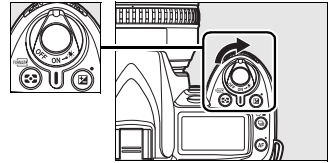
Memory cards must be formatted after being used in other devices. Format the card as described below.

✓ Formatting Memory Cards




Formatting memory cards permanently deletes any data they may contain. Be sure to copy any photographs and other data you wish to keep to a computer before proceeding (pg. 148).

1 Turn the camera on.


Power switch

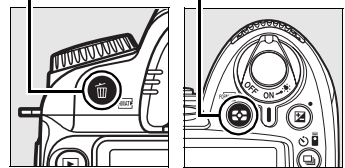





2 Press the buttons.

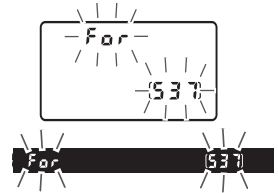
Hold the  ( and ) buttons down simultaneously for approximately two seconds.

 button




 button



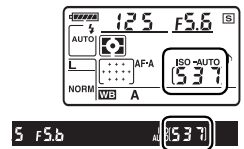
A blinking **F a r** will appear in the shutter-speed displays in the control panel and viewfinder. To exit without formatting the memory card, wait six seconds (the default setting) until **F a r** stops blinking or press any button other than the  ( and ) buttons.



3 Press the buttons again.

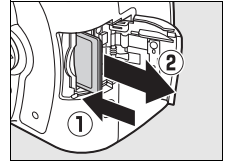
Press the  ( and ) buttons together a second time while **F a r** is blinking to format the memory card. *Do not remove the memory card or remove or disconnect the power source during formatting.*

When formatting is complete, the control panel and viewfinder will show the number of photographs that can be recorded at current settings.



■ Removing Memory Cards

After confirming that the access lamp is off, turn the camera off, open the memory card slot cover, and press the card in to eject it (1). The card can then be removed by hand (2).

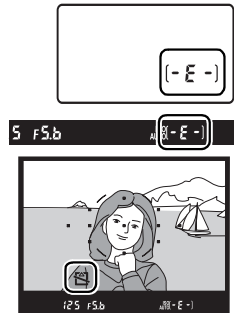


✓ Memory Cards

- Memory cards may be hot after use. Observe due caution when removing memory cards from the camera.
- Memory cards that have been formatted in a computer or other device must be reformatted in the camera before they can be used for recording or playback.
- Turn the power off before inserting or removing memory cards. Do not remove memory cards from the camera, turn the camera off, or remove or disconnect the power source during formatting or while data are being recorded, deleted, or copied to a computer. Failure to observe these precautions could result in loss of data or in damage to the camera or card.
- Do not touch the card terminals with your fingers or metal objects.
- Do not bend, drop, or subject to strong physical shocks.
- Do not apply force to the card casing. Failure to observe this precaution could damage the card.
- Do not expose to water, heat, high levels of humidity, or direct sunlight.

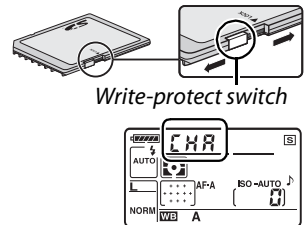
✎ No Memory Card

If no memory card is inserted, the control panel and viewfinder will show (- E -) and an icon will appear in the viewfinder as shown at right. If the camera is turned off with a charged EN-EL3e battery and no memory card inserted, (- E -) will be displayed in the control panel and an icon will be displayed in the viewfinder.



✎ The Write Protect Switch

Memory cards are equipped with a write protect switch to prevent accidental loss of data. When this switch is in the "lock" position, photos can not be recorded or deleted and the memory card can not be formatted. To unlock the memory card, slide the switch to the "write" position.



✎ See Also

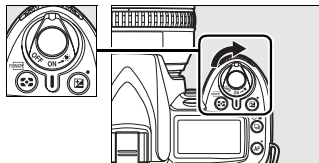
See page 202 for information on formatting memory cards using the **Format memory card** option in the setup menu.

Adjust Viewfinder Focus

The camera is equipped with diopter adjustment to accommodate individual differences in vision. Check that the display in the viewfinder is in focus before framing pictures in the viewfinder.

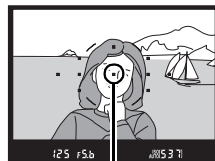
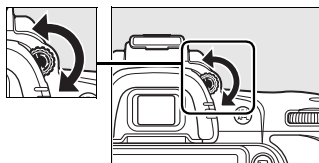
1 Remove the lens cap and turn the camera on.

Power switch



2 Focus the viewfinder.

Rotate the diopter control until the viewfinder display and focus point are in sharp focus. When operating the diopter control with your eye to the viewfinder, be careful not to put your fingers or fingernails in your eye.



Focus point

Eyepiece Correction Lenses

Corrective lenses (available separately; pg. 239) can be used to further adjust viewfinder diopter.



Basic Photography and Playback



This chapter outlines the basics of taking and viewing photographs in auto and scene modes. It assumes that default camera settings are used; for information on restoring default settings, see page 258.



- “Point-and-Shoot” Photography (Auto and Scene Modes)..... 34**
 - Step 1: Turn the Camera On 34
 - Step 2: Choose Shooting and Focus Modes..... 36
 - Step 3: Check Camera Settings 36
 - Step 4: Frame the Photograph 37
 - Step 5: Focus 38
 - Step 6: Shoot..... 39
- Creative Photography (Scene Modes) 41**
 - Portrait 41
 - Landscape..... 41
 - Close Up 42
 - Sports 42
 - Night Portrait..... 42
- Framing Pictures in the Monitor (Live View) 43**
- Basic Playback..... 48**
 - Deleting Unwanted Photographs 49
- Recording and Viewing Movies (Live View)..... 50**

Use a CPU Lens

Auto and scene modes are only available with CPU lenses. If these modes are selected when a non-CPU lens is attached, the shutter release will be disabled.

“Point-and-Shoot” Photography

(and Modes)

This section describes how to take photographs in  (auto) mode, an automatic “point-and-shoot” mode in which the majority of settings are controlled by the camera in response to shooting conditions, and in which the flash will fire automatically if the subject is poorly lit. To take photographs with the flash off while leaving the camera in control of other settings, rotate the mode dial to  to select auto (flash off) mode.

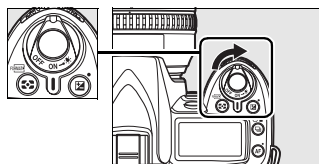


Step 1: Turn the Camera On

1 Turn the camera on.

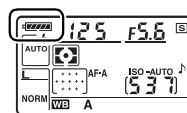
Remove the lens cap and turn the camera on. The control panel and viewfinder displays will light.









Power switch




2 Check the battery level.

Check the battery level in the viewfinder or control panel.



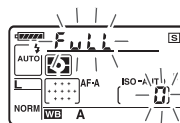
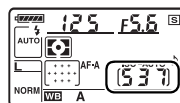
Control panel	Viewfinder	Description
	—	Battery fully charged.
	—	Battery partially discharged.
		
		
		Low battery. Ready fully-charged spare battery or prepare to charge battery.
 (blinks)	 (blinks)	Battery exhausted; shutter release disabled. Charge or exchange battery.

Note: When camera is powered by optional EH-5a or EH-5 AC adapter, battery level is not displayed; instead, a  icon appears in the shooting information display (pg. 10).

3 Check the number of exposures remaining.

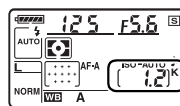
The exposure count displays in the control panel and viewfinder show the number of photographs that can be stored on the memory card. Check the number of exposures remaining.

If there is not enough memory to store additional photographs at current settings, the display will flash as shown at right. No further pictures can be taken until the memory card has been replaced (pg. 31) or photographs have been deleted (pp. 49, 162).



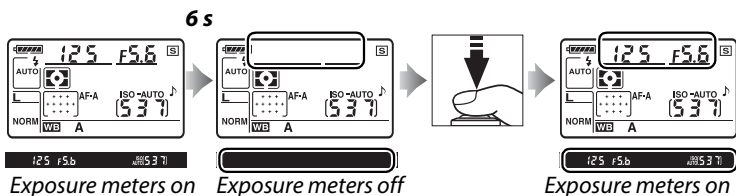
Large-Capacity Memory Cards

When enough memory remains on the memory card to record a thousand or more pictures at current settings, the number of exposures remaining will be shown in thousands, rounded down to the nearest hundred (e.g., if there is room for 1,260 exposures, the exposure count display will show 1.2 K).



Auto Meter Off

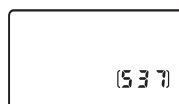
At default settings, the viewfinder and the shutter speed and aperture displays in the control panel will turn off if no operations are performed for about six seconds (auto meter off), reducing the drain on the battery. Press the shutter-release button halfway to reactivate the display in the viewfinder (pg. 38).



The length of time before the exposure meters turn off automatically can be adjusted using Custom Setting c2 (**Auto meter-off delay**, pg. 179).

Camera Off Display

If the camera is turned off with a battery and memory card inserted, the frame count and number of exposures remaining will be displayed (some memory cards may only display this information when the camera is on).

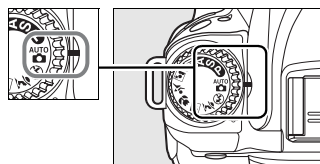


Step 2: Choose Shooting and Focus Modes

1 Select **AUTO** or **📷** mode.

To take photographs without the flash, rotate the mode dial to **📷**. Otherwise, rotate the mode dial to **AUTO**.

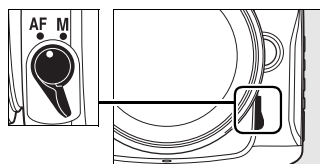
Mode dial



2 Select autofocus.

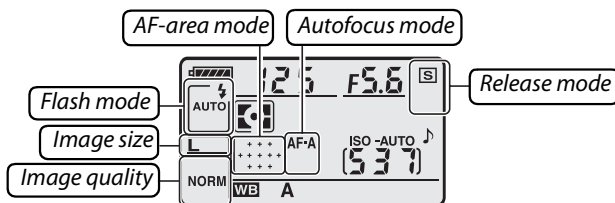
Rotate the focus-mode selector to **AF** (autofocus).

Focus-mode selector



Step 3: Check Camera Settings


Check settings in the control panel. The default settings for **AUTO** and **📷** mode are listed below.

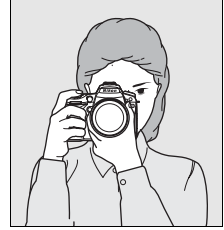


Option	Default	Description	Page
Flash mode (AUTO mode)	AUTO	If the subject is poorly lit, the flash will pop up automatically when the shutter-release button is pressed halfway and fire when the picture is taken.	70
Flash mode (📷 mode)	📷 (flash off)	Flash will not fire even when lighting is poor.	71
Image quality	NORM (JPEG Normal)	Record JPEG images at a compression ratio of roughly 1 : 8. Ideal for snapshots.	62
Image size	L (Large)	Images are 4,288 × 2,848 pixels in size.	63
Release mode	S (Single frame)	One picture is taken each time the shutter-release button is pressed.	64
Autofocus mode	AF-A (Auto select)	The camera automatically selects single-servo autofocus if the subject is stationary, continuous-servo autofocus if the subject is in motion. No picture will be taken if the camera is unable to focus.	54
AF-area mode	Auto-area	The camera automatically selects the focus point.	173

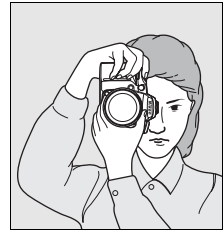
Step 4: Frame the Photograph

1 Ready the camera.

When framing photographs in the viewfinder, hold the handgrip in your right hand and cradle the camera body or lens with your left. Keep your elbows propped lightly against your torso for support and place one foot half a pace ahead of the other to keep your upper body stable. In  mode, shutter speeds slow when lighting is poor; use of a tripod is recommended.



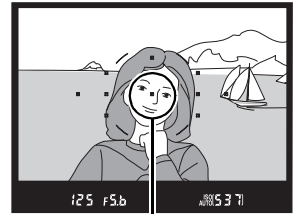
Hold the camera as shown at right when framing photographs in portrait (tall) orientation.



For information on framing photographs in the monitor in live view mode, see page 43.

2 Frame the photograph.

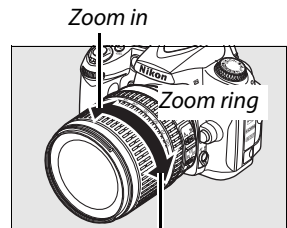
Frame a photograph in the viewfinder with the main subject in at least one of the eleven focus points.



Focus point

Using a Zoom Lens

Use the zoom ring to zoom in on the subject so that it fills a larger area of the frame, or zoom out to increase the area visible in the final photograph (select longer focal lengths on the lens focal length scale index to zoom in, shorter focal lengths to zoom out).



Zoom out

Step 5: Focus

1 Press the shutter-release button halfway.

Press the shutter-release button halfway to focus. The camera will select the focus points automatically. If the subject is poorly lit, the flash may pop up and the AF-assist illuminator may light.



2 Check the indicators in the viewfinder.

When the focus operation is complete, the selected focus points will be briefly highlighted, a beep will sound, and the in-focus indicator (●) will appear in the viewfinder. If the camera chooses single-servo autofocus (pg. 54), focus will lock while the shutter-release button is pressed halfway.

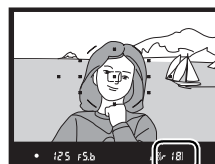


In-focus indicator

Buffer capacity

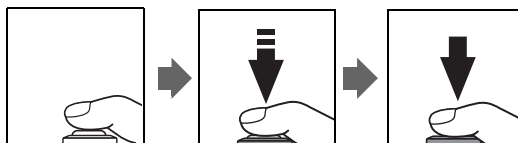
In-focus indicator	Description
●	Subject in focus.
● (blinks)	Camera unable to focus using autofocus. See page 55.

While the shutter-release button is pressed halfway, the number of exposures that can be stored in the memory buffer ("18"; pg. 65) will be displayed in the viewfinder.



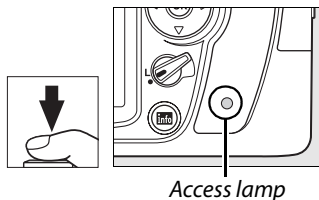
The Shutter-Release Button

The camera has a two-stage shutter-release button. The camera focuses when the shutter-release button is pressed halfway. To take the photograph, press the shutter-release button the rest of the way down.



Step 6: Shoot

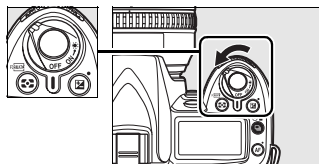
Smoothly press the shutter-release button the rest of the way down to release the shutter and record the photograph. The access lamp next to the memory card slot cover will light. *Do not eject the memory card or remove or disconnect the power source until the lamp has gone out and recording is complete.*



■ Turning the Camera Off

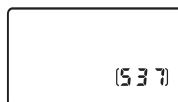
Turn the camera off when shooting is complete.

Power switch



✎ Camera Off Display

If the camera is turned off with a battery and memory card inserted, the number of exposures remaining will be displayed in the control panel.

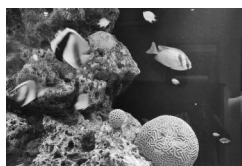


✎ Auto (Flash off) Mode

Choose this mode where flash photography is prohibited, when photographing infants, or to capture natural lighting under low light conditions.




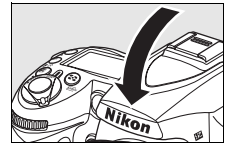
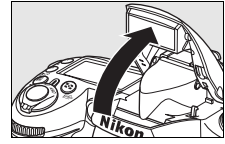
AUTO mode



mode

The Built-in Flash

If additional lighting is required for correct exposure in **AUTO** mode, the built-in flash will pop up automatically when the shutter-release button is pressed halfway. Flash range varies with aperture and ISO sensitivity (pg. 266); remove lens hoods when using the flash. If the flash is raised, photographs can only be taken when the flash-ready indicator () is displayed. If the flash-ready indicator is not displayed, the flash is charging; remove your finger briefly from the shutter-release button and try again.








To save battery power when the flash is not in use, return it to its closed position by pressing it gently downward till the latch clicks into place. For more information on using the flash, see page 70.

Creative Photography (Scene Modes)

The camera offers a choice of six “scene” modes. Selecting a program automatically optimizes settings to suit the selected scene, making creative photography as easy as rotating the mode dial.



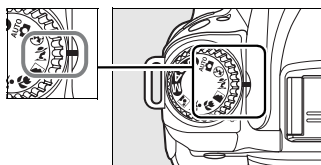
Mode	Description
 Portrait	For portraits.
 Landscape	For natural and man-made landscapes in daylight or at night.
 Close up	For close up shots of flowers, insects, and other small objects.
 Sports	For moving subjects.
 Night portrait	For portraits taken under low light.

To take photographs in scene modes:

1 Select the desired mode.

Rotate the mode dial to select a scene mode.

Mode dial



2 Take photographs.

Frame a photograph, focus, and shoot.



Portrait

Use for portraits with soft, natural-looking skin tones. If the subject is far from the background or a telephoto lens is used, background details will be softened to lend the composition a sense of depth.



Landscape

Use for vivid landscape shots in daylight or at night. The built-in flash and AF-assist illuminator turn off automatically. Use of a tripod is recommended to prevent blur when lighting is poor.



Close Up

Use for close-up shots of flowers, insects, and other small objects (a macro lens can be used to focus at very close ranges). The camera automatically focuses on the subject in the center focus point. Use of a tripod is recommended to prevent blur.



Sports

High shutter speeds freeze motion for dynamic sports shots in which the main subject stands out clearly. The built-in flash and AF-assist illuminator turn off automatically.








Night Portrait

Use for a natural balance between the main subject and the background in portraits taken under low light. Use of a tripod is recommended to prevent blur.






Focus Point

At default settings, the camera selects the focus point as follows:

- , , and  modes: The camera selects the focus point automatically.
-  mode: The camera focuses on the subject in the center focus point. Other focus points can be selected with the multi selector (pg. 56).
-  mode: The camera focuses continuously while the shutter-release button is pressed halfway, tracking the subject in the center focus point. If the subject leaves the center focus point, the camera will continue to focus based on information from the other focus points. The starting focus point can be selected with the multi selector (pg. 56).

The Built-in Flash

If additional lighting is required for correct exposure in , , or  mode, the built-in flash will pop automatically when the shutter-release button is pressed halfway.

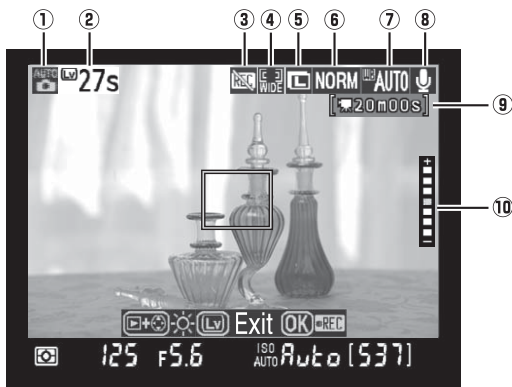
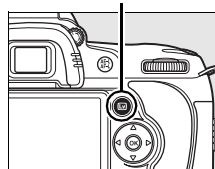
Framing Pictures in the Monitor (Live View)

Press the **Lv** button to frame pictures in the monitor.

1 Press the **Lv** button.

The mirror will be raised and the view through the lens will be displayed in the camera monitor. The subject will no longer be visible in the viewfinder.

Lv button



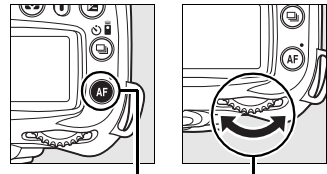
Item	Description	Page
① Shooting mode	The mode currently selected with the mode dial.	34, 41, 78
② Time remaining	The amount of time remaining before live view ends automatically. Displayed if shooting will end in 30 s or less.	46
③ “No movie” icon	Indicates that movies can not be recorded.	50
④ Autofocus mode	The current autofocus mode.	44
⑤ Image size	The option currently selected for image size.	63
⑥ Image quality	The option currently selected for image quality.	62
⑦ White balance	The option currently selected for white balance.	95
⑧ Audio recording indicator	Indicates whether sound is being recorded with movies.	170
⑨ Time remaining (movie mode)	The recording time remaining in movie mode.	50
⑩ Monitor brightness	To adjust monitor brightness, press the ▶ button during live view.	44

Before Selecting Live View




Note that metering can not be changed in live view mode. Choose a metering method before selecting live view mode.

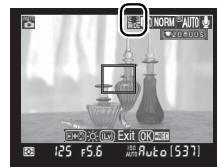
2 Choose an autofocus mode.

Press the **AF** button and rotate the command dial until one of the following autofocus modes is displayed in the monitor (note that these autofocus modes differ from those available in other shooting modes):




AF button Main command dial

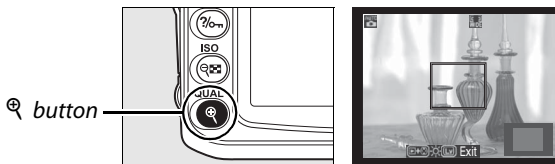
Mode	Description
 Face priority	The camera automatically detects and focuses on portrait subjects facing the camera. Use for portraits.
 Wide area (default)	Use for hand-held shots of landscapes and other non-portrait subjects. The focus point can be selected using the multi selector.
 Normal area	Use for pin-point focus on a selected spot in the frame. A tripod is recommended.






Monitor





3 Check the view in the monitor.

To magnify the view in the monitor and check focus, press the  button.



Press  to zoom in up to a maximum of 6.7 \times , or press  to zoom out. While the view through the lens is zoomed in, a navigation window will appear in a gray frame at the bottom right corner of the display. Use the multi selector to scroll to areas of the frame not visible in the monitor. Press the  button to start recording (pg. 50).

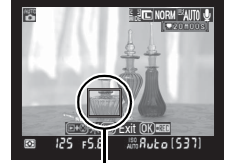
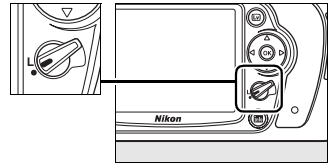
Monitor Brightness

Monitor brightness can be adjusted by pressing the  button while the view through the monitor is displayed. Press  or  to adjust brightness (note that monitor brightness has no effect on pictures taken in live view mode). To return to live view, release the  button.

4 Choose the focus point.

Wide and normal area autofocus: Rotate the focus selector lock to “●” and use the multi selector to move the focus point to any point in the frame. Return the focus selector lock to “L” when selection is complete.

Focus selector lock



Focus point

Face-priority autofocus: A double yellow border will be displayed when the camera detects a portrait subject facing the camera (if multiple faces, up to a maximum of five, are detected, the camera will focus on the closest subject).

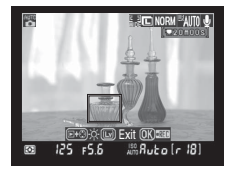


Focus point

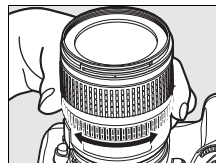
Manual focus: Use the multi selector to choose the focus point for electronic rangefinding (pg. 59) as described for wide and normal area autofocus, above.

5 Focus.

Autofocus: In *wide and normal area autofocus*, the camera will focus while the shutter-release button is pressed halfway. In *face-priority autofocus*, the camera sets focus and exposure for the face in the double yellow border while the shutter-release button is pressed halfway; if the camera can no longer detect the subject (because, for example, the subject has looked away), borders will no longer be displayed. The focus point will blink green and the monitor may brighten or darken while the camera focuses. If the camera is able to focus, the focus point will be displayed in green; if the camera is unable to focus, the focus point will blink red. Note that pictures can be taken even when the focus point blinks red, and that single-servo autofocus is used regardless of the option selected for autofocus mode (pg. 54). Check focus in the monitor before shooting.



Manual focus: Focus using the lens focusing ring.




6 Take the picture.

Press the shutter-release button the rest of the way down to take pictures in the current release mode (pg. 64). The monitor will turn off. When shooting is complete, the photograph will be displayed in the monitor for 4 s or until the shutter-release button is pressed halfway. The camera will then return to live view mode.



7 Exit live view mode.

Press the  button to exit live view mode.

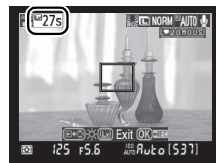
Shooting in Live View Mode

Although they will not appear in the final picture, banding or distortion may be visible in the monitor under fluorescent, mercury vapor, or sodium lamps or if the camera is panned horizontally or an object moves at high speed through frame. Bright light sources may leave after-images in the monitor when the camera is panned. Bright spots may also appear. When shooting in live view mode, avoid pointing the camera at the sun or other strong light sources. Failure to observe this precaution could result in damage to the camera's internal circuitry.

The effects of aperture on depth of field can not be previewed in live view mode but are visible in the final photograph.

Live view shooting ends automatically if the lens is removed.

Live view mode can be used for up to an hour. Note, however, that when used in live view mode for extended periods, the temperature of the camera's internal circuits may rise, resulting in image noise and unusual colors (the camera may also become noticeably warm, but this does not indicate a malfunction). To prevent damage to the camera's internal circuits, live view shooting will end automatically before the camera overheats. A count-down display will appear in the monitor 30 s before shooting ends. At high ambient temperatures, this display may appear immediately when live view mode is selected.



To reduce blur when using a tripod, choose **On** for Custom Setting d10 (**Exposure delay mode**).

Exposure Lock and Exposure Compensation

Exposure can be locked by pressing the **AE-L/AF-L** button (pg. 88) or (in **P**, **S**, **A**, and **M** modes) altered using exposure compensation (pg. 90). The effects of exposure compensation are visible in the monitor during live view.

✔ Face-Priority AF

The camera's ability to detect faces depends on a variety of factors, including whether or not the subject is facing the camera. The camera may be unable to detect subjects that are not facing the camera or faces that are hidden by sunglasses or other obstructions or that take up too much or too little of the frame. If no face is detected when the shutter-release button is pressed halfway, the camera will focus on the subject in the center of the frame.

The camera will continue to focus until a face is detected or the shutter-release button is pressed halfway. If a flashing double red border is displayed, the camera is unable to focus; recompose the picture and try again.

✔ Using Autofocus in Live View

Autofocus is slower in live view. The camera may be unable to focus in the following situations:

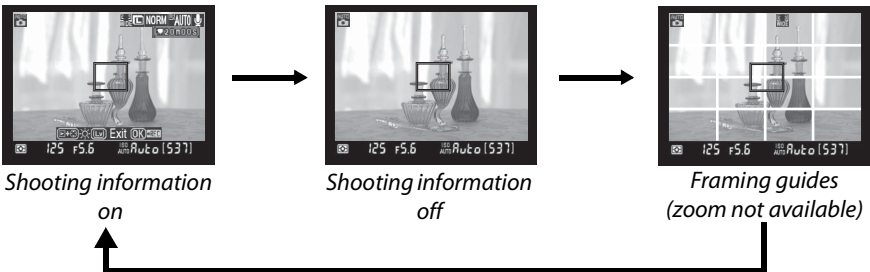
- The subject contains lines parallel to the long edge of the frame
- The subject lacks contrast
- The subject in the focus point contains areas of sharply contrasting brightness, or the subject is lit by spot lighting or by a neon sign or other light source that changes in brightness
- A cross (star) filter or other special filter is used
- The subject appears smaller than the focus point
- The subject is dominated by regular geometric patterns (e.g., windows in a skyscraper)
- The subject is moving

Note that the focus point may sometimes be displayed in green when the camera is unable to focus.

Use an AF-S lens. The desired results may not be achieved with other lenses or teleconverters.

✍ The Shooting Information Display

To hide or display indicators in the monitor in live view mode, press the **Info** button.




✍ HDMI

When the camera is attached to an HDMI video device, the camera monitor will turn off and the video device will display the view through the lens as shown at right.




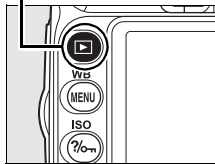
Basic Playback

At default settings, photographs are automatically displayed for about 4 s after shooting. If no photograph is displayed in the monitor, the most recent picture can be viewed by pressing the  button.





1 Press the button.

A photograph will be displayed in the monitor.

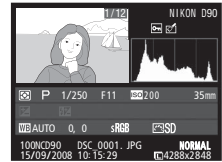
 button



2 View additional pictures.

Additional pictures can be displayed by pressing  or . To view additional information on the current photograph, press  and .

To end playback and return to shooting mode, press the shutter-release button halfway.



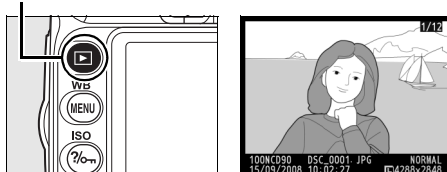
Deleting Unwanted Photographs

To delete the photograph currently displayed in the monitor, press the  button. Note that photographs can not be recovered once deleted.

1 Display the photograph.

Display the photograph you wish to delete as described on the previous page.

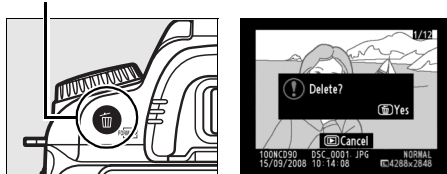
 button





2 Delete the photograph.

Press the  button. A confirmation dialog will be displayed.

 button



Press the  button again to delete the image and return to playback. To exit without deleting the picture, press .

Delete

To delete multiple images, use the **Delete** option in the playback menu (pg. 162).

Recording and Viewing Movies (Live View)

Movies up to 2 GB in size can be recorded in live view mode. Before recording, choose frame size and sound options in the **Movie settings** menu (pg. 170).

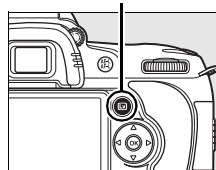
1 Press the **Lv** button.

The mirror will be raised and the view through the lens will be displayed in the camera monitor. The subject will no longer be visible in the viewfinder.

✓ The **Low Space** Icon

A **Low Space** icon (pg. 43) will be displayed if there is insufficient space on the memory card to record movies.

Lv button



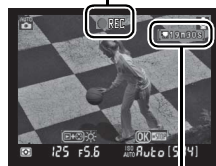
2 Focus.

Frame the opening shot and press the shutter-release button halfway to focus on your subject.

3 Start recording.

Press the **OK** button to start recording (at default settings, both video and sound be recorded; do not cover the microphone on the front of the camera during recording). The recording time available is displayed in the monitor, together with a recording indicator. Exposure can be locked by pressing the **AE-L/AF-L** button (pg. 88) or (in **P**, **S**, **A**, and **M** modes) altered using exposure compensation (pg. 90). Note that camera will not focus if the shutter-release button is pressed halfway during recording.

Recording indicator



Time remaining

4 End recording.

To end recording, press the **OK** button (to end recording and take a still picture in the mode currently selected with the mode dial, press the shutter-release button all the way down). Recording will end automatically when the maximum size is reached or the memory card is full.



✓ **Maximum Size**

Movie files can be up to 2 GB in size. The maximum length is 5 min for movies with a frame size of 1280 × 720, 20 min for other movies; note that depending on memory card write speed, shooting may end before this length is reached.

✔ Recording Movies

Banding or distortion may be visible in the monitor and in the final movie under fluorescent, mercury vapor, or sodium lamps or if the camera is panned horizontally or an object moves at high speed through frame. Bright light sources may leave after-images when the camera is panned. Jagged edges, false colors, moiré, and bright spots may also appear. When recording movies, avoid pointing the camera at the sun or other strong light sources. Failure to observe this precaution could result in damage to the camera's internal circuitry.


Recording ends automatically if the lens is removed.

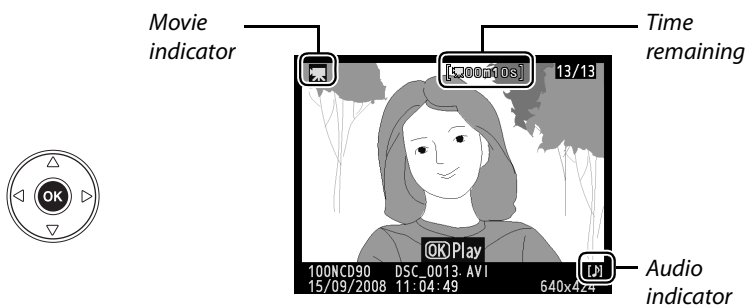
Live view can be used to record movies for up to an hour. Note, however, that when used in live view mode for extended periods, the temperature of the camera's internal circuits may rise, resulting in image noise and unusual colors (the camera may also become noticeably warm, but this does not indicate a malfunction). To prevent damage to the camera's internal circuits, recording will end automatically before the camera overheats. A count-down display will appear in the monitor 30 s before shooting ends. At high ambient temperatures, this display will appear immediately when live view mode is selected.















Autofocus is not available when recording movies. Matrix metering is used regardless of the metering method selected.



■ Viewing Movies

Movies are indicated by a  icon in full-frame playback (pg. 128). The following operations can be performed while a movie is displayed:



To	Use	Description
Start/pause/resume		Press  to start, pause, or resume playback.
Advance/rewind		Press  or  to rewind or fast forward. While playback is paused, press  or  to rewind or advance one frame.
Adjust volume		Press  to increase volume,  to decrease.
Exit to shooting mode		Monitor will turn off. Photographs can be taken immediately.
Display menus	MENU	See page 159 for more information.
Return to full-frame playback	 / 	Press the selector up or press  to exit to full-frame playback.



More on Photography (All Modes)

This and the following two chapters build on the Tutorial to cover more advanced shooting and playback options.


Focus	54
Autofocus	54
Focus Point Selection	56
Focus Lock	57
Manual Focus.....	59
Image Quality and Size	61
Image Quality	62
Image Size.....	63
Release Mode	64
Continuous Mode	65
Self-Timer Mode (☺).....	66
Using an Optional Remote Control (Ⓜ)	68
Using the Built-in Flash	70
Flash Mode	71
ISO Sensitivity	74
Two-Button Reset	75



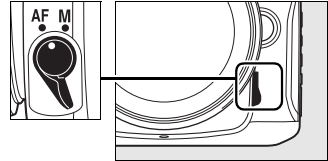
Focus

Focus can be adjusted automatically (see “Autofocus,” below) or manually (pg. 59). The user can also select the focus point for automatic or manual focus (pg. 59) or use focus lock to focus to recompose photographs after focusing (pg. 57).

Autofocus

When the focus mode selector is set to **AF**, the camera focuses automatically when the shutter-release button is pressed halfway. In single-point AF, a beep will sound when the camera focuses. No beep will sound when **AF-A** is selected in  (sports) mode or when continuous-servo autofocus is used (note that continuous-servo autofocus may be selected automatically when shooting moving subjects in **AF-A** autofocus mode).

Focus mode selector



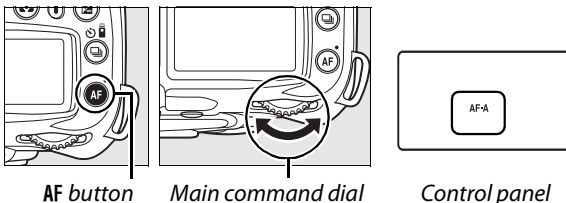
With lenses that offers A-M selection, select **A** when using autofocus. With lenses that support M/A (autofocus with manual priority), select **M/A**. If the lens does not support autofocus or the camera is unable to focus using autofocus, use manual focus (pg. 59).

Autofocus Mode

The following autofocus modes are available when the focus mode selector is set to **AF**:

Autofocus mode		Description
AF-A	Auto select (default setting)	Camera automatically selects single-servo autofocus when subject is stationary, continuous-servo autofocus when subject is moving. Shutter can only be released if camera is able to focus.
AF-S	Single-servo AF	For stationary subjects. Focus locks when shutter-release button is pressed halfway. Shutter can only be released when in-focus indicator is displayed.
AF-C	Continuous-servo AF	For moving subjects. Camera focuses continuously while shutter-release button is pressed halfway. Photographs can be taken even when in-focus indicator is not displayed.

To choose the autofocus mode, press the **AF** button. The focus mode changes each time the **AF** button is pressed.



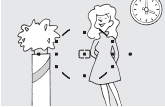
AF button

Main command dial

Control panel

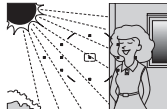
Getting Good Results with Autofocus

Autofocus does not perform well under the conditions listed below. The shutter release may be disabled if the camera is unable to focus under these conditions, or the in-focus indicator (●) may be displayed and the camera may sound a beep, allowing the shutter to be released even when the subject is not in focus. In these cases, rotate the focus mode selector to **M** and use manual focus (pg. 59), or use focus lock (pg. 57) to focus on another subject at the same distance and then recompose the photograph.



There is little or no contrast between the subject and the background.

Example: Subject is the same color as the background.



The focus point contains areas of sharply contrasting brightness.

Example: Subject is half in the shade.



The focus point contains objects at different distances from the camera.

Example: Subject is inside a cage.



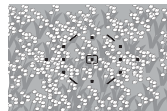
Background objects appear larger than the subject.

Example: a building is in the frame behind the subject.



The subject is dominated by regular geometric patterns.



Example: A row of windows in a skyscraper.



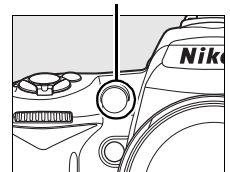
The subject contains many fine details.

Example: A field of flowers or other subjects that are small or lack variation in brightness.

The AF-Assist Illuminator

If the subject is poorly lit, the AF-assist illuminator will light automatically to assist the autofocus operation when the shutter-release button is pressed halfway. The AF-assist illuminator will not light in  or  modes or if **Off** has been selected for Custom Setting a3 (**Built-in AF-assist illuminator**; pg. 174). The illuminator has a range of about 0.5–3.0 m (1 ft. 8 in.–9 ft. 10 in.); when using the illuminator, use a lens with a focal length of 24–200 mm and remove the lens hood.

AF-assist illuminator



See Also

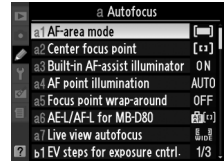
Custom Setting d1 (**Beep**; pg. 180) can be used to turn the beep speaker on or off.

Focus Point Selection

The camera offers a choice of eleven focus points that together cover a wide area of the frame. At the default settings, the camera chooses the focus point automatically or focuses on subject in the center focus point. The focus point can also be selected manually to compose photographs with the main subject positioned almost anywhere in the frame.

1 Choose single- or dynamic-area AF.

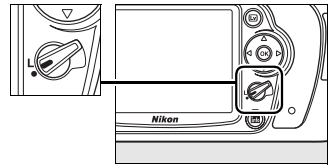
At default settings, the focus point is selected automatically in **AUTO**, **AF-ON**, **AF-L**, **AF-ON**, **P**, **S**, **A**, and **M** modes. To enable manual focus-point selection in these modes, select **Single point**, **Dynamic area**, or **3D-tracking (11 points)** for Custom Setting a1 (**AF-area mode**; pg. 173).



2 Set the focus selector lock to “●”.

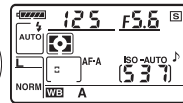
Set the focus selector lock to the “●” position. This allows the multi selector to be used to select the focus point.

Focus selector lock



3 Select the focus point.

Use the multi selector to select the focus point in the viewfinder or control panel while the exposure meters are active (pg. 35). The focus selector lock can be returned to the “L” (locked) position following selection to prevent the selected focus point from changing when the multi selector is pressed.



See Also

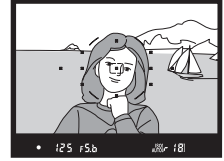
Custom Setting a1 (**AF-area mode**; pg. 173) controls how the camera selects the focus point. Custom Setting a2 (**Center focus point**; pg. 174) controls the size of the center focus point. Custom Setting a4 (**AF point illumination**; 175) controls whether the active focus point is highlighted in the viewfinder.

Focus Lock

Focus lock can be used to change the composition after focusing, making it possible to focus on a subject that will not be in a focus point in the final composition. It can also be used when the autofocus system is unable to focus (pg. 55). Focus lock is most effective when **Single point**, **Dynamic area**, or **3D-tracking (11 points)** is selected for Custom Setting a1 (**AF-area mode**; pg. 173).

1 Focus.

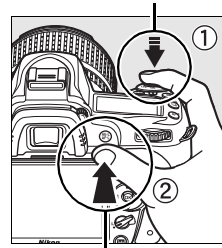
Position the subject in the selected focus point and press the shutter-release button halfway to initiate focus. Check that the in-focus indicator (●) appears in the viewfinder.



2 Lock focus.

AF-A and AF-C autofocus modes (pg. 54): With the shutter-release button pressed halfway (①), press the **AE-L/AF-L** button (②) to lock both focus and exposure (an **AE-L** icon will be displayed in the viewfinder). Focus will remain locked while the **AE-L/AF-L** button is pressed, even if you later remove your finger from the shutter-release button.

Shutter-release button



AE-L/AF-L button

AF-S autofocus mode (pg. 54): Focus will lock automatically when the in-focus indicator appears, and remain locked until you remove your finger from the shutter-release button. Focus can also be locked by pressing the **AE-L/AF-L** button (see above).

3 Recompose the photograph and shoot.

Focus will remain locked between shots if you keep the **AE-L/AF-L** button pressed (**AF-A/AF-C**) or the shutter-release button pressed halfway (**AF-S**), allowing several photographs in succession to be taken at the same focus setting.



Do not change the distance between the camera and the subject while focus lock is in effect. If the subject moves, focus again at the new distance.



 **Continuous Mode (pg. 65)**

Use the **AE-L/AF-L** button to lock focus in continuous mode.

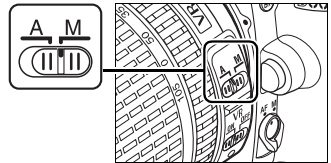
 **See Also**

Custom Setting f4 (**Assign AE-L/AF-L Button**; pg. 200) controls the behavior of the **AE-L/AF-L** button.

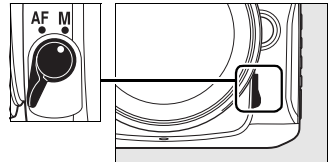
Manual Focus

Manual focus is available for lenses that do not support autofocus (non-AF Nikkor lenses) or when autofocus does not produce the desired results (pg. 55). To use manual focus, set the camera focus-mode selector and/or the lens focus-mode switch as follows:

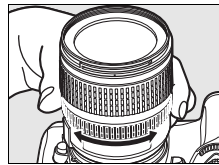
- **AF-S lenses:** Set the lens focus-mode switch to **M**.
- **AF lenses:** Set the both the camera focus-mode selector and the lens focus-mode switch to **M**.
- **Manual focus lenses:** Set the camera focus-mode selector to **M**.



Focus-mode selector



To focus manually, adjust the lens focusing ring until the image displayed on the clear matte field in the viewfinder is in focus. Photographs can be taken at any time, even when the image is not in focus.



✓ Using Manual Focus with AF Lenses

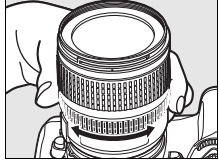
Be sure the camera focus-mode selector is set to **M** when using manual focus with AF lenses. Focusing manually with the focus-mode selector set to **AF** could damage the lens.

✓ AF-S DX Nikkor 18–105 mm f/3.5–5.6G VR Lenses (pg. 273)

Like other AF-S lenses, the AF-S DX Nikkor 18–105 mm f/3.5–5.6G VR lens used in this manual for illustrative purposes can be used for manual focus simply by setting the lens focus-mode switch to **M**.

■ The Electronic Rangefinder

If the lens has a maximum aperture of $f/5.6$ or faster, the viewfinder focus indicator can be used to confirm whether the subject in the selected focus point is in focus (the focus point can be selected from any of the 11 focus points). After positioning the subject in the selected focus point, press the shutter-release button halfway and rotate the lens focusing ring until the in-focus indicator (●) is displayed. Note that with the subjects listed on page 55, the in-focus indicator may sometimes be displayed when the subject is not in focus; confirm focus in the viewfinder before shooting.



✍ Focal Plane Position

To determine the distance between your subject and the camera, measure from the focal plane mark on the camera body. The distance between the lens mounting flange and the focal plane is 46.5 mm (1.83 in.).

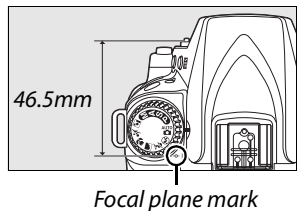
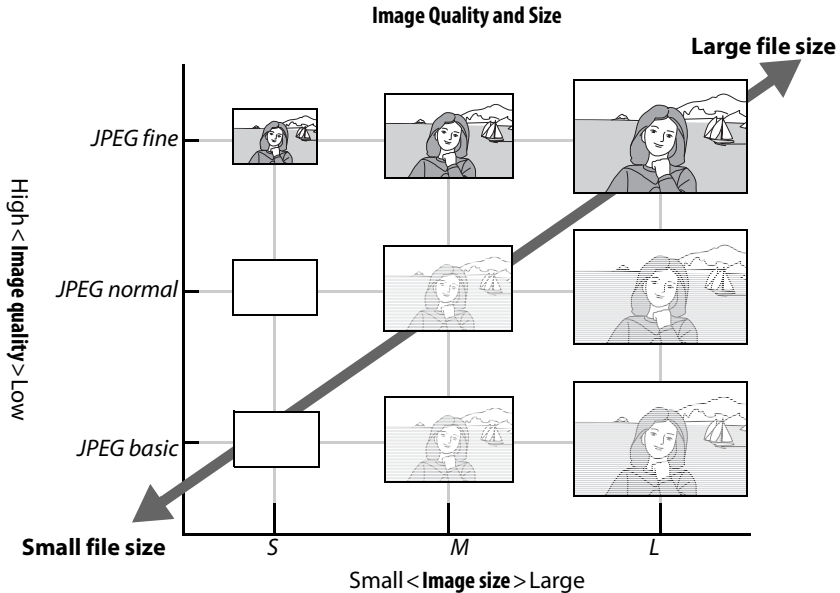


Image Quality and Size

Together, image quality and size determine how much space each photograph occupies on the memory card. Larger, higher quality images can be printed at larger sizes but also require more memory, meaning that fewer such images can be stored on the memory card.



Changes to image quality and size are reflected in the number of exposures remaining as displayed in the control panel and viewfinder (pg. 35).

File Names

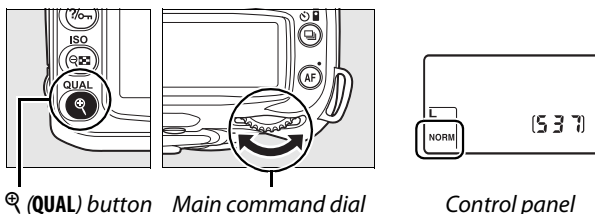
Photographs are stored as image files with names of the form "DSC_####.xxx," where #### is a four-digit number between 0001 and 9999 assigned automatically in ascending order by the camera, and xxx is one of the following three letter extensions: "NEF" for NEF images or "JPG" for JPEG images. The NEF and JPEG files recorded at a setting of "NEF+JPEG" have the same file names but different extensions. Small copies created with the small picture option in the retouch menu have file names beginning with "SSC_" and ending with the extension ".JPG" (e.g., "SSC_0001.JPG"), while images recorded with the other options in the retouch menu have file names beginning with "CSC" (e.g., "CSC_0001.JPG"). Images recorded at a **Shooting menu** > **Color space** > **Adobe RGB** (pg. 167) have names that begin with an underscore (e.g., "_DSC0001.JPG").

Image Quality

The camera supports the following image quality options (listed in descending order by image quality and file size):

Option	File type	Description
NEF (RAW)	NEF	Raw 12-bit data from the image sensor are saved directly to the memory card. Choose for images that will be processed on a computer. JPEG copies of NEF (RAW) images can be created using the NEF (RAW) processing option in the retouch menu (pg. 220) or software such as ViewNX (supplied) or Capture NX 2 (available separately; pg. 240).
JPEG fine	JPEG	Record JPEG images at a compression ratio of roughly 1 : 4 (fine image quality).
JPEG normal (default)		Record JPEG images at a compression ratio of roughly 1 : 8 (normal image quality).
JPEG basic		Record JPEG images at a compression ratio of roughly 1 : 16 (basic image quality).
NEF (RAW) + JPEG fine	NEF/ JPEG	Two images are recorded: one NEF (RAW) image and one fine-quality JPEG image.
NEF (RAW) + JPEG normal		Two images are recorded: one NEF (RAW) image and one normal-quality JPEG image.
NEF (RAW) + JPEG basic		Two images are recorded: one NEF (RAW) image and one basic-quality JPEG image.

Image quality can be set by pressing the **QUAL** button and rotating the main command dial until the desired setting is displayed in the control panel. Image quality can also be adjusted from the shooting menu (pg. 165).



NEF (RAW) Images

Note that the option selected for image size does not affect the size of NEF (RAW) images. When opened in software such as Capture NX 2 (available separately) or ViewNX (supplied), NEF (RAW) images have the dimensions given for large (L-size) images.

NEF (RAW)/NEF+JPEG

When photographs taken at **NEF (RAW) + JPEG Fine**, **NEF (RAW) + JPEG Normal**, or **NEF (RAW) + JPEG Basic** are viewed on the camera, only the JPEG image will be displayed. When photographs taken at these settings are deleted, both NEF and JPEG images will be deleted.

White balance bracketing (pg. 191) is not available when an NEF (RAW) + JPEG option is selected for image quality. Selecting an NEF (RAW) + JPEG option cancels white balance bracketing.

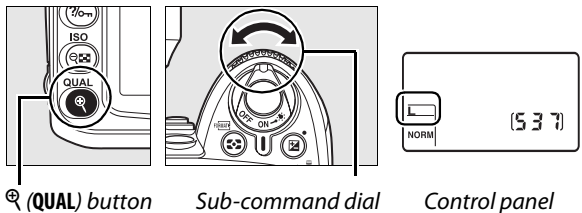
Image Size

Image size is measured in pixels. The following options are available.

Image size	Size (pixels)	Approximate size when printed at 200 dpi*
L (default)	4,288 × 2,848	54.5 × 36.2 cm (21.4 × 14.2 in.)
M	3,216 × 2,136	40.8 × 27.1 cm (16.1 × 10.7 in.)
S	2,144 × 1,424	27.2 × 18.1 cm (10.7 × 7.1 in.)

* Approximate size when printed at 200 dpi. Print size in inches equals image size in pixels divided by printer resolution in dots per inch (dpi; 1 inch = approximately 2.54 cm). Print size decreases as printer resolution increases.

Image size can be set by pressing the **QUAL** button and rotating the sub-command dial until the desired setting is displayed in the control panel. Image size can also be adjusted from the shooting menu (pg. 165).









Note that the option selected for image size does not affect the size of NEF (RAW) images. When viewed on a computer, NEF images are 4,288 × 2,848 pixels in size.




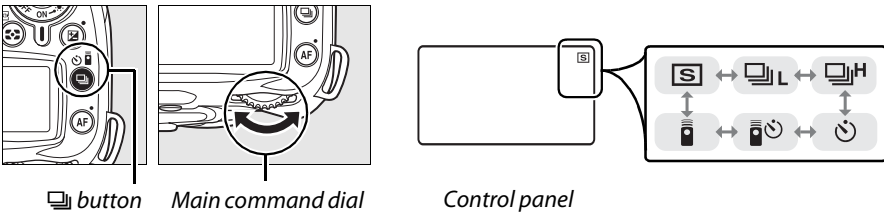
Release Mode

Release mode determines how the camera takes photographs: one at a time, in a continuous sequence, with a timed shutter-release delay, or with a remote control.

Mode	Description
 Single frame	Camera takes one photograph each time shutter-release button is pressed. Access lamp will light while photo is recorded; next shot can be taken immediately if enough space remains in memory buffer.
 Continuous low speed	Camera records 1–4 frames per second while shutter-release button is held down (pg. 65). * Frame rate can be chosen with Custom Setting d6 (CL mode shooting speed ; pg. 182).
 Continuous high speed	Camera records up to 4.5 frames per second while shutter-release button is held down (pg. 65). *
 Self-timer	Use for self-portraits or to reduce blurring caused by camera shake (pg. 66).
 Delayed remote	Optional ML-L3 remote control required. Use for self-portraits (pg. 68).
 Quick-response	Optional ML-L3 remote control required. Use to reduce blurring caused by remote camera shake (pg. 68).

* Average frame rate with an EN-EL3e battery, manual focus, manual or shutter-priority auto exposure, a shutter speed of $1/250$ s or faster, other settings (with the exception of Custom Setting d6 in the case of continuous low speed mode) at default values, and memory remaining in memory buffer.

To choose the release mode, press the  button and rotate the main command dial until the desired setting is displayed in the control panel.





The Memory Buffer


The camera is equipped with a memory buffer for temporary storage, allowing shooting to continue while photographs are being saved to the memory card. Up to 100 photographs can be taken in succession; note, however, that frame rate will drop when the buffer is full.

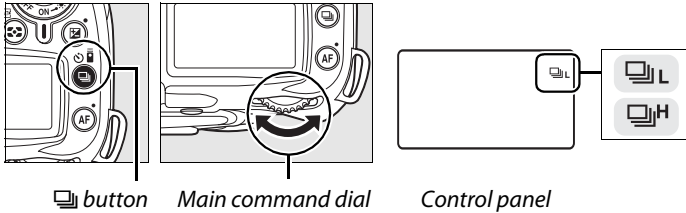
While photographs are being recorded to the memory card, the access lamp next to the memory card slot will light. Depending on the number of the images in the buffer, recording may take from a few seconds to a few minutes. *Do not remove the memory card or remove or disconnect the power source until the access lamp has gone out.* If the camera is switched off while data remain in the buffer, the power will not turn off until all images in the buffer have been recorded. If the battery is exhausted while images remain in the buffer, the shutter release will be disabled and the images transferred to the memory card.

Continuous Mode

To take pictures in  (continuous low speed) and  (continuous high speed) modes:

1 Select or mode.

Press the  button and rotate the main command dial until the desired setting is displayed in the control panel.



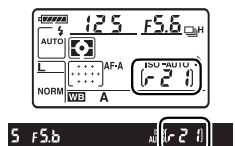
2 Frame a photograph, focus, and shoot.

While the shutter-release button is pressed all the way down, pictures will be taken at up to 4.5 fps in continuous high speed mode, or at the frame rate selected for Custom Setting d6 (**CL mode shooting speed**, pg. 182) in continuous low speed mode.



Buffer Size

The approximate number of images that can be stored in the memory buffer at current settings is shown in the exposure-count displays in the viewfinder and control panel while the shutter-release button is pressed. The illustration at right shows the display when space remains in the buffer for about 21 pictures.



Auto Image Rotation

The camera orientation recorded for the first shot applies to all images in the same burst, even if the camera is rotated during shooting. See "Auto Image Rotation" (pg. 205).

See Also

For information on the number of photographs that can be taken in a single burst, see page 262.


Self-Timer Mode (☺)

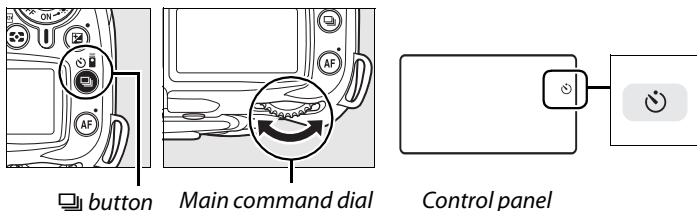
The self-timer can be used to reduce camera shake or for self-portraits.

1 Mount the camera on a tripod.



Mount the camera on a tripod or place the camera on a stable, level surface.

2 Select ☺ mode.

Press the  button and rotate the main command dial until ☺ is displayed in the control panel.

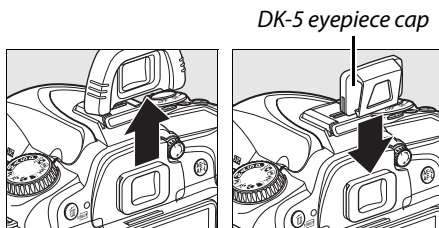


3 Frame the photograph.

Frame the photograph. Before taking a photograph with the flash in **P**, **S**, **A**, or **M** modes (pg. 78), press the  button to raise the flash and wait for the  indicator to be displayed in the viewfinder (pg. 70). The timer will stop if the flash is raised after the timer has started.

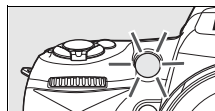
Cover the Viewfinder

After framing the photograph, remove the viewfinder eyepiece cup and insert the supplied DK-5 eyepiece cap as shown. This prevents light entering via the viewfinder interfering with exposure.



4 Start the timer.

Press the shutter-release button halfway to focus, and then press the button the rest of the way down to start the self-timer. The self-timer lamp will start to blink and a beep will begin to sound. Two seconds before the photograph is taken, the self-timer lamp will stop blinking and the beeping will become more rapid. At default settings, the shutter will be released ten seconds after the timer starts.



The timer will not start if the camera is unable to focus or in other situations in which the shutter can not be released.

The self-timer can be cancelled by selecting another release mode. Turning the camera off cancels self-timer mode and restores single frame or continuous mode.



Bulb

In self-timer mode, a shutter speed of **b** \downarrow **b** is equivalent to approximately $1/10$ s.

See Also

For information on changing the timer duration and choosing the number of shots taken, see Custom Setting c3 (**Self-timer**, pg. 179). For information on setting a beep to sound as the timer counts down, see Custom Setting d1 (**Beep**, pg. 180).

Using an Optional Remote Control (Ⓜ)

Use the optional ML-L3 remote control for self-portraits (pg. 241) or to operate the camera remotely.


✔ Before Using the Remote Control

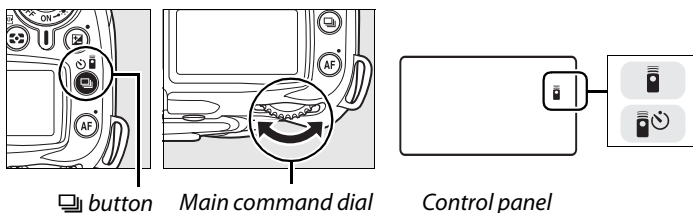
Before using the remote control for the first time, remove the clear plastic battery insulator sheet.



1 Mount the camera on a tripod.

Mount the camera on a tripod or place the camera on a stable, level surface.

2 Select or mode.

Press the  button and rotate the main command dial to select one of the following modes:



Mode	Description
 Delayed remote	Shutter released about 2 s after remote shutter-release button is pressed.
 Quick-response remote	Shutter released when remote shutter-release button is pressed.

The camera will enter stand-by mode. At default settings, single frame or continuous mode will be restored if no operations are performed for about a minute.

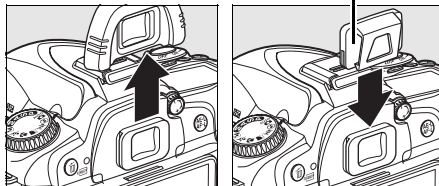
3 Frame the photograph.

Frame the photograph. If autofocus is in effect, the camera shutter-release button can be used to set focus, although only the shutter-release button on the remote control can be used to release the shutter.

4 Cover the viewfinder

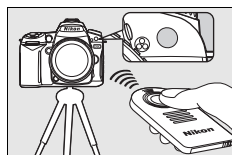
After framing the photograph, remove the viewfinder eyepiece cup and insert the supplied DK-5 eyepiece cap as shown. This prevents light entering via the viewfinder interfering with exposure.

DK-5 eyepiece cap







5 Take the photograph.

Aim the transmitter on the ML-L3 at the infrared receiver on the camera and press the shutter-release button on the ML-L3. In delayed remote mode, the self-timer lamp will light for about two seconds before the shutter is released. In quick-response remote mode, the self-timer lamp will flash after the shutter has been released. In **AF-A** or **AF-S** is selected in autofocus modes (pg. 54), the camera will return to stand-by mode without releasing the shutter if unable to focus. The camera will release the shutter without focusing in manual focus mode, if **AF-C** is selected in autofocus mode, or if the camera has already been focused using the camera shutter-release button (see step 3).



Remote control mode can be cancelled by selecting another release mode. Single-frame or continuous mode will be restored if the camera is turned off or no operations are about one minute.

Using the Built-in Flash

If the flash is required, the camera will only respond to the shutter-release button on the ML-L3 once the flash has charged. In , , , and  modes, the flash will begin charging when delayed remote or quick-response remote mode is selected; once the flash is charged, it will automatically pop up and fire if required when the shutter-release button on the ML-L3 is pressed. In **P**, **S**, **A**, and **M** modes, raising the flash during the two-second count-down in delayed remote mode will cancel the two-second timer. Wait for the flash to charge and then press the shutter-release button on the ML-L3 to restart the timer.

In flash-sync modes that support red-eye reduction, the red-eye reduction lamp will light for about one second before the shutter is released. In delayed remote mode, the self-timer lamp will light for two seconds, followed by the red-eye reduction lamp, which lights for one second before the shutter is released to reduce red-eye.

See Also

For information on choosing the length of time the camera will remain in stand-by mode before remote control mode is cancelled, see Custom Setting c5 (**Remote on duration**, pg. 180). For information on controlling the beeps that sound when the remote control is used, see Custom Setting d1 (**Beep**, pg. 180).

Using the Built-in Flash


The camera supports a variety of flash modes for photographing poorly lit or backlit subjects.

■ ■ Using the Built-in Flash: , , , and Modes

1 Choose a shooting mode.

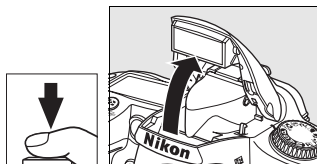
Rotate the mode dial to select the desired mode.

2 Choose a flash mode.

Press the  button and rotate until the desired flash mode is displayed in the control panel (pg. 71).

3 Take pictures.

The flash will pop up as required when the shutter-release button is pressed halfway, and fire when a photograph is taken.




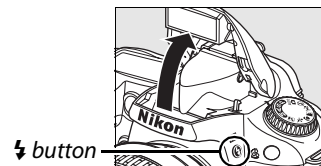
■ ■ Using the Built-in Flash: *P, S, A, and M Modes*

1 Choose a shooting mode.


Rotate the mode dial to select the desired mode.

2 Raise the flash.

Press the  button to raise the flash.



3 Choose a flash mode.


Press the  button and rotate until the desired flash mode is displayed in the control panel (pg. 71).

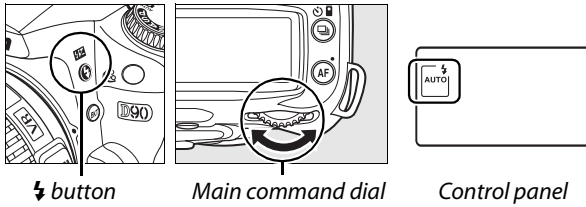
4 Select a metering method and set exposure.

5 Take pictures.

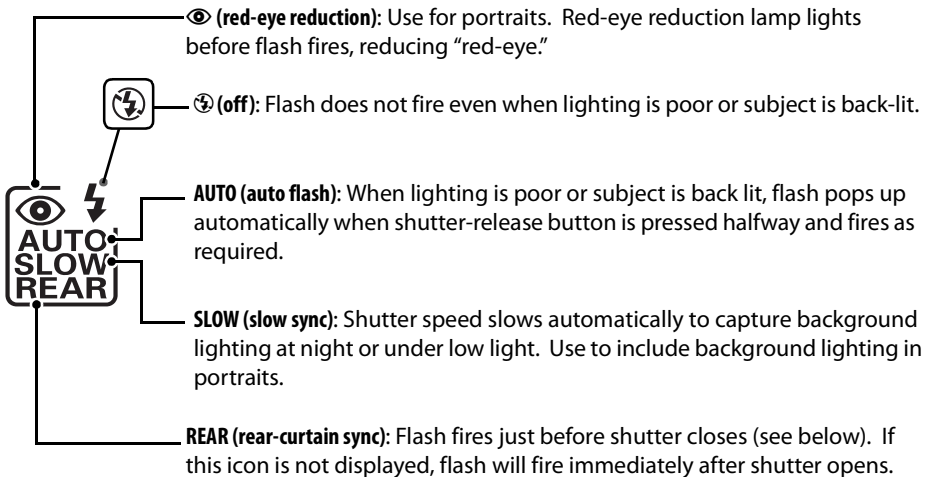
The flash will fire whenever a picture is taken.

Flash Mode

Press the  button and rotate the main command dial until the desired flash mode is displayed in the control panel.



The current flash mode is displayed in the control panel as shown below.



Rear-Curtain Sync

Normally the flash fires as the shutter opens (“front-curtain sync”; see below at left). In rear-curtain sync, the flash fires just before the shutter closes, creating the effect of a stream of light behind moving subjects.

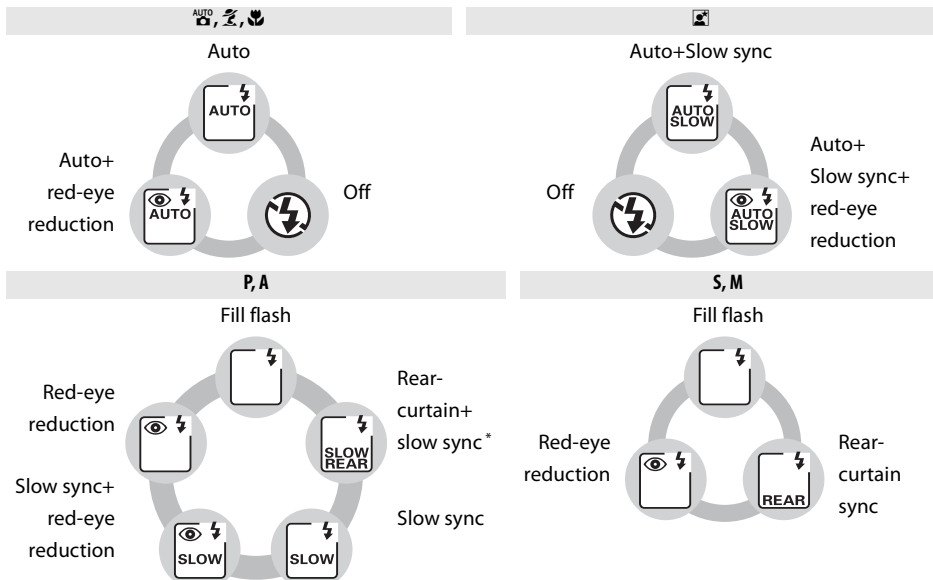


Front-curtain sync



Rear-curtain sync

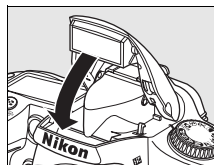
The flash modes available depend on the mode currently selected with the mode dial.



* **SLOW** is displayed after main ⚡ button is released.



■ Lowering the Built-in Flash

To save power when the flash is not in use, press it gently downward until the latch clicks into place.



The Built-in Flash

Use with CPU lenses with focal lengths of 18–300 mm or non-CPU lenses with focal lengths of 18–200 mm (pg. 232; note that auto flash level control is available with CPU lenses only). Remove lens hoods to prevent shadows. Lenses that block the subject's view of the red-eye reduction lamp may interfere with red-eye reduction. The flash has a minimum range of 60 cm (2 ft.) and can not be used in the macro range of macro zoom lenses.

If the flash fires in L or H mode (pg. 65), only one picture will be taken each time the shutter-release button is pressed.

The shutter release may be briefly disabled to protect the flash after it has been used for several consecutive shots. The flash can be used again after a short pause.

See Also

See page 198 for information on locking flash value (FV) for a metered subject before recomposing a photograph.


For information on choosing the slowest shutter speed available when using the flash, see Custom Setting e1 (**Flash shutter speed**, pg. 185). For information on using the built-in flash in commander mode, see Custom Setting e2 (**Flash cntrl for built-in flash**, pg. 185). For information on previewing the effects of the flash, see Custom Setting e3 (**Modeling flash**, pg. 191).

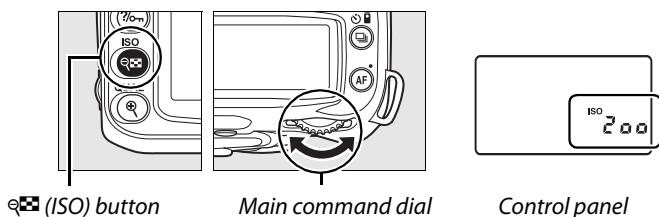
See the Appendix for more about the built-in flash, including flash control (pg. 265), shutter sync speeds (pg. 265), and range (pg. 266). For information on optional flash units, see pg. 233.

ISO Sensitivity

“ISO sensitivity” is the digital equivalent of film speed. The higher the ISO sensitivity, the less light needed to make an exposure, allowing higher shutter speeds or smaller apertures.

ISO sensitivity can be set between values roughly equivalent to ISO 200 and ISO 3200 in steps equivalent to $\frac{1}{3}$ EV. For special situations, ISO sensitivity can be lowered below ISO 200 by about 0.3 EV (L **0.3**, equivalent to ISO 160), 0.7 EV (L **0.7**, equivalent to ISO 125), or 1.0 EV (L **1.0**, equivalent to ISO 100), or raised above ISO 3200 by about 0.3 EV (H **0.3**, equivalent to ISO 4000), 0.7 EV (H **0.7**, equivalent to ISO 5000), or 1.0 EV (H **1.0**, equivalent to ISO 6400). Auto and scene modes also offer an **AUTO** option (the default setting), which allows the camera to set ISO sensitivity automatically in response to lighting conditions. **ISO-AUTO** is displayed in the control panel and viewfinder when **AUTO** is selected.

ISO sensitivity can be selected by pressing the  (**ISO**) button and rotating the main command dial until the desired setting is displayed in the control panel. ISO sensitivity can also be adjusted from the shooting menu (pg. 165).



AUTO

If the mode dial is rotated to **P**, **S**, **A**, or **M** after **ISO-AUTO** is selected for ISO sensitivity in another mode, the ISO sensitivity last selected in **P**, **S**, **A**, or **M** mode will be restored.


HI 0.3–HI 1


Pictures taken at these settings are more likely to be subject to noise and color distortion.

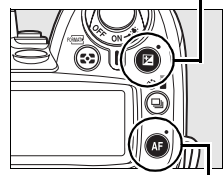
See Also

For information on enabling auto ISO sensitivity control in **P**, **S**, **A**, or **M** modes, see page 78. For information on using the **High ISO NR** option in the shooting menu to reduce noise at high ISO sensitivities, see page 165.




Two-Button Reset



The camera settings listed below can be restored to default values by holding the  and **AF** buttons down together for more than two seconds (these buttons are marked by a green dot). The control panel turns off briefly while settings are reset. Custom Settings are not affected.

 button



AF button

Option	Default
Image quality (pg. 62)	JPEG normal
Image size (pg. 63)	L
Release mode (pg. 64)	Single frame
ISO sensitivity (pg. 74)	
Auto and scene modes	AUTO
P, S, A, M	200
White balance (pg. 95)	Auto
Fine tuning (pg. 97)	0
Color temperature (pg. 99)	5000 K
Picture Control modifications (pg. 110)	None
Autofocus mode (pg. 54)	AF-A
Autofocus mode (live view)	
	Face-priority
 P, S, A, M	Wide area
	Normal area

Option	Default
Focus point (pg. 56) ¹	Center
Metering (pg. 87)	Matrix
AE/AF lock hold (pp. 88, 200)	Off
Flexible program (pg. 80)	Off
Exposure compensation (pg. 90)	Off
Flash compensation (pg. 91)	Off
Bracketing (pg. 92)	Off ²
FV lock (pg. 198)	Off
Flash mode (pg. 71)	
	Auto front-curtain sync
	Auto slow sync
P, S, A, M	Front curtain sync
Multiple exposure (pg. 121)	Off

- 1 Focus point not displayed if **Auto-area** is selected for Custom Setting a1 (**AF-area mode**).
- 2 Number of shots reset to zero. Bracketing increment reset to 1 EV (exposure/flash bracketing) or 1 (white balance bracketing).

Default Settings

See pages 258–261 for a list of default settings.







P, S, A, and M Modes

P, S, A, and **M** modes offer control over a variety of advanced settings, including shutter speed and aperture, metering, flash compensation, and white balance.

Shutter Speed and Aperture	78
Mode P (Programmed Auto)	80
Mode S (Shutter-Priority Auto)	81
Mode A (Aperture-Priority Auto)	82
Mode M (Manual)	83
Long Time-Exposures (M Mode Only)	85
Exposure	87
Metering	87
Autoexposure Lock (P, S, and A Modes Only)	88
Exposure Compensation	90
Flash Compensation	91
Exposure and Flash Bracketing	92
White Balance	95
Fine-Tuning White Balance	97
Choosing a Color Temperature	99
Preset Manual	100
Picture Controls	108
Selecting Nikon Picture Controls	109
Modifying Existing Picture Controls	110
Creating Custom Picture Controls	113
Sharing Custom Picture Controls	115
Managing Custom Picture Controls	117
Active D-Lighting	119
Multiple Exposure	121
The GP-1 GPS Unit	124



Shutter Speed and Aperture

P, **S**, **A**, and **M** modes offer different degrees of control over shutter speed and aperture:



Mode		Description
P	Programmed auto (pg. 80)	Camera sets shutter speed and aperture for optimal exposure. Recommended for snapshots and in other situations in which there is little time to adjust camera settings.
S	Shutter-priority auto (pg. 81)	User chooses shutter speed; camera selects aperture for best results. Use to freeze or blur motion.
A	Aperture-priority auto (pg. 82)	User chooses aperture; camera selects shutter speed for best results. Use to blur background or bring both foreground and background into focus.
M	Manual (pg. 83)	User controls both shutter speed and aperture. Set shutter speed to “ b ” or “ - ” for long time-exposures.

✓ Lens Aperture Rings

When using a CPU lens equipped with an aperture ring (pg. 228), lock the aperture ring at the minimum aperture (highest f-number). Type G lenses are not equipped with an aperture ring.

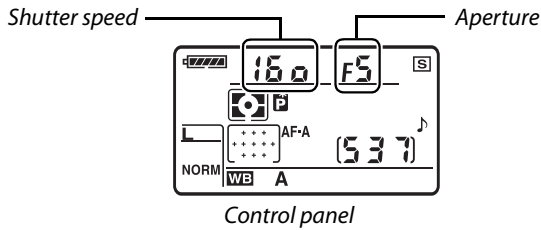
Non-CPU lenses can only be used in exposure mode **M**, when aperture can be adjusted manually using the lens aperture ring (in other modes, the shutter-release will be disabled). The camera exposure meter, auto ISO sensitivity control, and variety of other features can not be used (pg. 165).

✍ See also

Use the **ISO sensitivity auto control** option in the shooting menu (pg. 165) to enable auto ISO sensitivity control in **P**, **S**, **A**, and **M** modes. Custom Setting b1 (**EV steps for exposure cntrl.**; pg. 177) determines the size of the increments used for setting shutter speed and aperture. Custom Setting f5 (**Customize command dials**; pg. 201) determines the roles played by the main and sub-command dials in setting shutter speed and aperture.

Shutter Speed and Aperture

The same exposure can be achieved with different combinations of shutter speed and aperture. Fast shutter speeds and larger apertures freeze moving objects and soften background details, while slow shutter speeds and small apertures blur moving objects and bring out background details.



Fast shutter speed ($1/1,600$ s)



Slow shutter speed (1 s)



Small aperture (f/36)



Large aperture (f/3)

(Remember, the larger the f-number, the smaller the aperture.)

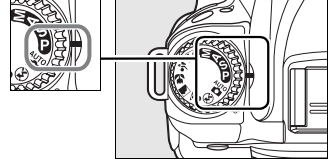


Mode P (Programmed Auto)

In this mode, the camera automatically adjusts shutter speed and aperture for optimal exposure in most situations. This mode is recommended for snapshots and other situations in which you want to leave the camera in charge of shutter speed and aperture. To take photographs in programmed auto:


1 Rotate the mode dial to P.

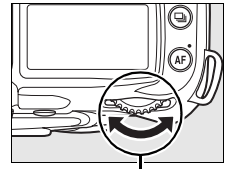
Mode dial



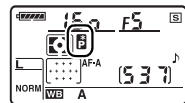
2 Frame a photograph, focus, and shoot.

Flexible Program

In mode **P**, different combinations of shutter speed and aperture can be selected by rotating the main command dial (“flexible program”). Rotate the main command dial to the right for large apertures (small f-numbers) that blur background details or fast shutter speeds that “freeze” motion. Rotate the main command dial to the left for small apertures (large f-numbers) that increase depth of field or slow shutter speeds that blur motion. All combinations produce the same exposure. While flexible program is in effect, a  indicator appears in the control panel. To restore default shutter speed and aperture settings, rotate the main command dial until the indicator is no longer displayed, choose another mode, or turn the camera off.



Main command dial



See Also

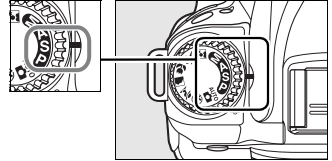
See page 263 for information on the built-in exposure program.

Mode S (Shutter-Priority Auto)

In shutter-priority auto, you choose the shutter speed while the camera automatically selects the aperture that will produce the optimal exposure. Use slow shutter speeds to suggest motion by blurring moving subjects, high shutter speeds to “freeze” motion. To take photographs in shutter-priority auto:

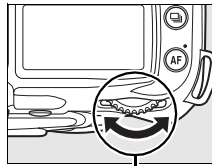
1 Rotate the mode dial to S.

Mode dial

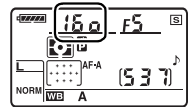


2 Choose a shutter speed.

Press the shutter-release button halfway to activate the exposure meters and rotate the main command dial to choose the desired shutter speed from values between 30 s and $\frac{1}{4,000}$ s.



Main command dial



3 Frame a photograph, focus, and shoot.

See Also

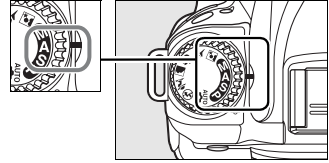
See page 255 for information on what to do if flashing “b u l b” or “- -” indicators appear in the shutter-speed displays.

Mode A (Aperture-Priority Auto)

In aperture-priority auto, you choose the aperture to control depth of field (see below) while the camera automatically selects the shutter speed that will produce the optimal exposure. To take photographs in aperture-priority auto:

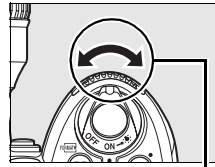
1 Rotate the mode dial to A.

Mode dial

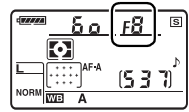


2 Choose an aperture.

Press the shutter-release button halfway to activate the exposure meters and rotate the sub-command dial to choose the desired aperture from values between the minimum and maximum for the lens.



Sub command dial

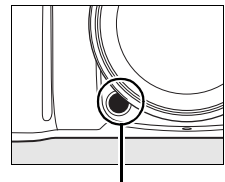


3 Frame a photograph, focus, and shoot.

Depth of Field

"Depth of field" is the distance to which objects behind and in front of the focus point appear to be in focus. Large apertures (low f-numbers) reduce depth of field, blurring objects behind and in front of the main subject. Small apertures (high f-numbers) increase depth of field, bringing out details in the background and foreground (note that depth of field is also influenced by other factors, such as focal length and focus distance). Short field depths are generally used in portraits to blur background details, long field depths in landscape photographs to bring the foreground and background into focus.

To preview depth of field, press and hold the depth-of-field preview button. The lens will be stopped down to the current aperture value, allowing depth of field to be previewed in the viewfinder.



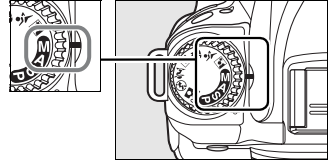
Depth-of-field preview button

Mode M (Manual)

In manual exposure mode, you control both shutter speed and aperture. To take photographs in manual exposure mode:

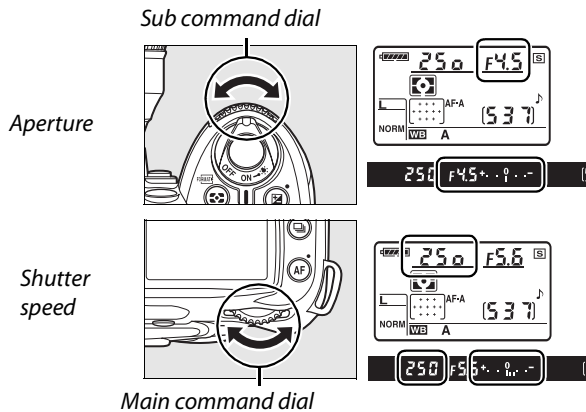
1 Rotate the mode dial to M.

Mode dial



2 Choose aperture and shutter speed.

Checking exposure in the electronic analog exposure display (pg. 84), rotate the main command dial to choose a shutter speed and the sub-command dial to choose an aperture. Shutter speed can be set to values between 30 s and $\frac{1}{4,000}$ s, or the shutter can be held open indefinitely for a long time-exposure (bulb or - -, pg. 85). Aperture can be set to values between the minimum and maximum for the lens.



3 Frame a photograph, focus, and shoot.







The Electronic Analog Exposure Display

If a CPU lens is attached and a shutter speed other than $\frac{1}{2}$ or $\frac{1}{4}$ is selected, the electronic analog exposure display in the viewfinder shows whether the photograph would be under- or over-exposed at current settings. Depending on the option chosen for Custom Setting b1 (**EV steps for exposure cntrl.**; pg. 177), the amount of under- or over-exposure is shown in increments of $\frac{1}{3}$ EV, $\frac{1}{2}$ EV, or 1 EV. If the limits of the exposure metering system are exceeded, the display will flash.

Custom Setting b1 set to 1/3 step		
Optimal exposure	Underexposed by $\frac{1}{3}$ EV	Overexposed by over 2 EV
+ . . 0 . . -	+ . . 0 . . -	+ . . 0 . . -

See Also

If   (+0-) (the default setting) is selected for Custom Setting f7 (**Reverse indicators**, pg. 201), the exposure indicators in the viewfinder and shooting information display are displayed with positive values on the left and negative values on the right. Select   (-0+) to display negative values on the left and positive values on the right.

■ ■ Long Time-Exposures (M Mode Only)

Shutter speeds of “**b u l b**” and “- -” can be used for long time-exposure photographs of moving lights, the stars, night scenery, or fireworks. To prevent blurring caused by camera shake, use a tripod and an optional remote control (pg. 241) or remote cord (pg. 241).

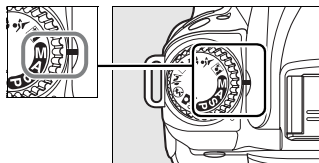
Shutter speed	Description
b u l b	Shutter remains open while shutter-release button is held down. Tripod and optional remote cord are recommended to prevent blur.
- -	Optional ML-L3 remote control required (pg. 241). Select mode M , set shutter speed to “ b u l b ,” and select delayed remote or quick-response remote mode (pg. 68). Shutter opens when shutter-release button on remote control is pressed and remains open for thirty minutes or until shutter-release button is pressed a second time.

1 Ready the camera.

Mount the camera on a tripod or place it on a stable, level surface. To prevent loss of power before the exposure is complete, use a fully charged battery or an optional AC adapter. Note that noise may be present in long exposures; before shooting, choose **On** for the **Long exp. NR** option in the shooting menu (pg. 165). If you are using an optional remote cord, attach it to the camera.

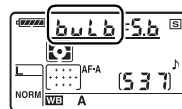
2 Rotate the mode dial to M.

Mode dial



3 Choose a shutter speed.

Press the shutter-release button halfway to activate the exposure meters and rotate the main command dial until “**b u l b**” appears in the shutter-speed displays. For a shutter speed of “- -”, select delayed remote or quick-response remote mode after choosing the shutter speed (pg. 64).



4 Open the shutter.

☞ ☞ ☞: After focusing, press the shutter-release button on the camera or remote cord all the way down. Keep the shutter-release button pressed until the exposure is complete.

- -: Press the shutter-release button on the remote control all the way down. The shutter will open immediately (quick-response remote) or two seconds after the shutter-release button is pressed (delayed remote) and remain open until the button is pressed a second time.

5 Close the shutter.

☞ ☞ ☞: Take your finger off the shutter-release button.

- -: Press the shutter-release button on the remote control all the way down. Shooting ends automatically after thirty minutes.







*Length of exposure: 35 s
Aperture: f/25*

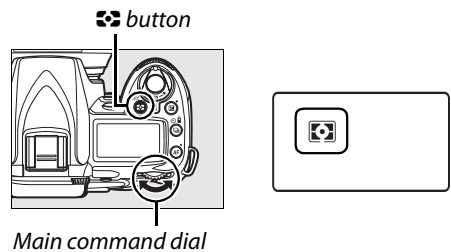
Exposure

Metering

The metering method determines how the camera sets exposure. The following options are available:

Method	Description
 3D color matrix II	Recommended in most situations; selected automatically in auto and scene modes. Camera meters a wide area of the frame and sets exposure according to distribution of brightness, color, distance, and composition for natural results.
 Center-weighted	Camera meters entire frame but assigns greatest weight to center area (defaults to 8-mm circle in center of frame; can be selected using Custom Setting b3, Center-weighted area , pg. 178). Classic meter for portraits; recommended when using filters with an exposure factor (filter factor) over 1× (pg. 240).
 Spot	Camera meters circle 3.5mm (0.14in.) in diameter (approximately 2.5% of frame). Circle is centered on current focus point, making it possible to meter off-center subjects (if non-CPU lens is used, or if Auto-area is selected for AF-area mode as described on page 173, camera will meter center focus point). Ensures that subject will be correctly exposed, even when background is much brighter or darker.

To choose a metering method, press the  button and rotate the main command dial until the desired mode is displayed.



3D Color Matrix II Metering

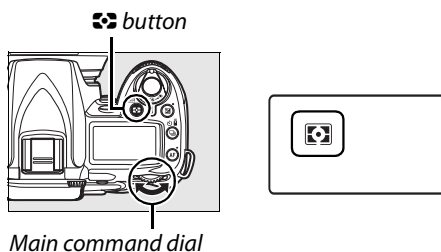
In matrix metering, exposure is set using a 420-segment RGB sensor. Use a type G or D lens for results that include range information (3D color matrix metering II; pg. 228). With other CPU lenses, 3D range information is not included (color matrix metering II).

Autoexposure Lock (P, S, and A Modes Only)

Use auto exposure lock to recompose photographs after metering exposure:

1 Select center-weighted or spot metering.

Select mode **P**, **S**, or **A** and choose center-weighted or spot metering (exposure lock has no effect in mode **M**, while auto and scene modes are not recommended as center-weighted and spot metering are not available).

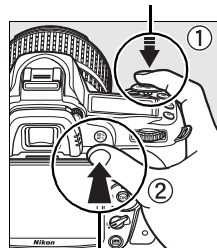


Main command dial

2 Lock exposure.

Position the subject in the selected focus point and press the shutter-release button halfway. With the shutter-release button pressed halfway and the subject positioned in the focus point, press the **AE-L/AF-L** button to lock focus and exposure.

Shutter-release button



AE-L/AF-L button

While exposure lock is in effect, an **AE-L** indicator will appear in the viewfinder.



3 Recompose the photograph.

Keeping the **AE-L/AF-L** button pressed, recompose the photograph and shoot.

Adjusting Shutter Speed and Aperture

While exposure lock is in effect, the following settings can be adjusted without altering the metered value for exposure:

Mode	Setting
Programmed auto	Shutter speed and aperture (flexible program; pg. 80)
Shutter-priority auto	Shutter speed
Aperture-priority auto	Aperture

The new values can be confirmed in the viewfinder and control panel. Note that the metering method can not be changed while exposure lock is in effect (changes to metering take effect when the lock is released).

See Also


If **On** is selected for Custom Setting c1 (**Shutter-release button AE-L**, pg. 179), exposure will lock when the shutter-release button is pressed halfway. For information on changing the role of the **AE-L/AF-L** button, see Custom Setting f4 (**Assign AE-L/AF-L button**, pg. 200).

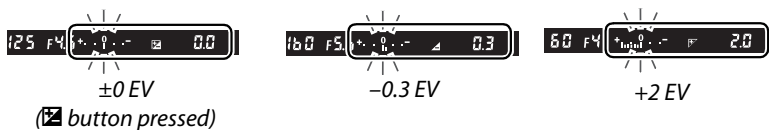
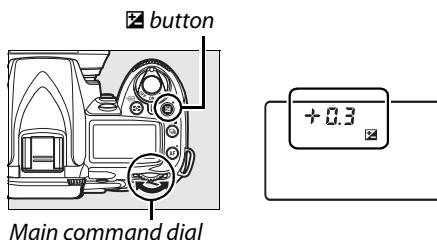





Exposure Compensation

Exposure compensation is used to alter exposure from the value suggested by the camera, making pictures brighter or darker. It is most effective when used with center-weighted or spot metering (pg. 87).

Exposure compensation is available in modes **P**, **S**, and **A** (in mode **M**, only the exposure information shown in the electronic analog exposure display is affected; shutter speed and aperture do not change).

Press the  button and rotate the main command dial until the desired value is displayed in the control panel. Exposure compensation can be set to values between -5 EV (underexposure) and $+5$ EV (overexposure) in increments of $1/3$ EV. In general, choose positive values to make the subject brighter, negative values to make it darker.




At values other than ± 0 , a  icon will be displayed in the control panel and viewfinder after you release the  button. The current value for exposure compensation will be displayed when the  button is pressed.




Normal exposure can be restored by setting exposure compensation to ± 0 . Exposure compensation is not reset when the camera is turned off.

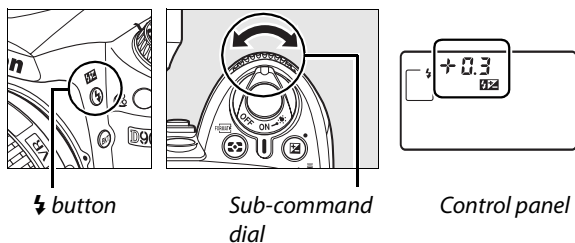
See Also




For information on choosing the size of the increments available for exposure compensation, see Custom Setting b1 (**EV steps for exposure ctrl.**, pg. 177). For information on making adjustments to exposure compensation without pressing the  button, see Custom Setting b2 (**Easy exposure compensation**, pg. 177).

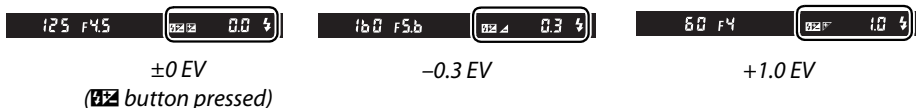
Flash Compensation

Flash compensation is used to alter flash output from the level suggested by the camera, changing the brightness of the main subject relative to the background. Flash output can be increased to make the main subject appear brighter, or reduced to prevent unwanted highlights or reflections.

Press the  button and rotate the sub-command dial until the desired value is displayed in the control panel. Flash compensation can be set to values between -3 EV (darker) and $+1$ EV (brighter) in increments of $1/3$ EV. In general, choose positive values to make the subject brighter, negative values to make it darker.



At values other than ± 0 , a  icon will be displayed in the control panel and viewfinder after you release the  button. The current value for flash compensation will be displayed when the  button is pressed.



Normal flash output can be restored by setting flash compensation to ± 0.0 . Flash exposure compensation is not reset when the camera is turned off.

Optional Flash Units

Flash exposure compensation is also available with an optional SB-900, SB-800, SB-600, SB-400, or SB-R200 flash units.

See Also

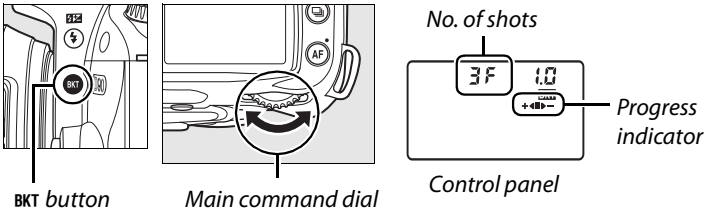
For information on choosing the size of the increments available when setting flash compensation, see Custom Setting b1 (**EV steps for exposure cntrl.**, pg. 177).

Exposure and Flash Bracketing

Bracketing automatically varies selected settings slightly with each shot, “bracketing” the current value. The setting affected is chosen with Custom Setting e4 (**Auto bracketing set**; pg. 191); below, it is assumed that **AE & flash** is selected to vary exposure and flash level. Other options can be used to vary exposure or flash level separately or to bracket white balance or Active D-Lighting.

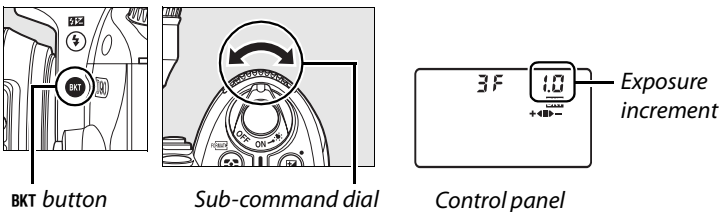
1 Choose the number of shots.

Press the **BKT** button and rotate the main command dial to choose the number of shots in the bracketing sequence (two or three).



2 Select an exposure increment.

Press the **BKT** button and rotate the sub-command dial to choose the exposure increment from values between 0.3 EV and 2.0 EV.

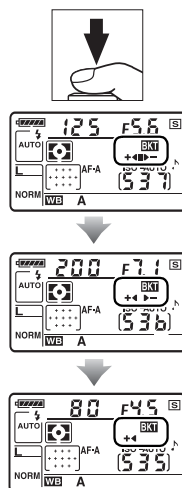


Understanding the Bracketing Display

Number of shots	Progress indicator	Description
3F	+◀▶-	3 shots: unmodified, negative, positive
+2F	+◀■	2 shots: unmodified, positive
--2F	■▶-	2 shots: unmodified, negative

3 Frame a photograph, focus, and shoot.

The camera will vary exposure and flash level with each shot. At default settings, the first shot will be taken at the current values for exposure and flash compensation and the following shots at modified values. If the bracketing sequence consists of three shots, the bracketing increment will be subtracted from the current values in the second shot and added in the third shot, “bracketing” the current values. The modified values can be higher or lower than the maximum and minimum values for exposure and flash compensation. The modified shutter speed and aperture are displayed in the control panel and viewfinder.



While bracketing is in effect, a bracketing progress indicator will be displayed in the control panel. The ■ segment will disappear from the indicator when the unmodified shot is taken, the ►- indicator when the shot with the negative increment is taken, and the +◀ indicator when the shot with the positive increment is taken.



Exposure increment:0 EV



Exposure increment:-1 EV



Exposure increment:+1 EV



To cancel bracketing, press the **BKT** button and rotate the main command dial until the number of shots in the bracketing sequence is zero and **BKT** is no longer displayed in the control panel. The program last in effect will be restored the next time bracketing is activated.



See Also

See page 264 for a list of bracketing programs. For information on choosing the size of the exposure increment, see Custom Setting b1 (**EV steps for exposure ctrl.**, pg. 177). For information on choosing the order in which bracketing is performed, see Custom Setting e6 (**Bracketing order**, pg. 195).

Exposure Bracketing

The camera modifies exposure by varying shutter speed and aperture (programmed auto), aperture (shutter-priority auto), or shutter speed (aperture-priority auto, manual exposure mode). When **On** is selected for **ISO sensitivity auto control** (pg. 166), the camera will automatically vary ISO sensitivity for optimum exposure when the limits of the camera exposure system are exceeded. In exposure bracketing, shutter speed will only be changed after the camera has adjusted ISO sensitivity.

Exposure and Flash Bracketing








In  and  modes, shooting will pause after the number of shots specified in the bracketing program. Selecting auto or scene modes will cancel bracketing; bracketing will resume when mode **P, S, A, or M** is selected. Exposure and flash bracketing are cancelled when **WB bracketing** or **ADL bracketing** is selected for Custom Setting e4 (**Auto bracketing set**; pg. 191).

Resuming Exposure or Flash Bracketing

If the memory card fills before all shots in the sequence have been taken, shooting can be resumed from the next shot in the sequence after the memory card has been replaced or shots have been deleted to make room on the memory card. If the camera is turned off before all shots in the sequence have been taken, bracketing will resume from the next shot in the sequence when the camera is turned on.

White Balance

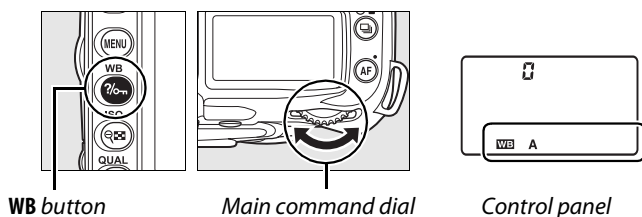
White balance ensures that colors are unaffected by the color of the light source. Auto white balance is recommended for most light sources; if necessary, other values can be selected according to the type of source. The following options are available in **P**, **S**, **A**, and **M** modes (auto white balance is used in auto and scene modes):

Option	Color temp. (K)	Description
A Auto (default)	3,500–8,000*	Camera sets white balance automatically; recommended in most situations. For best results, use type G or D lens. If built-in or optional flash is used, white balance reflects conditions in effect when flash fires.
 Incandescent	3,000*	Use under incandescent lighting.
 Fluorescent		Use with the following seven light sources:
Sodium-vapor lamps	2,700*	Use under sodium-vapor lighting (found in sports venues).
Warm-white fluorescent	3,000*	Use under warm-white fluorescent lights.
White fluorescent	3,700*	Use under white fluorescent lights.
Cool-white fluorescent (default for Fluorescent)	4,200*	Use under cool-white fluorescent lights.
Day white fluorescent	5,000*	Use under daylight white fluorescent lights.
Daylight fluorescent	6,500*	Use under daylight fluorescent lights.
High temp. mercury-vapor	7,200*	Use under high color temperature light sources (e.g. mercury-vapor lamps).
 Direct sunlight	5,200*	Use with subjects lit by direct sunlight.
 Flash	5,400*	Use with built-in or optional flash.
 Cloudy	6,000*	Use in daylight under overcast skies.
 Shade	8,000*	Use in daylight with subjects in the shade.
 Choose color temp.	2,500–10,000	Choose color temperature from list of values (pg. 99).
PRE Preset manual	—	Use subject, light source, or existing photograph as reference for white balance (pg. 100).

* All values are approximate. Fine-tuning set to 0.



To select a value for white balance, press the **WB** button and rotate the main command dial until the desired setting is displayed in the control panel. White balance can also be adjusted from the shooting menu (pg. 165).



☀ (Fluorescent)

The bulb type is chosen using the **White balance** option in the shooting menu (pg.165).

See Also

When **WB bracketing** is selected for Custom Setting e4 (**Auto bracketing set**, pg. 191), the camera will create several images each time the shutter is released. White balance will be varied with each image, "bracketing" the value currently selected for white balance. See page 191 for more information.

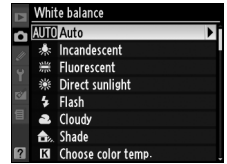
Fine-Tuning White Balance

White balance can be “fine tuned” to compensate for variations in the color of the light source or to introduce a deliberate color cast into an image. White balance is fine tuned using the **White balance** option in the shooting menu or by pressing the **WB** button and rotating the sub-command dial.

■ The White Balance Menu

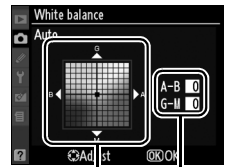
1 Select a white balance option.

Select **White balance** in the shooting menu (pg. 165), then highlight a white balance option and press **▶**. If an option other than **Fluorescent**, **Choose color temp.**, or **Preset manual** is selected, proceed to Step 2. If **Fluorescent** is selected, highlight a lighting type and press **▶**. If **Choose color temp.** is selected, highlight a color temperature and press **▶**. If **Preset manual** is selected, choose a preset as described on page 106 before proceeding.



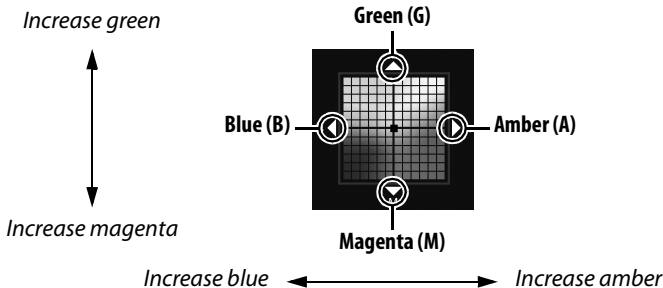
2 Fine tune white balance.

Use the multi selector to fine-tune white balance. White balance can be fine tuned on the amber (A)–blue (B) axis and the green (G)–magenta (M) axis. The horizontal (amber–blue) axis corresponds to color temperature, with each increment equivalent to about 5 mired. The vertical (green–magenta) axis has the similar effects to the corresponding color compensation (CC) filters.




Coordinates

Adjustment

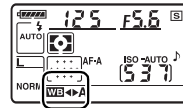


🔍 White Balance Fine Tuning

The colors on the fine-tuning axes are relative, not absolute. For example, moving the cursor to **B** (blue) when a “warm” setting such as  (incandescent) is selected for white balance will make photographs slightly “colder” but will not actually make them blue.

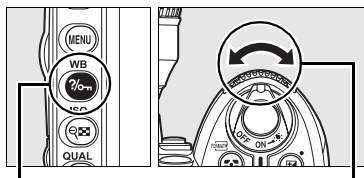
3 Press **OK**.

Press **OK** to save settings and return to the shooting menu. If white balance has been fine-tuned on the A-B axis, a **◀▶** icon will be displayed in the control panel.



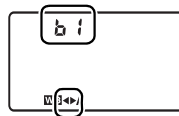
■ The WB Button

At settings other than **☑** (**Choose color temp.**) and **PRE** (**Preset manual**), the **WB** button can be used to fine-tune white balance on the amber (A)–blue (B) axis (pg. 97; to fine-tune white balance when **☑** or **PRE** is selected, use the shooting menu as described on page 97). Six settings in both directions are available; each increment is equivalent to about 5 mired (see below). Press the **WB** button and rotate the sub-command dial until the desired value is displayed in the control panel. Rotating the sub-command dial to the left increases the amount of amber (A). Rotating the sub-command dial to the right increases the amount of blue (B). At settings other than 0, a **◀▶** icon appears in the control panel.



WB button

Sub-command dial



Control panel

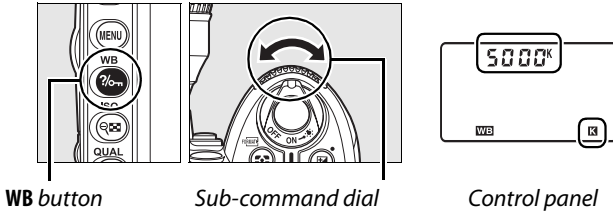
✍ "Mired"

Any given change in color temperature produces a greater difference in color at low color temperatures than it would at higher color temperatures. For example, a change of 1000 K produces a much greater change in color at 3000 K than at 6000 K. Mired, calculated by multiplying the inverse of the color temperature by 10^6 , is a measure of color temperature that takes such variation into account, and as such is the unit used in color-temperature compensation filters. E.g.:

- 4000 K–3000 K (a difference of 1000 K)=83 mired
- 7000 K–6000 K (a difference of 1000 K)=24 mired

Choosing a Color Temperature

At a setting of **☑ (Choose color temp.)**, color temperature can be selected by pressing the **WB** button and rotating the sub-command dial until the desired value is displayed in the control panel. Color temperature can also be selected in the shooting menu (pg. 165).



☑ Color Temperature

The perceived color of a light source varies with the viewer and other conditions. Color temperature is an objective measure of the color of a light source, defined with reference to the temperature to which an object would have to be heated to radiate light in the same wavelengths. While light sources with a color temperature in the neighborhood of 5,000–5,500 K appear white, light sources with a lower color temperature, such as incandescent light bulbs, appear slightly yellow or red. Light sources with a higher color temperature appear tinged with blue.

☑ Choose Color Temperature

Note that the desired results will not be obtained with flash or fluorescent lighting. Choose **⚡ (Flash)** or **☀ (Fluorescent)** for these sources. With other light sources, take a test shot to determine if the selected value is appropriate.

☑ The White Balance Menu

Color temperature can also be selected in the white balance menu. Note that the color temperature with the **WB** button and the sub-command dial replaces the value selected in the white balance menu.



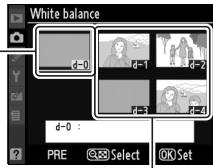
Preset Manual

Preset manual is used to record and recall custom white balance settings for shooting under mixed lighting or to compensate for light sources with a strong color cast. Two methods are available for setting preset white balance:

Method	Description
Direct measurement	Neutral gray or white object is placed under lighting that will be used in final photograph and white balance is measured by camera (pg. 101).
Copy from existing photograph	White balance is copied from photo on memory card (pg. 105).

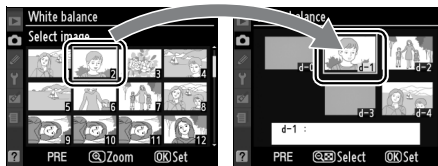
The camera can store up to five values for preset white balance in presets d-0 through d-4. A descriptive comment can be added to any white balance preset (pg. 107).

d-0: Stores last value measured for white balance (pg. 101). This preset is overwritten when a new value is measured.



d-1–d-4: Store values copied from d-0 (pg. 104).

Store values copied from images on memory card (pg. 105).



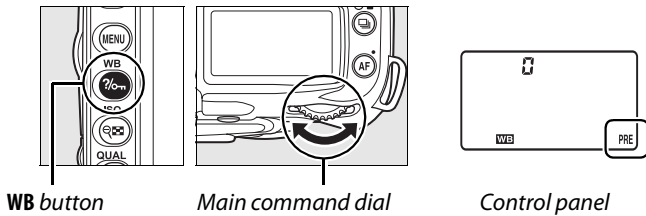
■ ■ Measuring a Value for Preset White Balance

1 Light a reference object.

Place a neutral gray or white object under the lighting that will be used in the final photograph. In studio settings, a standard gray panel can be used as a reference object. Note that exposure is automatically increased by 1 EV when measuring white balance; in exposure mode **M**, adjust exposure so that the electronic analog exposure displays shows ± 0 (pg. 84).

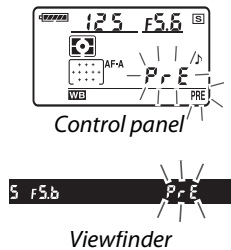
2 Set white balance to PRE (Preset manual).

Press the **WB** button and rotate the main command dial until **PRE** is displayed in the control panel.



3 Select direct measurement mode.

Release the **WB** button briefly and then press the button until the **PRE** icon in the control panel starts to flash. A flashing **PrE** will also appear in the control panel and viewfinder. At default settings, the displays will flash for about six seconds. To exit without measuring a value for preset white balance, press the **WB** button again.



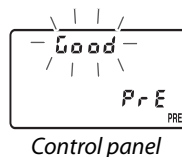
4 Measure white balance.

Before the indicators stop flashing, frame the reference object so that it fills the viewfinder and press the shutter-release button all the way down. The camera will measure a value for white balance and store it in preset d-0. No photograph will be recorded; white balance can be measured accurately even when the camera is not in focus.

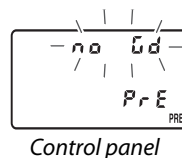


5 Check the results.

If the camera was able to measure a value for white balance, **Good** will flash in the control panel, while the viewfinder will show a flashing **Wd**. At default settings, the displays will flash for about six seconds.



If lighting is too dark or too bright, the camera may be unable to measure white balance. A flashing **no Wd** will appear in the control panel and viewfinder (at default settings, the displays will flash for about six seconds). Press the shutter-release button halfway to return to Step 4 and measure white balance again.



6 Select preset d-0.

If the new value for preset white balance will be used immediately, select preset d-0 by pressing the **WB** button and rotating the sub-command dial until d-0 is displayed in the control panel.

Direct Measurement Mode

If no operations are performed while the displays are flashing, direct measurement mode will end in the time selected for Custom Setting c2 (**Auto meter-off delay**, pg. 179). The default setting is six seconds.

Preset d-0

The new value for white balance will be stored in preset d-0, automatically replacing the previous value for this preset (no confirmation dialog will be displayed). A thumbnail will be displayed in the preset white balance list.



To use the new value for white balance, select preset d-0 (if no value has been measured for white balance before d-0 is selected, white balance will be set to a color temperature of 5,200 K, the same as **Direct sunlight**). The new white balance value will remain in preset d-0 until white balance is measured again. By copying preset d-0 to one of the other presets before measuring a new value for white balance, up to five white balance values can be stored (pg. 104).

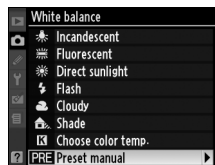


■ Copying White Balance from d-0 to Presets d-1–d-4


Follow the steps below to copy a measured value for white balance from d-0 to any of the other presets (d-1–d-4).

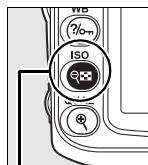
1 Select PRE (Preset manual).


Highlight **Preset manual** in the white balance menu (pg. 95) and press ►.

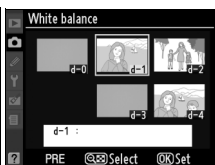


2 Select a destination.


Highlight the destination preset (d-1 to d-4) and press the  button.

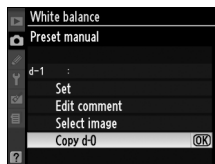


 button



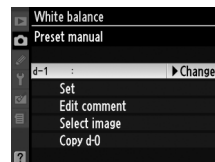
3 Copy d-0 to the selected preset.

Highlight **Copy d-0** and press . If a comment has been created for d-0 (pg. 107), the comment will be copied to the comment for the selected preset.



Choosing a White Balance Preset

To select another white balance preset in the **Preset manual** menu (see Step 3, above), press ▲ to highlight the current white balance preset (d-0–d-4) and press ►.

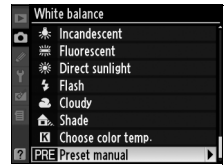


■ Copying White Balance from a Photograph (d-1–d-4 Only)


Follow the steps below to copy a value for white balance from a photograph on the memory card to a selected preset (d-1–d-4 only). Existing white balance values can not be copied to preset d-0.

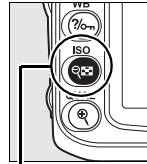
1 Select PRE (Preset manual).


Highlight **Preset manual** in the white balance menu (pg. 95) and press ►.

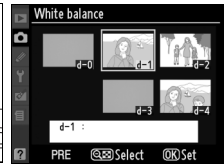


2 Select a destination.

Highlight the destination preset (d-1 to d-4) and press the  button.

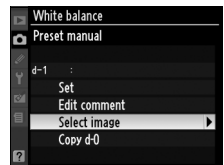


 button




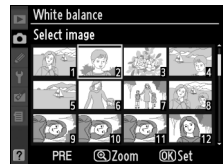
3 Choose Select image.

Highlight **Select image** and press ►.




4 Highlight a source image.

Highlight the source image. To view the highlighted image full frame, press the  button.



5 Copy white balance.

Press  to copy the white balance value for the highlighted photograph to the selected preset. If the highlighted photograph has a comment (pg. 205), the comment will be copied to the comment for the selected preset.

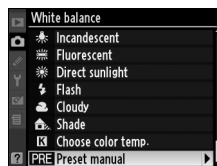


■ Selecting a White Balance Preset




To set white balance to a preset value:

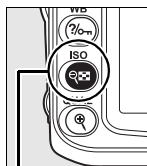
1 Select PRE (Preset manual).

Highlight **Preset manual** in the white balance menu (pg. 95) and press ►.



2 Select a preset.

Highlight the desired preset and press the  button. To select the highlighted preset and display the fine tuning menu (pg. 97) without completing the next step, press  instead of pressing the  button.



 button



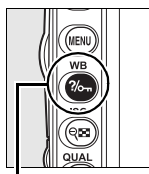
3 Select Set.

Highlight **Set** and press ►. Fine tuning menu for the selected white balance preset is displayed (pg. 98).

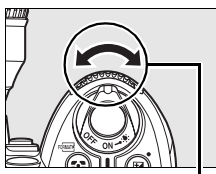


■ Selecting a White Balance Preset: the WB Button

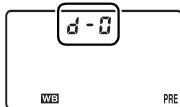
At a setting of **PRE (Preset manual)**, presets can also be selected by pressing the **WB** button and rotating the sub-command dial. The current preset is displayed in the control panel while the **WB** button is pressed.



WB button



Sub-command dial



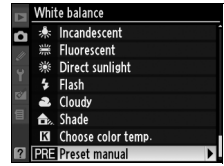
Control panel

■ Entering a Comment


Follow the steps below to enter a descriptive comment of up to thirty-six characters for a selected white balance preset.

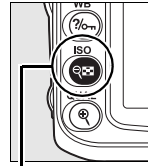
1 Select PRE (Preset manual).


Highlight **Preset manual** in the white balance menu (pg. 95) and press ►.



2 Select a preset.

Highlight the desired preset and press the  button.

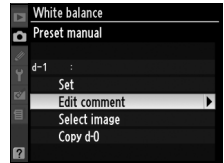


 button



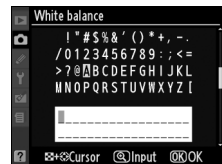
3 Select Edit comment.

Highlight **Edit comment** and press ►.



4 Edit the comment.

Edit the comment as described on page 169.



Picture Controls

Nikon's unique Picture Control system makes it possible to share image processing settings among compatible devices and software. Select from the Picture Controls provided with the camera to instantly adjust image processing settings, or make independent adjustments to sharpening, contrast, brightness, saturation, and hue. These settings can be saved under new names as custom Picture Controls to be recalled or edited at will. Custom Picture Controls can also be saved to the memory card for use in compatible software, and software-created Picture Controls can be loaded into the camera. Any given set of Picture Controls will produce nearly the same results on all cameras that support the Nikon Picture Control system.

■ ■ Using Picture Controls

Picture Controls can be used as described below.

- **Select Nikon Picture Controls** (pg. 109): Select an existing Nikon Picture Control.
- **Modify existing Picture Controls** (pg. 110): Modify an existing Picture Control to create a combination of sharpening, contrast, brightness, saturation, and hue for a particular scene or effect.
- **Create custom Picture Controls** (pg. 113): Store modified Picture Controls under unique names and recall or edit them as desired.
- **Share custom Picture Controls** (pg. 115): Custom Picture Controls created with the camera can be saved to the memory card for use in ViewNX (supplied) and other compatible software, or software-created custom Picture Controls can be loaded into the camera.
- **Manage custom Picture Controls** (pg. 117): Rename or delete custom Picture Controls.

✍ Nikon Picture Controls Versus Custom Picture Controls

The Picture Controls supplied by Nikon are referred to as *Nikon Picture Controls*. In addition to the Nikon Picture Controls supplied with the camera, *optional Picture Controls* are available for download from Nikon websites. *Custom Picture Controls* are created through modifications to existing Nikon Picture Controls. Both Nikon and custom Picture Controls can be shared among compatible devices and software.

Selecting Nikon Picture Controls

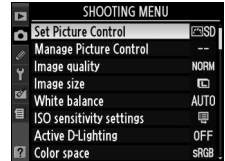
The camera offers six preset Nikon Picture Controls. Choose a Picture Control according to the subject or type of scene.

Option	Description
Standard	Standard processing for balanced results. Recommended for most situations.
Neutral	Minimal processing for natural results. Choose for photographs that will later be extensively processed or retouched.
Vivid	Pictures are enhanced for a vivid, photoprint effect. Choose for photographs that emphasize primary colors.
Monochrome	Take monochrome photographs.
Portrait	Lends a natural texture and rounded feel to the skin of portrait subjects.
Landscape	Produces vibrant landscapes and cityscapes.

Choosing a Picture Control

1 Select Set Picture Control.

In the shooting menu (pg. 165), highlight **Set Picture Control** and press .



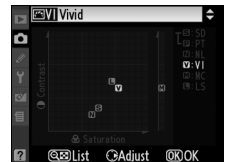
2 Select a Picture Control.

Highlight the desired Picture Control and press .



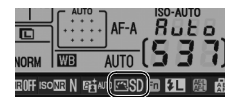
The Picture Control Grid

Pressing the button in Step 2 displays a Picture Control grid showing the contrast and saturation for the selected Picture Control in relation to the other Picture Controls (only contrast is displayed when **Monochrome** is selected). To select a different Picture Control, press or , then press to display Picture Control options and press .



The Picture Control Indicator

The current Picture Control is shown in the shooting information display when the button is pressed. Picture Controls can also be selected in the shooting information display (pg. 12).



Picture Control indicator

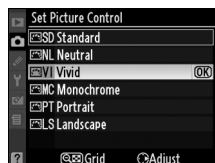
Modifying Existing Picture Controls

Existing Nikon or custom Picture Controls can be modified to suit the scene or the user's creative intent. Choose a balanced combination of settings using **Quick adjust**, or make manual adjustments to individual settings.




1 Select a Picture Control.

Highlight the desired Picture Control in the **Set Picture Control** menu (pg. 109) and press ►.



2 Adjust settings.

Press ▲ or ▼ to highlight the desired setting and press ◀ or ▶ to choose a value (pg. 111). Repeat this step until all settings have been adjusted, or select **Quick adjust** to choose a preset combination of settings. Default settings can be restored by pressing the  button.



3 Press OK.



Modifications to Original Picture Controls

Picture Controls that have been modified from default settings are indicated by an asterisk (*) in the **Set Picture Control** menu.

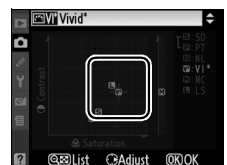


Picture Control Settings



Option	Description	
Quick adjust	Choose from options between -2 and +2 to reduce or exaggerate the effect of the selected Picture Control (note that this resets all manual adjustments). For example, choosing positive values for Vivid makes pictures more vivid. Not available with Neutral , Monochrome , or custom Picture Controls.	
Manual adjustments (all Picture Controls)	Sharpening	Control the sharpness of outlines. Select A to adjust sharpening automatically according to the type of scene, or choose from values between 0 (no sharpening) and 9 (the higher the value, the greater the sharpening).
	Contrast	Select A to adjust contrast automatically according to the type of scene, or choose from values between -3 and +3 (choose lower values to prevent highlights in portrait subjects from being “washed out” in direct sunlight, higher values to preserve detail in misty landscapes and other low-contrast subjects). Not available when Active D-Lighting (pg. 119) is on; reset if Active D-Lighting is activated after value is changed.
	Brightness	Choose -1 for reduced brightness, +1 for enhanced brightness. Does not affect exposure. Not available when Active D-Lighting (pg. 119) is on; reset if Active D-Lighting is activated after value is changed.
Manual adjustments (non-monochrome only)	Saturation	Control the vividness of colors. Select A to adjust saturation automatically according to the type of scene, or choose from values between -3 and +3 (lower values reduce saturation and higher values increase it).
	Hue	Choose negative values (to a minimum of -3) to make reds more purple, blues more green, and greens more yellow, positive values (up to +3) to make reds more orange, greens more blue, and blues more purple.
Manual adjustments (monochrome only)	Filter effects	Simulate the effect of color filters on monochrome photographs. Choose from Off (the default setting), yellow, orange, red, and green (pg. 112).
	Toning	Choose the tint used in monochrome photographs from B&W (black-and-white, the default setting), Sepia , Cyanotype (blue-tinted monochrome), Red , Yellow , Green , Blue Green , Blue , Purple Blue , Red Purple (pg. 112).

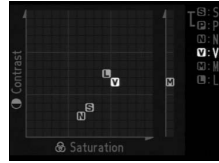
“A” (Auto)

Results for auto contrast and saturation vary with exposure and the position of the subject in the frame. Use a type G or D lens for best results. The icons for Picture Controls that use auto contrast and saturation are displayed in green in the Picture Control grid, and lines appear parallel to the axes of the grid.



The Picture Control Grid

Pressing the  button in Step 2 displays a Picture Control grid showing the contrast and saturation for the selected Picture Control in relation to the other Picture Controls (only contrast is displayed when **Monochrome** is selected). Release the  button to return to the Picture Control menu.



Previous Settings

The line under the value display in the Picture Control setting menu indicates the previous value for the setting. Use this as a reference when adjusting settings.






Filter Effects (Monochrome Only)

The options in this menu simulate the effect of color filters on monochrome photographs. The following filter effects are available:

Option	Description
Y Yellow	Enhances contrast. Can be used to tone down the brightness of the sky in
O Orange	landscape photographs. Orange produces more contrast than yellow, red more
R Red	contrast than orange.
G Green	Softens skin tones. Can be used for portraits.

Note that the effects achieved with **Filter effects** are more pronounced than those produced by physical glass filters.

Toning (Monochrome Only)

Pressing  when **Toning** is selected displays saturation options. Press  or  to adjust saturation. Saturation control is not available when **B&W** (black-and-white) is selected.

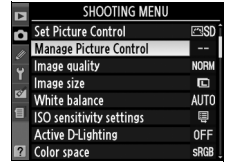


Creating Custom Picture Controls

The Nikon Picture Controls supplied with the camera can be modified and saved as custom Picture Controls.

1 Select Manage Picture Control.

In the shooting menu (pg. 165), highlight **Manage Picture Control** and press ►.



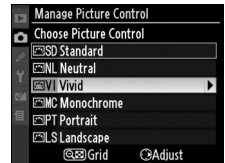
2 Select Save/edit.

Highlight **Save/edit** and press ►.



3 Select a Picture Control.

Highlight an existing Picture Control and press ►, or press **OK** to proceed to step 5 and save a copy of the highlighted Picture Control without further modification.



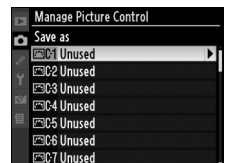
4 Edit the selected Picture Control.

See page 111 for more information. To abandon any changes and start over, press the **Reset** button. Press **OK** when settings are complete.



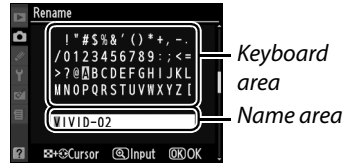
5 Select a destination.

Choose a destination for the custom Picture Control (C-1 through C-9) and press ►.



6 Name the Picture Control.

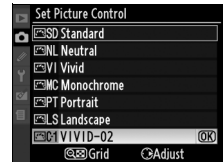
The text-entry dialog shown at right will be displayed. By default, new Picture Controls are named by adding a two-digit number (assigned automatically) to the name of the existing Picture Control. This name can be edited to create a new name as described below.



To move the cursor in the name area, press the button and press or . To enter a new letter at the current cursor position, use the multi selector to highlight the desired character in the keyboard area and press the button. To delete the character at the current cursor position, press the button.

Custom Picture Control names can be up to 19 characters long. Any characters after the 19th will be deleted.

After entering the name, press . The new Picture Control will appear in the Picture Control list.



Custom Picture Controls can be renamed at any time using the **Rename** option in the **Manage Picture Control** menu.



Custom Picture Controls

The edit display for custom Picture Controls contains the same options as the original Nikon Picture Control on which it is based. The original control is shown by an icon in the top right corner of the display.

Original Picture Control icon



Custom Picture Controls

The options available with custom Picture Controls are the same as those on which the custom Picture Control was based.

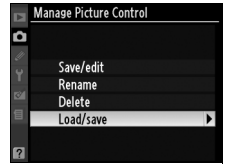
Sharing Custom Picture Controls

Custom Picture Controls created using the Picture Control Utility available with ViewNX or optional software such as Capture NX 2 can be copied to a memory card and loaded into the camera, or custom Picture Controls created with the camera can be copied to the memory card to be used in compatible cameras and software.

■ Copying Custom Picture Controls to the Camera

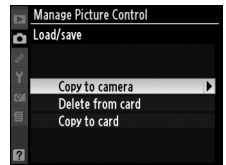
1 Select Load/save.

In the **Manage Picture Control** menu, highlight **Load/save** and press ►.



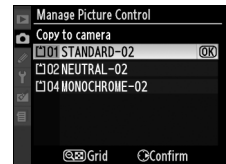
2 Select Copy to camera.

Highlight **Copy to camera** and press ►.



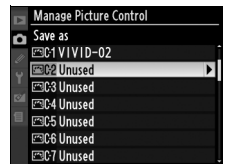
3 Select a Picture Control.

Highlight a custom Picture Control and either press ► to view current Picture Control settings, or press OK to proceed to Step 4.



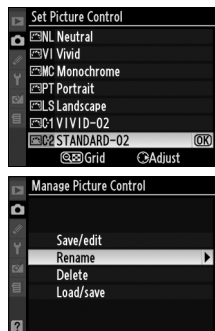
4 Select a destination.

Choose a destination for the custom Picture Control (C-1 through C-9) and press ►.



5 Name the Picture Control.

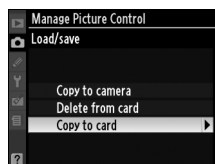
Name the Picture Control as described on page 114. The new Picture Control will appear in the Picture Control list and can be renamed at any time using the **Rename** option in the **Manage Picture Control** menu.



Saving Custom Picture Controls to the Memory Card

1 Select Copy to card.

After displaying the **Load/save** menu as described in Step 1 on page 115, highlight **Copy to card** and press **▶**.



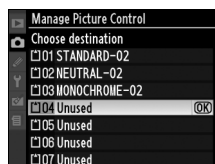
2 Select a Picture Control.

Highlight a custom Picture Control and press **▶**.



3 Choose a destination.

Choose a destination from slots 1 through 99 and press **OK** to save the selected Picture Control to the memory card. Any Picture Controls that may already have been saved to the selected slot will be overwritten.



Saving Custom Picture Controls

Up to 99 custom Picture Controls can be stored on the memory card at any one time. The memory card can only be used to store user-created custom Picture Controls. The Nikon Picture Controls supplied with the camera can not be copied to the memory card.

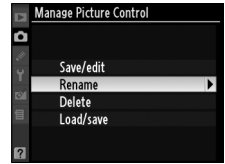
Managing Custom Picture Controls

Follow the steps below to rename or delete custom Picture Controls.

Renaming Custom Picture Controls

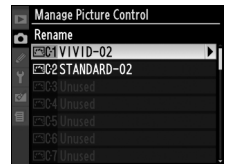
1 Select Rename.

In the **Manage Picture Control** menu, highlight **Rename** and press ►.



2 Select a Picture Control.

Highlight a custom Picture Control (C-1 through C-9) and press ►.



3 Rename the Picture Control.

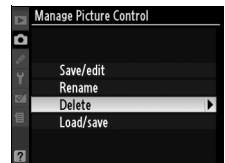
Rename the Picture Control as described on page 114.



Deleting Custom Picture Controls from the Camera

1 Select Delete.

In the **Manage Picture Control** menu, highlight **Delete** and press ►.



2 Select a Picture Control.

Highlight a custom Picture Control (C-1 through C-9) and press ►.



3 Select Yes.

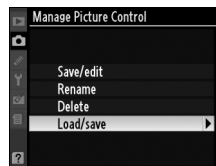
Highlight **Yes** and press **OK** to delete the selected Picture Control.



■ Deleting Custom Picture Controls from the Memory Card

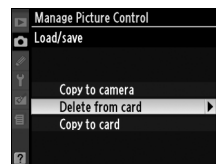
1 Select Load/save.

In the **Manage Picture Control** menu, highlight **Load/save** and press **▶**.



2 Select Delete from card.

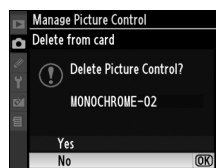
Highlight **Delete from card** and press **▶**.



3 Select a Picture Control.

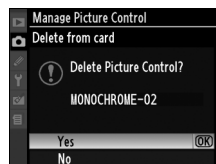
Highlight a custom Picture Control (slot 1 through 99) and either:

- press **▶** to view current Picture Control settings, or
- press **OK** to display confirmation dialog shown at right.



4 Select Yes.

Highlight **Yes** and press **OK** to delete the selected Picture Control.



✍ Nikon Picture Controls

The Nikon Picture Controls supplied with the camera (**Standard**, **Neutral**, **Vivid**, **Monochrome**, **Portrait**, and **Landscape**) can not be renamed or deleted.

Active D-Lighting

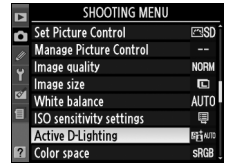
Active D-Lighting preserves details in highlights and shadows, creating photographs with natural contrast. Use for high contrast scenes, for example when photographing brightly lit outdoor scenery through a door or window or taking pictures of shaded subjects on a sunny day. To use Active D-Lighting:

1 Select matrix metering.

Matrix metering (☒, pg. 87) is recommended when using Active D-Lighting.

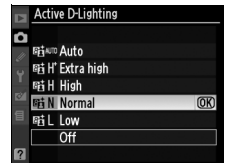
2 Select Active D-Lighting.

In the shooting menu (pg. 165), highlight **Active D-Lighting** and press ►.



3 Choose an option.

Highlight **Auto**, **Extra high**, **High**, **Normal**, **Low**, or **Off** and press OK. Choose **Auto** to let the camera adjust D-Lighting automatically according to shooting conditions.



✓ **Active D-Lighting**

Noise (grains, banding, mottling) may appear in photographs taken with Active D-Lighting at high ISO sensitivities. The **Brightness** and **Contrast** Picture Control settings (pg. 111) can not be adjusted while active D-Lighting is in effect. In exposure mode **M**, an Active D-Lighting setting of **Auto** is equivalent to **Normal**.

✓ **“Active D-Lighting” Versus “D-Lighting”**

The **Active D-Lighting** option in the shooting menu adjusts exposure before shooting to optimize the dynamic range, while the **D-Lighting** option in the retouch menu optimizes dynamic range in images after shooting.

✎ **ADL Bracketing**

When **ADL bracketing** is selected for Custom Setting e4 (**Auto bracketing set**, pg. 191), the camera will automatically vary Active D-Lighting over two photographs: the first will be taken with the current setting for Active-D-Lighting, the second with Active D-Lighting off. See page 193 for more information.



Multiple Exposure

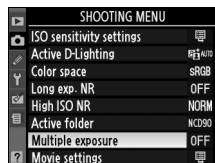
Follow the steps below to record a series of two to three exposures in a single photograph, using RAW data from the camera image sensor to produce colors noticeably superior to photographs combined in an imaging application. Multiple exposures can be recorded at any image quality setting.

■ Creating a Multiple Exposure

Note that at default settings, shooting will end and a multiple exposure will be recorded automatically if no operations are performed for 30 s.

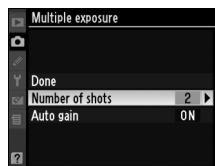
1 Select Multiple exposure.

Highlight **Multiple exposure** in the shooting menu and press ►.



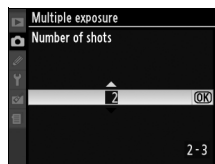
2 Select Number of shots.

Highlight **Number of shots** and press ►.



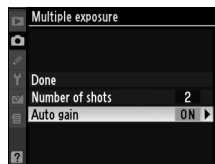
3 Select the number of shots.

Press ▲ or ▼ to choose the number of exposures (two or three) that will be combined to form a single photograph and press OK.



4 Select Auto gain.

Highlight **Auto gain** and press ►.



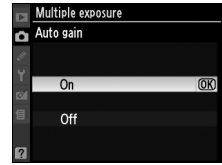
■ Extended Recording Times

For an interval between exposures of more than 30 s, select **On** for the **Image review** (pg. 163) option in the playback menu and extend the monitor-off delay for image review using Custom Setting c4 (**Monitor off delay**, pg. 180). The maximum interval between exposures is 30 s longer than the option selected for Custom Setting c4.


5 Set gain.

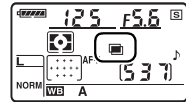
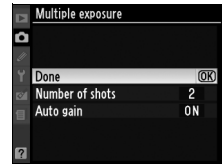
Highlight one of the following options and press **OK**.

Option	Description
On (default)	Gain adjusted according to number of exposures actually recorded (gain for each exposure is set to $\frac{1}{2}$ for 2 exposures, $\frac{1}{3}$ for 3 exposures).
Off	Gain is not adjusted when recording multiple exposure. Recommended if background is dark.





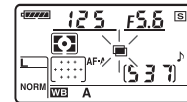
6 Select Done.



Highlight **Done** and press **OK**. A  icon will be displayed in the control panel. To exit without taking a multiple exposure, select **Multiple exposure** > **Reset** in the shooting menu.

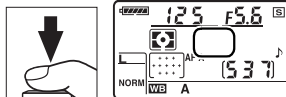


7 Frame a photograph, focus, and shoot.


In  and  release modes (pg. 64), the camera records all exposures in a single burst. In single-frame release mode, one photograph will be taken each time the shutter-release button is pressed; continue shooting until all exposures have been recorded (for information on interrupting a multiple exposure before all photographs are recorded, see page 123).

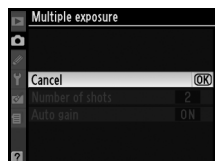


The  icon will blink until shooting ends. When shooting ends, multiple exposure mode will end and the  icon will no longer be displayed. Repeat steps 1–7 to take additional multiple exposures.



■ Interrupting Multiple Exposures

Selecting **Multiple exposure** in the shooting menu while a multiple exposure is being recorded displays the options shown at right. To interrupt a multiple exposure before the specified number of exposures have been taken, highlight **Cancel** and press . If shooting ends before the specified number of exposures has been taken, a multiple exposure will be created from the exposures recorded to that point. If **Auto gain** is on, gain will be adjusted to reflect the number of exposures actually recorded. Note that shooting will end automatically if:



- A two-button reset is performed (pg. 75)
- The camera is turned off
- The battery is exhausted
- Pictures are deleted

✓ Multiple Exposure

Do not remove or replace the memory card while recording a multiple exposure.

Live view (pg. 43) can not be used to record multiple exposures.

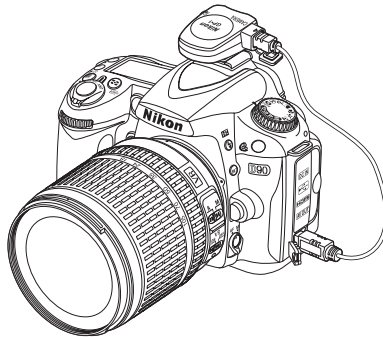
The information listed in the playback photo information display (including date of recording and camera orientation) is for the first shot in the multiple exposure.

✍ Other Settings

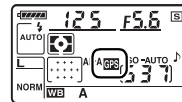
While multiple exposure mode is in effect, memory cards can not be formatted, changes can not be made to bracketing or to shooting menu options other than **White balance**, and the **Lock mirror up for cleaning** and **Image Dust Off ref photo** options in the setup menu can not be used.

The GP-1 GPS Unit

The GP-1 GPS unit (available separately) can be connected to the camera's accessory terminal as shown below using the cable supplied with the GP-1, allowing information on the camera's current position to be recorded when photographs are taken. Turn the camera off before connecting the GP-1; for more information, see the GP-1 manual.

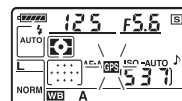


When the camera establishes communication with the GP-1, a **GPS** icon will be displayed in the control panel. Photo information for pictures taken while the **GPS** icon is displayed will include an additional page (pg. 133) recording the current latitude, longitude, altitude, and Coordinated Universal Time (UTC). If no data are received from the GP-1 for two seconds, the **GPS** icon will clear from the display and the camera will stop recording GPS information.



GPS Data

GPS data are only recorded when the **GPS** icon is displayed. Confirm that the **GPS** icon is displayed in the control panel before shooting. A flashing **GPS** icon indicates that the GP-1 is searching for a signal; pictures taken while the **GPS** icon is flashing will not include GPS data.



■ Setup Menu Options

The **GPS** item in the setup menu contains the options listed below.

- **Auto meter off:** Choose whether or not the exposure meters will turn off automatically when the GP-1 is attached.

Option	Description
Enable (default)	Exposure meters will turn off automatically if no operations are performed for the period specified in Custom Setting c2 (Auto meter-off delay , pg. 179). This reduces the drain on the battery but may prevent GPS data from being recorded if the shutter-release button is pressed all the way down without pausing.
Disable	Exposure meters will not turn off while the GP-1 is connected; GPS data will always be recorded.

- **Position:** This item is only available if the GP-1 is connected, when it displays the current latitude, longitude, altitude, and Coordinated Universal Time (UTC) as reported by the GP-1.



Coordinated Universal Time (UTC)

UTC data is provided by the GPS device and is independent of the camera clock.






More on Playback

This chapter describes how to view photographs and details the operations that can be performed during playback.


















Full-Frame Playback	128
Photo Information	129
Thumbnail Playback	135
Calendar Playback	136
Taking a Closer Look: Playback Zoom	138
Protecting Photographs from Deletion	139
Deleting Individual Photographs	140
Pictmotion	141
Slide Shows	143



Full-Frame Playback

To play photographs back, press the  button. The most recent photograph will be displayed in the monitor.



To	Use	Description
View additional photographs		Press  to view photographs in order recorded,  to view photographs in reverse order.
View photo information		Press  or  to view information about current photograph (pg. 129).
View thumbnails		See page 135 for more information on the thumbnail display.
Zoom in on photograph		See page 138 for more information on playback zoom.
Delete images		Confirmation dialog will be displayed. Press  again to delete photo.
Change protect status		To protect image, or to remove protection from protected image, press  button (pg. 139).
Return to shooting mode	 / 	Monitor will turn off. Photographs can be taken immediately.
Display menus	MENU	See page 159 for more information.
Retouch photo or play movie		Create retouched copy of current photograph (pg. 209). If current picture is marked with  icon to show that it is a movie, pressing  starts movie playback (pg. 52).

Rotate Tall

To display “tall” (portrait-orientation) photographs in tall orientation, select **On** for the **Rotate tall** option in the playback menu (pg. 163).

Image Review

When **On** is selected for **Image review** in the playback menu (pg. 163), photographs are automatically displayed in the monitor for about 4 s (the default setting) after shooting.

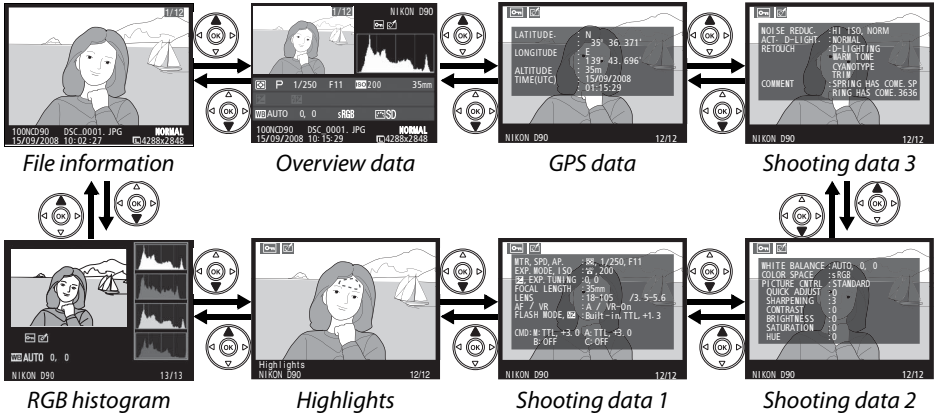
See Also

See Custom Setting c4 (**Monitor off delay**, pg. 180) for information on choosing how long the monitor will remain on when no operations are performed.

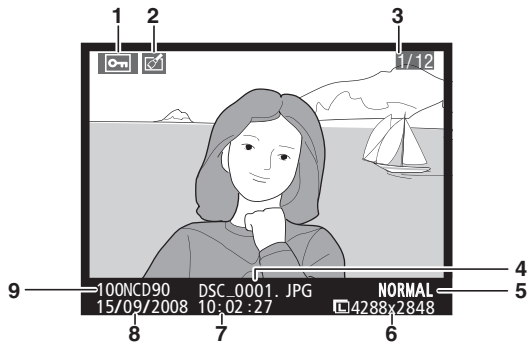


Photo Information

Photo information is superimposed on images displayed in full-frame playback. There are up to eight pages of information for each photo. Press ▲ or ▼ to cycle through photo information as shown below. Note that shooting data, RGB histograms, and highlights are only displayed if corresponding option is selected for **Display mode** (pg. 163). GPS data are only displayed if a GPS device was used when the photo was taken.

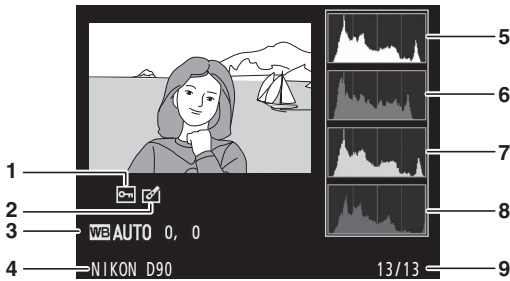


File Information



- | | | |
|---|-------------------------|-----------------------------|
| 1 Protect status..... 139 | 4 File name 61 | 7 Time of recording..... 27 |
| 2 Retouch indicator 209 | 5 Image quality..... 62 | 8 Date of recording..... 27 |
| 3 Frame number/
total number of images | 6 Image size 63 | 9 Folder name..... 162 |

■ ■ RGB Histogram ¹




- 1 Protect status139
- 2 Retouch indicator209
- 3 White balance95
White balance fine-tuning97
- 4 Camera name

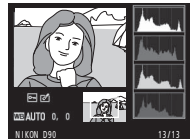
- 5 Histogram (RGB channel).
In all histograms, horizontal axis gives pixel brightness, vertical axis number of pixels.

- 6 Histogram (red channel)
- 7 Histogram (green channel)
- 8 Histogram (blue channel)
- 9 Frame number/
total number of images

1 Displayed only if **RGB histogram** is selected for **Display mode** (pg. 163).

Playback Zoom

To zoom in on the photograph when the histogram is displayed, press  (for more information on playback zoom, see page 138). The histogram will be updated to show only the data for the portion of the image visible in the monitor.



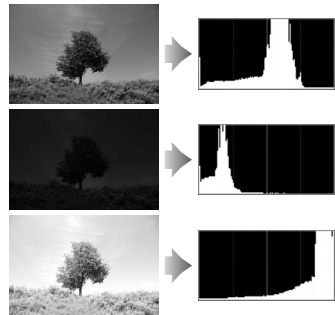
Histograms

Camera histograms are intended as a guide only and may differ from those displayed in imaging applications. Some sample histograms are shown below:

If the image contains objects with a wide range of brightnesses, the distribution of tones will be relatively even.

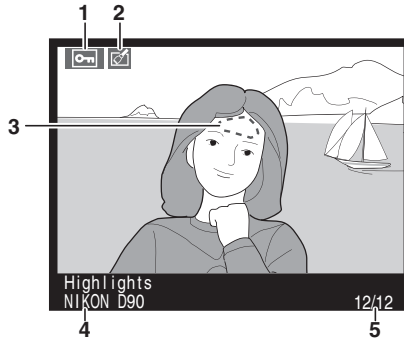
If the image is dark, tone distribution will be shifted to the left.

If the image is bright, tone distribution will be shifted to the right.



Increasing exposure compensation shifts the distribution of tones to the right, while decreasing exposure compensation shifts the distribution to the left. Histograms can provide a rough idea of overall exposure when bright ambient lighting makes it difficult to see photographs in the monitor.

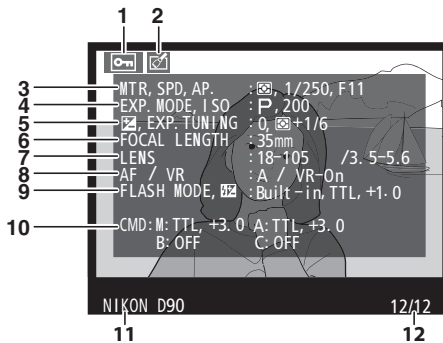
■ Highlights*



- | | | |
|------------------------------|-----------------------------|---|
| 1 Protect status139 | 3 Image highlights163 | 5 Frame number/
total number of images |
| 2 Retouch indicator209 | 4 Camera name | |

* Blinking areas indicate highlights for current channel.

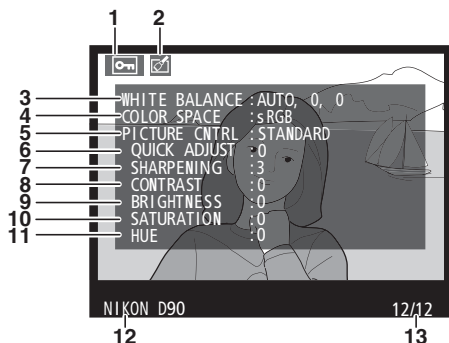
■ Shooting Data Page 1¹



- | | | |
|---|--|---|
| 1 Protect status139 | 5 Exposure
compensation 90 | 9 Flash mode.....71
Flash compensation.....91 |
| 2 Retouch indicator209 | Optimal exposure
tuning ³ 178 | 10 Commander mode/group
name/flash control
mode/flash
compensation 185 |
| 3 Metering87
Shutter speed.....81, 83
Aperture.....82, 83 | 6 Focal length.....228 | |
| 4 Shooting Mode..34, 41, 78
ISO sensitivity ²74 | 7 Lens data | |
| | 8 Focus mode..... 54, 59
Lens VR (vibration
reduction) ⁴ 26 | 11 Camera name |
| | | 12 Frame number/
total number of images |

- 1 Displayed only if **Data** is selected for **Display mode** (pg. 163).
- 2 Displayed in red if photo was taken with ISO sensitivity auto control on.
- 3 Displayed if Custom Setting b4 (**Fine tune optimal exposure**, pg. 178) has been set to a value other than zero for any metering method.
- 4 Displayed only if VR lens is attached.

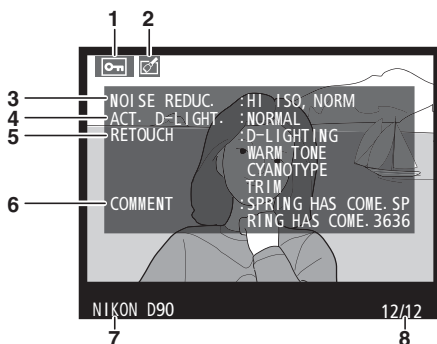
■ Shooting Data Page 2¹



- | | | |
|---|---|--|
| <p>1 Protect status139</p> <p>2 Retouch indicator209</p> <p>3 White balance95
 Color temperature.....99
 White balance fine-
 tuning97
 Preset manual100</p> <p>4 Color space.....167</p> | <p>5 Picture Control108</p> <p>6 Quick adjust²111
 Original Picture
 Control³114</p> <p>7 Sharpening111</p> <p>8 Contrast111</p> <p>9 Brightness111</p> | <p>10 Saturation⁴.....111
 Filter effects⁵111</p> <p>11 Hue⁴111
 Toning⁵111</p> <p>12 Camera name</p> <p>13 Folder number-
 frame number</p> |
|---|---|--|

- 1 Displayed only if **Data** is selected for **Display mode** (pg. 163).
- 2 **Standard, Vivid, Portrait, and Landscape** Picture Controls only.
- 3 **Neutral, Monochrome**, and custom Picture Controls.
- 4 Not displayed with monochrome Picture Controls.
- 5 Monochrome Picture Controls only.

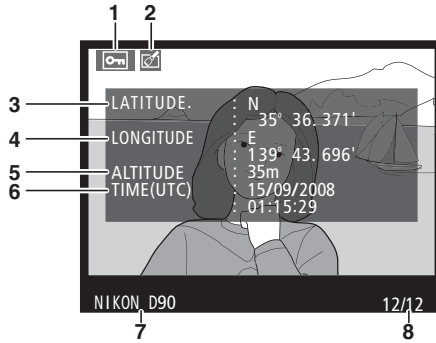
■ Shooting Data Page 3^{*}



- | | | |
|---|--|---|
| <p>1 Protect status139</p> <p>2 Retouch indicator209</p> <p>3 High ISO NR168
 Long exposure NR167</p> | <p>4 Active D-Lighting166</p> <p>5 Retouch history209</p> <p>6 Image comment205</p> <p>7 Camera name</p> | <p>8 Folder number-
 frame number</p> |
|---|--|---|

* Displayed only if **Data** is selected for **Display mode** (pg. 163).

■ ■ GPS Data*

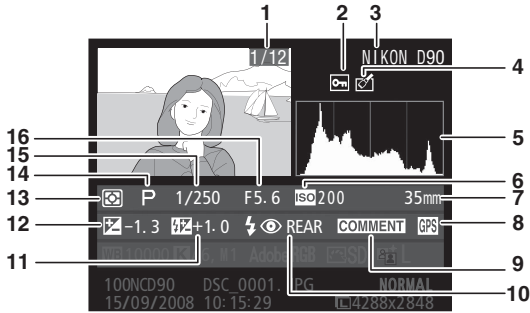


- | | | |
|-------------------------------------|--|---|
| 1 Protect status139 | 5 Altitude | 8 Folder number-
frame number |
| 2 Retouch indicator209 | 6 Coordinated Universal
Time (UTC) | |
| 3 Latitude | 7 Camera name | |
| 4 Longitude | | |

* Displayed only if GPS device was used when photo was taken (pg. 124).

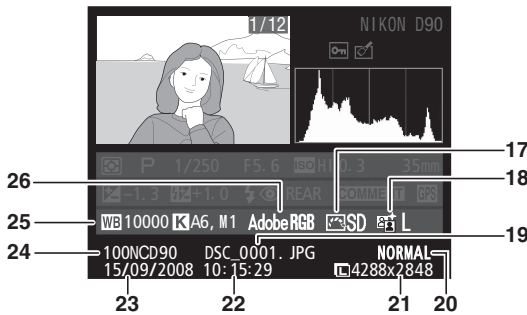


Overview Data




- | | | |
|--|--|--|
| <p>1 Folder number/
frame number</p> <p>2 Protect status139</p> <p>3 Camera name</p> <p>4 Retouch indicator209</p> | <p>5 Histogram showing the
distribution of tones in
the image (pg. 130).
Horizontal axis
corresponds to pixel
brightness, vertical axis
shows number of pixels
of each brightness in
image.</p> <p>6 ISO sensitivity* 74</p> <p>7 Focal length.....228</p> <p>8 GPS data indicator 124</p> | <p>9 Image comment
indicator 205</p> <p>10 Flash mode.....71</p> <p>11 Flash compensation.....91</p> <p>12 Exposure compensation
.....90</p> <p>13 Metering87</p> <p>14 Mode 34, 41, 78</p> <p>15 Shutter speed..... 81, 83</p> <p>16 Aperture..... 82, 83</p> |
|--|--|--|

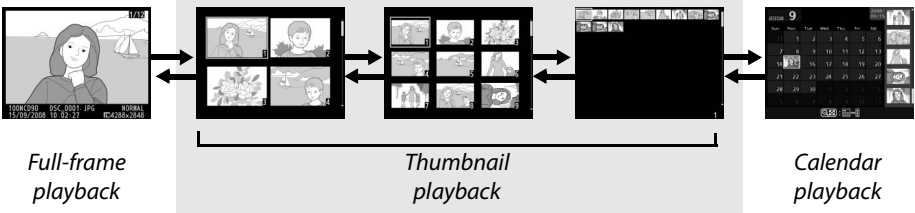
* Displayed in red if photo was taken with ISO sensitivity auto control on.














- | | | |
|--|--|---|
| <p>17 Picture Control.....108</p> <p>18 Active D-Lighting119</p> <p>19 File name 61</p> <p>20 Image quality 63</p> <p>21 Image size.....62</p> <p>22 Time of recording27</p> | <p>23 Date of recording 27</p> <p>24 Folder name 162</p> | <p>25 White balance95
Color temperature.....99
White balance
fine-tuning97
Preset manual 100</p> <p>26 Color space..... 167</p> |
|--|--|---|

Thumbnail Playback


To display images in “contact sheets” of four, nine, or 72 images, press the  button.

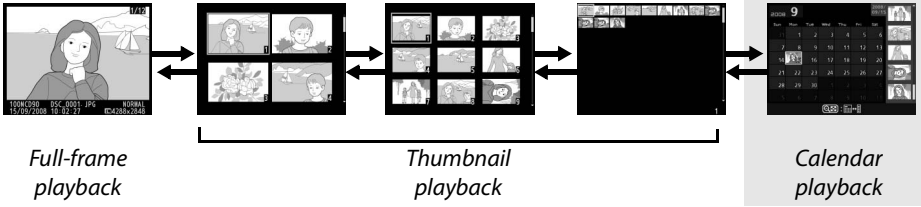



To	Use	Description
Display more images		Press  button to increase the number of images displayed.
Display fewer images		Press  button to reduce the number of images displayed. When four images are displayed, press to view highlighted image full frame.
Highlight images		Use multi selector or command dials to highlight images for full-frame playback, playback zoom (pg. 138), or deletion (pg. 140). Use main command dial to move cursor left or right, sub-command dial to move cursor up or down.
View highlighted image		Press  to display the highlighted image full frame.
Delete highlighted photo		See page 140 for more information.
Change protect status of highlighted photo		See page 139 for more information.
Return to shooting mode	 / 	Monitor will turn off. Photographs can be taken immediately.
Display menus	MENU	See page 159 for more information.

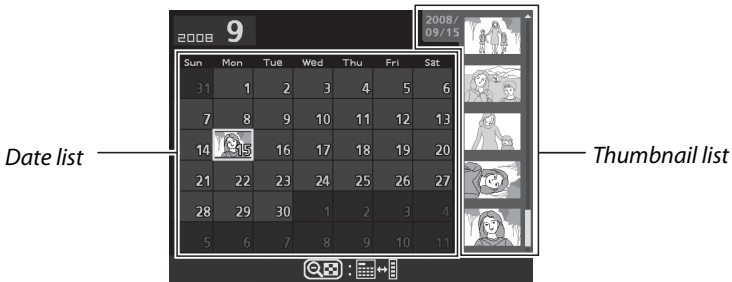


Calendar Playback









To view images taken on a selected date, press the  button when 72 images are displayed.



Press the  button to toggle between the date list and the list of thumbnails for the selected date. Use the multi selector to highlight dates in the date list or to highlight pictures in the thumbnail list.














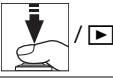
The operations can be performed depend on whether the cursor is in the date list or the thumbnail list:

To	Use	Description
Toggle between date list and thumbnail list		Press  button in date list to place cursor in thumbnail list. Press again to return to date list.
Exit to thumbnail playback/Zoom in on highlighted photo		<ul style="list-style-type: none"> • Date list: Exit to 72-frame playback. • Thumbnail list: Zoom in on highlighted picture.
Toggle full frame playback		<ul style="list-style-type: none"> • Date list: View first picture taken on selected date. • Thumbnail list: View highlighted picture.
Highlight dates/ Highlight images		<ul style="list-style-type: none"> • Date list: Highlight date. • Thumbnail list: Highlight picture.
Delete highlighted photo(s)		<ul style="list-style-type: none"> • Date list: Delete all pictures taken on selected date. • Thumbnail list: Delete highlighted picture (pg. 140).
Change protect status of highlighted photo		See page 139 for more information.
Return to shooting mode		Monitor will turn off. Photographs can be taken immediately.
Display menus	MENU	See page 159 for more information.





Taking a Closer Look: Playback Zoom

Press the  button to zoom in on the image displayed in full-frame playback or on the image currently highlighted in thumbnail or calendar playback. The following operations can be performed while zoom is in effect:

To	Use	Description
Zoom in or out		Press  to zoom in to maximum of approximately 27 × (large images), 20 × (medium images) or 13 × (small images). Press  to zoom out. While photo is zoomed in, use multi selector to view areas of image not visible in monitor. Keep multi selector pressed to scroll rapidly to other areas of frame. Navigation window is displayed when zoom ratio is altered; area currently visible in monitor is indicated by yellow border. 
View other areas of image		
Select faces		Faces (up to 10) detected during zoom are indicated by white borders in navigation window. Rotate sub-command dial to scroll display to faces without changing zoom ratio. 
Cancel zoom		Cancel zoom and return to full-frame playback.
View other images		Rotate main command dial to view same location in other images at current zoom ratio.
Change protect status		See page 139 for more information.
Return to shooting mode		Monitor will turn off. Photographs can be taken immediately.
Display menus	MENU	See page 159 for more information.

Protecting Photographs from Deletion

In full-frame, zoom, thumbnail, and calendar playback, the  button can be used to protect photographs from accidental deletion. Protected files can not be deleted using the  button or the **Delete** option in the playback menu, and have DOS “read-only” status when viewed on a Windows computer. Note that protected images *will* be deleted when the memory card is formatted (pp. 30, 202).



To protect a photograph:

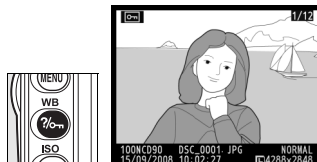
1 Select an image.

Display the image in full-frame playback or playback zoom or highlight it in the thumbnail list.





2 Press the button.


The photograph will be marked with a  icon. To remove protection from the photograph so that it can be deleted, display the photograph or highlight it in the thumbnail list and then press the  button.



Removing Protection from All Images

To remove protection from all images in the folder or folders currently selected in the **Playback folder** menu, press the  and  buttons together for about two seconds.

Deleting Individual Photographs

To delete the photograph displayed in full-frame playback or the photograph highlighted in the thumbnail list, press the  button. Once deleted, photographs can not be recovered.

1 Select an image.

Display the image or highlight it in the thumbnail list.

2 Press the button.



A confirmation dialog will be displayed.



Full-frame playback



Thumbnail playback

To delete the photograph, press the  button again. To exit without deleting the photograph, press the  button.



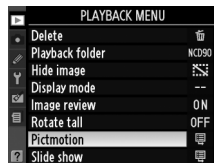
See Also

To delete multiple images, use the **Delete** option in the playback menu (pg. 162). Use calendar playback to delete all pictures taken on a selected date (pg. 136).

Pictmotion

The **Pictmotion** option in the playback menu (pg. 160) is used to create and view slide shows with custom transitions and background music. The following options are available:

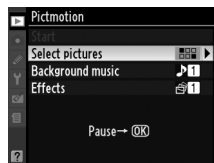
Option	Description
Start	View the completed Pictmotion show.
Select pictures	Choose pictures for the Pictmotion show.
Background music	Choose background music.
Effects	Choose the transitions between pictures.



■ Choosing Pictures

To select the pictures that will be included in the Pictmotion show, choose **Select pictures** in the Pictmotion menu. The following options will be displayed:

Option	Description
Selected	Select individual pictures for the show.
Select date	Select a date. All pictures taken on the selected date will appear in the show.
ALL All	Create a show using all the pictures in the current playback folder.



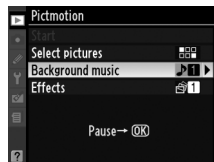
Only pictures in the folder currently selected in the **Playback folders** (pg. 162) menu can be included in the show. Hidden pictures and pictures that can not be viewed on the camera will not be displayed.

■ Movies

Pictmotion shows can include movies, but only the first few seconds of each movie will be displayed.

■ Choosing Background Music

To choose background music for the Pictmotion show, select **Background music** in the Pictmotion menu. Choose from **High-speed, Emotional, Natural, Up-tempo,** and **Relaxed.**



■ Transitions

To choose the transitions between pictures in the Pictmotion show, select **Effects** in the Pictmotion menu. Choose from **Zoom bounce, Zoom in/out, Blend, Wipe,** and **Zoom out fade.**

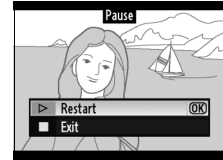
■ Viewing the Pictmotion Show

To view the show, highlight **Start** in the Pictmotion menu and press **OK**. The following operations can be performed while the show is in progress:



To	Use	Description
Pause slide show	OK	Pause show (see below).
Raise volume		Press and to raise and lower volume.
Lower volume		
Exit to playback menu	MENU	See page 159 for more information.
Exit to playback mode		End show and return to playback mode.
Exit to shooting mode		Press shutter-release button halfway to return to shooting mode.

A dialog shown at right is displayed when the show ends or when the **OK** button is pressed to pause playback. Select **Restart** to restart (if the show was paused, it will resume from the next picture) or **Exit** to return to the playback menu.



■ Transitions





Depending on the size of the images, transitions may not be displayed.

Slide Shows

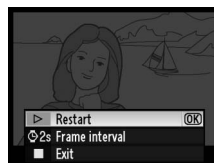
The **Slide show** option in the playback menu (pg. 164) is used to display a slide show of the pictures in the current playback folder (pg. 162). Hidden images (pg. 162) are not displayed.

Option	Description
Start	Start slide show.
Frame interval	Choose how long each picture will be displayed.

To start the slide show, highlight **Start** in the slide show menu and press **OK**. The following operations can be performed while the slide show is in progress:

To	Use	Description
Skip back/skip ahead		Press ◀ to return to previous frame, ▶ to skip to next frame.
View additional photo info		Change photo info displayed (pg. 129).
Pause slide show	OK	Pause show (see below).
Exit to playback menu	MENU	See page 159 for more information.
Exit to playback mode		End show and return to playback mode.
Exit to shooting mode		Press shutter-release button halfway to return to shooting mode.

A dialog shown at right is displayed when the show ends or when the **OK** button is pressed to pause playback. Select **Restart** to restart (if the show was paused, it will resume from the next slide) or **Exit** to return to the playback menu.







Connections

This chapter describes how to copy photographs to a computer, how to print pictures, and how to view them on a television set.

Viewing Photographs on TV	146
Standard Definition Devices	146
High-Definition Devices	147
Connecting to a Computer	148
Before Connecting the Camera	148
Connecting the Camera.....	149
Printing Photographs	150



Viewing Photographs on TV

The supplied EG-D2 audio video cable can be used to connect the camera to a television or VCR for playback or recording. A type C mini-pin High-Definition Multimedia Interface (HDMI) cable (available separately from third-party suppliers) can be used to connect the camera to high-definition video devices.

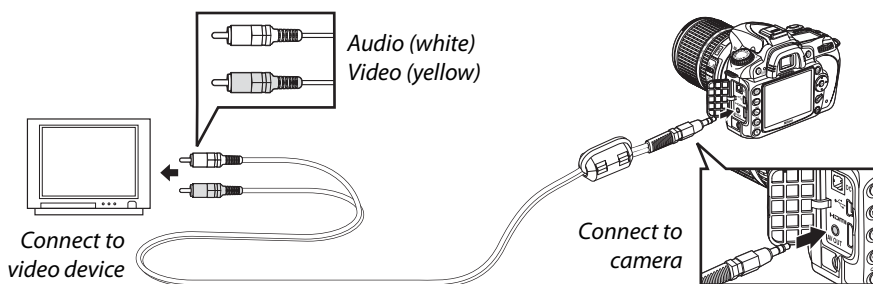
Standard Definition Devices

To connect the camera to a standard television:

1 Turn the camera off.

Always turn the camera off before connecting or disconnecting the video cable.

2 Connect the supplied audio video cable as shown.



3 Tune the television to the video channel.

4 Turn the camera on and press the button.

During playback, images will be displayed both in the camera monitor and on the television screen.

Video Mode (pg. 203)

Be sure that the video standard matches the standard used in the video device. Note that resolution will drop when images are output on a PAL device.

Television Playback

Use of an EH-5a or EH-5 AC adapter (available separately) is recommended for extended playback. When the EH-5a or EH-5 is connected, the camera monitor-off delay will be fixed at ten minutes and the exposure meters will no longer turn off automatically. Note that the edges may not be visible when photographs are viewed on a television screen.

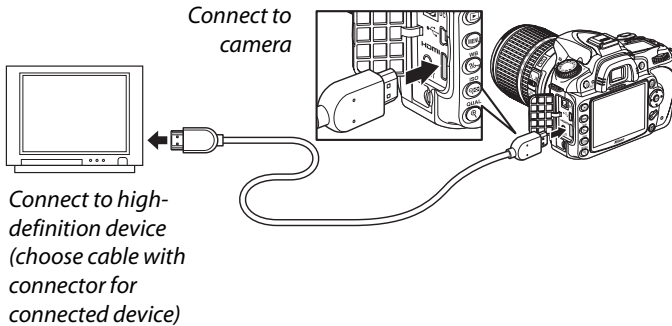
High-Definition Devices

The camera can be connected to HDMI devices using a type C mini-pin HDMI cable (available separately from third-party suppliers).

1 Turn the camera off.

Always turn the camera off before connecting or disconnecting an HDMI cable.

2 Connect the HDMI cable as shown.



3 Tune the device to the HDMI channel.

4 Turn the camera on and press the button.

During playback, images will be displayed on the high-definition television or monitor screen; the camera monitor will remain off.

HDMI (pg. 203)

At the default setting of **Auto**, the camera automatically selects the appropriate HDMI format for the high-definition device. The HDMI format can be chosen using the **HDMI** option in the setup menu (pg. 203).

Connecting to a Computer

This section describes how to use the supplied UC-E4 USB cable to connect the camera to a computer.

Before Connecting the Camera

Before connecting the camera, install the software on the supplied Software Suite CD (see the *Install Guide* for more information). To ensure that data transfer is not interrupted, be sure the camera battery is fully charged. If in doubt, charge the battery before use or use an EH-5a or EH-5 AC adapter (available separately).

Supported Operating Systems

The camera can be connected to computers running the following operating systems:

- **Windows:** Windows Vista Service Pack 1 (32-bit Home Basic/Home Premium/Business/Enterprise/Ultimate) and Windows XP Service Pack 3 (Home Edition/Professional). Users of Windows 2000 Professional Service Pack 4 can transfer pictures by inserting the camera memory card in a card reader or card slot.
- **Macintosh:** Mac OS X (version 10.3.9, 10.4.11, 10.5.3)

See the websites listed on page xviii for the latest information on supported operating systems.

Supplied Software

Nikon Transfer is used to copy photographs from the camera to the computer, where they can be viewed using ViewNX (Nikon Transfer can also be used to back up photographs and embed information in photographs as they are transferred, while ViewNX can be used to sort photographs, convert images to different file formats, and perform simple editing on NEF/RAW photographs).

Connecting Cables

Be sure the camera is off when connecting or disconnecting interface cables. Do not use force or attempt to insert the connectors at an angle.

During Transfer

Do not turn the camera off or disconnect the USB cable while transfer is in progress.

Camera Control Pro 2

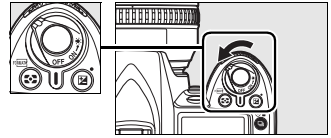
Camera Control Pro 2 (available separately; pg. 240) can be used to control the camera from a computer. When Camera Control Pro 2 is running, "P L" will be displayed in the control panel.

Connecting the Camera

Connect the camera using the supplied UC-E4 USB cable.

1 Turn the camera off.

Power switch

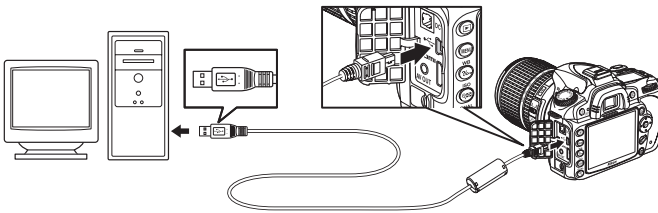


2 Turn the computer on.

Turn the computer on and wait for it to start up.

3 Connect the USB cable.

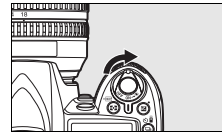
Connect the USB cable as shown. Do not use force or attempt to insert the connectors at an angle.



USB Hubs

Connect the camera directly to the computer; do not connect the cable via a USB hub or keyboard.

4 Turn the camera on.



5 Transfer photographs.

Nikon Transfer will start automatically; click the **Start Transfer** button to transfer photographs (for more information on using Nikon Transfer, select **Nikon Transfer help** from the Nikon Transfer **Help** menu).

6 Turn the camera off and disconnect the USB cable when transfer ends.

Nikon Transfer will close automatically when transfer is complete.

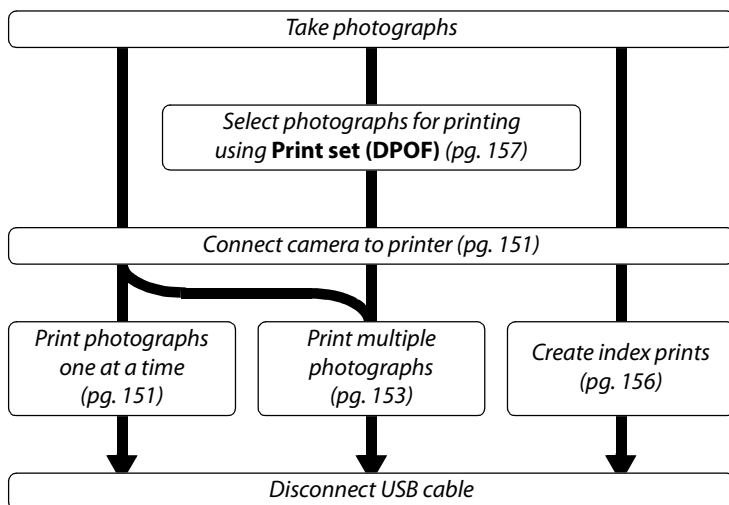
Printing Photographs

JPEG photographs can be printed by any of the following methods:

- Connect the camera to a printer and print photographs directly from the camera (see below).
- Insert the camera memory card in a printer equipped with a card slot (see the printer manual for details). If the printer supports DPOF (pg. 274), photographs can be selected for printing using **Print set (DPOF)** (pg. 157).
- Take the camera memory card to a developer or digital printer center. If the center supports DPOF (pg. 274), photographs can be selected for printing using **Print set (DPOF)** (pg. 157).
- Transfer pictures (pg. 148) and print them from a computer using ViewNX (supplied; pg. 148) or Capture NX 2 (available separately; pg. 240).

NEF (RAW) photographs can only be printed using ViewNX or Capture NX 2 as described above or by printing JPEG copies created using the **NEF (RAW) processing** option in the retouch menu (pg. 220).

To print selected JPEG pictures on a PictBridge printer via a direct USB connection, follow the steps below.



Printing Via Direct USB Connection

Be sure the battery is fully charged or use an optional EH-5a or EH-5 AC adapter. When taking photographs to be printed via direct USB connection in **P**, **S**, **A**, and **M** modes, set **Color space** to **sRGB** (pg. 167).

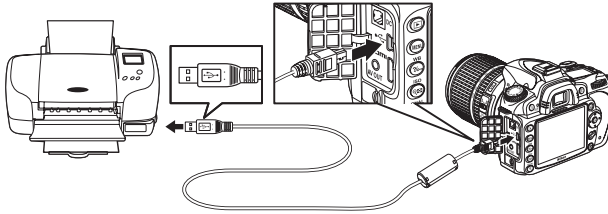
■ Connecting the Printer

Connect the camera using the supplied UC-E4 USB cable.

1 Turn the camera off.

2 Connect the USB cable.

Turn the printer on and connect the USB cable as shown. Do not use force or attempt to insert the connectors at an angle.

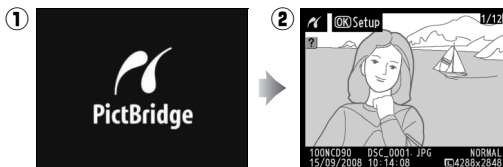


✓ USB Hubs

Connect the camera directly to the printer; do not connect the cable via a USB hub or keyboard.





3 Turn the camera on.

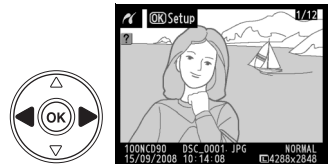
A welcome screen will be displayed in the monitor, followed by a PictBridge playback display.



■ Printing Pictures One at a Time

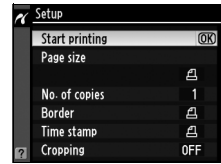
1 Select a picture.

Press ◀ or ▶ to view additional pictures, or press ▲ or ▼ to view photo information (pg. 129). Press the  button to zoom in on the current frame (pg. 138; press  to exit zoom). To view six pictures at a time, press the  button. Use the multi selector to highlight pictures, or press  to display the highlighted picture full frame.



2 Display printing options.

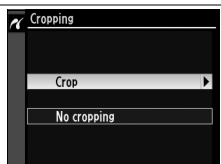
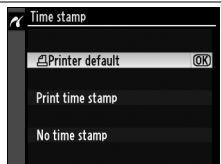
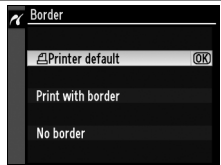
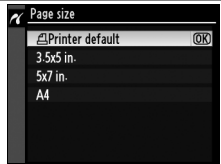
Press **OK** to display PictBridge printing options.



3 Adjust printing options.

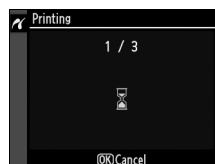
Press **▲** or **▼** to highlight an option and press **▶** to select.

Option	Description
Page size	Menu of page sizes will be displayed (options not supported by current printer are not listed). Press ▲ or ▼ to choose page size (to print at default page size for current printer, select Printer default), then press OK to select and return to previous menu.
No. of copies	Menu shown at right will be displayed. Press ▲ or ▼ to choose number of copies (maximum 99), then press OK to select and return to previous menu.
Border	Menu shown at right will be displayed. Press ▲ or ▼ to choose print style from Printer default (print using current printer settings), Print with border (print photo with white border), or No border , then press OK to select and return to previous menu. Only options supported by current printer will be displayed.
Time stamp	Menu shown at right will be displayed. Press ▲ or ▼ to choose Printer default (print using current printer settings), Print time stamp (print time and date of recording on photo), or No time stamp , then press OK to select and return to previous menu. Only options supported by current printer will be displayed.
Cropping	Menu shown at right will be displayed. To exit without cropping picture, highlight No cropping and press OK . To crop picture, highlight Crop and press ▶ . If Crop is selected, dialog shown at right will be displayed. Press ⏏ to increase size of crop, ⏏ to decrease. Choose position of crop using multi selector and press OK . Note that print quality may drop if small crops are printed at large sizes.



4 Start printing.

Select **Start printing** and press **OK** to start printing. To cancel before all copies have been printed, press **OK**.



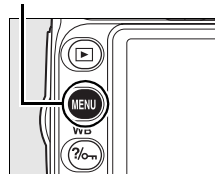
■ Printing Multiple Pictures

1 Display the PictBridge menu.

Press the **MENU** button in the PictBridge playback display (see Step 3 on page 151).



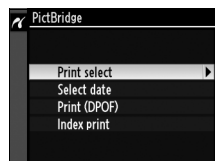
MENU button



2 Choose an option.









Highlight one of the following options and press **▶**.

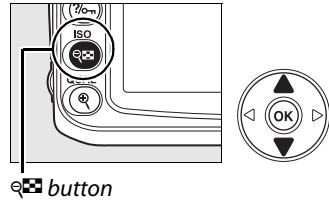
- Print select**: Select pictures for printing.
- Select date**: Print one copy of all the pictures taken on a selected date.
- Print (DPOF)**: Print an existing print order created with the **Print set (DPOF)** option in the playback menu (pg. 160). The current print order will be displayed in Step 3.




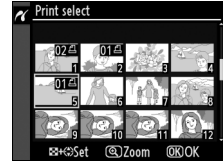
To create an index print of all JPEG pictures on the memory card, select **Index print**. See page 156 for more information.






3 Select pictures or choose a date.

If you chose **Print select** or **Print (DPOF)** in Step 2, use the multi selector to scroll through the pictures on the memory card. To display the current picture full screen, press the  button. To select the current picture for printing, press the  button and press . The picture will be marked with a  icon and the number of prints will be set to 1. Keeping the  button pressed, press  or  to specify the number of prints (up to 99; to deselect the picture, press  when the number of prints is 1). Continue until all the desired pictures have been selected.



 button

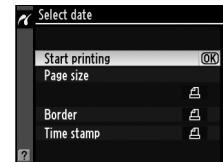


If you chose **Select date** in Step 2, press  or  to highlight a date and press  to select. To view the pictures taken on the selected date, press . Use the multi selector to scroll through the pictures, or press  to view the current picture full screen.



4 Display printing options.

Press  to display PictBridge printing options.



5 Adjust printing options.

Press ▲ or ▼ to highlight an option and press ► to select.

Option	Description
Page size	Menu of page sizes will be displayed (pg. 152; options not supported by current printer are not listed). Press ▲ or ▼ to choose page size (to print at default page size for current printer, select Printer default), then press OK to select and return to previous menu.
Border	Menu of border options will be displayed (pg. 152; options not supported by current printer are not listed). Press ▲ or ▼ to choose print style from Printer default (print at current printer settings), Print with border (print photo with white border), or No border , then press OK to select and return to previous menu.
Time stamp	Menu of time stamp options will be displayed (pg. 152; options not supported by current printer are not listed). Press ▲ or ▼ to choose Printer default (print at current printer settings), Print time stamp (print time and date of recording on photo), or No time stamp , then press OK to select and return to previous menu.

6 Start printing.

Select **Start printing** and press **OK** to start printing. To cancel before all copies have been printed, press **OK**.



✔ Selecting Photographs for Printing

NEF (RAW) photographs (pg. 62) can not be selected for printing. JPEG copies of NEF (RAW) images can be created using the **NEF (RAW) processing** option in the retouch menu.

✍ See Also

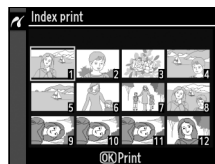
See page 250 for information on what to do if an error occurs during printing.

■ ■ Creating Index Prints

To create an index print of all JPEG pictures on the memory card, select **Index print** in Step 2 of "Printing Multiple Pictures" (pg. 153). Note that if the memory card contains more than 256 pictures, only the first 256 images will be printed.

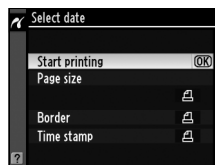
1 Select Index print.

Selecting **Index print** in the PictBridge menu (pg. 153) displays the images on the memory card as shown at right.



2 Display printing options.

Press **OK** to display PictBridge printing options.



3 Adjust printing options.

Choose page size, border, and time stamp options as described on page 147 (a warning will be displayed if the selected page size is too small).

4 Start printing.

Select **Start printing** and press **OK** to start printing. To cancel before all copies have been printed, press **OK**.

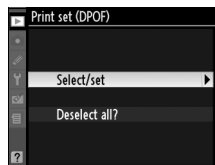


■ Creating a DPOF Print Order: Print Set


The **Print set (DPOF)** option in the playback menu is used to create digital “print orders” for PictBridge-compatible printers and devices that support DPOF. Selecting **Print set (DPOF)** from the playback menu displays the menu shown in Step 1.

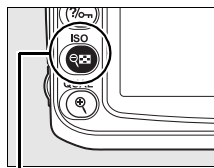
1 Choose Select/set.


Highlight **Select/set** and press **▶**.



2 Select pictures.

Use the multi selector to scroll through the pictures on the memory card. To display the current picture in full screen, press **Q** button. To select the current picture for printing, press the **Q** button and press **▲**. The picture will be marked with a  icon and the number of prints will be set to 1. Keeping the **Q** button pressed, press **▲** or **▼** to specify the number of prints (up to 99; to deselect the picture, press **▼** when the number of prints is 1). Press **OK** when all the desired pictures have been selected.



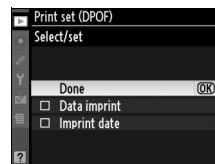
 button



3 Select imprint options.

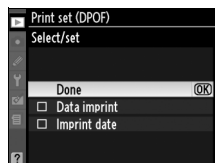
Highlight the following options and press **▶** to toggle the highlighted option on or off (to complete the print order without including this information, proceed to Step 4).

- **Data imprint:** Print shutter speed and aperture on all pictures in print order.
- **Imprint date:** Print date of recording on all pictures in print order.



4 Complete the print order.

Highlight **Done** and press **OK** to complete the print order.



✔ **Print Set (DPOF)**

To print the current print order when the camera is connected to a PictBridge printer, select **Print (DPOF)** in the PictBridge menu and follow the steps in “Printing Multiple Pictures” to modify and print the current order (pg. 153). DPOF date and data imprint options are not supported when printing via direct USB connection; to print the date of recording on photographs in the current print order, use the PictBridge **Time stamp** option.

The **Print set (DPOF)** option can not be used if there is not enough space on the memory card to store the print order.

NEF (RAW) photographs (pg. 62) can not be selected using this option. JPEG copies of NEF (RAW) images can be created using the **NEF (RAW) processing** option in the retouch menu.







Print orders may not print correctly if images are deleted using a computer or other device after the print order is created.





Menu Guide

The current menu is displayed by pressing the **MENU** button; to select from the menus listed below, press **◀**. This chapter describes the options available in the menus below.

 The Playback Menu: Managing Images	160
 The Shooting Menu: Shooting Options	165
 Custom Settings: Fine-Tuning Camera Settings	171
 The Setup Menu: Camera Setup	202
 The Retouch Menu: Creating Retouched Copies	209
 Recent Settings/My Menu	224



▶ The Playback Menu: Managing Images

The playback menu contains the options listed below. To display the playback menu, press MENU and press ◀ to highlight the tab for current menu, then press ▲ or ▼ to highlight the playback menu tab; for more information, see page 19.

Option	See page	Option	See page
Delete	162	Rotate tall	163
Playback folder	162	Pictmotion	141
Hide image	162	Slide show	143
Display mode	163	Print set (DPOF)	157
Image review	163		

Selecting Multiple Pictures

To select multiple pictures for **Delete** (pg. 162), **Hide image** (pg. 162), **Pictmotion** (pg. 163), and direct printing (pg. 150):

■ Thumbnail Selection

To choose pictures from a list of thumbnails, select the “Selected,” “Select/Set,” “Print select,” or “Print (DPOF)” option and follow the steps below.

1 Highlight a picture.

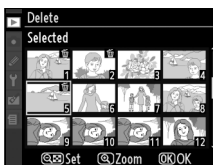
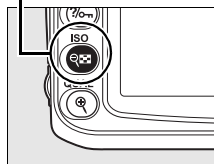
Use the multi selector to highlight a picture (to view the highlighted picture full screen, press and hold the Ⓞ button).



2 Select the highlighted picture.

Press the Ⓞ button to select the highlighted picture. Selected pictures are marked by an icon. When selecting pictures for printing, press the Ⓞ button and press ▲ or ▼ to choose the number of copies.

Ⓞ button



3 Repeat steps 1 and 2 to select additional pictures.

To deselect a picture, highlight it and press the Ⓞ button.

4 Press **OK** to complete the operation.

A confirmation dialog will be displayed; highlight **Yes** and press **OK**.



■ ■ **Date Selection**

To choose a date, select the "Select date" option and follow the steps below.

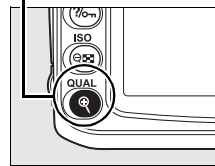
1 Highlight a date.

Press **▲** or **▼** to highlight a date.



To view the pictures taken on the highlighted date, press **Q**. Use the multi selector to scroll through the pictures, or press **Q** to view the current picture full screen. Press **Q** to return to the date list.

Q button



2 Select the highlighted date.

Press **▶** in the date list or **OK** in the thumbnail list to select all pictures taken on the highlighted date. Selected dates are marked with a icon.

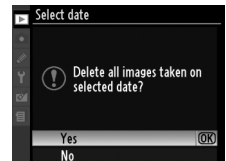


3 Repeat steps 1 and 2 to select additional pictures.

To deselect a date, highlight it and press **▶**. To deselect a selected date in the thumbnail list, press **OK**.



4 Press **OK** to complete the operation.

A confirmation dialog will be displayed; highlight **Yes** and press **OK**.



Delete

The delete menu contains the following options:

Option	Description
 Selected	Delete selected pictures.
 Select date	Delete all pictures taken on a selected date.
ALL All	Delete all pictures in the folder currently selected for playback.

Protected and Hidden Images

Images that are protected or hidden will not be deleted.



Playback Folder

Choose a folder for playback:

Option	Description
Current (default)	Only photos in the folder currently selected for Active folder in the shooting menu are displayed during playback. This option is selected automatically when a photo is taken. If a memory card is inserted and this option selected before photos have been taken, a message stating that the folder contains no images will be displayed during playback. Select All to begin playback.
All	Pictures in all folders will be visible during playback.

Hide Image

Hide or reveal selected pictures. Hidden pictures are visible only in the **Hide image** menu and can only be deleted by formatting the memory card.

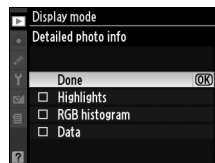
Option	Description
 Select/set	Hide or reveal selected pictures.
 Select date	Hide or reveal all pictures taken on a selected date.
ALL Deselect all?	Reveal all pictures.

Protected and Hidden Images

Revealing a protected image will also remove protection from the image.

Display Mode


Choose the information available in the playback photo information display (pg. 129). Press ▲ or ▼ to highlight an option, then press ► to select the option for the photo information display. A appears next to selected items; to deselect, highlight and press ►. To return to the playback menu, highlight **Done** and press **OK**.



Option	Description
Detailed photo info	
Highlights	Highlights are shown in photo information display. Very bright areas blink on and off.
RGB histogram	Red, green, and blue histograms are displayed in photo information display.
Data	Shooting data pages (including camera name, metering, exposure, focal length, white balance, and image options) appear in photo information display.

Image Review

Choose whether pictures are automatically displayed in the monitor immediately after shooting.

Option	Description
On (default)	Pictures are automatically displayed in the monitor after shooting.
Off	Pictures can only be displayed by pressing  button.

Rotate Tall

Choose whether to rotate “tall” (portrait-orientation) pictures for display during playback. Note that because the camera itself is already in the appropriate orientation during shooting, images are not rotated automatically during image review (pg. 128).

Option	Description
On (default)	“Tall” (portrait-orientation) pictures are automatically rotated for display in the camera monitor. Pictures taken with Off selected for Auto image rotation (pg. 205) will be displayed in “wide” (landscape) orientation.
Off	“Tall” (portrait-orientation) pictures are displayed in “wide” (landscape) orientation.

Pictmotion

Create and view slide shows with custom transitions and background music (pg. 141).

Slide Show

Play pictures back one at a time in a simple automated slide show (pg. 143).

Print Set (DPOF)

Choose **Select/set** to select pictures for printing on a DPOF-compatible device (pg. 157). Choose **Deselect all?** to remove all pictures from the current print order.



The Shooting Menu: Shooting Options

The shooting menu contains the options listed below. To display the shooting menu, press **MENU** and press ◀ to highlight the tab for current menu, then press ▲ or ▼ to highlight the shooting menu tab; for more information, see page 19.

Option	See page	Option	See page
Set Picture Control	108	Color space	167
Manage Picture Control	113	Long exp. NR	167
Image quality	62	High ISO NR	168
Image size	63	Active folder	169
White balance	95	Multiple exposure	121
ISO sensitivity settings	166	Movie setting	170
Active D-Lighting	119		

Set Picture Control

Select from the Picture Controls provided with the camera to instantly adjust image processing settings (pg 108). This option is available in **P**, **S**, **A**, and **M** modes only.

Manage Picture Control

Save and modify custom Picture Control combinations, or copy custom Picture Controls to or from the memory card (pg. 113). This option is available in **P**, **S**, **A**, and **M** modes only.

Image Quality

Choose image quality (pg. 62). This option is available in all modes.

Image Size

Choose the size at which pictures are recorded (pg. 63). This option is available in all modes.

White Balance

Adjust white balance settings (pg. 95). This option is available in **P**, **S**, **A**, and **M** modes only.

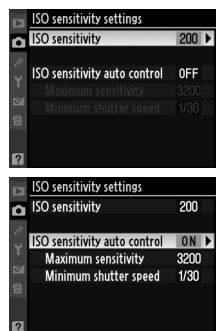


ISO Sensitivity Settings

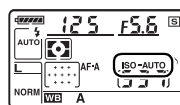
Adjust ISO sensitivity (pg. 74). This option is available in all modes.

■ ISO Sensitivity Auto Control (P, S, and A Modes Only)

If **Off** (the default setting) is chosen for **ISO sensitivity auto control**, ISO sensitivity will remain fixed at the value selected by the user (see page 74). When **On** is chosen, ISO sensitivity will automatically be adjusted if optimal exposure can not be achieved at the value selected by the user (flash level is adjusted appropriately). The maximum value for auto ISO sensitivity can be selected using the **Maximum sensitivity** option in the **ISO sensitivity auto control** menu (choose lower values to prevent noise; the minimum value for auto ISO sensitivity is automatically set to ISO 200). In exposure modes **P** and **A**, sensitivity will only be adjusted if underexposure would result at the shutter speed selected for **Minimum shutter speed**. Slower shutter speeds will be used only if optimum exposure can not be achieved at the ISO sensitivity value selected for **Maximum sensitivity**.



When **On** is selected, the control panel and viewfinder show **ISO-AUTO**. These indicators blink when sensitivity is altered from the value selected by the user.



✍ Auto ISO Sensitivity Control

Noise is more likely at higher sensitivities. Use the **High ISO NR** option in the shooting menu to reduce noise (see page 168). Foreground subjects may be underexposed in photos taken with the flash at slow shutter speeds, in daylight, or against a bright background. Choose a flash mode other than slow sync or select exposure mode **A** or **M** and choose a larger aperture. Note that when the flash is used, the camera uses the shutter speed selected for Custom Setting e1 (**Flash shutter speed**, pg. 185) in place of the value selected for **Minimum shutter speed**.

Active D-Lighting

This option can be used to prevent loss of detail in highlights and shadows (pg. 119). The default setting is **Auto**. This option is available in **P**, **S**, **A**, and **M** modes only.

Color Space

The color space determines the gamut of colors available for color reproduction. Choose a color space according to how photographs will be processed on leaving the camera. This option is available in all modes.

Option	Description
sRGB sRGB (default)	Choose for photographs that will be printed or used “as is,” with no further modification.
Adobe Adobe RGB	This color space is capable of expressing a wider gamut of colors than sRGB, making it the preferred choice for images that will be extensively processed or retouched.

Color Space

Color spaces define the correspondence between colors and the numeric values that represent them in a digital image file. The sRGB color space is widely used, while the Adobe RGB color space is typically used in publishing and commercial printing. sRGB is recommended when taking photographs that will be printed without modification or viewed in applications that do not support color management, or when taking photographs that will be printed with ExifPrint, the direct printing option on some household printers, or kiosk printing or other commercial print services. Adobe RGB photographs can also be printed using these options, but colors will not be as vivid.

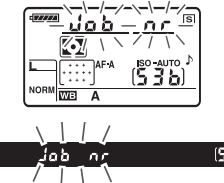
JPEG photographs taken in the Adobe RGB color space are DCF compliant; applications and printers that support DCF will select the correct color space automatically. If the application or device does not support DCF, select the appropriate color space manually. For more information, see the documentation provided with the application or device.

Nikon Software

ViewNX (supplied) and Capture NX 2 (available separately) automatically select the correct color space when opening photographs created with this camera.

Long Exp. NR (Long Exposure Noise Reduction)

Choose whether to reduce noise in pictures taken at slow shutter speeds. This option is available in all modes.

Option	Description
On	<p>Photographs taken at shutter speeds slower than 8 s are processed to reduce noise. The time required for processing is roughly equal to the current shutter speed; during processing, “Long Exp. NR” will blink in the shutter speed/aperture displays and photographs can not be taken. In continuous release mode, frame rates will slow and the capacity of the memory buffer will drop. Noise reduction is not visible in pictures played back before processing is complete; noise reduction will not be performed if the camera is turned off before processing is complete.</p> 
Off (default)	Long exposure noise reduction off.



High ISO NR

Photographs taken at high ISO sensitivities can be processed to reduce “noise.” This option is available in all modes.

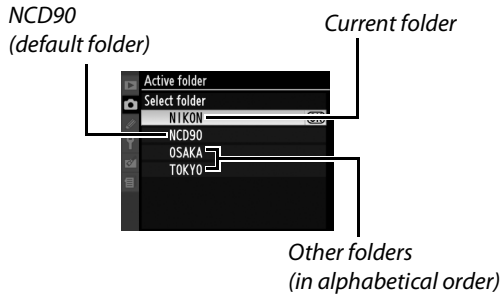
Option	Description
HIGH High	Noise reduction is performed at ISO sensitivities of ISO 800 and higher. While photographs are being processed, the capacity of the memory buffer will drop. Choose the amount of noise reduction performed from High , Normal , and Low .
NORM Normal (default)	
LOW Low	
Off	Noise reduction is only performed at sensitivities of Hi 0.3 and higher. The amount of noise reduction is less than the amount performed when Low is selected for High ISO NR .



Active Folder

Create, rename, or delete folders, or choose the folder in which subsequent photographs will be stored. This option is available in all modes.

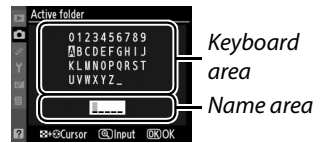
- **Select folder:** Choose the folder in which subsequent photographs will be stored.



- **New:** Create a new folder and name it as described below.
- **Rename:** Select a folder from the list and rename it as described below.
- **Delete:** Delete all empty folders on the memory card.

■ Naming and Renaming Folders

Folder names can be up to five characters long. To move the cursor in the name area, press the button and press ◀ or ▶. To enter a new letter at the current cursor position, use the multi selector to highlight the desired character in the keyboard area and press the button. To delete the character at the current cursor position, press the button. Press to save changes and return to the shooting menu, or press **MENU** to exit without creating a new folder or changing the folder name.



✓ Folder Names

On the memory card, folder names are preceded by a three-digit folder number assigned automatically by the camera (e.g., 100NCD90). Each folder can contain up to 999 photographs. During shooting, pictures are stored in the highest-numbered folder with the selected name. If a photograph is taken when the current folder is full or contains a photograph numbered 9999, the camera will create a new folder by adding one to the current folder number (e.g., 101NCD90). The camera treats folders with the same name but different folder numbers as the same folder. For example, if the folder NIKON is selected for **Active folder**, photographs in all folders named NIKON (100NIKON, 101NIKON, 102NIKON, etc.) will be visible when **Current** is selected for **Playback folder** (pg. 162). Renaming changes all folders with the same name but leaves the folder numbers intact.

Multiple Exposure




Create a single photograph from two to three exposures (pg. 121). This option is available in **P**, **S**, **A**, and **M** modes only.

Movie setting

Choose a frame size and sound options for movies (pg. 50). This option is available in all modes.

■ ■ *Quality*

Choose a frame size.

Option	Description
 1280×720 (16:9)	Record movies at a frame rate of 24 fps. Each frame is 1280 × 720 pixels in size. Choose for higher quality.
 640×424 (3:2) (default)	Record movies at a frame rate of 24 fps. Each frame is 640 × 424 pixels in size.
 320×216 (3:2)	Record movies at a frame rate of 24 fps. Each frame is 320 × 216 pixels in size. Choose for reduced file size.

■ ■ *Sound*

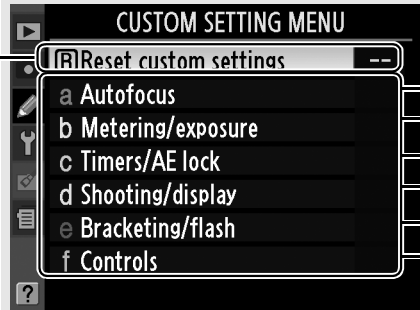
Choose **On** (the default setting) to record monaural sound with movies, **Off** to record silent movies.



Custom Settings: Fine-Tuning Camera Settings

Custom Settings are used to customize camera settings to suit individual preferences. To display the Custom Settings menu, press MENU and press ◀ to highlight the tab for current menu, then press ▲ or ▼ to highlight the Custom Settings tab; for more information, see page 19.

Main menu



CUSTOM SETTING MENU

Reset custom settings

- a Autofocus
- b Metering/exposure
- c Timers/AE lock
- d Shooting/display
- e Bracketing/flash
- f Controls


Reset custom settings

Yes

No

[a]: Reset custom settings (pg. 172)

Custom Setting groups



a Autofocus

- a1 AF-area mode
- a2 Center focus point
- a3 Built-in AF-assist illuminator
- a4 AF point illumination
- a5 Focus point wrap-around
- a6 AE-L/AF-L for MB-D80
- a7 Live view autofocus
- a8 EV steps for exposure cntrl.

b Metering/exposure

- b1 EV steps for exposure cntrl.
- b2 Easy exposure compensation
- b3 Center-weighted area
- b4 Fine tune optimal exposure
- c1 Shutter-release button AEL
- c2 Auto meter-off delay
- c3 Self-timer
- c4 Monitor off delay

c Timers/AE lock

- c1 Shutter-release button AEL
- c2 Auto meter-off delay
- c3 Self-timer
- c4 Monitor off delay
- c5 Remote on duration
- d1 Beep
- d2 Viewfinder grid display
- d3 ISO display and adjustment

d Shooting/display

- d1 Beep
- d2 Viewfinder grid display
- d3 ISO display and adjustment
- d4 Viewfinder warning display
- d5 Screen tips
- d6 CL mode shooting speed
- d7 File number sequence
- d8 Shooting info display

e Bracketing/flash


- e1 Flash shutter speed
- e2 Flash cntrl for built-in flash
- e3 Modeling flash
- e4 Auto bracketing set
- e5 Auto FP
- e6 Bracketing order
- f1 *switch
- f2 OK button (shooting mode)

f Controls

- f1 *switch
- f2 OK button (shooting mode)
- f3 Assign FUNC. button
- f4 Assign AE-L/AF-L button
- f5 Customize command dials
- f6 No memory card?
- f7 Reverse indicators

The following Custom Settings are available:

Custom Setting	Page
Ⓡ Reset custom settings	172
a Autofocus	
a1 AF-area mode	172
a2 Center focus point	174
a3 Built-in AF-assist illuminator	174
a4 AF point illumination	175
a5 Focus point wrap-around	175
a6 AE-L/AF-L for MB-D80	176
a7 Live view autofocus	176
b Metering/exposure	
b1 EV steps for exposure cntrl.	177
b2 Easy exposure compensation	177
b3 Center-weighted area	178
b4 Fine tune optimal exposure	178
c Timers/AE lock	
c1 Shutter-release button AE-L	179
c2 Auto meter-off delay	179
c3 Self-timer	179
c4 Monitor off delay	180
c5 Remote on duration	180
d Shooting/display	
d1 Beep	180
d2 Viewfinder grid display	181
d3 ISO display and adjustment	181

Custom Setting	Page
d Shooting/display	
d4 Viewfinder warning display	181
d5 Screen tips	182
d6 CL mode shooting speed	182
d7 File number sequence	182
d8 Shooting info display	183
d9 LCD illumination	183
d10 Exposure delay mode	183
d11 Flash warning	183
d12 MB-D80 battery type	184
e Bracketing/flash	
e1 Flash shutter speed	185
e2 Flash cntrl for built-in flash	185
e3 Modeling flash	191
e4 Auto bracketing set	191
e5 Auto FP	195
e6 Bracketing order	195
f Controls	
f1  switch	196
f2 OK button (shooting mode)	196
f3 Assign FUNC. button	197
f4 Assign AE-L/AF-L button	200
f5 Customize command dials	201
f6 No memory card?	201
f7 Reverse indicators	201

Ⓡ: Reset Custom Settings








Choose whether to restore default settings for the current Custom Settings. See page 260 for a list of default settings. Custom Settings are not reset when a two-button reset is performed.

Option	Description
Yes	Restore defaults for the current Custom Settings (pg. 260).
No	Exit without changing Custom Settings.

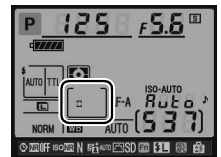
a: Autofocus

a1: AF-area Mode

This option (available in all shooting modes) determines how the focus point for autofocus is selected. Choose from the following options:

Option	Description
 Single point	User selects focus point using multi selector; camera focuses on subject in selected focus point only. Use with stationary subjects. Default setting for  mode.
 Dynamic area	In AF-A and AF-C autofocus modes , user selects focus point manually, but camera will focus based on information from surrounding focus points if subject briefly leaves selected point. Use with erratically moving subjects. In AF-S autofocus mode , user selects focus point manually; camera focuses on subject in selected focus point only. Default for  mode.
 Auto-area	Camera automatically detects subject and selects focus point. If type G or D lens is used, camera can distinguish human subjects from background for improved subject detection. Default for  mode.
 3D-tracking (11 points)	In AF-A and AF-C autofocus modes , user selects focus point using multi selector. If user changes composition after focusing, camera uses 3D-tracking to select new focus point and keep focus locked on original subject while shutter-release button is pressed halfway. Use to recompose photographs while shooting relatively static subjects. If subject leaves viewfinder, remove your finger from shutter-release button and recompose photograph with subject in selected focus point. In AF-S autofocus mode , user selects focus point manually; camera focuses on subject in selected focus point only.

The current setting is shown in the shooting information display (pg. 10).



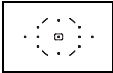
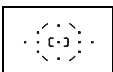
3D-tracking (11 Points)

When the shutter-release button is pressed halfway, the colors in the area surrounding the focus point are stored in the camera. Consequently 3D-tracking may not produce the desired results with subjects that are the same color as the background.





a2: Center Focus Point

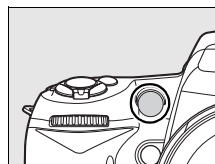
This option (available in all shooting modes) determines the size of the center focus point.

Option	Viewfinder display	Description
[CF] Normal zone (default)		Focus on stationary subjects that can be easily framed in the focus point.
[CF] Wide zone		Focus on moving subjects. Not available when Auto-area is selected for Custom Setting a1 (AF-area mode).

See page 54 for more information on focus settings.

a3: Built-in AF-assist Illuminator

Choose whether the built-in AF-assist illuminator lights to assist the focus operation when lighting is poor. This option is available in all shooting modes except  and .



Option	Description
On (default)	If the subject is poorly lit, the AF-assist illuminator will light to assist the focus operation in single-servo AF (AF-S selected for autofocus mode, or single-servo AF selected in AF-A autofocus mode) when Single point , Auto-area , or 3D-tracking (11 points) is selected for Custom Setting a1 (AF-area mode) or when Custom Setting a1 is set to Dynamic area and the center focus point is selected.
Off	The AF-assist illuminator does not light to assist the focus operation. The camera may not be able to focus using autofocus when lighting is poor.

The AF-Assist Illuminator

The AF-assist illuminator has a range of about 0.5–3.0 m (1 ft. 8 in.–9 ft. 10 in.); when using the illuminator, use a lens with a focal length of 24–200 mm and remove the lens hood.

See Also

See page 231 for restrictions on the lenses that can be used with AF assist.

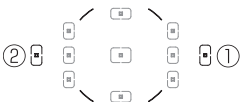
a4: AF Point Illumination

Choose whether the active focus point is highlighted in red in the viewfinder. This option is available in all shooting modes.

Option	Description
Auto (default)	The selected focus point is automatically highlighted as needed to establish contrast with the background.
On	The selected focus point is always highlighted, regardless of the brightness of the background. Depending on the brightness of the background, the selected focus point may be difficult to see.
Off	The selected focus point is not highlighted.

a5: Focus Point Wrap-Around

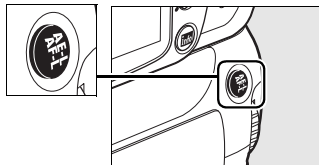
Choose whether focus-point selection “wraps around” from one edge of the viewfinder to another. This option is available in all shooting modes.

Option	Description
Wrap	Focus-point selection “wraps around” from top to bottom, bottom to top, right to left, and left to right, so that, for example, pressing ► when a focus point at the right edge of the viewfinder display is highlighted (①) selects the corresponding focus point at the left edge of the display (②). 
No wrap (default)	The focus-area display is bounded by the outermost focus points so that, for example, pressing ► when a focus point at the right edge of the display is selected has no effect.



a6: AE-L/AF-L for MB-D80

Choose the function assigned to the AE-L/AF-L button on the optional MB-D80 battery pack. This option is available in all shooting modes.



Option	Description
AE/AF lock* (default)	Focus and exposure lock while the MB-D80 AE-L/AF-L button is pressed.
AE lock only*	Exposure locks while the MB-D80 AE-L/AF-L button is pressed.
AF lock only*	Focus locks while the MB-D80 AE-L/AF-L button is pressed.
AE lock (Hold)	Exposure locks when the MB-D80 AE-L/AF-L button is pressed, and remains locked until the button is pressed a second time or the exposure meters turn off.
AF-ON*	Pressing the MB-D80 AE-L/AF-L button initiates autofocus.
FV lock	Flash value for the built-in flash and optional SB-900, SB-800, SB-600, SB-400, and SB-R200 flash units locks when the MB-D80 AE-L/AF-L button is pressed (pg. 198), and remains locked until the button is pressed a second time or the exposure meters turn off.
^[1] Focus point selection	The focus point (pg. 56) can be selected by pressing the MB-D80 AE-L/AF-L button and rotating the sub-command dial.

* Pressing when these options are highlighted displays a **Focus point selection** sub-menu. If **On** is selected, the focus point can be chosen by pressing the MB-D80 AE-L/AF-L button and rotating the sub-command dial.

a7: Live View Autofocus

This option (available in all shooting modes) determines how the focus point for autofocus is selected in live view. Choose from the following options:

Mode	Description
Face priority	The camera automatically detects and focuses on portrait subjects facing camera. Use for portraits; default for and modes.
Wide area (default)	Use for hand-held shots of landscapes and other non-portrait subjects. The focus point can be selected manually. Default for modes.
Normal area	Use for pin-point focus on a selected spot in the frame. A tripod is recommended. Default setting for mode.


b: Metering/Exposure


b1: EV Steps for Exposure Cntrl.

This option (available in all shooting modes) determines whether adjustments to shutter speed, aperture, exposure compensation, flash compensation, and bracketing are made in increments equivalent to $\frac{1}{3}$ EV or $\frac{1}{2}$ EV.

Option	Description
$\frac{1}{3}$ 1/3 step (default)	Changes to shutter speed, aperture, exposure compensation, and flash compensation are in increments equivalent to $\frac{1}{3}$ EV. The bracketing increment can be selected from $\frac{1}{3}$, $\frac{2}{3}$, and 1 EV.
$\frac{1}{2}$ 1/2 step	Changes to shutter speed, aperture, exposure compensation, and flash compensation are in increments equivalent to $\frac{1}{2}$ EV. The bracketing increment can be selected from $\frac{1}{2}$ and 1 EV.

b2: Easy Exposure Compensation

This option (available in **P**, **S**, **A**, and **M** modes) controls whether the  button is needed to set exposure compensation (pg. 90). If **On** is selected, the 0 at the center of the exposure display will blink even when exposure compensation is set to ± 0 .

Option	Description
On	Exposure compensation can be set by rotating one of the command dials (see note below). Selected value does not change when exposure meters turn off, camera is turned off, or Off is selected for Custom Setting b2.
Off (default)	Exposure compensation is set by pressing the  button and rotating the main command dial.

Change Main/Sub

The dial used to set exposure compensation when **On** is selected for Custom Setting b2 (**Easy exposure compensation**) depends on the option selected for Custom Setting f5 (**Customize command dials**) > **Change main/sub** (pg. 201).

		Customize command dials > Change main/sub	
		Off (default)	On
Exposure mode	P	Sub-command dial	Sub-command dial
	S	Sub-command dial	Main command dial
	A	Main command dial	Sub-command dial
	M	N/A	

b3: Center-Weighted Area


When calculating exposure, center-weighted metering assigns the greatest weight to a circle in the center of the frame. The diameter (ϕ) of this circle can be set to 6, 8, or 10 mm. This option is available in **P**, **S**, **A**, and **M** modes only.

Option	
(◀) 6 ϕ	6 mm
(◀) 8 ϕ	8 mm (default)
(◀) 10 ϕ	10 mm

b4: Fine Tune Optimal Exposure

Use this option (available in all shooting modes) to fine-tune the exposure value selected by the camera. Exposure can be fine tuned separately for each metering method by from +1 to -1 EV in steps of $1/6$ EV.

Fine-Tuning Exposure

Exposure can be fine-tuned separately for each Custom Settings bank and is not affected by two-button resets. Note that as the exposure compensation () icon is not displayed, the only way to determine how much exposure has been altered is to view the amount in the fine-tuning menu. Exposure compensation (pg. 90) is preferred in most situations.



c: Timers/AE Lock










c1: Shutter-Release Button AE-L

At the default setting of **Off**, exposure only locks when the **AE-L/AF-L** button is pressed. If **On** is selected, exposure will also lock when the shutter-release button is pressed halfway. This option is available in all shooting modes.


c2: Auto Meter-off Delay





This option (available in all shooting modes) controls how long the camera continues to meter exposure when no operations are performed. Choose from 4 s, 6 s, 8 s, 16 s, 30 s, 1 minute, 5 minutes, 10 minutes, or 30 minutes. The shutter-speed and aperture displays in the control panel and viewfinder turn off automatically when the exposure meters turn off.

Choose a shorter meter-off delay for longer battery life. When the camera is powered by an optional EH-5a or EH-5 AC adapter, the exposure meters will not turn off automatically.

Option	
 4s	4 s
 6s	6 s (default)
 8s	8 s
 16s	16 s
 30s	30 s
 1m	1 min.
 5m	5 min.
 10m	10 min.
 30m	30 min.

c3: Self-Timer

This option (available in all shooting modes) controls the length of the shutter release delay (**Self-timer delay**; see right) and the number of shots (**Number of shots**; choose a value from 1–9) taken each time the shutter-release button is pressed in self-timer mode (at values other than 1, pictures will be taken at the rate selected for  L mode; pg. 182).

Self-timer delay	
 2s	2 s
 5s	5 s
 10s	10 s (default)
 20s	20 s



c4: Monitor off Delay

This option (available in all shooting modes) controls how long the monitor remains on when no operations are performed during playback, image review, or when menus or shooting information is displayed. Choose from 4 s (the default for image review), 10 s (the default for playback and shooting information), 20 s (the default for menus), 1 minute, 5 minutes, or 10 minutes. Choose a shorter monitor-off delay for longer battery life. Regardless of the setting chosen, the monitor remains on if no operations are performed for about ten minutes when the camera is powered by an optional EH-5a or EH-5 AC adapter.

Option	
4s	4 s
10s	10 s
20s	20 s
1m	1 min.
5m	5 min.
10m	10 min.

c5: Remote on Duration

Choose how long the camera will wait for a signal from the remote before cancelling delayed or quick-response remote modes (pg. 68). Choose shorter times for longer battery life. The default setting is one minute.



Option	
1m	1 min. (default)
5m	5 min.
10m	10 min.
15m	15 min.

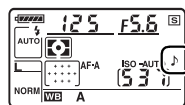
This option is available in all shooting modes.

d: Shooting/Display

d1: Beep

At the default setting of **On**, a beep will sound when the camera focuses in single-servo AF (**AF-S** or when shooting stationary subjects in **AF-A** autofocus mode), while the release timer is counting down in self-timer and delayed remote modes (pg. 66, 68), or when a photograph is taken in quick-response remote mode (pg. 68). The beep will not sound when **Off** is selected.

This option is available in all shooting modes. The current setting is shown in the control panel:  is displayed when the beep is on,  when it is off.



d2: Viewfinder Grid Display

Choose **On** to display on-demand grid lines in the viewfinder for reference when composing photographs. The default setting is **Off**. This option is available in all shooting modes.




d3: ISO Display and Adjustment

Choose **Show ISO sensitivity (ISO)** or **Show ISO/Easy ISO (ISO $\frac{S}{M}$)** to display the current ISO sensitivity setting in the frame count displays in the control panel and viewfinder. If **Show ISO/Easy ISO (ISO $\frac{S}{M}$)** is selected, ISO sensitivity can be set by rotating the sub-command dial (modes **P** and **S**) or main command dial (mode **A**). Choose **Show frame count** (the default setting) to show the number of exposures remaining in the frame count displays.

This option is available in all shooting modes.

d4: Viewfinder Warning Display

Choose **On** (the default setting) to display the following warnings in the viewfinder:

Icon	Description
	Displayed when a monochrome Picture Control is selected.
	Displayed when the battery is low.
	Displayed when no memory card is inserted.


These warnings are not displayed if **Off** is selected. This option is available in all shooting modes.



d5: Screen Tips

Choose **On** (the default setting) to display tips for items selected in the shooting information display, **Off** to turn tip display off. This option is available in all shooting modes.

d6: CL Mode Shooting Speed

This option (available in all shooting modes) determines the maximum frame advance rate in  (continuous low speed) release mode. Choose from values between one and four frames per second (fps); the default setting is 3 fps. Note that the frame advance rate may drop below the selected value at slow shutter speeds.

d7: File Number Sequence

When a photograph is taken, the camera names the file by adding one to the last file number used. This option (available in all shooting modes) controls whether file numbering continues from the last number used when a new folder is created, the memory card is formatted, or a new memory card is inserted in the camera.

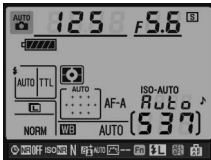
Option	Description
On	When a new folder is created, the memory card formatted, or a new memory card inserted in the camera, file numbering continues from the last number used or from the largest file number in the current folder, whichever is higher. If a photograph is taken when the current folder contains a photograph numbered 9999, a new folder will be created automatically and file numbering will begin again from 0001.
Off (default)	File numbering is reset to 0001 when a new folder is created, the memory card is formatted, or a new memory card is inserted in the camera. Note that a new folder is created automatically if a photograph is taken when the current folder contains 999 photographs.
RESET Reset	Same as for On , except that the next photograph taken is assigned a file number by adding one to the largest file number in the current folder. If the folder is empty, file numbering is reset to 0001.

File Number Sequence

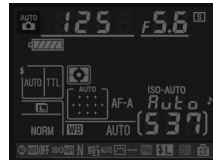
If the current folder is numbered 999 and contains either 999 photographs or a photograph numbered 9999, the shutter-release button will be disabled and no further photographs can be taken. Choose **Reset** for Custom Setting d7 (**File number sequence**) and then either format the current memory card or insert a new memory card.

d8: Shooting Info Display

At the default setting of **AUTO Auto**, the color of the lettering in the information display (pg. 10) will automatically change from black to white or white to black in response to ambient lighting conditions. To always use the same color lettering, select **Manual** and choose **B Dark on light** (black lettering) or **W Light on dark** (white lettering). Monitor brightness will automatically be adjusted for maximum contrast with the selected text color.



Dark on light



Light on dark

This option is available in all shooting modes.

d9: LCD Illumination

At the default setting of **Off**, the control panel backlight (LCD illuminator) will only light while the power switch is in the **⚡** position. If **On** is selected, the control panel will be illuminated while the exposure meters are active (pg. 35). Select **Off** for increased battery life.

This option is available in all shooting modes.

d10: Exposure Delay Mode

At the default setting of **Off**, shutter is released when the shutter-release button is pressed. In situations where the slightest camera movement can blur pictures, **On** can be selected to delay shutter release until about 1 s after the shutter-release button is pressed and the mirror is raised. This option is available in all shooting modes.





d11: Flash Warning

In **P**, **S**, **A**, and **M** modes, the flash must be raised manually before use. If **On** (the default setting) is selected for this option and lighting is poor, the flash-ready light (⚡) will flicker in the viewfinder when the shutter-release button is pressed halfway to warn that the built-in flash is required. No warning will be displayed if **Off** is selected. This option is available in **P**, **S**, **A**, and **M** modes only.








d12: MB-D80 Battery Type

To ensure that the camera functions as expected when AA batteries are used in the optional MB-D80 battery pack, match the option selected in this menu (available in all shooting modes) to the type of batteries inserted in the battery pack. There is no need to adjust this option when using EN-EL3e batteries.

Option	Description
 LR6 (AA alkaline) (default)	Select when using LR6 alkaline AA batteries.
 HR6 (AA Ni-MH)	Select when using HR6 Ni-MH AA batteries.
 FR6 (AA lithium)	Select when using FR6 lithium AA batteries.
 ZR6 (AA Ni-Mn)	Select when using ZR6 Ni-Mn AA batteries.

Using AA Batteries

EN-EL3e rechargeable Li-ion batteries are recommended for best performance. Fewer pictures can be taken with AA batteries (pg. 275). The capacity of AA batteries drops sharply at temperatures below 20 °C (68 °F) and varies with make and storage conditions; in some cases, batteries may cease to function before their expiry date. Some AA batteries can not be used; due to their performance characteristics and limited capacity, alkaline and nickel-manganese batteries should only be used if no alternative is available and then only at warmer temperatures. The camera shows the level of AA batteries as follows:



Control panel	Viewfinder	Description
	—	Batteries fully charged.
		Low battery. Ready fresh batteries.
 (blinks)	 (blinks)	Battery exhausted; shutter release disabled. Change batteries.

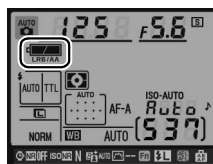
Battery level for EN-EL3e rechargeable Li-ion batteries is displayed normally.

The MB-D80 Battery Pack

The MB-D80 takes one or two EN-EL3e rechargeable Li-ion battery or six AA alkaline, Ni-MH, lithium, or nickel manganese batteries (an EN-EL3e is supplied with the camera). Higher frame rates are available with AA batteries; note, however, that in the case of AA batteries the frame rate will decrease as battery level drops.

The shooting information display shows the type of battery inserted in the MB-D80 as follows:

MB-D80 battery type display	Battery type
	EN-EL3e rechargeable Li-ion battery
	AA batteries



e: Bracketing/Flash

e1: Flash Shutter Speed

This option (available only in **P** and **A** modes) determines the slowest shutter speed available when using front- or rear-curtain sync or red-eye reduction in modes **P** and **A** (regardless of the setting chosen, shutter speeds can be as slow as 30 s in modes **S** and **M** or at flash settings of slow sync, slow rear-curtain sync, or red-eye reduction with slow sync). Options range from $1/60$ s (**1/60 s**, the default setting) to 30 s (**30 s**).

e2: Flash Cntrl for Built-in Flash

Choose the flash mode for the built-in flash. This option is available in **P**, **S**, **A**, and **M** modes only.

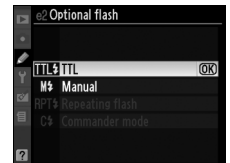
Option	Description
TTL ↕ TTL (default)	Flash output is adjusted automatically in response to shooting conditions.
M ↕ Manual	Choose the flash level (pg. 187).
RPT ↕ Repeating flash	The flash fires repeatedly while the shutter is open, producing a strobe-light effect (pg. 187).
C ↕ Commander mode	Use the built-in flash as a master flash controlling one or more remote optional flash units (pg. 188).

"Manual" and "Repeating Flash"

 icons blink in the control panel and viewfinder when these options are selected.
















The SB-400

When an optional SB-400 flash unit is attached and turned on, Custom Setting e2 changes to **Optional flash**, allowing the flash control mode for the SB-400 to be selected from **TTL** and **Manual (Repeating flash)** and **Commander mode** options are not available.



Flash Control Mode

The shooting information display shows the flash control mode for the built-in flash (**Built-in**) and for optional flash units attached to the camera accessory shoe (**Optional**) as follows:

	i-TTL		Auto aperture (AA) ¹		Manual	
	Built-in	Optional	Built-in	Optional	Built-in	Optional
TTL ²			—			
Auto FP (pg. 195)	—		—		—	
Repeating flash ²	—	—	—	—		
Commander mode ²			—			

1 Available with SB-900 and SB-800 only.

2 Flash control mode for built-in flash can be selected using Custom Setting e2 (**Flash Control for Built-in Flash**, pg. 185).

See Also

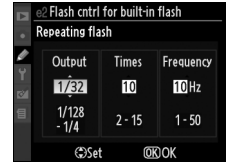
See Custom Setting e5 (**Auto FP**, pg. 195) for information on flash sync speeds as fast as $1/320$ s.

Manual

Choose a flash level between **Full** and **1/128** ($1/128$ of full power). At full power, the built-in flash has a Guide Number of 18/59 (m/ft., ISO 200, 20°C/68°F).

Repeating Flash

The flash fires repeatedly while the shutter is open, producing a strobe-light effect. Press ◀ or ▶ to highlight the following options, ▲ or ▼ to change.



Option	Description
Output	Choose flash output (expressed as a fraction of full power).
Times	Choose the number of times the flash fires at the selected output. Note that depending on shutter speed and the option selected for Frequency , the actual number of flashes may be less than selected.
Frequency	Choose how often the flash fires per second.

“Times”

The options available for **Times** are determined by flash output.

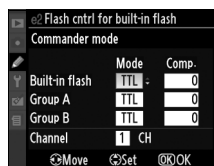
Output	Options available for Times
1/4	2
1/8	2–5
1/16	2–10
1/32	2–10, 15
1/64	2–10, 15, 20, 25
1/128	2–10, 15, 20, 25, 30, 35



Commander Mode

Use the built-in flash as a master flash controlling one or more remote optional SB-900, SB-800, SB-600, or SB-R200 flash units in up to two groups (A and B) using advanced wireless lighting.

Selecting this option displays the menu shown at right. Press ◀ or ▶ to highlight the following options, ▲ or ▼ to change.

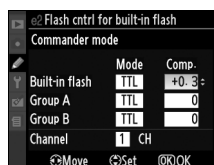


Option	Description
Built-in flash	Choose a flash mode for the built-in flash (commander flash).
TTL	i-TTL mode. Choose flash compensation from values between +3.0 and -3.0 EV in increments of 1/3 EV.
M	Choose the flash level from values between Full and 1/128 (1/128 of full power).
--	The built-in flash does not fire, but the AF-assist illuminator lights. The built-in flash must be raised so that it can emit monitor pre-flashes.
Group A	Choose a flash mode for all flash units in group A.
TTL	i-TTL mode. Choose flash compensation from values between +3.0 and -3.0 EV in increments of 1/3 EV.
AA	Auto aperture (available only with SB-900 and SB-800 flash units). Choose flash compensation from values between +3.0 and -3.0 EV in increments of 1/3 EV.
M	Choose the flash level from values between Full and 1/128 (1/128 of full power).
--	The flash units in this group do not fire.
Group B	Choose a flash mode for all flash units in group B. The options available are the same as those listed for Group A , above.
Channel	Choose from channels 1–4. All flash units in both groups must be set to the same channel.

Follow the steps below to take photographs in commander mode.

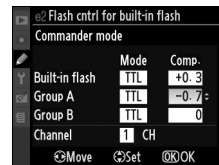
1 Adjust settings for the built-in flash.

Choose the flash control mode and output level for the built-in flash. Note that output level can not be adjusted in -- mode.



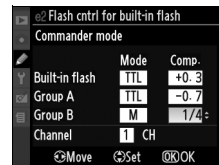
2 Adjust settings for group A.

Choose the flash control mode and output level for the flash units in group A.

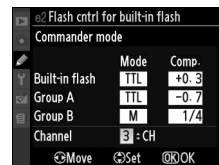


3 Adjust settings for group B.

Choose the flash control mode and output level for the flash units in group B.



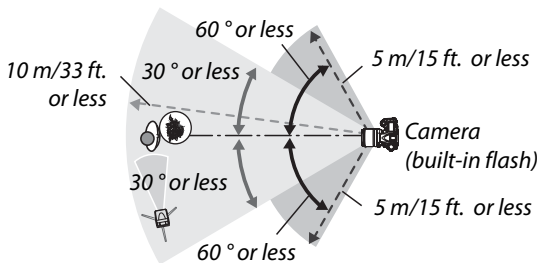
4 Select the channel.



5 Press **OK**.

6 Compose the shot.

Compose the shot and arrange the flash units as shown below. Note that the maximum distance at which the remote flash units can be placed may vary with shooting conditions.




Wireless remote sensors on flash units should face camera.

7 Set the remote flash units to the selected channel.

Turn all the remote flash units on and set them to the channel selected in Step 4. See the Speedlight instruction manuals for details.

8 Raise the built-in flash.

Press the  button to raise the built-in flash. Note that even if -- is selected for **Built-in flash > Mode**, the built-in flash must be raised so that monitor preflashes will be emitted.

9 Frame the photograph, focus, and shoot.


After confirming that the camera flash-ready light and the flash-ready lights for all other flash units are lit, frame the photograph, focus, and shoot. FV lock (pg. 198) can be used if desired.

Commander Mode





Position the sensor windows on the remote flash units to pick up the monitor preflashes from the built-in flash (particular care is required when not using a tripod). Be sure that direct light or strong reflections from the remote flash units do not enter the camera lens (in TTL mode) or the photocells on the remote flash units (AA mode), as this may interfere with exposure. To prevent timing flashes emitted by the built-in flash from appearing in photographs taken at short range, choose low ISO sensitivities or small apertures (large f-numbers) or use an optional SG-3IR infrared panel for the built-in flash. An SG-3IR is required for best results with rear-curtain sync, which produces brighter timing flashes. After positioning the remote flash units, take a test shot and view the results in the camera monitor.

Although there is no limit on the number of remote flash units that may be used, the practical maximum is three. With more than this number, the light emitted by the remote flash units will interfere with performance.

The Flash Mode Display

 does not appear in the control panel flash mode display when -- is selected for **Built-in flash > Mode**.

Flash Compensation

The flash compensation value selected with the  () button and sub-command dial is added to the flash compensation values selected for the built-in flash, group A, and group B in the **Commander mode** menu. A  icon is displayed in the control panel and viewfinder when a flash compensation value other than ± 0 is selected for **Built-in flash > TTL**. The  icon flashes when **M** is selected for **Built-in flash**.

e3: Modeling Flash

If **On** is selected when the camera is being used with the built-in flash or an optional SB-900, SB-800, SB-600, or SB-R200 flash unit, a modeling flash will be emitted when the camera depth-of-field preview button is pressed (pg. 82). The default setting is **Off**. This option is available in **P**, **S**, **A**, and **M** modes only.

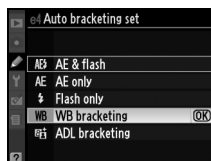
e4: Auto Bracketing Set

Choose the setting or settings bracketed when auto bracketing is in effect (**P**, **S**, **A**, and **M** modes only). Choose **AE & flash** (**AE**; the default setting) to perform both exposure and flash-level bracketing (pg. 92), **AE only** (**AE**) to bracket only exposure, **Flash only** (**⚡**) to perform only flash-level bracketing, **WB bracketing** (**WB**) to perform white-balance bracketing (see below), or **ADL bracketing** to take one picture with Active D-Lighting on and another with Active D-Lighting off (pg. 193).

■ White Balance Bracketing

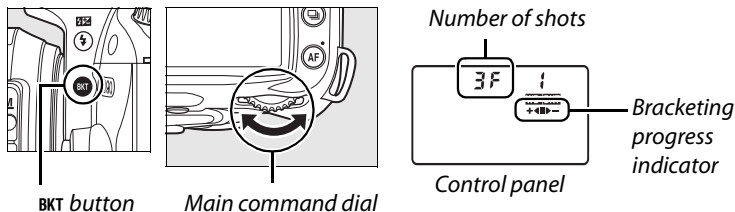
1 Select white balance bracketing.

Choose **WB bracketing** for Custom Setting e4 (**Auto bracketing set**). Note that white balance bracketing is not available at image quality settings of NEF (RAW) or NEF (RAW) + JPEG.



2 Choose the number of shots.

Pressing the **BKT** button, rotate the main command dial to choose the number of shots in the bracketing sequence. The number of shots is shown in the control panel.

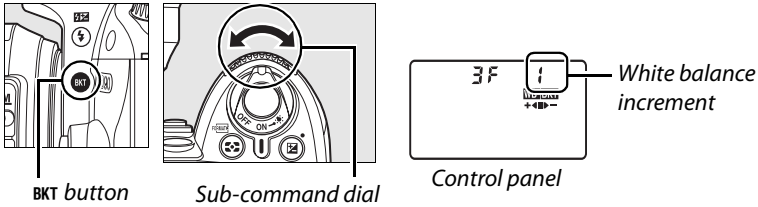


Viewfinder

At settings other than zero, a **WB-BKT** icon and bracketing progress indicator appear in the control panel.

3 Select a white balance increment.

Pressing the **BKT** button, rotate the sub-command dial to choose the white balance adjustment. Each increment is roughly equivalent to 5 mired.



Choose from increments of 1 (5 mired), 2 (10 mired), or 3 (15 mired; for a definition of mired, see page 98). Higher **B** values correspond to increased amounts of blue, higher **A** values to increased amounts of amber (pg. 97). The bracketing programs with an increment of 1 are listed below.

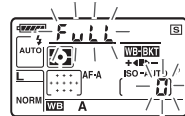
Control panel display	No. of shots	White balance increment	Bracketing order (EVs)
0F 1	0	1	0
b2F 1 +◀■	2	1 B	0 / 1 B
A2F 1 ■▶-	2	1 A	0 / 1 A
3F 1 +◀■▶-	3	1 A, 1 B	0 / 1 A / 1 B

4 Frame a photograph, focus, and shoot.

Each shot will be processed to create the number of copies specified in the bracketing program, and each copy will have a different white balance. Modifications to white balance are added to the white balance adjustment made with white balance fine-tuning.



If the number of shots in the bracketing program is greater than the number of exposures remaining, the exposure count displays in the control panel and viewfinder will flash and the shutter release will be disabled. Shooting can begin when a new memory card is inserted.



■ ■ Canceling Bracketing

To cancel bracketing, press the **BKT** button and rotate the main command dial until the number of shots in the bracketing sequence is zero (**0 F**) and **WB:BKT** is no longer displayed in the control panel. The program last in effect will be restored the next time bracketing is activated. Bracketing can also be cancelled by performing a two-button reset (pg. 75), although in this case the bracketing program will not be restored the next time bracketing is activated.

■ White Balance Bracketing

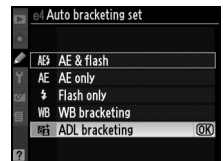
White balance bracketing affects only color temperature (the amber-blue axis in the white balance fine-tuning display, pg. 97). No adjustments are made on the green-magenta axis.

If the camera is turned off while the memory card access lamp is lit, the camera will power off only after all photographs in the sequence have been recorded.

■ ■ ADL Bracketing

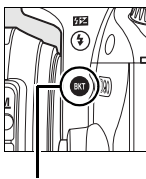
1 Select ADL bracketing.

Choose **ADL bracketing** for Custom Setting e4 (**Auto bracketing set**).

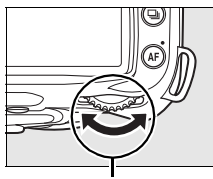


2 Enable bracketing.

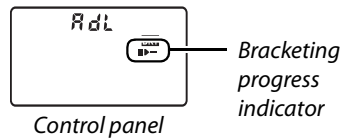
Pressing the **BKT** button, rotate the main command dial until the bracketing progress indicator is displayed in the control panel.



BKT button



Main command dial



Control panel



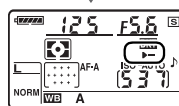
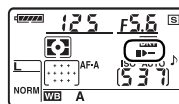
Viewfinder



3 Frame a photograph, focus, and shoot.

The camera will vary Active D-Lighting with each shot. The first shot will be taken with Active D-Lighting off, the following shot at the value currently selected for Active D-Lighting in the shooting menu (pg. 165).

While bracketing is in effect, a bracketing progress indicator will be displayed in the control panel. The ■ segment will disappear from the indicator when the unmodified shot is taken, the ► indicator when the shot with Active D-Lighting is taken.



■ ■ Canceling Bracketing

To cancel bracketing, press the **BKT** button and rotate the main command dial until the bracketing progress indicator is no longer displayed in the control panel.

■ ✓ Active D-Lighting

Matrix metering (☉, pg. 87) is recommended. Noise, lines, and distortion may appear in photographs taken with Active D-Lighting at high ISO sensitivities. The **Brightness** and **Contrast** Picture Control settings (pg. 111) can not be adjusted while active D-Lighting is in effect. In exposure mode **M**, an Active D-Lighting setting of **Auto** is equivalent to **Normal**.



e5: Auto FP

Selecting **On** for this option (available in only **P**, **S**, **A**, and **M** modes) enables Auto FP High-Speed Sync with optional flash units that support the Nikon Creative Lighting System (CLS). Auto FP allows the flash to be used at shutter speeds $1/200$ s– $1/4000$ s. Choose to enable fill flash when taking portraits under bright light or when taking photographs at large apertures. Auto FP High-Speed Sync is not available when using the built-in flash. The default setting is **Off**.


e6: Bracketing Order





At the default setting of **MTR>under>over** (☒), exposure and flash bracketing are performed in the order described on pages 92 and 264, white balance bracketing in the order no modification, **A**, **B** (pg. 191). If **Under>MTR>over** (->+) is selected, exposure and flash bracketing will proceed in order from the lowest to the highest value, white balance bracketing in the order **A**, no modification, **B**. This option is available in **P**, **S**, **A**, and **M** modes only.




f: Controls




f1: Switch

Choose the function performed by rotating the power switch to the  position. This option is available in all shooting modes.

Option	Description
 LCD backlight () (default)	Control panel backlight illuminates for 6 s.
  Both	Control panel backlight illuminates and shooting information is displayed in monitor.

f2: OK Button (Shooting Mode)

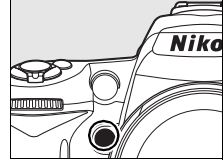
This option (available in all shooting modes) determines what operations can be performed by pressing the  button in shooting mode.











Option	Description
Select center focus point (default)	Pressing the  button in shooting mode selects the center focus point.
Highlight active focus point	Pressing the  button in shooting mode highlights the active focus point.
Not used	Pressing the  button has no effect when the camera is in shooting mode.



f3: Assign FUNC. Button

Choose the role played by the **Fn** button. This option is available in all shooting modes.



Option	Description
 Framing grid	Press the Fn button and rotate the main command dial to turn the grid display in the viewfinder on or off (pg. 9).
 AF-area mode	Press the Fn button and rotate the main command dial to select the AF-area mode (pg. 173).
 Center focus point	Press the Fn button and rotate the main command dial to choose between normal and wide center focus points (pg. 174).
 FV lock (default)	Press the Fn button to lock flash value (built-in flash and SB-900, SB-800, SB-600, SB-400, and SB-R200 flash units only, see below). Press again to cancel FV lock.
 Flash off	The built-in flash and optional flash units turn off while the Fn button is pressed.
 Matrix metering	Matrix metering is activated while the Fn button is pressed.
 Center-weighted metering	Center-weighted metering is activated while the Fn button is pressed.
 Spot metering	Spot metering is activated while the Fn button is pressed.
 Access top item in MY MENU	Press the Fn button to jump to the top item in “MY MENU.” Select this option for quick access to a frequently-used menu item.
 +RAW +NEF (RAW)	If image quality is set to JPEG fine , JPEG normal , or JPEG basic , “RAW” will be displayed in the control panel and an NEF (RAW) copy will be recorded with the next picture taken after the Fn button is pressed. To exit without recording an NEF (RAW) copy, press the Fn button again or turn the camera off.



■ FV Lock

This feature is used to lock flash output, preventing the flash level from changing between shots or while recomposing photographs. Flash output is adjusted automatically for any changes in ISO sensitivity or aperture.

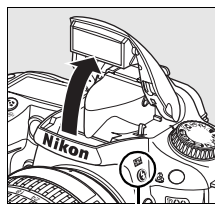
1 Assign FV lock to the Fn button.

Both the **Fn** and the **AE-L/AF-L** button can be used for FV lock. To use the **Fn** button as described below, select **FV lock** for Custom Setting f3 (**Assign FUNC. button**). To use the **AE-L/AF-L** button, choose **FV lock** for Custom Setting f4 (**Assign AE-L/AF-L button**, pg. 200).



2 Raise the flash.

In **AUTO**, **S&L**, **SL**, and **SL** modes, the flash will pop up automatically as required when the shutter-release button is pressed halfway. In **P**, **S**, **A**, and **M** modes, press the **⚡** button to raise the flash.



⚡ button

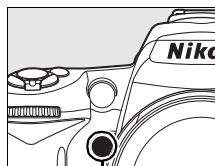
3 Focus.

Position the subject in the center of the frame and press the shutter-release button halfway to focus.



4 Lock flash level.

After confirming that the flash-ready indicator (⚡) is displayed in the viewfinder, press the **Fn** button. The flash will emit a monitor preflash to determine the appropriate flash level. Flash output will be locked at this level and a FV lock icon (FVL) will appear in the viewfinder.



Fn button




5 Recompose the photograph.



6 Take the photograph.

Press the shutter-release button the rest of the way down to shoot. If desired, additional pictures can be taken without releasing FV lock.

7 Release FV lock.

Press the **Fn** button to release FV lock and confirm that the  icon is no longer displayed in viewfinder.

Using FV Lock with the Built-in Flash

When the built-in flash is used alone, FV lock is only available if **TTL** (the default setting) is selected for Custom Setting e2 (**Flash cntrl for built-in flash**; pg. 185).

Using FV Lock with Optional Flash Units

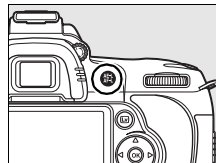
In addition to the built-in flash, FV lock is available with SB-900, SB-800, SB-600, SB-400 and SB-R200 flash units (available separately). Set the optional flash to TTL mode (the SB-900 and SB-800 can also be used in AA mode; see the flash manual for details). While FV lock is in effect, flash output will automatically be adjusted for changes in flash zoom head position.







When **Commander mode** is selected for Custom Setting e2 (**Flash cntrl for built-in flash**, pg. 185), FV lock can be used with remote SB-900, SB-800, SB-600, or SB-R200 flash units if (a) any of the built-in flash, flash group A, or flash group B is in TTL mode, or (b) a flash group is composed entirely of SB-900 and SB-800 flash units in TTL or AA mode.



f4: Assign AE-L/AF-L Button

Choose the role played by the **AE-L/AF-L** button. This option is available in all shooting modes.



Option	Description
 AE/AF lock (default)	Focus and exposure lock while the AE-L/AF-L button is pressed.
 AE lock only	Exposure locks while the AE-L/AF-L button is pressed.
 AF lock only	Focus locks while the AE-L/AF-L button is pressed.
 AE lock (hold)	Exposure locks when the AE-L/AF-L button is pressed, and remains locked until the button is pressed a second time or the exposure meters turn off.
 AF-ON	The AE-L/AF-L button initiates autofocus. The shutter-release button can not be used to focus.
 FV lock	Press the AE-L/AF-L button to lock flash value (built-in flash and SB-900, SB-800, SB-600, SB-400, and SB-R200 flash units only, pg. 198). Press again to cancel FV lock.

f5: Customize Command Dials

This option (available in all shooting modes) controls the operation of the main and sub-command dials.



Option	Description
Reverse rotation	Controls the direction of the command dials. Choose No (the default option) for normal command dial operation, or Yes to reverse the rotation of the command dials. This setting also applies to the command dials for the MB-D80.
Change main/sub	At the default setting of Off , the main command dial controls shutter speed and the sub-command dial controls aperture. If On is selected, the main command dial will control aperture and the sub-command dial shutter speed. This setting also applies to the command dials for the MB-D80.
Menus and playback	At the default setting of On , the main command dial can be used to choose the picture displayed during full-frame playback, move the cursor left or right during thumbnail playback, and move the menu highlight bar up or down. The sub-command dial is used to display additional photo information in full-frame playback and to move the cursor up or down during thumbnail playback. While menus are displayed, rotating the sub-command dial right displays the sub-menu for the selected option, while rotating it left displays the previous menu. To make a selection, press ▶ or ⓧ . On (image review excluded) is the same as On except that the command dials can not be used during image review. If Off is selected, the multi selector is used to choose the picture displayed during full-frame playback, highlight thumbnails, and navigate menus.

f6: No Memory Card?

If **Release locked** (the default setting) is selected, the shutter-release button is only enabled when a memory card is inserted in the camera. Selecting **Enable release** allows the shutter to be released when no memory card is inserted, although no pictures will be recorded (they will however be displayed in the monitor in demo mode). Note that when photographs are being captured to a computer using Camera Control Pro 2 (available separately), photographs are not recorded to the camera memory card and the shutter will be enabled regardless of the setting chosen for this option. This option is available in all shooting modes.



f7: Reverse Indicators

At the default setting of  (+0-), the exposure indicators in the viewfinder and shooting information display are displayed with positive values on the left and negative values on the right. Select  (-0+) to display negative values on the left and positive values on the right. This option is available in all shooting modes.

Y The Setup Menu: Camera Setup

The setup menu contains the options listed below. To display the setup menu, press MENU and press ◀ to highlight the tab for current menu, then press ▲ or ▼ to highlight the setup menu tab; for more information, see page 19.

Option	See page	Option	See page
Format memory card	202	Image comment	205
LCD brightness	202	Auto image rotation	205
Clean image sensor	244	Image dust off ref photo	206
Lock mirror up for cleaning ¹	246	Battery info	208
Video mode	203	GPS	208
HDMI	203	Eye-Fi upload ²	208
World time	204	Firmware version	208
Language	204		

1 Not available when battery is low.

2 Only available when compatible Eye-Fi memory card is inserted (pg 208).



Format Memory Card

Format the card. *Note that formatting permanently deletes all pictures and other data on the card.* Before formatting, be sure to make backup copies as required.

✔ During Formatting

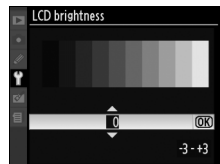
Do not turn the camera off or remove memory cards during formatting.

✍ Two-Button Format

Memory cards can also be formatted by pressing the  (◻) and  buttons for about two seconds (pg. 75).

LCD Brightness

Press ▲ or ▼ to choose from seven settings for monitor brightness. Choose higher values for increased brightness, lower values for reduced brightness.



Clean Image Sensor

Select this option to remove dust from the image sensor or to choose options for automatic image sensor cleaning (pg. 244).

Lock Mirror up for Cleaning

Lock the mirror in the up position to allow inspection or manual cleaning of the low-pass filter that protects the camera image sensor (pg. 246).

Video Mode

When connecting the camera to a television or VCR via the video connector, be sure the camera video mode matches the device video standard (NTSC or PAL).

HDMI

The camera is equipped with an HDMI (**H**igh-**D**efinition **M**ultimedia **I**nterface) connector, allowing pictures to be played back on high-definition televisions or monitors using a type C cable (available separately from commercial suppliers). Before connecting the camera to high-definition device, choose the HDMI format from the options below.

Option	Description
AUTO Auto (default)	The camera automatically selects the appropriate format.
480P 480p (progressive)	640 × 480 (progressive) format
576P 576p (progressive)	720 × 576 (progressive) format
720P 720p (progressive)	1,280 × 720 (progressive) format
1080i 1080i (interlaced)	1,920 × 1,080 (interlaced) format

The camera monitor turns off automatically when an HDMI device is connected.




World Time

Change time zones, set the camera clock, choose the date display order, and turn daylight saving time on or off.

Option	Description
Time zone	Choose a time zone. The camera clock is automatically set to the time in the new time zone.
Date and time	Set the camera clock (pg. 27).
Date format	Choose the order in which the day, month, and year are displayed.
Daylight saving time	Turn daylight saving time on or off. The camera clock will automatically be advanced or set back one hour. The default setting is Off .

The Clock Battery

The camera clock is powered by an independent, rechargeable power source, which is charged as necessary when the main battery is installed or the camera is powered by an optional EH-5a or EH-5 AC adapter (pg. 239). Two days of charging will power the clock for about three months. If the  icon flashes in the control panel, the clock battery is exhausted and the clock has been reset. Set the clock to the correct time and date.

Language

Choose a language for camera menus and messages. The following options are available.

Option	Description
Dk Dansk	Danish
De Deutsch	German
En English	English
Es Español	Spanish
Fi Suomi	Finnish
Fr Français	French
It Italiano	Italian
Nl Nederlands	Dutch
No Norsk	Norwegian
Pl Polski	Polish

Option	Description
Pt Português	Portuguese
Ru Русский	Russian
Sv Svenska	Swedish
繁 中文(繁體)	Traditional Chinese
简 中文(简体)	Simplified Chinese
日 日本語	Japanese
한 한글	Korean

Image Comment

Add a comment to new photographs as they are taken. Comments can be viewed in ViewNX (supplied) or Capture NX 2 (available separately; pg. 240). The comment is also visible on the third page of the photo information display (pg. 132).

- **Done:** Save changes and return to the setup menu.
- **Input comment:** Input a comment as described on page 169. Comments can be up to 36 characters long.
- **Attach comment:** Select this option to attach the comment to all subsequent photographs. **Attach comment** can be turned on and off by highlighting it and pressing ►.



Auto Image Rotation

Photographs taken while **On** (the default option) is selected contain information on camera orientation, allowing them to be rotated automatically during playback (pg. 128) or when viewed in ViewNX or Capture NX 2 (available separately; pg. 240). The following orientations are recorded:



Landscape (wide) orientation





Camera rotated 90° clockwise



Camera rotated 90° counterclockwise

Camera orientation is not recorded when **Off** is selected. Choose this option when taking photographs with the lens pointing up or down.

Auto Image Rotation

In  and  release modes (pg. 65), the orientation recorded for the first shot applies to all photographs in the same burst, even if camera orientation is changed during shooting.

Rotate Tall

To automatically rotate “tall” (portrait-orientation) photographs for display during playback, select **On** for the **Rotate tall** option in the playback menu (pg. 160). Note that because the camera itself is already in the appropriate orientation during shooting, images are not rotated automatically during image review (pg. 128).



Image Dust off Ref Photo

Acquire reference data for the Image Dust Off option in Capture NX 2 (available separately; for more information, see the Capture NX 2 manual).

Image dust off ref photo is available only when a CPU lens is mounted on the camera. A lens with a focal length of at least 50 mm is recommended. When using a zoom lens, zoom all the way in.

1 Choose a start option.

Highlight one of the following options and press **OK**. To exit without acquiring image dust off data, press **MENU**.



- **Start:** The message shown at right will be displayed and “rEF” will appear in the viewfinder and control panel displays.
- **Clean sensor and then start:** Select this option to clean the image sensor before starting. The message shown at right will be displayed and “rEF” will appear in the viewfinder and control panel displays when cleaning is complete.

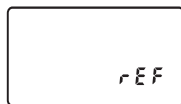


Image Sensor Cleaning

Dust off reference data recorded before image sensor cleaning is performed can not be used with photographs taken after image sensor cleaning is performed. Select **Clean sensor and then start** only if the dust off reference data will not be used with existing photographs.

2 Frame a featureless white object in the viewfinder.

With the lens about ten centimeters (four inches) from a well-lit, featureless white object, frame the object so that it fills the viewfinder and then press the shutter-release button halfway.

In autofocus mode, focus will automatically be set to infinity; in manual focus mode, set focus to infinity manually.

3 Acquire dust off reference data.

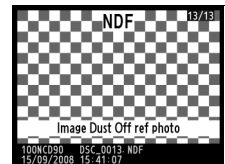
Press the shutter-release button the rest of the way down to acquire Image Dust Off reference data. The monitor turns off when the shutter-release button is pressed. Note that noise reduction will be performed if the subject is poorly lit, increasing recording times.

If the reference object is too bright or too dark, the camera may be unable to acquire Image Dust Off reference data and the message shown at right will be displayed. Choose another reference object and repeat the process from step 1.



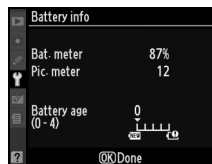
Image Dust Off Reference Data

The same reference data can be used for photographs taken with different lenses or at different apertures. Reference images can not be viewed using computer imaging software. A grid pattern is displayed when reference images are viewed on the camera; histograms and highlights are not displayed.



Battery Info

View information on the battery currently inserted in the camera (if the camera is powered by an optional MB-D80 battery pack containing two EN-EL3e batteries, information for each battery will be listed separately; only the battery level is displayed when AA batteries are used).



Item	Description
Bat. meter	The current battery level expressed as a percentage.
Pic. meter	The number of times the shutter has been released with the current battery since the battery was last charged. Note that the camera may sometimes release the shutter without recording a photograph, for example when measuring preset white balance.
Battery age	A five-level display showing battery age. 0 (NEW) indicates that battery performance is unimpaired, 4 (Full) that the battery has reached the end of its charging life and should be replaced. Note that batteries charged at temperatures under about 5 °C (41 °F) may show a temporary drop in charging life; the charging life display will however return to normal once the battery has been recharged at a temperature of about 20 °C (68 °F) or higher.

GPS

Adjust settings for connection to a GPS unit (pg. 124).

Eye-Fi Upload

This option is displayed only when one of the following 2GB Eye-Fi memory cards (available separately from third-party suppliers) is inserted in the camera: Eye-Fi Card, Eye-Fi Home, Eye-Fi Share, and Eye-Fi Explore (at the time of writing, Eye-Fi memory cards were approved for use in the United States of America only; be sure that Eye-Fi card firmware has been updated to the latest version). Choose **Enable** to upload JPEG images taken with the camera to a preselected destination.















Note that pictures will not be uploaded if signal strength is insufficient. Choose **Disable** where wireless devices are prohibited.

Firmware Version

View the current camera firmware version.

The Retouch Menu: Creating Retouched Copies

The options in the retouch menu are used to create trimmed or retouched copies of the photographs on the memory card. The retouch menu is only available when a memory card containing photographs is inserted in the camera. To display the retouch menu, press **MENU** and press **◀** to highlight the tab for current menu, then press **▲** or **▼** to highlight the retouch menu tab; for more information, see page 19.

Option	See page	Option	See page
 D-Lighting *	212	 Image overlay	218
 Red-eye correction *	212	 NEF (RAW) processing	220
 Trim	213	 Quick retouch *	221
 Monochrome *	214	 Straighten	221
 Filter effects *	215	 Distortion control	222
 Color balance *	216	 Fisheye	222
 Small picture	216	 Side-by-side comparison	223

* Not available with photographs taken with **Monochrome** selected for **Set Picture Control** or JPEG copies of NEF (RAW) images created with **Monochrome** selected for **Set Picture Control** (cross screen filter effects can be applied to monochrome images).



Creating Retouched Copies

Except in the case of **Image overlay** (pg. 218) and **Side-by-side comparison** (pg. 223), the photographs to be retouched can be selected in full-frame playback as well as from the retouch menu.

■ Creating Retouched Copies in Full-Frame Playback

1 Choose a picture.

Display the desired picture in full-frame playback (pg. 128).



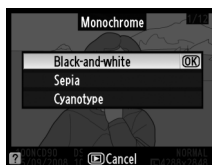
2 Display the retouch menu.

Press **OK** to display the retouch menu.




3 Select retouch options.

Highlight the desired item in the retouch menu and press **▶** to display retouch options (for more information, see the section for the selected item on the following pages). To return to full-frame playback without creating a retouched copy, press **▶**.



4 Create a retouched copy.

Press **OK** to create a retouched copy. Retouched copies are indicated by a  icon.



Retouch

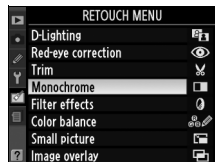
The D90 may not be able to display or create retouched copies of images created with other devices.

The monitor will turn off automatically if no operations are performed for the length of time selected for Custom Setting c4 (**Monitor off delay**) > **Menus**. The default is 20 s.

■ Creating Retouched Copies from the Retouch Menu

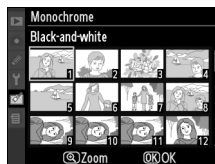
1 Select an item in the retouch menu.

Press ▲ or ▼ to highlight an item, ► to select. Depending on the option selected, a menu may be displayed; highlight an option and press ►.



2 Select a picture.

The pictures on the memory card will be displayed. Use the multi selector to highlight a picture (to view the highlighted picture full screen, press and hold the Ⓚ button).




3 Display retouch options.

Press Ⓚ to display retouch options (see the section for the selected option for details). To exit without creating a retouched copy, press MENU.



4 Create a retouched copy.

Press Ⓚ to create a retouched copy. Retouched copies are indicated by a  icon.



Retouching Copies

Copies created with **Trim** or **Small picture** can not be further modified. **Quick retouch** is not available with copies created with D-lighting; similarly, **D-lighting** is not available with copies created with **Quick retouch**. D-lighting, red-eye correction, filter effects (cross screen excepted), quick retouch, and color balance can not be applied to monochrome copies. With the exception of **Cross screen**, filter effects can not be applied to copies created with filters other than **Cross screen**. **Image overlay** can be applied multiple times. Otherwise the options in the retouch menu can each be applied once to existing copies, although multiple edits may result in loss of detail.

Image Quality

Except in the case of copies created with **Trim** (pg. 213), **Small picture** (pg. 216), and **Image overlay** (pg. 218), copies created from JPEG images are the same size and quality as the original, while copies created from NEF (RAW) photos are saved as large fine-quality JPEG images.

D-Lighting

D-lighting brightens shadows, making it ideal for dark or backlit photographs.



Before



After

Press ▲ or ▼ to choose the amount of correction performed. The effect can be previewed in the edit display. Press ⓧ to copy the photograph.

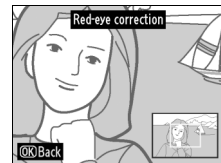


Red-Eye Correction

This option is used to correct “red-eye” caused by the flash, and is available only with photographs taken using the flash. The photograph selected for red-eye correction is previewed as shown at right. Confirm the effects of red-eye correction and create a copy as described in the following table. Note that red-eye correction may not always produce the expected results and may in very rare circumstances be applied to portions of the image that are not affected by red-eye; check the preview thoroughly before proceeding.



To	Use	Description
Zoom in		Press button to zoom in, button to zoom out. While photo is zoomed in, use multi selector to view areas of image not visible in monitor. Keep multi selector pressed to scroll rapidly to other areas of frame. Navigation window is displayed when zoom buttons or multi selector is pressed; area currently visible in monitor is indicated by yellow border. Press to cancel zoom.
Zoom out		
View other areas of image		If the camera detects red-eye in the selected photograph, a copy will be created that has been processed to reduce its effects. No copy will be created if the camera is unable to detect red-eye.
Cancel zoom		
Create copy		



Trim

Create a cropped copy of the selected photograph. The selected photograph is displayed with the selected crop shown in yellow; create a cropped copy as described in the following table.



To	Use	Description
Increase size of crop		Press the button to increase the size of the crop.
Reduce size of crop		Press the button to reduce the size of the crop.
Change crop aspect ratio		Rotate the main command dial to switch between aspect ratios of 3 : 2, 4 : 3, and 5 : 4.
Move crop		Use multi selector to move the crop to another area of the image.
Preview crop		Press center of multi selector to preview cropped image.
Create copy		Save the current crop as a separate file.

Trim: Image Quality and Size

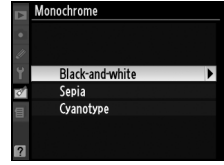
Copies created from NEF (RAW) or NEF (RAW) + JPEG photos have an image quality of JPEG fine (pg. 62); copies created from JPEG photos have the same image quality as the original. The size of the copy varies with crop size and aspect ratio.

Aspect ratio	Possible sizes
3 : 2	3,424 × 2,280, 2,560 × 1,704, 1,920 × 1,280, 1,280 × 856, 960 × 640, 640 × 424
4 : 3	3,424 × 2,568, 2,560 × 1,920, 1,920 × 1,440, 1,280 × 960, 960 × 720, 640 × 480
5 : 4	3,216 × 2,568, 2,400 × 1,920, 1,808 × 1,440, 1,200 × 960, 896 × 720, 608 × 480



Monochrome

Copy photographs in **Black-and-white**, **Sepia**, or **Cyanotype** (blue and white monochrome).

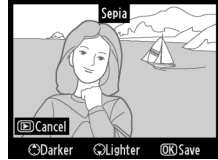


Selecting **Sepia** or **Cyanotype** displays a preview of the selected image; press ▲ to increase color saturation, ▼ to decrease. Press ⌘ to create a monochrome copy.

Increase saturation

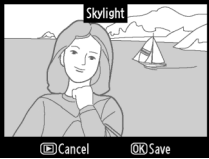
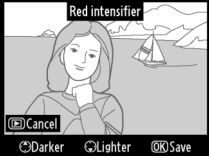
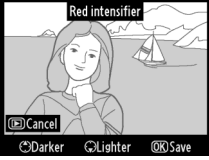
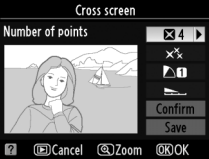


Decrease saturation



Filter Effects

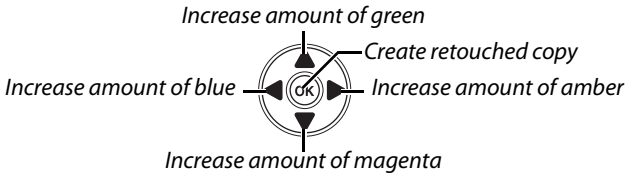
Choose from the following color filter effects. After adjusting filter effects as described below, press **Ⓜ** to copy the photograph.

Option	Description
Skylight	Creates the effect of a skylight filter, making the picture less blue. The effect can be previewed in the monitor as shown at right. 
Warm filter	Creates a copy with warm tone filter effects, giving the copy a “warm” red cast. The effect can be previewed in the monitor. 
Red intensifier Green intensifier Blue intensifier	Intensify reds (Red intensifier), greens (Green intensifier), or blues (Blue intensifier). Use the multi selector to choose from three intensity levels: 1 (high), 2 (medium), or 3 (low). 
Cross screen	Add starburst effects to light sources. <ul style="list-style-type: none"> • Number of points: Choose from four, six, or eight. • Filter amount: Choose the brightness of the light sources affected. • Filter angle: Choose the angle of the points. • Length of points: Choose the length of points. • Confirm: Preview the effects of the filter as shown at right. Press Ⓜ to preview the copy full frame. • Save: Create a retouched copy. 



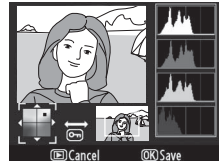
Color Balance

Use the multi selector to create a copy with modified color balance as shown below. The effect is displayed in the monitor together with red, green, and blue histograms (pg. 130) giving the distribution of tones in the copy.



Zoom

To zoom in on the image displayed in the monitor, press the \mathbb{Q} button. The histogram will be updated to show data only for the portion of the image displayed in the monitor. While the image is zoomed in, press the \mathbb{Z} button to toggle playback zoom and zoom and scroll the image as described on page 138.



Small Picture

Create a small copy of the selected picture. The following sizes are available:

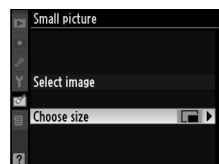
Option	Description
640×480	Suited to television playback.
320×240	Suited to display on Web pages.
160×120	Suitable for e-mail.

The small picture option can be used during full-frame playback as described on page 210. The procedure for selecting pictures after choosing **Small picture** from the retouch menu, however, differs from that described at the beginning of this section: instead of selecting a single photograph and then choosing a picture size, the user selects a picture size first and then selects one or more photographs to copy at the selected size as described below.

Selecting **Small picture** from the retouch menu displays the menu shown in Step 1. Follow the steps below to create small copies of multiple pictures.

1 Select Choose size.

Highlight **Choose size** and press \blacktriangleright .



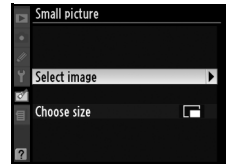
2 Choose the desired size.

Highlight desired size and press **OK** to select and return to the previous menu.



3 Choose Select image.

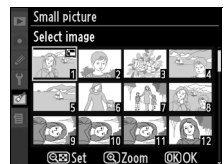
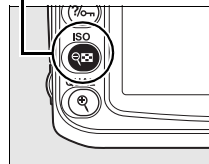
Highlight **Select image** and press **▶**.



4 Select pictures.

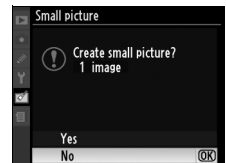
Highlight pictures using the multi selector and press the **☒** button to select or deselect (pg. 160). Selected pictures are marked by an icon.

☒ button



5 Press **OK** to complete the operation.

Press **OK**. A confirmation dialog will be displayed; highlight **Yes** and press **OK** to copy pictures at the selected size and return to playback. To exit without creating copies, highlight **No** and press **OK**, or press **MENU** to exit to the retouch menu.



Viewing Small Pictures

Small pictures are indicated by a gray border during full-frame playback. Playback zoom is not available when small pictures are displayed.



Image Overlay

Image overlay combines two existing NEF (RAW) photographs to create a single picture that is saved separately from the originals; the results, which make use of RAW data from the camera image sensor, are noticeably better than overlays created in an imaging application. The new picture is saved at current image quality and size settings; before creating an overlay, set image quality and size (pp. 62, 63; all options are available). To create an NEF (RAW) copy, choose an image quality of **NEF (RAW)**.

1 Select Image overlay.

Highlight **Image overlay** in the retouch menu and press **▶**. The dialog shown at right will be displayed, with **Image 1** highlighted.



2 Display NEF (RAW) images.

Press **Ⓚ** to display a picture selection dialog listing only NEF (RAW) images created with this camera (note that hidden images are not displayed and can not be selected).



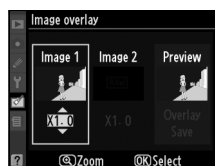
3 Highlight a photograph.

Use the multi selector to highlight the first photograph in the overlay. To view the highlighted photograph full frame, press and hold the **Ⓚ** button.



4 Select the highlighted photograph.

Press **Ⓚ** to select the highlighted photograph and return to the preview display. The selected image will appear as **Image 1**.



5 Set gain.

Optimize exposure for the overlay by pressing **▲** or **▼** to select the gain for image 1 from values between 0.1 and 2.0. The default value is 1.0; selecting 0.5 cuts gain in half, while selecting 2.0 doubles gain. The effects of gain are visible in the **Preview** column.



6 Select the second photograph.

Press ◀ or ▶ to highlight **Image 2**. Repeat Steps 2–5 to select the second photo and adjust gain.



7 Highlight the Preview column.

Press ◀ or ▶ to highlight the **Preview** column.



8 Preview the overlay.

Press ▲ or ▼ to highlight **Overlay** and press OK (to save the overlay without displaying a preview, highlight **Save** and press OK). To return to Step 7 and select new photos or adjust gain, press



9 Save the overlay.

Press OK while the preview is displayed to save the overlay. After an overlay is created, the resulting image will be displayed full-frame in the monitor.

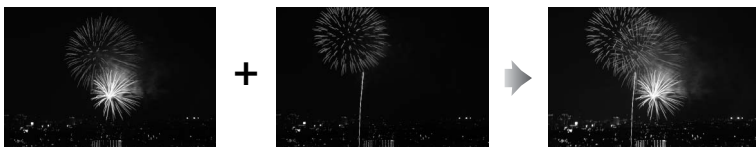


Image Overlay

The overlay has the same photo info (including date of recording, metering, shutter speed, aperture, exposure mode, exposure compensation, focal length, and image orientation) and values for white balance and Picture Control as the photograph selected for **Image 1**.

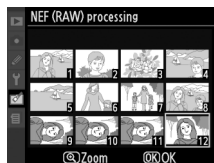


NEF (RAW) Processing

Create JPEG copies of NEF (RAW) photographs.

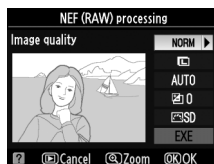
1 Select NEF (RAW) processing.

Highlight **NEF (RAW) processing** in the retouch menu and press ► to display a picture selection dialog listing only NEF (RAW) images created with this camera (note that hidden images are not displayed and can not be selected).



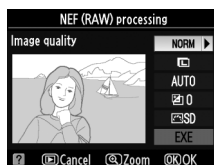
2 Select a photograph.

Use the multi selector to highlight a photograph (to view the highlighted photograph full frame, press and hold the **Q** button). Press **OK** to select the highlighted photograph and proceed to the next step.



3 Adjust NEF (RAW) processing settings.

The following options are available:



Option	Description
Image quality	Choose from FINE , NORM , and BASIC (pg. 62)
Image size	Choose from L , M , and S (pg. 63).
White balance	Choose a white balance setting and adjust fine tuning (pg. 97). This option is not available with images creating using Image overlay .
Exposure comp.	Choose a value for exposure compensation between -3 and +3 in increments of 1 (these increments differ from the steps normally used for exposure compensation).
Set Picture Control	Choose a Picture Control (pg. 109).

4 Copy the photograph.

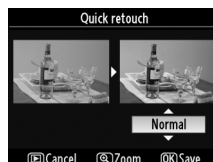
Highlight **EXE** and press **OK** to create a JPEG copy of the selected photograph. To exit without copying the photograph, press the **MENU** button.



Quick Retouch

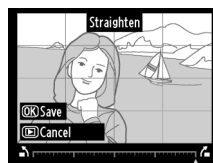
Create copies with enhanced saturation and contrast. D-lighting is applied as required to brighten dark or backlit subjects.

Press **▲** or **▼** to choose the amount of enhancement. The effect can be previewed in the edit display. Press **OK** to copy the photograph.



Straighten

Create a straightened copy of the selected image. Press **▶** to rotate the image clockwise by up to five degrees in increments of approximately 0.25 degrees, **◀** to rotate it counterclockwise (note that edges of the image will be trimmed to create a square copy). Press **OK** to copy the photograph, or press **▶** to exit to playback without creating a copy.



Distortion Control

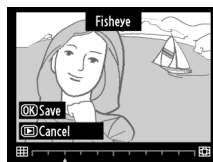
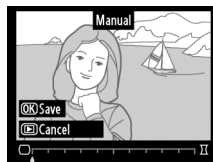
Create copies with reduced peripheral distortion. Select **Auto** to let the camera correct distortion automatically and then make fine adjustments using the multi selector, or select **Manual** to reduce distortion manually. Press **▶** to reduce barrel distortion, **◀** to reduce pin-cushion distortion (note that greater amounts of distortion control result in more of the edges being cropped out). Press **ⓧ** to copy the photograph, or press **▶** to exit to playback without creating a copy.

Auto

Auto is for use only with pictures taken with type G and D lenses (PC, fisheye, and certain other lenses excluded; for more information, see the websites listed on page xviii). Results are not guaranteed with other lenses.

Fisheye

Create copies that appear to have been taken with a fisheye lens. Press **▶** to increase the effect (this also increases the amount of that will be cropped out at the edges of the image), **◀** to reduce it. Press **ⓧ** to copy the photograph, or press **▶** to exit to playback without creating a copy.




Side-by-Side Comparison

Compare retouched copies to the original photographs.

■ Making a Side-by-Side Comparison

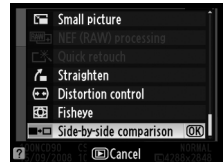
1 Select a picture.

Use the multi selector to select a picture and press **OK**. Only retouched copies (shown by a ) or photographs that have been retouched can be selected.



2 Select Side-by-side comparison.

Highlight **Side-by-side comparison** and press **OK**.

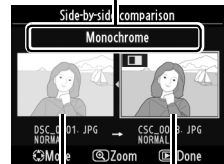


3 Compare the copy with the original.

The source image is displayed on the left, the retouched copy on the right, with the options used to create the copy listed at the top of the display. Press **▲**, **▼**, **◀**, or **▶** as indicated by the arrow adjacent to the highlighted image to switch between the source image and the retouched copy. To view the highlighted picture full frame, press and hold the **Q** button.



Options used to created copy



Source image Retouched copy

If the copy was created from two images using **Image overlay**, press **▲** or **▼** to view the other source image. If multiple copies exist for the current source image, press **▲** or **▼** to view the other copies. To exit to playback mode, press the **▶** button, or press **OK** to return to playback with the highlighted image displayed.

Side-by-Side Comparison

The source image will not be displayed if the copy was created from a photograph that has since been deleted or is currently protected (pg. 139) or hidden (pg. 162).



Recent Settings/My Menu

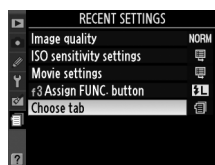
The camera offers a choice of two custom menus: a *recent settings menu* consisting of the twenty most recently used settings, added to the top of the menu in the order they are used, and *My Menu*, a customized list of options from the playback, shooting, Custom Settings, setup, and retouch menus. To display the custom menu, press **MENU** and press ◀ to highlight the tab for current menu, then press ▲ or ▼ to highlight the custom menu tab; for more information, see page 19.

■ Choose Tab: Choosing a Custom Menu

Both the recent settings menu and My Menu contain a **Choose tab** option for choosing the menu displayed. To switch back and forth between the recent settings menu and My Menu, follow the steps below.

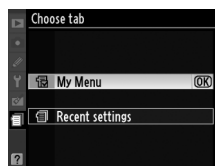
1 Select Choose tab.

In the RECENT SETTINGS menu or MY MENU, highlight **Choose tab** and press ▶.



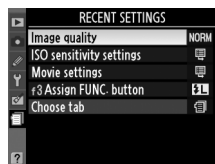
2 Select the desired menu.

Highlight **Recent settings** or **My Menu** and press OK. The selected menu will be displayed.



Recent Settings: Viewing Recent Settings

The recent settings menu lists the twenty most recently used settings.



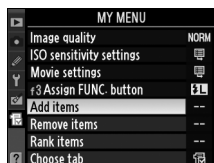
My Menu: Creating a Custom Menu

The **My Menu** option can be used to create and edit a customized list of up to 20 options from the playback, shooting, Custom Settings, setup, and retouch menus. Options can be added, deleted, and reordered as described below.

■ Adding Options to My Menu

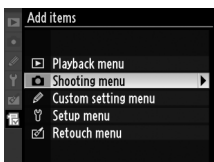
1 Select Add items.

In My Menu, highlight **Add items** and press **▶**.




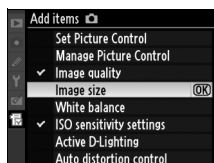
2 Select a menu.

Highlight the name of the menu containing the option you wish to add and press **▶**.



3 Select an item.

Highlight the desired menu item and press **OK**. Items currently in My Menu are indicated by a checkmark; items indicated by a  icon can not be selected.



4 Position the new item.

Press **▲** or **▼** to move the new item up or down in My Menu. Press **OK** to add the new item.

Repeat steps 1–4 to select additional items.



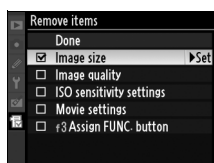
■ Deleting Options from My Menu

1 Select Remove items.

In My Menu, highlight **Remove items** and press **▶**.

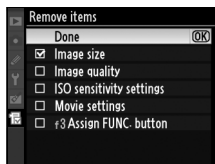
2 Select items.

Highlight items and press **▶** to select or deselect. Selected items are indicated by a check mark.



3 Select Done.

Highlight **Done** and press **OK**.





4 Delete the selected items.

A confirmation dialog will be displayed. Press **OK** to delete the selected items.



Deleting Items in My Menu

To delete the item currently highlighted in My Menu, press the  button. A confirmation dialog will be displayed; press  again to remove the selected item from My Menu.

Reordering Options in My Menu

1 Select Rank items.

In My Menu, highlight **Rank items** and press **▶**.

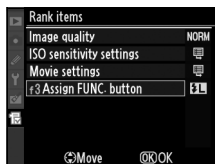
2 Select an item.

Highlight the item you wish to move and press **OK**.



3 Position the item.

Press **▲** or **▼** to move the item up or down in My Menu and press **OK**. Repeat Steps 2–3 to reposition additional items.





Technical Notes

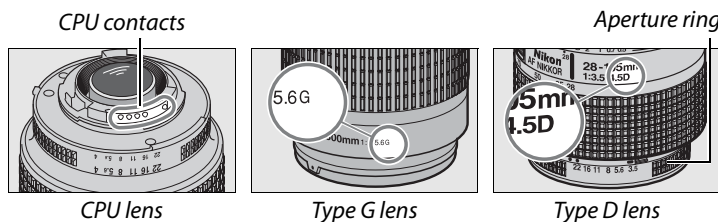
This chapter covers the following topics:

Compatible Lenses	228
Compatible CPU Lenses.....	229
Non-CPU Lenses	230
Optional Flash Units (Speedlights)	233
The Nikon Creative Lighting System (CLS).....	233
Flash Contacts	238
Other Accessories	239
Caring for the Camera	243
Storage.....	243
Cleaning	243
The Low-Pass Filter	244
Caring for the Camera and Battery: Cautions	248
Troubleshooting	250
Error Messages	255
Appendix	258
Available Settings and Defaults.....	258
Memory Card Capacity	262
Exposure Program	263
Bracketing Programs.....	264
Flash Control	265
Shutter Speeds Available with the Built-in Flash.....	265
Aperture, Sensitivity, and Flash Range.....	266
Specifications	267



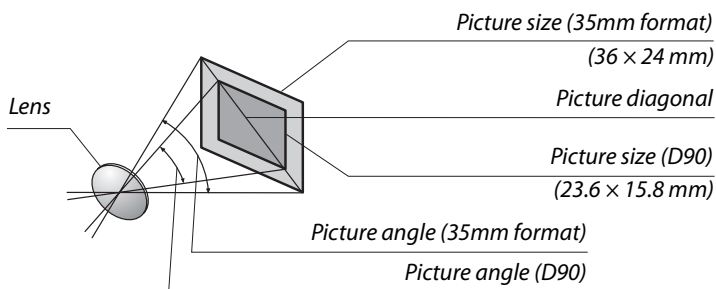
Compatible Lenses

CPU lenses (particularly types G and D) are recommended for use with the D90. CPU lenses can be identified by the presence of CPU contacts, type G and D lenses by a letter on the lens barrel. Type G lenses are not equipped with a lens aperture ring.



Calculating Picture Angle

The size of the area exposed by a 35 mm camera is 36×24 mm. The size of the area exposed by the D90, in contrast, is 23.6×15.8 mm, meaning that the picture angle of a 35mm camera is approximately 1.5 times that of the D90. The approximate focal length of lenses for the D90 in 35 mm format can be calculated by multiplying the focal length of the lens by about 1.5.



Lens f-number

The f-number given in lens names is the maximum aperture of the lens.

Non-CPU Lenses¹

Non-CPU lenses include manual focus lenses and other lenses without a built-in CPU. The following is a list of compatible non-CPU lenses and accessories.

Lens/accessory	Camera setting		Focus		Mode		Metering
	AF	M (with electronic rangefinder)	M		M		
AI-, AI-modified, Nikkor or Nikon Series E lenses	—	✓ ²	✓	—	✓ ³	—	
Medical-Nikkor 120mm f/4	—	✓	✓	—	✓ ^{3,4}	—	
Reflex-Nikkor	—	—	✓	—	✓ ³	—	
PC-Nikkor	—	✓ ⁵	✓	—	✓ ³	—	
AI-type Teleconverter	—	✓ ⁶	✓	—	✓ ³	—	
PB-6 Bellows Focusing Attachment ⁷	—	✓ ²	✓	—	✓ ³	—	
Auto extension rings (PK-series 11A, 12, or 13; PN-11)	—	✓ ²	✓	—	✓ ³	—	

1 Some lenses can not be used (see below).

2 With maximum aperture of f/5.6 or faster.

3 Electronic analog exposure display can not be used.

4 Shutter speeds slower than $\frac{1}{60}$ s not available.

5 Can not be used with shifting or tilting.

6 With maximum effective aperture of f/5.6 or faster.

7 Attach in vertical orientation (can be used in horizontal orientation once attached).

✓ Compatible Non-CPU Lenses

The lenses listed above may only be used when the camera is in mode **M**. Selecting another mode disables the shutter release. Aperture must be adjusted manually via the lens aperture ring and the camera autofocus system, metering, electronic analog exposure display, depth-of-field preview, and i-TTL flash control can not be used.

✓ Incompatible Accessories and Non-CPU Lenses

The following accessories and non-CPU lenses can NOT be used with the D90:

- TC-16AS AF teleconverter
- Non-AI lenses
- Lenses that require the AU-1 focusing unit (400mm f/4.5, 600mm f/5.6, 800mm f/8, 1200mm f/11)
- Fisheye (6mm f/5.6, 7.5mm f/5.6, 8mm f/8, OP 10mm f/5.6)
- 2.1cm f/4
- Extension Ring K2
- 180–600mm f/8 ED (serial numbers 174041–174180)
- 360–1200mm f/11 ED (serial numbers 174031–174127)
- 200–600mm f/9.5 (serial numbers 280001–300490)
- AF lenses for the F3AF (AF 80mm f/2.8, AF 200mm f/3.5 ED, AF Teleconverter TC-16)
- PC 28mm f/4 (serial number 180900 or earlier)
- PC 35mm f/2.8 (serial numbers 851001–906200)
- PC 35mm f/3.5 (old type)
- Reflex 1000mm f/6.3 (old type)
- Reflex 1000mm f/11 (serial numbers 142361–143000)
- Reflex 2000mm f/11 (serial numbers 200111–200310)

Red-Eye Reduction

Lenses that block the subject's view of the AF-assist illuminator may interfere with red-eye reduction.

AF-Assist Illumination

AF-assist illumination is not available with the following lenses:

- AF-S NIKKOR 14–24mm f/2.8G ED
- AF-S VR 70–200mm f/2.8G ED
- AF-S 80–200mm f/2.8D ED
- AF 80–200mm f/2.8D ED
- AF VR 80–400mm f/4.5–5.6D ED
- AF-S VR 200mm f/2G ED
- AF-S VR 200–400mm f/4G ED

At ranges under 1 m (3 ft. 3 in.), the following lenses may block the AF-assist illuminator and interfere with autofocus when lighting is poor:

- AF-S DX 12–24mm f/4G ED
- AF-S DX NIKKOR 16–85mm f/3.5–5.6G ED VR
- AF-S 17–35mm f/2.8D ED
- AF-S DX 17–55mm f/2.8G ED
- AF 18–35mm f/3.5–4.5D ED
- AF-S DX 18–70mm f/3.5–4.5G ED
- AF-S DX NIKKOR 18–105mm f/3.5–5.6G ED VR
- AF-S DX VR 18–200mm f/3.5–5.6G
- AF 20–35mm f/2.8D
- AF-S NIKKOR 24–70mm f/2.8G ED
- AF-S 24–85mm f/3.5–4.5G ED
- AF 24–85mm f/2.8–4D
- AF-S VR 24–120mm f/3.5–5.6G ED
- AF 24–120mm f/3.5–5.6D
- AF-S 28–70mm f/2.8D ED
- AF 28–200mm f/3.5–5.6G ED
- AF Micro 70–180mm f/4.5–5.6D ED
- AF-S VR Micro 105mm f/2.8G ED
- AF Micro 200mm f/4D ED



✓ The Built-in Flash

The built-in flash can be used with CPU lenses with focal lengths of 18–300 mm. Remove lens hoods to prevent shadows. The flash has a minimum range of 60 cm (2 ft.) and can not be used in the macro range of macro zoom lenses. The flash may be unable to light the entire subject with the following lenses at ranges less than those given below:

Lens	Zoom position	Min. range
AF-S DX 12–24mm f/4G ED	20 mm	2.0 m/6 ft. 7 in.
	24 mm	1.0 m/3 ft. 3 in.
AF-S DX NIKKOR 16–85mm f/3.5–5.6G ED VR	18 mm	2.0 m/6 ft. 7 in.
	20 mm	1.0 m/3 ft. 3 in.
AF-S 17–35 mm f/2.8D ED	24 mm	2.0 m/6 ft. 7 in.
	28 mm, 35 mm	1.0 m/3 ft. 3 in.
AF-S DX 17–55 mm f/2.8G ED	28 mm	1.5 m/4 ft. 11 in.
	35 mm	1.0 m/3 ft. 3 in.
AF 18–35mm f/3.5–4.5D ED	24 mm	1.0 m/3 ft. 3 in.
AF-S DX 18–70mm f/3.5–4.5G ED	18 mm	1.0 m/3 ft. 3 in.
AF-S DX NIKKOR 18–105 mm f/3.5–5.6G ED VR	20 mm	2.5 m/8 ft. 2 in.
	24 mm	1.0 m/3 ft. 3 in.
AF-S DX 18–135 mm f/3.5–5.6G ED	18 mm	1.5 m/4 ft. 11 in.
AF-S DX VR 18–200mm f/3.5–5.6G ED	24 mm, 35 mm	1.0 m/3 ft. 3 in.
AF 20–35 mm f/2.8D	20 mm	1.5 m/4 ft. 11 in.
	24 mm	1.0 m/3 ft. 3 in.
AF-S NIKKOR 24–70 mm f/2.8G ED	35 mm	1.5 m/4 ft. 11 in.
AF-S VR 24–120mm f/3.5–5.6G ED	24 mm	1.0 m/3 ft. 3 in.
PC-E NIKKOR 24 mm f/3.5 ED*	24 mm	2.0 m/6 ft. 7 in.
AF-S 28–70mm f/2.8D ED	35 mm	1.5 m/4 ft. 11 in.
	50 mm	1.0 m/3 ft. 3 in.
AF-S VR 200–400mm f/4G ED	200 mm	3.0 m/9 ft. 10 in.
	250 mm, 300 mm	2.5 m/8 ft. 2 in.

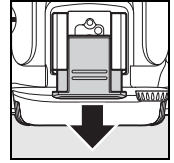
* Can not be used with shifting or tilting.

When used with the AF-S NIKKOR 14–24 mm f/2.8G ED, the flash will be unable to light the entire subject at all ranges.

With the exceptions of the AI-S ED 200mm f/2 and AI ED 200mm f/2, the built-in flash can also be used with AI- and AI-modified Nikkor and Nikon Series E non-CPU lenses with focal lengths of 18–200 mm. At the 35 mm zoom position, AI-S 25–50mm f/4, AI 25–50mm f/4, and AI-S 35–70mm lenses must be used at ranges of 1.0 m/3ft. 3 in. or more. AI 50–300mm f/4.5, AI-modified 50–300mm f/4.5, AI-S 50–300mm f/4.5 ED, and AI-modified 85–250mm f/4 lenses must be used at zoom positions of 135 mm or above, AI 50–300 f/4.5 ED lenses at 105 mm or above.

Optional Flash Units (Speedlights)

The D90 can be used with CLS-compatible flash units. Remove the accessory shoe cover when attaching optional flash units. The built-in flash will not fire when an optional flash unit is attached.



The Nikon Creative Lighting System (CLS)

Nikon's advanced Creative Lighting System (CLS) offers improved communication between the camera and compatible flash units for improved flash photography. The Creative Lighting System supports the following features:

- **i-TTL flash control:** Improved through-the-lens (TTL) flash control for use with CLS (see page 265). Flash level is set using monitor pre-flashes to measure the light reflected by the subject, ensuring optimal flash output.
- **Advanced Wireless Lighting:** Allows i-TTL flash control with remote wireless flash units.
- **FV lock** (pg. 198): Locks flash level at the metered value, allowing a series of photographs to be taken at the same flash level.
- **Auto FP High-Speed Sync** (pg. 195): Allows the flash to be used at the highest shutter speed supported by the camera, making it possible to choose the maximum aperture for reduced depth of field.




■ CLS-Compatible Flash Units

The D90 can be used with the following CLS-compatible flash units: the SB-900, SB-800, SB-600, SB-400, SB-R200, and SU-800.

The SB-900, SB-800, SB-600, SB-400, and SB-R200

The principal features of these flash units are listed below.

Flash unit		SB-900 ¹	SB-800	SB-600	SB-400	SB-R200 ²
Feature						
Guide No. ³	ISO 100	34/111	38/125	30/98	21/69	10/32
	ISO 200	48/157	53/175	42/138	30/98	14/49
Auto power zoom (mm)		17–200	24–105	24–85	— ⁴	— ⁵
Wide panel (mm)		12, 14, 17	14, 17	14	—	—
Head rotation		7° down, 90° up, 180° left/right	7° down, 90° up, 180° left, 90° right	90° up, 180° left, 90° right	90° up	60° down (toward lens light axis), 45° up (away from light axis)

1 If a color filter is attached to the SB-900 when **AUTO** or  (flash) is selected for white balance, the camera will automatically detect the filter and adjust white balance appropriately.

2 Controlled remotely with built-in flash in commander mode or using optional SB-900, SB-800 flash unit or SU-800 wireless Speedlight commander.

3 m/ft., 20 °C (68 °F), SB-900, SB-800 and SB-600 at 35 mm zoom head position; SB-900 with standard illumination.

4 27 mm zoom coverage.

5 24 mm zoom coverage.

SU-800 Wireless Speedlight Commander

When mounted on a CLS-compatible camera, the SU-800 can be used as a commander for remote SB-900, SB-800, SB-600, or SB-R200 flash units. The SU-800 itself is not equipped with a flash.


✓ Use Only Nikon Flash Accessories

Use only Nikon flash units. Negative voltages or voltages over 250 V applied to the accessory shoe could not only prevent normal operation, but damage the sync circuitry of the camera or flash. Before using a Nikon flash unit not listed in this section, contact a Nikon-authorized service representative for more information.

Guide Number

To calculate the range of the flash at full power, divide the Guide Number by the aperture. For example, at ISO 100 the SB-800 has a Guide Number of 38 m or 125 ft. (35 mm zoom head position); its range at an aperture of f/5.6 is $38 \div 5.6$ or about 6.8 meters (or in feet, $125 \div 5.6 =$ approximately 23 ft. 7 in.). For each twofold increase in ISO sensitivity, multiply the Guide Number by the square root of two (approximately 1.4).

The following features are available with the SB-900, SB-800, SB-600, SB-400, SB-R200, and SU-800:

Flash unit		Advanced Wireless Lighting							
		SB-900	SB-800	SB-600	SB-400	Commander		Remote	
						SB-900	SU-800 ¹	SB-900	SB-800
Flash mode/feature	SB-800	SB-600	SB-400	SB-900	SU-800 ¹	SB-900	SB-800	SB-600	SB-R200
i-TTL	i-TTL balanced fill-flash for digital SLR	✓ ²	✓ ²	✓ ³	✓	✓	✓	✓	✓
AA	Auto aperture	✓ ⁴	—	—	✓ ⁵	✓ ⁵	✓ ⁵	—	—
A	Non-TTL auto	✓ ⁴	—	—	✓ ⁵	—	✓ ⁵	—	—
GN	Distance-priority manual	✓	—	—	—	—	—	—	—
M	Manual	✓	✓	✓ ⁶	✓	✓	✓	✓	✓
RPT	Repeating flash	✓	—	—	✓	✓	✓	✓	—
Auto FP	High-Speed Sync ⁷	✓	✓	—	✓	✓	✓	✓	✓
FV	lock	✓	✓	✓	✓	✓	✓	✓	✓
AF-assist	for multi-area AF ⁸	✓	✓	—	✓	✓	—	—	—
Flash Color	Information Communication	✓	✓	✓	✓	—	—	—	—
REAR	Rear-curtain sync	✓	✓	✓	✓	✓	✓	✓	✓
	Red-eye reduction	✓	✓	✓	✓	—	—	—	—
Auto	zoom	✓	✓	—	✓	—	—	—	—

1 Only available when SU-800 is used to control other flash units.

2 Standard i-TTL flash for digital SLR is used with spot metering or when selected with flash unit.

3 Standard i-TTL flash for digital SLR is used with spot metering.

4 Selected with flash unit.

5 Auto aperture (AA) is used regardless of mode selected with flash unit.

6 Can be selected with camera.

7 Select **On** for Custom Setting e5 (**Auto FP**, pg. 195).

8 CPU lens required.



■ ■ Other Flash Units

The following flash units can be used in non-TTL auto and manual modes. If they are set to TTL, the camera shutter-release button will lock and no photographs can be taken.


Speedlight	SB-80DX, SB-28DX, SB-28, SB-26, SB-25, SB-24	SB-50DX	SB-30, SB-27 ¹ , SB-22S, SB-22, SB-20, SB-16B, SB-15	SB-23, SB-29 ² , SB-21B ² , SB-29S ²
A Non-TTL auto	✓	—	✓	—
M Manual	✓	✓	✓	✓
G Repeating flash	✓	—	—	—
REAR Rear-curtain sync	✓	✓	✓	✓





1 Flash mode is automatically set to TTL and shutter-release is disabled. Set flash unit to **A** (non-TTL auto flash).

2 Autofocus is only available with AF-Micro lenses (60 mm, 105 mm, or 200 mm).

Notes on Optional Speedlights

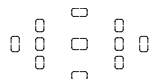

Refer to the Speedlight manual for detailed instructions. If the Speedlight supports the Nikon Creative Lighting System, refer to the section on CLS-compatible digital SLR cameras. The D90 is not included in the “digital SLR” category in the SB-80DX, SB-28DX, and SB-50DX manuals.

If an optional flash unit is attached with the camera in modes other than , the flash will fire whenever a photograph is taken. The following flash modes are available:

- , , and  modes: Fill flash and red-eye reduction. Fill flash is automatically selected if the flash mode is set to off or auto when an optional flash unit is attached. Auto with red-eye reduction becomes red-eye reduction.
-  mode: Auto slow sync becomes slow sync, auto slow sync with red-eye reduction becomes slow sync with red-eye reduction, and off becomes slow sync.

i-TTL flash control can be used at ISO sensitivities between 200 and 3200. At values over 3200, the desired results may not be achieved at some ranges or aperture settings. If the flash-ready indicator blinks for about three seconds after a photograph is taken, the flash has fired at full power and the photograph may be underexposed.







The SB-900, SB-800, SB-600, and SB-400 provide red-eye reduction, while the SB-900, SB-800, SB-600, and SU-800 provide AF-assist illumination. With other Speedlights, the camera AF-assist illuminator is used for AF-assist illumination and red-eye reduction. When used with AF lenses with focal lengths of 17–135 mm, the SB-900 provides active AF-assist illumination for all focus points; note, however, that autofocus is available only with the following focus points:

Focal Length	Focus Points
17–105 mm	
106–135 mm	

When used with AF lenses with focal lengths of 24–105 mm, the SB-800, SB-600 and SU-800 provides active AF-assist illumination to assist autofocus for the following focus points:

Focal Length	Focus Points
24–34 mm	
35–105 mm	

In programmed auto, the maximum aperture (minimum f-number) is limited according to sensitivity (ISO equivalency), as shown below:

Mode	Maximum aperture at ISO sensitivity of				
	200	400	800	1600	3200
P,  ,  ,  ,  , 	4	4.8	5.6	6.7	8
	8	9.5	11	13	16

For each one-step increase in sensitivity (e.g., from 200 to 400), aperture is stopped down by half an f-stop. If the maximum aperture of the lens is smaller than given above, the maximum value for aperture will be the maximum aperture of the lens.

When an SC-series 17, 28, or 29 sync cable is used for off-camera flash photography, correct exposure may not be achieved in i-TTL mode. We recommend that you choose spot metering to select standard i-TTL flash control. Take a test shot and view the results in the monitor.

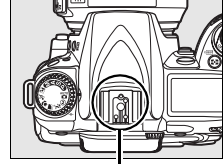
In i-TTL, use the flash panel or bounce adapter provided with the flash unit. Do not use other panels such as diffusion panels, as this may produce incorrect exposure.

Flash Contacts

The D90 is equipped with an accessory shoe for attaching optional flash units directly to the camera and a sync terminal that allows flash units to be connected via a sync cable.

■ ■ *The Accessory Shoe*

Use the accessory shoe to mount optional flash units directly on the camera without a sync cable (pg. 234). The accessory shoe is equipped with a safety lock for Speedlights with a locking pin, such as the SB-900, SB-800, SB-600 and SB-400.



Accessory shoe

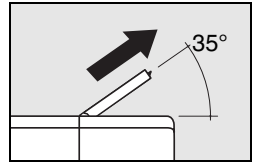
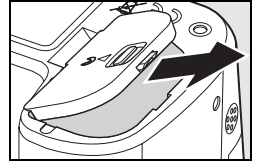
✍ *The AS-15 Accessory Shoe Adapter*

When the AS-15 accessory shoe adapter (available separately) is mounted on the camera accessory shoe, flash accessories can be connected via a sync cable.

Other Accessories

At the time of writing, the following accessories were available for the D90.

Power sources	<ul style="list-style-type: none">• Rechargeable Li-ion Battery EN-EL3e (pp. 22, 23): Additional EN-EL3e batteries are available from local retailers and Nikon service representatives. The EN-EL3e can be recharged using an MH-18a or MH-18 quick charger.• Multi-Power Battery Pack MB-D80: The MB-D80 takes one or two rechargeable Nikon EN-EL3e Li-ion battery or six AA alkaline, NiMH, lithium, or nickel-manganese batteries. It is equipped with a shutter-release button, AE-L/AF-L button, multi selector, and main- and sub-command dials for improved operation when taking photographs in portrait (tall) orientation. When attaching the MB-D80, remove the camera battery-chamber cover as shown at right.• Quick Charger MH-18a (pg. 22): The MH-18a can be used to recharge EN-EL3e battery.• AC Adapter EH-5a/EH-5: These AC adapters can be used to power the camera for extended periods.
Viewfinder eyepiece accessories	<ul style="list-style-type: none">• DK-20C Eyepiece Correction Lenses: Lenses are available with diopters of -5, -4, -3, -2, 0, $+0.5$, $+1$, $+2$, and $+3$ m⁻¹. Use eyepiece correction lenses only if the desired focus can not be achieved with the built in diopter adjustment control (-2.0 to $+1.0$ m⁻¹). Test eyepiece correction lenses before purchase to ensure that the desired focus can be achieved.• Magnifying Eyepiece DK-21M: The DK-21M increases viewfinder magnification to approximately $1.10 \times$ (50 mm f/1.4 lens at infinity; -1.0 m⁻¹).• Magnifier DG-2: The DG-2 magnifies the scene displayed in the viewfinder. Use for close-up photography, copying, telephoto lenses, and other tasks that require added precision. Eyepiece adapter required (available separately).• Eyepiece Adapter DK-22: The DK-22 is used when attaching the DG-2 magnifier.• Right-Angle Viewing Attachment DR-6: The DR-6 attaches at a right angle to the viewfinder eyepiece, allowing the image in the viewfinder to be viewed from above when the camera is in portrait orientation.

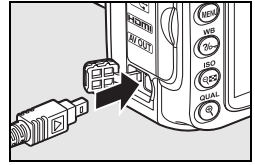


Filters	<ul style="list-style-type: none"> • Nikon filters can be divided into three types: screw-in, slip-in, and rear-interchange. Use Nikon filters; filters manufactured by other makers may interfere with autofocus or electronic range finding. • The D90 can not be used with linear polarizing filters. Use the C-PL circular polarizing filter instead. • The NC and L37C filters are recommended for protecting the lens. • To prevent moiré, use of a filter is not recommended when the subject is framed against a bright light, or when a bright light source is in the frame. • Center-weighted metering is recommended with filters with exposure factors (filter factors) over 1 × (Y44, Y48, Y52, O56, R60, X0, X1, C-PL, ND2S, ND4, ND4S, ND8, ND8S, ND400, A2, A12, B2, B8, B12).
Optional flash units (pg. 233)	<ul style="list-style-type: none"> • Nikon Speedlights SB-900, SB-800, SB-600, and SB-400 • Nikon Wireless Remote Speedlight SB-R200 • Wireless Speedlight Commander SU-800
Software	<ul style="list-style-type: none"> • Capture NX 2: A complete photo editing package. • Camera Control Pro 2: Control the camera remotely from a computer and save photographs directly to the computer hard disk. <p>Note: Use the latest versions of Nikon software. Most Nikon software offers an auto update feature when the computer is connected to the Internet.</p>
Body cap	<p>Body Cap: The body cap keeps the mirror, viewfinder screen, and low-pass filter free of dust when a lens is not in place.</p>



Accessory terminal accessories

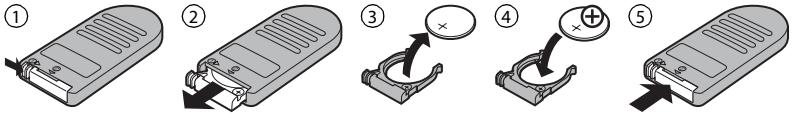
The D90 is equipped with an accessory terminal for remote cords and GPS devices. The terminal is provided with a cap, which protects the contacts when the terminal is not in use. The following accessories can be used (all lengths are approximate):



Accessory	Description
Remote Cord MC-DC2	This 1 m (3 ft. 3 in.) cord can be used to operate camera remotely, to eliminate blur caused by camera movement when shutter-release button is pressed, or to take pictures at a shutter speed of "bulb".
GPS Unit GP-1	Connect to accessory terminal to record latitude, longitude, altitude, and UTC time with pictures (pg. 124).

Remote controls

ML-L3 wireless remote control: Use as a remote shutter release for self-portraits or to prevent blur caused by camera shake. The ML-L3 uses a 3 V CR2025 battery.



■ ■ Approved Memory Cards

The following SD memory cards have been tested and approved for use in the D90. All cards of the designated make and capacity can be used, regardless of speed.

SanDisk	512MB, 1GB, 2GB*, 4GB†, 8GB†
Toshiba	512MB, 1GB, 2GB*, 4GB†, 8GB†, 16GB†, 32GB†
Panasonic	512MB, 1GB, 2GB*, 4GB†, 8GB†, 16GB†, 32GB†
Lexar Media	512MB, 1GB, 2GB*, 4GB† Platinum II: 512MB, 1GB, 2GB*, 4GB† Professional: 1GB, 2GB*, 4GB†

* If card will be used with card reader or other device, check that device supports 2GB cards.

† SDHC compliant. If card will be used with card reader or other device, check that device supports SDHC.



Other cards have not been tested. For more details on the above cards, please contact the manufacturer.

Caring for the Camera

Storage

When the camera will not be used for an extended period, replace the monitor cover, remove the battery, and store the battery in a cool, dry area with the terminal cover in place. To prevent mold or mildew, store the camera in a dry, well-ventilated area. Do not store your camera with naphtha or camphor moth balls or in locations that:

- are poorly ventilated or subject to humidities of over 60%
- are next to equipment that produces strong electromagnetic fields, such as televisions or radios
- are exposed to temperatures above 50 °C (122 °F) or below –10 °C (14 °F)

Cleaning

Camera body	Use a blower to remove dust and lint, then wipe gently with a soft, dry cloth. After using the camera at the beach or seaside, wipe off sand or salt with a cloth lightly dampened in distilled water and dry thoroughly. Important: <i>Dust or other foreign matter inside the camera may cause damage not covered under warranty.</i>
Lens, mirror, and viewfinder	These glass elements are easily damaged. Remove dust and lint with a blower. If using an aerosol blower, keep the can vertical to prevent the discharge of liquid. To remove fingerprints and other stains, apply a small amount of lens cleaner to a soft cloth and clean with care.
Monitor	Remove dust and lint with a blower. When removing fingerprints and other stains, wipe the surface lightly with a soft cloth or chamois leather. Do not apply pressure, as this could result in damage or malfunction.

Do not use alcohol, thinner, or other volatile chemicals.



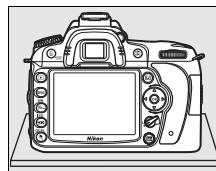
The Low-Pass Filter

The image sensor that acts as the camera's picture element is fitted with a low-pass filter to prevent moiré. If you suspect that dirt or dust on the filter is appearing in photographs, you can clean the filter using the **Clean image sensor** option in the setup menu. The filter can be cleaned at any time using the **Clean now** option, or cleaning can be performed automatically when the camera is turned on or off.

■ ■ "Clean Now"

1 Place the camera base down.

Image sensor cleaning is most effective when the camera is placed base down as shown at right.



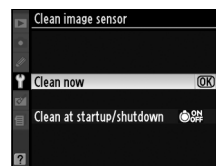
2 Display the Clean image sensor menu.

Highlight **Clean image sensor** in the setup menu and press ►.

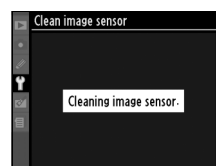


3 Select Clean now.

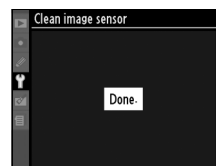
Highlight **Clean now** and press ►.



The message shown at right will be displayed while cleaning is in progress.



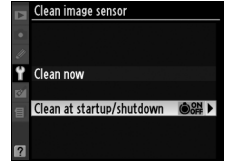
The message shown at right will be displayed when cleaning is complete.



■ “Clean at Startup/Shutdown”

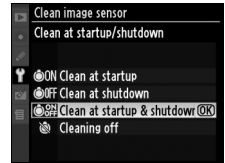
1 Select Clean at startup/shutdown.





Display the **Clean image sensor** menu as described in Step 1 on the previous page. Highlight **Clean at startup/shutdown** and press ►.



2 Select an option.

Highlight one of the following options and press **OK**.



Option	Description
 Clean at startup	The image sensor is automatically cleaned each time the camera is turned on.
 Clean at shutdown	The image sensor is automatically cleaned during shutdown each time the camera is turned off.
 Clean at startup & shutdown (default)	The image sensor is cleaned automatically at startup and at shutdown.
 Cleaning off	Automatic image sensor cleaning off.

✓ Image Sensor Cleaning

The following interrupt image sensor cleaning: raising the built-in flash, pressing the shutter-release, **Q**, depth-of-field preview, or **AF** button, using the **AE-L/AF-L** button to focus, or using the **Fn** button for FV lock.

Cleaning is performed by vibrating the image sensor. If dust can not be fully removed using the options in the **Clean image sensor** menu, clean the image sensor manually (pg. 246) or consult a Nikon-authorized service representative.


If image sensor cleaning is performed several times in succession, image sensor cleaning may be temporarily disabled to protect the camera's internal circuitry. Cleaning can be performed again after a short wait.



Manual Cleaning

If foreign matter can not be removed from the low-pass filter using the **Clean image sensor** option in the setup menu (pg. 244), the filter can be cleaned manually as described below. Note, however, that the filter is extremely delicate and easily damaged. Nikon recommends that the filter be cleaned only by Nikon-authorized service personnel.



1 Charge the battery or connect an AC adapter.

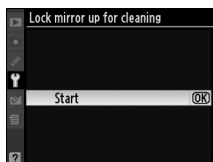
A reliable power source is required when inspecting or cleaning the low-pass filter. If the battery level is below  (60%), turn the camera off and insert a fully-charged EN-EL3e battery or connect an optional EH-5a or EH-5 AC adapter.

2 Remove the lens.

Turn the camera off and remove the lens.

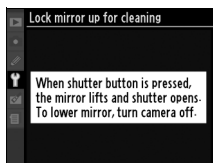
3 Select Lock mirror up for cleaning.

Turn the camera on. Highlight **Lock mirror up for cleaning** in the setup menu and press  (note that this option is not available at battery levels of  or below).



4 Press .

The message shown at right will be displayed in the monitor and a row of dashes will appear in the control panel and viewfinder. To restore normal operation without inspecting the low-pass filter, turn the camera off.



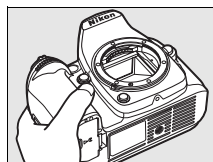
5 Raise the mirror.

Press the shutter-release button all the way down. The mirror will be raised and the shutter curtain will open, revealing the low-pass filter. The viewfinder display will turn off and the control panel display will blink.



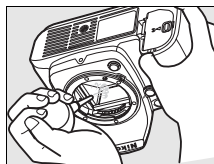
6 Examine the low-pass filter.

Holding the camera so that light falls on the low-pass filter, examine the filter for dust or lint. If no foreign objects are present, proceed to Step 8.



7 Clean the filter.

Remove any dust and lint from the filter with a blower. Do not use a blower-brush, as the bristles could damage the filter. Dirt that can not be removed with a blower can only be removed by Nikon-authorized service personnel. Under no circumstances should you touch or wipe the filter.



8 Turn the camera off.

The mirror will return to the down position and the shutter curtain will close. Replace the lens or body cap.

Use a Reliable Power Source

The shutter curtain is delicate and easily damaged. If the camera powers off while the mirror is raised, the curtain will close automatically. To prevent damage to the curtain, observe the following precautions:

- Do not turn the camera off or remove or disconnect the power source while the mirror is raised.
- If the battery runs low while the mirror is raised, a beep will sound and the self-timer lamp will blink to warn that the shutter curtain will close and the mirror will be lowered after about two minutes. End cleaning or inspection immediately.

Foreign Matter on the Low-Pass Filter

Nikon takes every possible precaution to prevent foreign matter from coming into contact with the low-pass filter during production and shipping. The D90, however, is designed to be used with interchangeable lenses, and foreign matter may enter the camera when lenses are removed or exchanged. Once inside the camera, this foreign matter may adhere to the low-pass filter, where it may appear in photographs taken under certain conditions. To protect the camera when no lens is in place, be sure to replace the body cap provided with the camera, being careful to first remove all dust and other foreign matter that may be adhering to the body cap. Avoid exchanging lenses in dusty environments.

Should foreign matter find its way onto the low-pass filter, clean the filter as described above, or have the filter cleaned by authorized Nikon service personnel. Photographs affected by the presence of foreign matter on the filter can be retouched using Capture NX 2 (available separately; pg. 240) or the clean image options available in some third-party imaging applications.

Servicing the Camera and Accessories

The camera is a precision device and requires regular servicing. Nikon recommends that the camera be inspected by the original retailer or Nikon service representative once every one to two years, and that it be serviced once every three to five years (note that fees apply to these services). Frequent inspection and servicing are particularly recommended if the camera is used professionally. Any accessories regularly used with the camera, such as lenses or optional Speedlights, should be included when the camera is inspected or serviced.



Caring for the Camera and Battery:

Cautions

Do not drop: The product may malfunction if subjected to strong shocks or vibration.

Keep dry: This product is not waterproof, and may malfunction if immersed in water or exposed to high levels of humidity. Rusting of the internal mechanism can cause irreparable damage.

Avoid sudden changes in temperature: Sudden changes in temperature, such as occur when entering or leaving a heated building on a cold day, can cause condensation inside the device. To prevent condensation, place the device in a carrying case or plastic bag before exposing it to sudden changes in temperature.

Keep away from strong magnetic fields: Do not use or store this device in the vicinity of equipment that generates strong electromagnetic radiation or magnetic fields. Strong static charges or the magnetic fields produced by equipment such as radio transmitters could interfere with the monitor, damage data stored on the memory card, or affect the product's internal circuitry.

Do not leave the lens pointed at the sun: Do not leave the lens pointed at the sun or other strong light source for an extended period. Intense light may cause the image sensor to deteriorate or produce a white blur effect in photographs.

Turn the product off before removing or disconnecting the power source: Do not unplug the product or remove the battery while the product is on or while images are being recorded or deleted. Forcibly cutting power in these circumstances could result in loss of data or in damage to product memory or internal circuitry. To prevent an accidental interruption of power, avoid carrying the product from one location to another while the AC adapter is connected.

Cleaning: When cleaning the camera body, use a blower to gently remove dust and lint, then wipe gently with a soft, dry cloth. After using the camera at the beach or seaside, wipe off any sand or salt using a cloth lightly dampened in pure water and then dry the camera thoroughly. In rare instances, static electricity may cause the LCD displays to light up or go dark. This does not indicate a malfunction, and the display will soon return to normal.

The lens and mirror are easily damaged. Dust and lint should be gently removed with a blower. When using an aerosol blower, keep the can vertical to prevent discharge of liquid. To remove fingerprints and other stains from the lens, apply a small amount of lens cleaner to a soft cloth and wipe the lens carefully.

See "The Low-Pass Filter" (pp. 244, 246) for information on cleaning the low-pass filter.

Lens contacts: Keep the lens contacts clean.

Do not touch the shutter curtain: The shutter curtain is extremely thin and easily damaged. Under no circumstances should you exert pressure on the curtain, poke it with cleaning tools, or subject it to powerful air currents from a blower. These actions could scratch, deform, or tear the curtain.

The shutter curtain may appear to be unevenly colored, but this has no effect on pictures and does not indicate a malfunction.



Storage: To prevent mold or mildew, store the camera in a dry, well-ventilated area. If the product will not be used for an extended period, remove the battery to prevent leakage and store the camera in a plastic bag containing a desiccant. Do not, however, store the camera case in a plastic bag, as this may cause the material to deteriorate. Note that desiccant gradually loses its capacity to absorb moisture and should be replaced at regular intervals.

To prevent mold or mildew, take the camera out of storage at least once a month. Turn the camera on and release the shutter a few times before putting it away.

Store the battery in a cool, dry place. Replace the terminal cover before putting the battery away.

Notes on the monitor: The monitor may contain a few pixels that are always lit or that do not light. This is common to all TFT LCD monitors and does not indicate a malfunction. Images recorded with the product are unaffected.

Images in the monitor may be difficult to see in a bright light.

Do not apply pressure to the monitor, as this could cause damage or malfunction. Dust or lint on the monitor can be removed with a blower. Stains can be removed by wiping lightly with a soft cloth or chamois leather. Should the monitor break, care should be taken to avoid injury from broken glass and to prevent liquid crystal from the monitor touching the skin or entering the eyes and mouth.

Replace the monitor cover when transporting the camera or leaving it unattended.

Batteries: Dirt on the battery terminals can prevent the camera from functioning and should be removed with a soft, dry cloth before use.

Batteries may leak or explode if improperly handled. Observe the following precautions when handling batteries:

Turn the product off before replacing the battery.

The battery may become hot when used for extended periods. Observe due caution when handling the battery.

Use only batteries approved for use in this equipment.

Do not expose the battery to flame or excessive heat.

After removing the battery from the camera, be sure to replace the terminal cover.

Charge the battery before use. When taking photographs on important occasions, ready a spare EN-EL3e battery and keep it fully charged. Depending on your location, it may be difficult to purchase replacement batteries on short notice.

On cold days, the capacity of batteries tends to decrease. Be sure the battery is fully charged before taking photographs outside in cold weather. Keep a spare battery in a warm place and exchange the two as necessary. Once warmed, a cold battery may recover some of its charge.

Continuing to charge the battery after it is fully charged can impair battery performance.

Used batteries are a valuable resource. Please recycle used batteries in accord with local regulations.



Troubleshooting

If the camera fails to function as expected, check the list of common problems below before consulting your retailer or Nikon representative. Refer to the page numbers in the right-most column for more information.

Display

Problem	Solution	Page
Viewfinder is out of focus.	Adjust viewfinder focus or use optional eyepiece correction lenses.	32
Viewfinder is dark.	Insert a fully-charged battery.	34
Displays turn off without warning.	Choose longer delays for Custom Setting c2 (Auto meter-off delay) or c4 (Monitor off delay).	179, 180
Unusual characters displayed in control panel.	See "A Note on Electronically-Controlled Cameras," below.	250
Displays in control panel or viewfinder are unresponsive and dim.	The response times and brightness of these displays varies with temperature.	—
Fine lines are visible around active focus point or display turns red when focus point is highlighted.	These phenomena are normal for this type of viewfinder and do not indicate a malfunction.	—

A Note on Electronically-Controlled Cameras

In extremely rare instances, unusual characters may appear in the control panel and the camera may stop functioning. In most cases, this phenomenon is caused by a strong external static charge. Turn the camera off, remove and replace the battery, taking care to avoid burns, and turn the camera on again, or, if you are using an AC adapter (available separately), disconnect and reconnect the adapter and turn the camera on again. In the event of continued malfunction, contact your retailer or Nikon-authorized service representative. Note that disconnecting the power source as described above may result in loss of any data not recorded to the memory card at the time the problem occurred. Data already recorded to the card will not be affected.

Shooting (All Modes)

Problem	Solution	Page
Camera takes time to turn on.	Delete files or folders.	—
Shutter-release disabled.	<ul style="list-style-type: none"> Memory card is full or not inserted. 	29, 35
	<ul style="list-style-type: none"> CPU lens with aperture ring attached but aperture not locked at highest f-number. 	25
	<ul style="list-style-type: none"> Mode dial rotated to S with shutter speed set to 1/4000. 	83
Final photo is larger than area shown in viewfinder.	Viewfinder horizontal and vertical frame coverage is approximately 95%.	—
Photos are out of focus.	<ul style="list-style-type: none"> Rotate focus-mode selector to AF. 	54
	<ul style="list-style-type: none"> Camera unable to focus using autofocus: use manual focus or focus lock. 	57, 59
Focus does not lock when shutter-release button is pressed halfway.	Use AE-L/AF-L button to lock focus when AF-C autofocus mode is selected or when photographing moving subjects in AF-A mode.	54
Image size can not be changed.	Image quality set to NEF (RAW) .	62
Can not select focus point	<ul style="list-style-type: none"> Unlock focus selector lock. 	56
	<ul style="list-style-type: none"> Auto-area selected for AF-area mode: choose another mode. 	173
	<ul style="list-style-type: none"> Press shutter-release button halfway to turn monitor off or activate exposure meters. 	35
Camera is slow to record photos.	Turn long exposure noise reduction off.	167
Randomly-spaced bright pixels (“noise”) appear in photos.	<ul style="list-style-type: none"> Choose lower ISO sensitivity or turn high ISO noise reduction on. 	74, 167
	<ul style="list-style-type: none"> Shutter speed is slower than 8 s: use long exposure noise reduction. 	167
AF-assist illuminator does not light.	<ul style="list-style-type: none"> Mode dial rotated to M or S: select another mode. 	41
	<ul style="list-style-type: none"> AF-assist lamp does not light for continuous-servo autofocus. Choose AF-S. In single-point, dynamic-area, or 3D-tracking AF, select center focus point. 	54
	<ul style="list-style-type: none"> Off selected for Custom Setting a3 (Built-in AF-assist illuminator). 	174
	<ul style="list-style-type: none"> Illuminator has turned off automatically. Illuminator may become hot with continued use; wait for lamp to cool down. 	—
No photo taken when remote control shutter-release button is pressed.	<ul style="list-style-type: none"> Replace battery in remote control. 	241
	<ul style="list-style-type: none"> Choose remote control mode. 	68
	<ul style="list-style-type: none"> Flash is charging. 	40
	<ul style="list-style-type: none"> Time selected for Custom Setting c5 (Remote on duration) has passed: reselect remote control mode. 	180
	<ul style="list-style-type: none"> Bright light is interfering with remote. 	—
Photos are blotched or smeared.	<ul style="list-style-type: none"> Clean lens. 	—
	<ul style="list-style-type: none"> Clean low-pass filter. 	244



Shooting (AUTO, , , , , , , and modes)

Problem	Solution	Page
Menu item can not be selected.	Some options are not available in all modes.	—

Shooting (P, S, A, M)

Problem	Solution	Page
Shutter-release disabled.	• Flash is charging.	40
	• Non-CPU lens is attached: rotate camera mode dial to M .	83
	• Mode dial rotated to S after shutter speed of b w l b or - - selected in mode M : choose new shutter speed.	81
Full range of shutter speeds not available.	Flash in use. If On is selected for Custom Setting e5 (Auto FP) in modes P , S , A , and M , optional SB-900, SB-800, SB-600, and SB-R200 flash units can be used at all shutter speeds.	195
Colors are unnatural.	• Adjust white balance to match light source.	95
	• Adjust Set Picture Control settings.	108
Can not measure white balance.	Subject is too dark or too bright.	102
Image can not be selected as source for preset white balance.	Image was not created with D90.	104
White balance bracketing unavailable.	• NEF (RAW) or NEF+JPEG image quality option selected for image quality.	62
	• Multiple exposure mode is in effect.	121
Effects of Picture Control differ from image to image.	A (auto) is selected for sharpening, contrast, or saturation. For consistent results over a series of photographs, choose a setting other than A (auto).	111
Metering can not be changed.	Autoexposure lock is in effect.	88
Exposure compensation can not be used.	Choose exposure mode P , S , or A .	90
Only one shot taken each time shutter-release button is pressed in continuous shooting mode.	Lower built-in flash.	73
Reddish areas appear in photos.	Reddish areas and uneven textures may appear in long time-exposures. Turn long exposure noise reduction on when shooting at shutter speeds of b w l b .	167
Textures are uneven.		



Playback

Problem	Solution	Page
Flashing areas appear in images	Press ▲ or ▼ to choose photo information displayed, or change settings for Display mode .	129, 163
Shooting data appear on images		
A graph appears during playback.		
NEF (RAW) image is not played back.	Photo was taken at image quality of NEF + JPEG.	62
Some photos are not displayed during playback.	Select All for Playback folder . Note that Current is automatically selected after photograph is taken.	162
“Tall” (portrait) orientation photos are displayed in “wide” (landscape) orientation.	• Select On for Rotate tall .	163
	• Photo was taken with Off selected for Auto image rotation .	205
	• Camera orientation was changed while shutter-release button was pressed in continuous release mode.	84
	• Photo is displayed in image review.	128
	• Camera was pointed up or down when photo was taken.	205
Can not delete photo.	Photo is protected: remove protection. Memory card is locked.	139
Message is displayed stating that no images are available for playback.	Select All for Playback folder . Note that Current is automatically selected after photograph is taken.	162
Can not change print order.	Memory card is full: delete photos. Memory card is locked.	35
Can not select photo for printing.	Photo is in NEF (RAW) format. Create JPEG copy using NEF (RAW) processing or transfer to computer and print using supplied software or Capture NX 2.	150
Photo is not displayed on TV.	Choose correct video mode.	203
Photo is not displayed on high-definition video device.	Confirm that HDMI cable (available separately) is connected.	147
NEF (RAW) photos not displayed in Capture NX.	Update to Capture NX 2.	240
Image Dust Off option in Capture NX 2 does not have desired effect.	Image sensor cleaning changes the position of dust on the low-pass filter. Dust off reference data recorded before image sensor cleaning is performed can not be used with photographs taken after image sensor cleaning is performed. Dust off reference data recorded after image sensor cleaning is performed can not be used with photographs taken before image sensor cleaning is performed.	206



Miscellaneous



Problem	Solution	Page
Date of recording is not correct.	Set camera clock.	27
Menu item can not be selected.	Some options are not available at certain combinations of settings or when no memory card is inserted. Note that Battery info option is not available when camera is powered by an optional AC adapter.	208





Error Messages

This section lists the indicators and error messages that appear in the viewfinder, control panel, and monitor.

Indicator		Problem	Solution	Page
Control panel	Viewfinder			
F E E (blinks)		Lens aperture ring is not set to minimum aperture.	Set ring to minimum aperture (largest f-number).	26
		Low battery.	Ready a fully-charged spare battery.	34
 (blinks)	 (blinks)	<ul style="list-style-type: none"> Battery exhausted. Battery can not be used. An extremely exhausted rechargeable Li-ion battery or a third-party battery is inserted either in the camera or in the optional MB-D80 battery pack. 	<ul style="list-style-type: none"> Recharge or replace battery. Use Nikon-approved battery, or contact Nikon-authorized service representative. Replace the battery, or recharge the battery if the rechargeable Li-ion battery is exhausted. 	xviii, 22, 23
 (blinks)	—	Camera clock is not set.	Set camera clock.	27
F - - (blinks)		<ul style="list-style-type: none"> No lens attached. Non-CPU lens attached. 	<ul style="list-style-type: none"> Attach non-IX Nikkor lens. Select mode M. 	230
—	 (blinks)	Camera unable to focus using autofocus.	Focus manually.	59
		Subject too bright; photo will be overexposed.	<ul style="list-style-type: none"> Use a lower ISO sensitivity Use optional ND filter In exposure mode: <ul style="list-style-type: none"> S Increase shutter speed A Choose a smaller aperture (larger f-number) 	74 240 81 82
		Subject too dark; photo will be underexposed.	<ul style="list-style-type: none"> Use a higher ISO sensitivity Use flash In exposure mode: <ul style="list-style-type: none"> S Lower shutter speed A Choose a larger aperture (smaller f-number) 	74 70 81 82
 (blinks)		selected in exposure mode S .	Change shutter speed or select manual exposure mode.	81, 83
- - (blinks)		- - selected in exposure mode S .	Change shutter speed or select manual exposure mode.	81, 83
 (blinks)	 (blinks)	Optional flash unit that does not support i-TTL flash control attached and set to TTL.	Change flash mode setting on optional flash unit.	236

Indicator		Problem	Solution	Page
Control panel	Viewfinder			
—	 (blinks)	If indicator blinks for 3 s after flash fires, photo may be underexposed.	Check photo in monitor; if underexposed, adjust settings and try again.	128
FuLL (blinks)	FuLL (blinks)	Memory insufficient to record further photos at current settings, or camera has run out of file or folder numbers.	<ul style="list-style-type: none"> • Reduce quality or size. • Delete photographs. • Insert new memory card. 	62, 63 162 29
{-E-}	 {-E-}	No memory card.	Insert memory card.	29
Err (blinks)		Camera malfunction.	Release shutter. If error persists or appears frequently, consult Nikon-authorized service representative.	—

Indicator		Problem	Solution	Page
Monitor	Control panel/ viewfinder			
No memory card.	{-E-}/  {-E-}	Camera cannot detect memory card.	Turn camera off and confirm that card is correctly inserted.	29
This memory card cannot be used. Card may be damaged. Insert another card.	ERR , () (blinks)	Error accessing memory card.	<ul style="list-style-type: none"> • Use approved card. • Check that contacts are clean. If card is damaged, contact retailer or Nikon representative. 	242 —
		Unable to create new folder.	Delete files or insert new memory card.	29, 162
This card is not formatted. Format the card.	For (blinks)	Memory card has not been formatted for use in camera.	Format memory card or insert new memory card.	29, 30
Folder contains no images.	—	No images on memory card or in folder(s) selected for playback.	Select folder containing images from Playback folder menu or insert different memory card.	29, 162
All images are hidden.	—	All photos in current folder are hidden.	No images can be played back until another folder has been selected or Hide image used to allow at least one image to be displayed.	162
File does not contain image data.	—	File has been created or modified using a computer or different make of camera, or file is corrupt.	File can not be played back on camera.	—

Indicator		Problem	Solution	Page
Monitor	Control panel/ viewfinder			
Memory card is locked. Slide lock to “write” position.	Σ H A, ([]) (blinks)	Memory card is locked (write protected).	Slide card write-protect switch to “write” position.	31
Cannot select this file.	—	Memory card does not contain images that can be retouched.	Images created with other devices can not be retouched.	209
No images for retouching.	—	Memory card does not contain NEF (RAW) images.	Take NEF (RAW) photographs.	62
Check printer.	—	Printer error.	Check printer. To resume, select Continue (if available).	150 *
Check paper.	—	Paper in printer is not of selected size.	Insert paper of correct size and select Continue .	150 *
Paper jam.	—	Paper is jammed in printer.	Clear jam and select Continue .	150 *
Out of paper.	—	Printer is out of paper.	Insert paper of selected size and select Continue .	150 *
Check ink supply.	—	Ink error.	Check ink. To resume, select Continue .	150 *
Out of ink.	—	Printer is out of ink.	Replace ink and select Continue .	150 *

* See printer manual for more information.












Appendix

The Appendix covers the following topics:

- Available Settings and Defaults..... 258
- Memory Card Capacity 262
- Exposure Program 263
- Bracketing Programs 264
- Flash Control..... 265
- Shutter Speeds Available with the Built-in Flash..... 265
- Aperture, Sensitivity, and Flash Range..... 266

Available Settings and Defaults

The following table lists the settings that can be adjusted in each mode:

										
Set Picture Control							✓	✓	✓	✓
Image quality ¹	✓	✓	✓	✓	✓	✓	✓	✓	✓	✓
Image size ¹	✓	✓	✓	✓	✓	✓	✓	✓	✓	✓
White balance ¹							✓	✓	✓	✓
ISO sensitivity settings ¹	✓	✓	✓	✓	✓	✓	✓	✓	✓	✓
Active D-Lighting							✓	✓	✓	✓
Color space	✓	✓	✓	✓	✓	✓	✓	✓	✓	✓
Long exp. NR	✓	✓	✓	✓	✓	✓	✓	✓	✓	✓
High ISO NR	✓	✓	✓	✓	✓	✓	✓	✓	✓	✓
Active folder	✓	✓	✓	✓	✓	✓	✓	✓	✓	✓
Multiple exposure ¹							✓	✓	✓	✓
Movie setting	✓	✓	✓	✓	✓	✓	✓	✓	✓	✓
Shooting mode ¹	✓	✓	✓	✓	✓	✓	✓	✓	✓	✓
Autofocus mode ¹	✓ ²	✓ ²	✓ ²	✓ ²	✓ ²	✓ ²	✓ ²	✓	✓	✓
Metering ¹							✓	✓	✓	✓
Flexible program ¹							✓			
Autoexposure lock ¹	✓	✓	✓	✓	✓	✓	✓	✓	✓	✓
Exposure compensation ¹							✓	✓	✓	✓
Bracketing ¹							✓	✓	✓	✓
Flash mode ¹	✓ ²		✓ ²	✓ ^{2,3}	✓ ^{2,3}	✓ ²	✓ ²	✓	✓	✓
Metering ¹							✓	✓	✓	✓
a1: AF-area mode	✓ ²	✓ ²	✓ ²	✓ ²	✓ ²	✓ ²	✓ ²	✓	✓	✓
a2: Center focus point	✓	✓	✓	✓	✓	✓	✓	✓	✓	✓
a3: Built-in AF-assist illuminator	✓	✓	✓			✓	✓	✓	✓	✓
a4: AF point illumination	✓		✓		✓		✓	✓	✓	✓
a5: Focus point wrap-around	✓	✓	✓	✓	✓	✓	✓	✓	✓	✓
a6: AE-L/AF-L for MB-D80	✓	✓	✓	✓	✓	✓	✓	✓	✓	✓
a7: Live view autofocus ¹	✓ ²	✓ ²	✓ ²	✓ ²	✓ ²	✓ ²	✓ ²	✓	✓	✓

	AUTO							P	S	A	M
b1: EV steps for exposure cntrl.	✓	✓	✓	✓	✓	✓	✓	✓	✓	✓	✓
b2: Easy exposure compensation								✓	✓	✓	✓
b3: Center-weighted area								✓	✓	✓	✓
b4: Fine tune optimal exposure	✓	✓	✓	✓	✓	✓	✓	✓	✓	✓	✓
c1: Shutter-release button AE-L	✓	✓	✓	✓	✓	✓	✓	✓	✓	✓	✓
c2: Auto meter-off delay	✓	✓	✓	✓	✓	✓	✓	✓	✓	✓	✓
c3: Self-timer	✓	✓	✓	✓	✓	✓	✓	✓	✓	✓	✓
c4: Monitor off delay	✓	✓	✓	✓	✓	✓	✓	✓	✓	✓	✓
c5: Remote on duration	✓	✓	✓	✓	✓	✓	✓	✓	✓	✓	✓
d1: Beep	✓	✓	✓	✓	✓	✓	✓	✓	✓	✓	✓
d2: Viewfinder grid display	✓	✓	✓	✓	✓	✓	✓	✓	✓	✓	✓
d3: ISO display and adjustment	✓	✓	✓	✓	✓	✓	✓	✓	✓	✓	✓
d4: Viewfinder warning display	✓	✓	✓	✓	✓	✓	✓	✓	✓	✓	✓
d5: Screen tips	✓	✓	✓	✓	✓	✓	✓	✓	✓	✓	✓
d6: CL mode shooting speed	✓	✓	✓	✓	✓	✓	✓	✓	✓	✓	✓
d7: File number sequence	✓	✓	✓	✓	✓	✓	✓	✓	✓	✓	✓
d8: Shooting info display	✓	✓	✓	✓	✓	✓	✓	✓	✓	✓	✓
d9: LCD illumination	✓	✓	✓	✓	✓	✓	✓	✓	✓	✓	✓
d10: Exposure delay mode	✓	✓	✓	✓	✓	✓	✓	✓	✓	✓	✓
d11: Flash warning								✓	✓	✓	✓
d12: MB-D80 battery type	✓	✓	✓	✓	✓	✓	✓	✓	✓	✓	✓
e1: Flash shutter speed								✓	✓	✓	✓
e2: Flash cntrl for built-in flash								✓	✓	✓	✓
e3: Modeling flash								✓	✓	✓	✓
e4: Auto bracketing set								✓	✓	✓	✓
e5: Auto FP								✓	✓	✓	✓
e6: Bracketing order								✓	✓	✓	✓
f1: switch	✓	✓	✓	✓	✓	✓	✓	✓	✓	✓	✓
f2: OK button (shooting mode)	✓	✓	✓	✓	✓	✓	✓	✓	✓	✓	✓
f3: Assign FUNC. button	✓	✓	✓	✓	✓	✓	✓	✓	✓	✓	✓
f4: Assign AE-L/AF-L button	✓	✓	✓	✓	✓	✓	✓	✓	✓	✓	✓
f5: Customize command dials	✓	✓	✓	✓	✓	✓	✓	✓	✓	✓	✓
f6: No memory card?	✓	✓	✓	✓	✓	✓	✓	✓	✓	✓	✓
f7: Reverse indicators	✓	✓	✓	✓	✓	✓	✓	✓	✓	✓	✓

Custom settings⁴




- 1 Reset with two-button reset (pg. 75).
- 2 Reset with when mode dial is rotated to new setting.
- 3 Available with optional flash units only.
- 4 Reset with Custom Setting (**Reset Custom Settings**).



The following defaults are restored with Custom Setting **Ⓜ** (**Reset Custom Settings**; the following table lists the defaults for **P**, **S**, **A**, and **M** modes). For a list of the settings restored with a two-button reset, see page 172.

Option	Default
a1: AF-area mode	Auto-area
a2: Center focus point	Normal zone
a3: Built-in AF-assist illuminator	On
a4: AF point illumination	Auto
a5: Focus point wrap-around	No wrap
a6: AE-L/AF-L for MB-D80	AE/AF lock
a7: Live view autofocus	Wide area
b1: EV steps for exposure cntrl.	1/3 step
b2: Easy exposure compensation	Off
b3: Center-weighted area	φ 8 mm
b4: Fine tune optimal exposure	No
c1: Shutter-release button AE-L	Off
c2: Auto meter-off delay	6 s
c3: Self-timer	
Self-timer delay	10 s
Number of shots	1
c4: Monitor off delay	
Playback	10 s
Menus	20 s
Shooting info display	10 s
Image review	4 s
c5: Remote on duration	1 min
d1: Beep	On
d2: Viewfinder grid display	Off
d3: ISO display and adjustment	Show frame count
d4: Viewfinder warning display	On
d5: Screen tips	On
d6: CL mode shooting speed	3 fps
d7: File number sequence	Off
d8: Shooting info display	Auto
d9: LCD illumination	Off
d10: Exposure delay mode	Off
d11: Flash warning	On
d12: MB-D80 battery type	LR6 (AA alkaline)



Option	Default
e1: Flash shutter speed	1/60 s
e2: Flash cntrl for built-in flash	TTL
e3: Modeling flash	Off
e4: Auto bracketing set	AE & flash
e5: Auto FP	Off
e6: Bracketing order	MTR > under > over
f1:  switch	LCD backlight ()
f2: OK button (shooting mode)	Select center focus point
f3: Assign FUNC. button	FV lock
f4: Assign AE-L/AF-L button	AE/AF lock
f5: Customize command dials	
Reverse rotation	No
Change main/sub	Off
Menus and playback	On
f6: No memory card?	Release locked
f7: Reverse indicators	



Memory Card Capacity

The following table shows the approximate number of pictures that can be stored on a 2 GB Panasonic Pro HIGH SPEED card at different image quality and size settings.

Image quality	Image size	File size ¹	No. of images ¹	Buffer capacity ²
NEF + JPEG fine ³	L	16.9 MB	89	7
	M	14.4 MB	104	7
	S	12.4 MB	118	7
NEF + JPEG normal ³	L	13.9 MB	106	7
	M	12.6 MB	116	7
	S	11.6 MB	124	7
NEF + JPEG basic ³	L	12.3 MB	118	7
	M	11.7 MB	123	7
	S	11.2 MB	128	7
NEF (RAW)	—	10.8 MB	133	9
JPEG fine	L	6.0 MB	271	25
	M	3.4 MB	480	100
	S	1.6 MB	1000	100
JPEG normal	L	3.0 MB	539	100
	M	1.7 MB	931	100
	S	0.8 MB	2000	100
JPEG basic	L	1.5 MB	1000	100
	M	0.9 MB	1800	100
	S	0.4 MB	3800	100

¹ All figures are approximate. File size varies with scene recorded.

² Maximum number of exposures that can be stored in memory buffer. Drops if ISO sensitivity is set to ∞ or higher, **High ISO NR** is on when ISO sensitivity is set to 800 or higher, or long exposure noise reduction or Active D-lighting is on.

³ Image size applies to JPEG images only. Size of NEF (RAW) images can not be changed. File size is the total for NEF (RAW) and JPEG images.

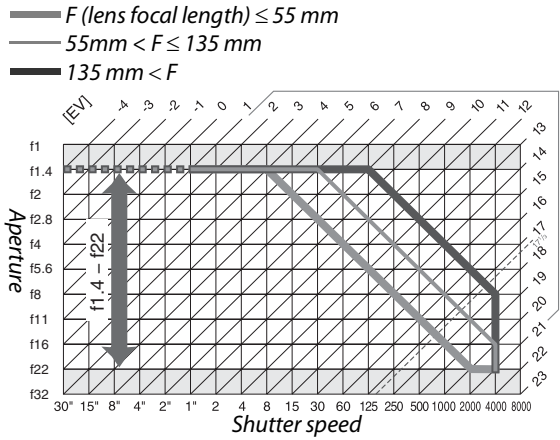
Custom Setting d6: CL mode shooting speed (pg. 182)

The maximum number of photographs that can be taken in a single burst can be set to any amount between 1 and 4.



Exposure Program

The exposure program for programmed auto is shown in the following graph:

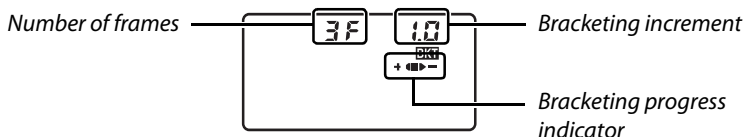


The maximum and minimum values for EV vary with ISO sensitivity; the above graph assumes an ISO sensitivity of ISO 200 equivalent. When matrix metering is used, values over $17\frac{1}{3}$ EV are reduced to $17\frac{1}{3}$ EV.



Bracketing Programs

The number of shots and bracketing increment are shown in the control panel as follows:



■ ■ The Bracketing Progress Indicator and Number of Frames

Number of frames	Progress indicator	Description
3F	+◀■▶-	3 frames: unmodified, negative, positive *
+2F	+◀■	2 frames: unmodified, positive
--2F	■▶-	2 frames: unmodified, negative *

* Order when **Under > MTR > over** is selected for Custom Setting e6 (**Bracketing order**) is negative, unmodified, positive (three frames) or negative, unmodified (two frames).

■ ■ Bracketing Increment

Autoexposure and flash bracketing				White balance bracketing	
"EV steps for exposure cntrl." set to 1/3 EV		"EV steps for exposure cntrl." set to 1/2 EV		Display	Increment
Display	Increment	Display	Increment		
0.3	1/3EV	0.5	1/2EV	1	1
0.7	2/3EV	1.0	1EV	2	2
1.0	1EV	1.5	1 1/2EV	3	3
1.3	1 1/3EV	2.0	2EV		
1.7	1 2/3EV				
2.0	2EV				

Flash Control


The following types of flash control are supported when a CPU lens is used in combination with the built-in flash or optional SB-900, SB-800, or SB-600 flash units (pp. 73, 234).

- **i-TTL Balanced Fill-Flash for Digital SLR:** Flash output is adjusted for a natural balance between the main subject and the background.
- **Standard i-TTL Fill-Flash for Digital SLR:** Flash output is adjusted for the main subject; the brightness of the background is not taken into account. Recommended for shots in which the main subject is emphasized at the expense of background details, or when exposure compensation is used.

Standard i-TTL flash control is used with spot metering or when selected with the optional flash unit. i-TTL balanced fill-flash for digital SLR is used in all other cases.

Shutter Speeds Available with the Built-in Flash

The following shutter speeds are available with the built-in flash when vibration reduction (VR) is not used.

Mode	Shutter speed	Mode	Shutter speed
AUTO,  , P *, A *	1/200–1/60 s		1/200–1 s
	1/200–1/125 s	S, M	1/200–30 s

* Slowest shutter speed at which flash will be used can be selected using Custom Setting e1 (**Flash shutter speed**). Flash will still fire at shutter speeds as slow as 30 s when set to slow sync.








Aperture, Sensitivity, and Flash Range

Flash range varies with sensitivity (ISO equivalency) and aperture.

Aperture at ISO equivalent of					Range	
200	400	800	1600	3200	m	ft.
1.4	2	2.8	4	5.6	1.0–8.5	3 ft. 3 in.–27 ft. 11 in.
2	2.8	4	5.6	8	0.7–6.1	2 ft. 4 in.–20 ft.
2.8	4	5.6	8	11	0.6–4.2	2 ft.–13 ft. 9 in.
4	5.6	8	11	16	0.6–3.0	2 ft.–9 ft. 10 in.
5.6	8	11	16	22	0.6–2.1	2 ft.–6 ft. 11 in.
8	11	16	22	32	0.6–1.5	2 ft.–4 ft. 11 in.
11	16	22	32	—	0.6–1.1	2 ft.–3 ft. 7 in.
16	22	32	—	—	0.6–0.8	2 ft.–2 ft. 7 in.

In the following modes, the maximum aperture (minimum f-number) is limited according to ISO sensitivity when the built-in flash is used:

Mode	Maximum aperture at ISO sensitivity of				
	200	400	800	1600	3200
P,  ,  ,  , 	2.8	3.3	4	4.8	5.6
	5.6	6.7	8	9.5	11
















For each one-step increase in sensitivity (e.g., from 200 to 400), aperture is stopped down by half an f/-stop. If the maximum aperture of the lens is smaller than given above, the maximum value for aperture will be the maximum aperture of the lens.

Specifications

■ Nikon D90 Digital Camera

Type	
Type	Single-lens reflex digital camera
Lens mount	Nikon F mount (with AF coupling and AF contacts)
Effective picture angle	Approx. $1.5 \times$ lens focal length (Nikon DX format)
Effective pixels	
Effective pixels	12.3 million
Image sensor	
Image sensor	23.6 × 15.8 mm CMOS sensor
Total pixels	12.9 million
Dust-reduction System	Image sensor cleaning, Image Dust Off reference data (optional Capture NX 2 software required)
Storage	
Image size (pixels)	<ul style="list-style-type: none">• 4,288 × 2,848 (L)• 2,144 × 1,424 (S)• 3,216 × 2,136 (M)
File format	<ul style="list-style-type: none">• NEF (RAW)• JPEG: JPEG-Baseline compliant with fine (approx. 1 : 4), normal (approx. 1 : 8), or basic (approx. 1 : 16) compression• NEF (RAW)+JPEG: Single photograph recorded in both NEF (RAW) and JPEG formats
Picture Control System	Can be selected from Standard, Neutral, Vivid, Monochrome, Landscape, Portrait; storage for up to nine custom Picture Controls
Media	SD (Secure Digital) memory cards, SDHC-compliant
File system	DCF (Design Rule for Camera File System) 2.0, DPOF (Digital Print Order Format), Exif 2.21 (Exchangeable Image File Format for Digital Still Cameras), PictBridge
Viewfinder	
Viewfinder	Eye-level pentaprism single-lens reflex viewfinder
Frame coverage	Approx. 96% horizontal and 96% vertical
Magnification	Approx. $0.94 \times$ (50 mm f/1.4 lens at infinity, -1.0 m^{-1})
Eyepoint	19.5 mm (-1.0 m^{-1})
Diopter adjustment	-2 – $+1 \text{ m}^{-1}$
Focusing screen	Type B BriteView Clear Matte Mark II screen with focus frame (framing grid can be displayed)
Reflex mirror	Quick return
Depth-of-field preview	When depth-of-field preview button is pressed, lens aperture is stopped down to value selected by user (A and M modes) or by camera (other modes)
Lens aperture	Instant return, electronically controlled







Lens	
Compatible lenses	<ul style="list-style-type: none"> • DX AF Nikkor: All functions supported • Type G or D AF Nikkor: All functions supported (PC Micro-Nikkor does not support some functions). IX Nikkor lenses not supported. • Other AF Nikkor: All functions supported except 3D color matrix metering II. Lenses for F3AF not supported. • AI-P Nikkor: All functions supported except 3D color matrix metering II • Non-CPU: Autofocus not supported. Can be used in exposure mode M, but exposure meter does not function. Electronic rangefinder can be used if lens has a maximum aperture of f/5.6 or faster.
Shutter	
Type	Electronically-controlled vertical-travel focal-plane shutter
Speed	$1/4000$ – 30 s in steps of $1/3$ or $1/2$ EV, bulb
Flash sync speed	X = $1/200$ s; synchronizes with shutter at $1/200$ s or slower
Release	
Release mode	 (single frame),  L (continuous low speed),  H (continuous high speed),  (self-timer),  (delayed remote),  (quick response)
Frame advance rate	 H : Up to 4.5 fps  L : 1 fps–4 fps
Self-timer	Can be selected from 2, 5, 10, and 20 s duration
Exposure	
Metering	TTL exposure metering using 420-segment RGB sensor
Metering method	<ul style="list-style-type: none"> • Matrix: 3D color matrix metering II (type G and D lenses); color matrix metering II (other CPU lenses) • Center-weighted: Weight of 75% given to 6, 8, or 10-mm circle in center of frame • Spot: Meters 3.5-mm circle (about 2% of frame) centered on selected focus point
Range (ISO 100, f/1.4 lens, 20 °C/68 °F)	<ul style="list-style-type: none"> • Matrix or center-weighted metering: 0–20 EV • Spot metering: 2–20 EV
Exposure meter coupling	CPU
Mode	Auto modes ( auto;  auto (flash off)); scene modes ( portrait;  landscape;  close-up;  sports;  night portrait); programmed auto with flexible program (P); shutter-priority auto (S); aperture-priority auto (A); manual (M)
Exposure compensation	–5 – +5 EV in increments of $1/3$ or $1/2$ EV
Exposure bracketing	2 or 3 frames in steps of $1/3$, $1/2$, $2/3$, 1, or 2 EV
Flash bracketing	2 or 3 frames in steps of $1/3$, $1/2$, $2/3$, 1, or 2 EV
White balance bracketing	2 or 3 frames in steps of 1, 2, or 3
ADL bracketing	2 frames
Exposure lock	Luminosity locked at detected value with AE-L/AF-L button



Exposure	
ISO sensitivity (Recommended Exposure Index)	ISO 200 – 3200 in steps of $\frac{1}{3}$ EV. Can also be set to approx. 0.3, 0.7, or 1 EV (ISO 100 equivalent) below ISO 200 or to approx. 0.3, 0.7, or 1 EV (ISO 6400 equivalent) above ISO 3200.
Active D-Lighting	Can be selected from Auto, Extra high, High, Normal, Low, or Off
Focus	
Autofocus	Nikon Multi-CAM 1000 autofocus module with TTL phase detection, 11 focus points (including one cross-type sensor), and AF-assist illuminator (range approx. 0.5–3 m/1 ft. 8 in.–9 ft. 10 in.)
Detection range	–1 – +19 EV (ISO 100, 20 °C/68 °F)
Lens servo	<ul style="list-style-type: none"> • Autofocus (AF): Instant single-servo AF (AF-S); continuous-servo AF (AF-C); auto AF-S/AF-C selection (AF-A); predictive focus tracking activated automatically according to subject status • Manual (M): Electronic rangefinder can be used
Focus point	Can be selected from 11 focus points
AF-area mode	Single-point, dynamic-area, auto-area, 3D-tracking (11 points)
Focus lock	Focus can be locked by pressing shutter-release button halfway (single-servo AF) or by pressing AE-L/AF-L button



Flash	
Built-in flash	 : Auto flash with auto pop-up P, S, A, M : Manual pop-up with button release
Guide Number (m/ft) at 20 °C/(68 °F)	<ul style="list-style-type: none"> • At ISO 200: Approx. 17/56, 18/59 with manual flash • At ISO 100: Approx. 12/39, 13/43 with manual flash
Flash control	<ul style="list-style-type: none"> • TTL: i-TTL balanced fill-flash and standard i-TTL flash for digital SLR using 420-segment RGB sensor are available with built-in flash and SB-900, SB-800, SB-600, or SB-400 • Auto aperture: Available with SB-900, SB-800 and CPU lens • Non-TTL auto: Supported flash units include SB-900, SB-800, SB-28, SB-27, and SB-22s • Range-priority manual: Available with SB-900 and SB-800
Flash mode	<ul style="list-style-type: none"> •  : Auto, auto with red-eye reduction; fill-flash and red-eye reduction available with optional flash units •  : Auto slow sync, auto slow sync with red-eye reduction; slow sync and slow sync with red-eye reduction available with optional flash units •  : Fill-flash and red-eye reduction available with optional flash units • P, A: Fill-flash, rear-curtain with slow sync, auto slow sync, slow sync with red-eye reduction, red-eye reduction • S, M: Fill-flash, rear-curtain sync, red-eye reduction
Flash compensation	-3 – +1 EV in increments of 1/3 or 1/2 EV
Flash-ready indicator	Lights when built-in flash or optional flash unit such as SB-900, SB-800, SB-600, SB-400, SB-80DX, SB-28DX, or SB-50DX is fully charged; blinks for 3 s after flash is fired at full output in i-TTL or auto aperture modes
Accessory shoe	Standard ISO 518 hot-shoe contact with safety lock
Nikon Creative Lighting System (CLS)	Advanced Wireless Lighting supported with built-in flash, SB-900, SB-800, or SU-800 as commander and SB-900, SB-800, SB-600, or SB-R200 as remotes; Auto FP High-Speed Sync and modeling illumination supported with all CLS-compatible flash units except SB-400; Flash Color Information Communication and FV lock supported with all CLS-compatible flash units
White balance	
White balance	Auto (TTL white-balance with main image sensor and 420 segment RGB sensor); 12 manual modes with fine-tuning; color temperature setting; preset white balance; white balance bracketing
Live view	
AF modes	Face-priority, wide area, normal area
Autofocus	Contrast-detect AF anywhere in frame (camera selects focus point automatically when face-priority AF is selected)



Movie	
Image size (pixels)	<ul style="list-style-type: none"> • 1,280 × 720/24 fps • 320 × 216/24 fps • 640 × 424/24 fps
File format	AVI
Compression	Motion-JPEG
Monitor	
Monitor	3-in., approx. 920k-dot (VGA), low-temperature polysilicon TFT LCD with 170 ° viewing angle, approx. 100% frame coverage, and brightness adjustment
Playback	
Playback	Full-frame and thumbnail (4, 9, or 72 images or calendar) playback with playback zoom, movie playback, Pictmotion, slide show, histogram display, highlights, auto image rotation, and image comment (up to 36 characters)
Interface	
USB	Hi-Speed USB
Video output	Can be selected from NTSC and PAL; images can be displayed on external device while camera monitor is on
HDMI output	Type C HDMI connector; camera monitor turns off when HDMI cable is connected.
Accessory terminal	Remote cord: MC-DC2 (available separately) GPS unit: GP-1 (available separately)
Supported languages	
Supported languages	Chinese (Simplified and Traditional), Danish, Dutch, English, Finnish, French, German, Italian, Japanese, Korean, Norwegian, Polish, Portuguese, Russian, Spanish, Swedish



Power source	
Battery	One rechargeable Li-ion EN-EL3e battery
Battery pack	Optional MB-D80 multi-power battery pack with one or two rechargeable Nikon EN-EL3e batteries or six AA alkaline, NiMH, lithium, or nickel-manganese batteries; AA batteries (available separately); optional MS-D200 battery holder is required when using AA batteries.
AC adapter	EH-5a or EH-5 AC adapter (available separately)

Tripod socket	
Tripod socket	1/4 in. (ISO 1222)

Dimensions/weight	
Dimensions (W × H × D)	Approx. 132 × 103 × 77 mm (5.2 × 4.1 × 3.0 in.)
Weight	Approx. 620 g (1 lb. 6 oz.) without battery, memory card, body cap, or monitor cover

Operating environment	
Temperature	0–40 °C (32–104 °F)
Humidity	Less than 85% (no condensation)

- Unless otherwise stated, all figures are for a camera with a fully-charged battery operating at an ambient temperature of 20 °C (68 °F).
- Nikon reserves the right to change the specifications of the hardware and software described in this manual at any time and without prior notice. Nikon will not be held liable for damages that may result from any mistakes that this manual may contain.

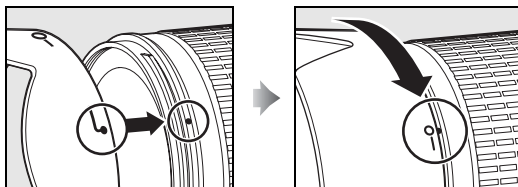
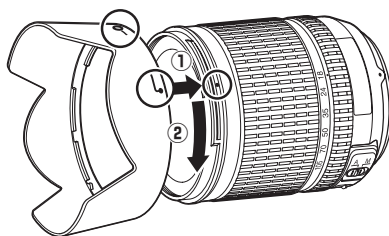
MH-18a quick charger	
Rated input	AC 100–240 V (50/60 Hz)
Rated output	DC 8.4 V/900 mA
Supported batteries	Nikon EN-EL3e rechargeable Li-ion battery
Charging time	Approx. 2 hours and 15 minutes when battery is fully discharged
Operating temperature	0–40 °C (+32–104 °F)
Dimensions (W × H × D)	Approx. 90 × 35 × 58 mm (3.5 × 1.4 × 2.3 in.)
Length of cord	Approx. 1800 mm (5 ft. 11 in.)
Weight	Approx. 80 g (2.8 oz.), excluding power cable

EN-EL3e rechargeable Li-ion battery	
Type	Rechargeable lithium-ion battery
Rated capacity	7.4 V/1500 mAh
Dimensions (W × H × D)	Approx. 39.5 × 56 × 21 mm (1.6 × 2.2 × 0.8 in.)
Weight	Approx. 80 g (2.8 oz.), excluding terminal cover



AF-S DX NIKKOR 18–105 mm f/3.5–5.6G ED VR lens

Type	G-type AF-S DX Zoom-NIKKOR VR lens with built-in CPU and Nikon bayonet mount
Supported cameras	Nikon digital SLR cameras (DX format)
Focal length	18–105 mm
Maximum aperture	f/3.5–5.6
Construction	15 elements in 11 groups (including 1 ED glass element and 1 aspherical element)
Picture angle	76°–15° 20′
Focal length scale (mm)	18, 24, 35, 50, 75, 105
Distance information	Output to camera
Zoom control	Zoom adjusted by rotating separate zoom ring
Focusing	Autofocus with Silent Wave Motor; manual focus; manual focus supported when A-M switch is set to A or M. Focus can be adjusted by rotating lens focusing ring after locking focus in single-servo autofocus. Do not use focusing ring while camera is focusing.
Vibration reduction	Lens-shift method using voice coil motors (VCMs)
Closest focus distance	0.45 m (1 ft. 5.7 in.) at all zoom settings
Diaphragm	Seven-blade diaphragm with rounded blades and fully automatic aperture
Aperture range	f/3.5–22 at 18 mm; f/5.6–38 at 105 mm
Metering	Maximum aperture
Attachment size	67 mm (P=0.75 mm)
Dimensions	Approx. 76 mm diameter × 89 mm/3.0 × 3.5 in. (from surface of bayonet mount to end of lens)
Weight	Approx. 420 g (14.8 oz.)
Lens hood	HB-32 (available separately; attaches as shown below)



The following accessories can not be used: teleconverters (all types), PK auto extension rings (all types), K rings (all types), BR-4 auto rings, bellow attachments (all types), and SX-1 attachment rings. Other accessories may also be incompatible. See the accessory manual for details.

■ ■ *Supported Standards*

- **DCF Version 2.0:** The Design Rule for Camera File Systems (DCF) is a standard widely used in the digital camera industry to ensure compatibility among different makes of camera.
- **DPOF:** Digital Print Order Format (DPOF) is an industry-wide standard that allows pictures to be printed from print orders stored on the memory card.
- **Exif version 2.21:** The D90 supports Exif (Exchangeable Image File Format for Digital Still Cameras) version 2.21, a standard in which information stored with photographs is used for optimal color reproduction when the images are output on Exif-compliant printers.
- **PictBridge:** A standard developed through cooperation with the digital camera and printer industries, allowing photographs to be output directly to a printer without first transferring them to a computer.
- **HDMI: High-Definition Multimedia Interface** is a standard for multimedia interfaces used in consumer electronics and AV devices capable of transmitting audiovisual data and control signals to HDMI-compliant devices via a single cable connection.



✔ Battery Life

The number of shots that can be taken with fully-charged batteries varies with the condition of the battery, temperature, and how the camera is used. In the case of AA batteries, capacity also varies with make and storage conditions; some batteries can not be used. Sample figures for the camera and optional MB-D80 multi-power battery pack are given below.

• CIPA standard ¹

One EN-EL3e battery (camera): Approximately 850 shots

One EN-EL3e battery (MB-D80): Approximately 850 shots

Two EN-EL3e batteries (MB-D80): Approximately 1700 shots

six AA batteries (MB-D80): Approximately 600 shots

• Nikon standard ²


One EN-EL3e battery (camera): Approximately 4200 shots

One EN-EL3e battery (MB-D80): Approximately 4200 shots

Two EN-EL3e batteries (MB-D80): Approximately 8400 shots

six AA batteries (MB-D80): Approximately 1900 shots

1 Measured at 23 °C/73.4 °F (±2 °C/3.6 °F) with an AF-S DX NIKKOR 18–105mm f/3.5–5.6G ED VR lens under the following test conditions: lens cycled from infinity to minimum range and one photograph taken at default settings once every 30 s; after photograph is taken, monitor is turned on for 4 s; tester waits for exposure meters to turn off after monitor is turned off; flash fired at full power once every other shot. Live view not used.

2 Measured at 20 °C/68 °F with an AF-S DX NIKKOR 18–105mm f/3.5–5.6G ED VR lens under the following test conditions: release mode set to , autofocus mode set to **AF-C**, image quality set to JPEG basic, image size set to **M** (medium), white balance set to **A**, ISO sensitivity set to ISO 200, shutter speed $\frac{1}{250}$ s, focus cycled from infinity to minimum range three times after exposure meters have been on for 3 s; six shots are then taken in succession and monitor turned on for 4 s and then turned off; cycle repeated once exposure meters have turned off.

The following can reduce battery life:

- Using the monitor
- Keeping the shutter-release button pressed halfway
- Repeated autofocus operations
- Taking NEF (RAW) photographs
- Slow shutter speeds
- Using VR (vibration reduction) mode with VR lenses

To ensure that you get the most from rechargeable Nikon EN-EL3e batteries:

- Keep the battery contacts clean. Soiled contacts can reduce battery performance.
- Use batteries immediately after charging. Batteries will lose their charge if left unused.



Index

Menu items and options in the camera monitor are shown in bold.

Symbols

- switch**, 196
- (Auto mode), 34
- (Auto (flash off) mode), 34
- (Portrait), 41
- (Landscape), 41
- (Close up), 42
- (Sports), 42
- (Night portrait), 42
- P** (Programmed auto), 80
- S** (Shutter-priority auto), 81
- A** (Aperture-priority auto), 82
- M** (Manual), 83
- (flexible program), 80
- (Single frame), 64
- (Continuous low speed), 64, 65, 182
- (Continuous high speed), 64, 65
- (Self-timer), 66, 179
- (Remote control), 68
- (Live view), 43
- (Matrix), 87
- (Center-weighted), 27
- (Spot), 87
- (flash-ready indicator), 9, 40
- (FV lock), 198
- (Bracketing indicator), 92, 191, 193
- (White balance), 95
- (White Balance Bracketing), 191
- PRE** (Preset manual), 100
- (Exposure Compensation), 90
- (Flash Compensation), 91
- (“Clock not set” indicator), 28
- (“Beep” indicator), 180

Numerics

- 3D color matrix metering II, 87
- 3D-tracking, 173
- 420-segment RGB sensor, 87

A

- AC adapter, 239
- Accessories, 239
- Active D-Lighting**, 119
- Active folder**, 169
- adjustment control, 32
- AE-L, 88
- AE-L**, 200
- AE-L/AF-L button, 88
- AE-L/AF-L button, 200
- AE-L/AF-L for MB-D80**, 176
- AF, 54–56
- AF assist, 38, 174, 231
- AF point illumination**, 175

- AF-area mode, 57, 173
 - 3D-tracking(11 points), 56, 173
 - auto-area, 36, 173
 - dynamic-area, 56, 173
 - single-point, 56, 173

AF-area mode

- A-M switch, 25
- Amber, 97, 216
- Aperture, 79
 - maximum, 60
 - minimum, 26, 78
- Aperture-priority auto, 82
- Assign AE-L/AF-L button**, 200
- Assign FUNC. button**, 197

- Audio video cable, 146
- Auto bracketing, 92, 191, 193

Auto bracketing set

- ADL bracketing**, 193
- AE & flash**, 191
- AE only**, 191
- Flash only**, 191
- WB bracketing**, 191

Auto FP

- Auto image rotation**, 205
- Auto meter off, 35, 179
- Auto meter-off delay**, 179
- Auto-area, 36, 173
- Autofocus, 54, 55, 57

B

- Backlight, 8, 183
- Battery, 22, 23, 34, 184, 208
 - charging, 22
 - pack, 184, 208, 239

Battery info

- Beep**, 180
- Blue, 97
- Body cap, 3, 25, 240
- Bracketing, 92, 191, 193
 - Active D-Lighting, 193
 - exposure, 92
 - flash, 92
 - white balance, 191

Bracketing order

- Built-in AF-assist illuminator**, 174
- Bulb, 85
- Burst, 122

C

- Calendar, 136
- Camera Control Pro 2, 148, 240
- Center focus point**, 174
- Center-weighted area**, 9, 178
- CL mode shooting speed**, 182
- Clean image sensor**, 244

- Clock, 27, 204
 - battery, 28, 204

CLS

Color balance

- Color space**, 167
 - Adobe RGB**, 167
 - sRGB**, 167

Color temperature

- Computer, 148
- Control Panel, 7
- CPU contacts, 228
- CPU lens, 26, 229
- Creative Lighting System, 233
- Custom Settings, 171
- Customize command dials**, 201

D

- Date and time, 27, 204
- Daylight saving time, 27, 204
- DCF version 2.0, 167, 274
- Default settings, 75, 172, 260
 - restoring, 75, 172
- Delete, 49, 140, 162
 - all images, 162
 - current image, 49, 140
 - selected images, 162

Delete

- All**, 162
- Select date**, 162
- Selected**, 162

Depth-of-field

- Depth-of-field preview button, 82, 191

Digital Print Order Format

- 153, 157, 274

Dioptr

- 32, 239

Display mode

Distortion control

- 222

D-Lighting

- 150, 153, 157, 274

Dynamic-area

- 56, 173

E

Easy exposure compensation

- 177
- Electronic analog exposure display, 84
- EV steps for exposure cntrl.**, 177
- Exif version 2.21, 167, 274
- Exposure, 79, 88, 90
 - lock, 88
 - meters, 178
 - mode, 78

- aperture-priority auto, 82

- manual, 83

- programmed auto, 80

shutter-priority auto, 81
program, 263
Exposure bracketing, 92, 191, 195
Exposure compensation, 90, 177
Exposure delay mode, 183
F
File information, 129
File number sequence, 182
Filter effects, 215
 Blue intensifier, 215
 Cross screen, 215
 Green intensifier, 215
 Red intensifier, 215
 Skylight, 215
 Warm filter, 215
Fine tune optimal exposure, 178
Firmware version, 208
Fisheye, 222
Flash, 40, 70, 71, 233
 bracketing, 92
 compensation, 91
 control, 233, 265
 i-TTL balanced-fill flash for digital SLR, 265
 standard i-TTL flash for digital SLR, 265
 mode, 71, 185
 modeling, 191
 monitor pre-flash, 233
 range, 266
 ready indicator, 198, 237
 sync speed, 185
 sync terminal, 238
Flash ctrl for built-in flash, 185
 Commander mode, 188
 Manual, 187
 Repeating flash, 187
Flash shutter speed, 185
Flash Warning, 183
Flexible program, 80
Fn button, 197, 198
f-number, 82, 228
Focal length, 228
Focal length scale, 25
Focal plane mark, 60
Focus, 54, 55, 57, 59
 autofocus, 54, 55, 57
 electronic rangefinder, 60, 229
 indicator, 38, 57, 60
 lock, 57
 Manual focus, 59
 mode, 54
 Auto select, 36, 54
 continuous-servo AF, 54
 selector, 54, 59
 single-servo AF, 54
 point, 45, 54, 57, 173, 174, 175

tracking, 56, 173
 3D, 56, 173
Focus point wrap-around, 175
Focusing screen, 267
Format, 30, 202
Format memory card, 202
Front-curtain sync, 71
FV lock, 198
G
GPS, 124, 133, 241
 connecting, 124
 data, 133
GPS, 124
 Green, 97
H
H (Sensitivity), 74
HDMI, 147, 203, 274
HDMI, 203
Help, 18, 21
Hide image, 162
High definition, 147, 203, 274
High ISO NR, 168
Highlights, 131, 163
Histogram, 130, 163
I
Image comment, 205
Image Dust Off ref photo, 206
Image file, 274
Image overlay, 218
Image quality, 62
Image review, 163
Image size, 63
Index print, 156
In-focus indicator, 38, 57, 60
Information, 129, 163
ISO display and adjustment, 181
ISO sensitivity, 74, 166
ISO sensitivity, 74
ISO sensitivity auto control, 166
 Maximum sensitivity, 166
 Minimum shutter speed, 166
ISO sensitivity settings, 166
i-TTL, 188, 233, 265
J
JPEG, 61, 62
JPEG basic, 62
JPEG fine, 62
JPEG normal, 36, 62
L
L (Image size), 36, 63
L (Sensitivity), 74
Language, 27, 204
LCD, 8, 183, 202
LCD brightness, 202
LCD illumination, 183
Lens, 25, 26, 228
 attaching, 25
 cap, 25

cap, rear, 25
compatible, 228
CPU, 26, 229
focus mode switch, 25
focus ring, 25
mounting index, 25
non-CPU, 230
removing, 26
type D, 228
type G, 228
VR switch, 25
Lens mount, 3, 60
Live view, 43, 50, 176
Live view autofocus, 176
 Face priority, 176
 Normal area, 176
 Wide area, 176
Lock mirror up for cleaning, 246
Long exp. NR, 167
Long time-exposure with remote control, 85
M
M (Image size), 63
Magenta, 97, 216
Manage Picture Control, 113
Manual, 45, 59, 83
Manual focus, 45, 59
Matrix, 87
MB-D80, 184, 208, 239
MB-D80 battery type, 184
Memory buffer, 38, 64
Memory card, 29, 202, 242
 capacity of, 262
 formatting, 30, 202
Metering
 center-weighted, 87
 matrix, 87
 spot, 87
Mired, 98
Mirror, 4, 246
 lock up for cleaning, 246
Modeling flash, 191
Monitor, 5, 43, 128, 202
 cover, 17
Monitor off delay, 180
Monochrome, 214
 Black-and-white, 214
 Cyanotype, 214
 Sepia, 214
Mounting index, 25
Movie settings, 170
 Quality, 170
 Sound, 170
Movies, 50
Multiple exposure, 121
MY MENU, 224
 Add items, 225
 Rank items, 226

Remove items, 225

N

NEF, 62

NEF (RAW), 62, 148, 220

NEF (RAW) processing, 220

Nikon Transfer, 148, 149

No memory card?, 201

O

OK button (shooting mode), 196

Optional flash, 185

Overview data, 134

P

Photo info, 129, 163

PictBridge, 150, 274

Pictmotion, 141

Picture angle, 228

Picture Controls, 108

Playback, 48, 128

calendar, 136

folder, 162

full-frame, 128

information, 129, 163

menu, 160

Pictmotion, 141

slide show, 143

thumbnail, 135

zoom, 138

Playback folder, 162

Preset Manual, 100

Print (DPOF), 153

Border, 155

Page size, 155

Start printing, 155

Time stamp, 155

Print select, 153

Border, 155

Page size, 155

Start printing, 155

Time stamp, 155

Print set (DPOF), 150

Printing, 150

Programmed auto, 80

Protecting photographs, 139

Q

Quick retouch, 221

Quick Settings Display, 12

R

Rear-curtain sync, 71

Recent settings, 224

Red-eye correction, 212

Red-eye reduction, 71

Release mode, 64

continuous, 64, 65

high speed, 64, 65

low speed, 64, 65, 182

delayed remote, 68

Quick-response remote, 68

self-timer, 66

single-frame, 64

Remote Control, 64, 68, 241

Remote cord, 85, 241

Remote on duration, 180

Reset, 75, 172, 260

Reset custom settings, 172

Reverse indicators, 201

RGB, 130, 167

RGB Histogram, 130

Rotate tall, 163

S

S (Image size), 63

Screen tips, 182

Self-timer, 179

Sensitivity, 74, 166

Set Picture Control, 109

Landscape, 109

Monochrome, 109

Filter effects, 111, 112

Toning, 111, 112

Neutral, 109

Portrait, 109

Standard, 109

Vivid, 109

Setup menu, 202

Shooting data, 131, 132

Shooting info display, 10, 183

Shooting menu, 165

Shutter-priority auto, 81

Shutter-release button, 38, 39, 57, 88, 179

half press, 38, 88

Shutter-release button AE-L, 179

Side-by-side comparison, 223

Single-point, 56, 173

Size, 63

Slide show, 143

Frame interval, 143

Slow sync, 71

Small picture, 216

Speedlight, 233

Spot, 87

Straighten, 221

T

Television, 146

Thumbnail, 135

Timer, 66

Trim, 213

Turn, 27

Two-button reset, 75

U

USB, 149, 151

cable, 149, 151

UTC, 27, 124, 133

V

Vibration Reduction, 26

Video, 146, 203

cable, 146

mode, 203

Video mode, 203

Viewfinder, 9, 32, 66, 267

eyepiece, 32, 66

eyepiece cap, 17, 66

focus, 32, 59

Viewfinder grid display, 181

Viewfinder warning display, 181

ViewNX, 148

W

WB, 95, 191

White balance, 95, 191

bracketing, 191

preset manual, 95

White balance, 95

Auto, 95

Choose color temp., 95, 99

Cloudy, 95

Direct sunlight, 95

Flash, 95

Fluorescent, 95

Incandescent, 95

Preset manual, 95, 100

Shade, 95

World time, 27, 204

Date and time, 27, 204

Date format, 28, 204

Daylight saving time, 27, 204

Time zone, 27, 204

Nikon

No reproduction in any form of this manual, in whole or in part (except for brief quotation in critical articles or reviews), may be made without written authorization from NIKON CORPORATION.

NIKON CORPORATION

Fuji Bldg., 2-3 Marunouchi 3-chome,
Chiyoda-ku, Tokyo 100-8331, Japan

© 2008 Nikon Corporation



Printed in Europe
SB8H01(11)
6MB03011-01